

PHASE CONTROL THYRISTORS

Hockey Puk Version

Features

- Center amplifying gate
- Metal case with ceramic insulator
- International standard case A-24 (K-PUK)
- High profile hockey-puk

Typical Applications

- DC motor controls
- Controlled DC power supplies
- AC controllers

Major Ratings and Characteristics

| Parameters | ST1200C..K | Units |
|-------------------|---------------|-------------------|
| $I_{T(AV)}$ | 1650 | A |
| | @ T_{hs} 55 | °C |
| $I_{T(RMS)}$ | 3080 | A |
| | @ T_{hs} 25 | °C |
| I_{TSM} | @ 50Hz 30500 | A |
| | @ 60Hz 32000 | A |
| I^2t | @ 50Hz 4651 | KA ² s |
| | @ 60Hz 4250 | KA ² s |
| V_{DRM}/V_{RRM} | 1200 to 2000 | V |
| t_q typical | 200 | μs |
| T_J | - 40 to 125 | °C |

1650A

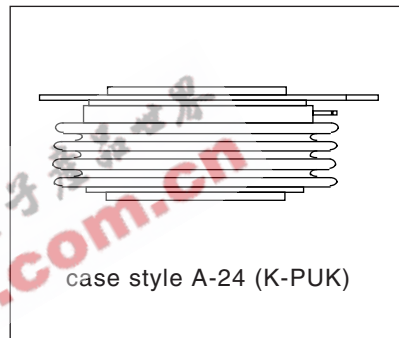

ST1200C..K Series

Bulletin I25196 rev.B 01/00

International
IRF Rectifier

ELECTRICAL SPECIFICATIONS

Voltage Ratings

| Type number | Voltage Code | V_{DRM}/V_{RRM} , max. repetitive peak and off-state voltage V | V_{RSM} , maximum non-repetitive peak voltage V | I_{DRM}/I_{RRM} max. @ $T_J = T_J$ max mA |
|-------------|--------------|---|--|---|
| ST1200C..K | 12 | 1200 | 1300 | 100 |
| | 14 | 1400 | 1500 | |
| | 16 | 1600 | 1700 | |
| | 18 | 1800 | 1900 | |
| | 20 | 2000 | 2100 | |

On-state Conduction

| Parameter | ST1200C..K | Units | Conditions | |
|--|------------|--------------------|--|-----------------------|
| $I_{T(AV)}$ Max. average on-state current @ Heatsink temperature | 1650 (700) | A | 180° conduction, half sine wave double side (single side) cooled | |
| | 55 (85) | °C | | |
| $I_{T(RMS)}$ Max. RMS on-state current | 3080 | A | DC @ 25°C heatsink temperature double side cooled | |
| I_{TSM} Max. peak, one-cycle non-repetitive surge current | 30500 | | t = 10ms | No voltage reappplied |
| | 32000 | | t = 8.3ms | reappplied |
| | 25700 | | t = 10ms | 100% V_{RRM} |
| | 26900 | | t = 8.3ms | reappplied |
| I^2t Maximum I^2t for fusing | 4651 | KA ² s | t = 10ms | No voltage reappplied |
| | 4250 | | t = 8.3ms | reappplied |
| | 3300 | | t = 10ms | 100% V_{RRM} |
| | 3000 | | t = 8.3ms | reappplied |
| $I^2\sqrt{t}$ Maximum $I^2\sqrt{t}$ for fusing | 46510 | KA ² /s | t = 0.1 to 10ms, no voltage reappplied | |
| $V_{T(TO)1}$ Low level value of threshold voltage | 0.91 | V | $(16.7\% \times \pi \times I_{T(AV)} < I < \pi \times I_{T(AV)})$, $T_J = T_J$ max. | |
| $V_{T(TO)2}$ High level value of threshold voltage | 1.01 | | $(I > \pi \times I_{T(AV)})$, $T_J = T_J$ max. | |
| r_{t1} Low level value of on-state slope resistance | 0.21 | mΩ | $(16.7\% \times \pi \times I_{T(AV)} < I < \pi \times I_{T(AV)})$, $T_J = T_J$ max. | |
| r_{t2} High level value of on-state slope resistance | 0.19 | | $(I > \pi \times I_{T(AV)})$, $T_J = T_J$ max. | |
| V_{TM} Max. on-state voltage | 1.73 | V | $I_{pk} = 4000A$, $T_J = T_J$ max, $t_p = 10ms$ sine pulse | |
| I_H Maximum holding current | 600 | mA | $T_J = 25^\circ C$, anode supply 12V resistive load | |
| I_L Typical latching current | 1000 | | | |

Switching

| Parameter | ST1200C..K | Units | Conditions |
|---|------------|-------|---|
| di/dt Max. non-repetitive rate of rise of turned-on current | 1000 | A/μs | Gate drive 20V, 20Ω, $t_r \leq 1\mu s$ $T_J = T_J \text{ max}$, anode voltage $\leq 80\% V_{DRM}$ |
| t_d Typical delay time | 1.9 | μs | Gate current 1A, $di_g/dt = 1A/\mu s$ $V_d = 0.67\% V_{DRM}$, $T_J = 25^\circ C$ |
| t_q Typical turn-off time | 200 | | $I_{TM} = 550A$, $T_J = T_J \text{ max}$, $di/dt = 40A/\mu s$, $V_R = 50V$ $dv/dt = 20V/\mu s$, Gate 0V 100Ω, $t_p = 500\mu s$ |

Blocking

| Parameter | ST1200C..K | Units | Conditions |
|--|------------|-------|---|
| dv/dt Maximum critical rate of rise of off-state voltage | 500 | V/μs | $T_J = T_J \text{ max}$. linear to 80% rated V_{DRM} |
| I_{RRM} I_{DRM} Max. peak reverse and off-state leakage current | 100 | mA | $T_J = T_J \text{ max}$, rated V_{DRM}/V_{RRM} applied |

Triggering

| Parameter | ST1200C..K | | Units | Conditions |
|--|------------|------|-------|---|
| P_{GM} Maximum peak gate power | 16 | | W | $T_J = T_J \text{ max}$, $t_p \leq 5ms$ |
| $P_{G(AV)}$ Maximum average gate power | 3 | | | |
| I_{GM} Max. peak positive gate current | 3.0 | | A | $T_J = T_J \text{ max}$, $t_p \leq 5ms$ |
| $+V_{GM}$ Maximum peak positive gate voltage | 20 | | V | $T_J = T_J \text{ max}$, $t_p \leq 5ms$ |
| $-V_{GM}$ Maximum peak negative gate voltage | 5.0 | | | |
| I_{GT} DC gate current required to trigger | TYP. | MAX. | mA | $T_J = -40^\circ C$ $T_J = 25^\circ C$ $T_J = 125^\circ C$ Max. required gate trigger/ current/ voltage are the lowest value which will trigger all units 12V anode-to-cathode applied |
| | 200 | - | | |
| | 100 | 200 | | |
| V_{GT} DC gate voltage required to trigger | 1.4 | - | V | $T_J = -40^\circ C$ $T_J = 25^\circ C$ $T_J = 125^\circ C$ |
| | 1.1 | 3.0 | | |
| | 0.9 | - | | |
| I_{GD} DC gate current not to trigger | 10 | | mA | $T_J = T_J \text{ max}$ Max. gate current/voltage not to trigger is the max. value which will not trigger any unit with rated V_{DRM} anode-to-cathode applied |
| V_{GD} DC gate voltage not to trigger | 0.25 | | V | |

ST1200C..K Series

Bulletin I25196 rev.B 01/00

International
IRF Rectifier

Thermal and Mechanical Specification

| Parameter | ST1200C..K | Units | Conditions |
|---|-----------------|-----------|--|
| T _J Max. operating temperature range | -40 to 125 | °C | |
| T _{stg} Max. storage temperature range | -40 to 150 | | |
| R _{thJ-hs} Max. thermal resistance, junction to heatsink | 0.042 0.021 | K/W | DC operation single side cooled DC operation double side cooled |
| R _{thC-hs} Max. thermal resistance, case to heatsink | 0.006 0.003 | K/W | DC operation single side cooled DC operation double side cooled |
| F Mounting force, ± 10% | 24500 (2500) | N (Kg) | |
| wt Approximate weight | 425 | g | |
| Case style | A-24 (K-PUK) | | See Outline Table |

ΔR_{thJ-hs} Conduction

(The following table shows the increment of thermal resistance R_{thJ-hs} when devices operate at different conduction angles than DC)

| Conduction angle | Sinusoidal conduction | | Rectangular conduction | | Units | Conditions |
|------------------|-----------------------|-------------|------------------------|-------------|-------|--------------------------------------|
| | Single Side | Double Side | Single Side | Double Side | | |
| 180° | 0.003 | 0.003 | 0.002 | 0.002 | K/W | T _J = T _J max. |
| 120° | 0.004 | 0.004 | 0.004 | 0.004 | | |
| 90° | 0.005 | 0.005 | 0.005 | 0.005 | | |
| 60° | 0.007 | 0.007 | 0.007 | 0.007 | | |
| 30° | 0.012 | 0.012 | 0.012 | 0.012 | | |

Ordering Information Table

| Device Code | | | | | | | |
|-------------|--|---|---|----|---|---|---|
| 1 | 2 | 3 | 4 | 5 | 6 | 7 | 8 |
| ST | 120 | 0 | C | 20 | K | 1 | |
| 1 | - Thyristor | | | | | | |
| 2 | - Essential part number | | | | | | |
| 3 | - 0 = Converter grade | | | | | | |
| 4 | - C = Ceramic Puk | | | | | | |
| 5 | - Voltage code: Code x 100 = V _{RRM} (See Voltage Rating Table) | | | | | | |
| 6 | - K = Puk Case A-24 (K-PUK) | | | | | | |
| 7 | - 0 = Eyelet terminals (Gate and Auxiliary Cathode Unsoldered Leads) 1 = Fast-on terminals (Gate and Auxiliary Cathode Unsoldered Leads) 2 = Eyelet terminals (Gate and Auxiliary Cathode Soldered Leads) 3 = Fast-on terminals (Gate and Auxiliary Cathode Soldered Leads) | | | | | | |
| 8 | - Critical dv/dt: None = 500V/μsec (Standard selection) L = 1000V/μsec (Special selection) | | | | | | |

Outline Table

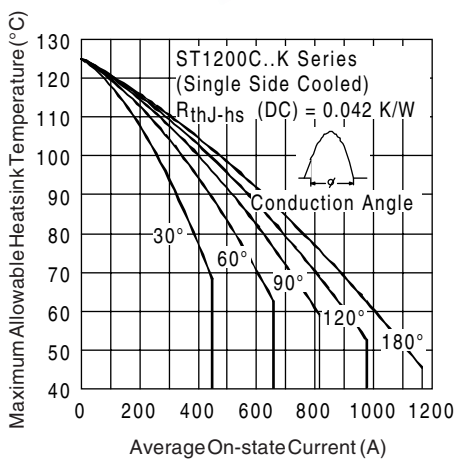
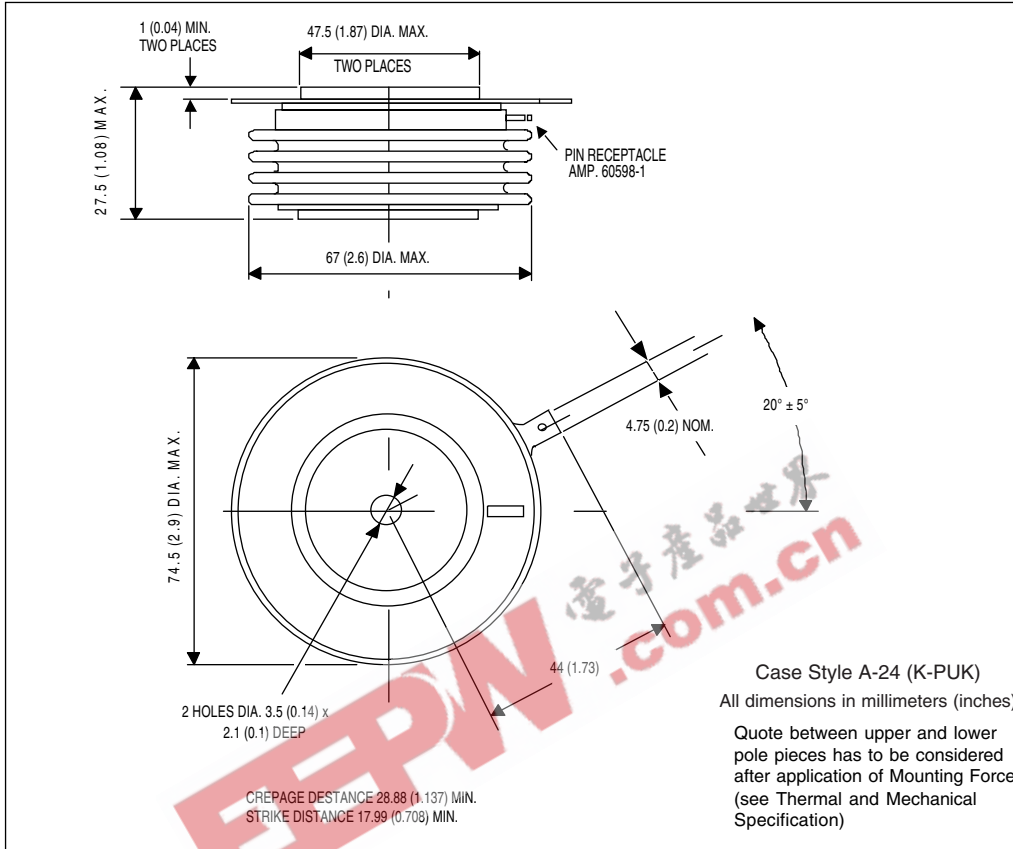

Fig. 1 - Current Ratings Characteristics

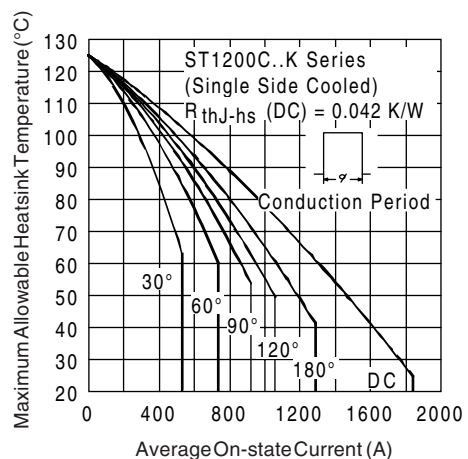

Fig. 2 - Current Ratings Characteristics

ST1200C..K Series

Bulletin I25196 rev. B 01/00

International
IRF Rectifier

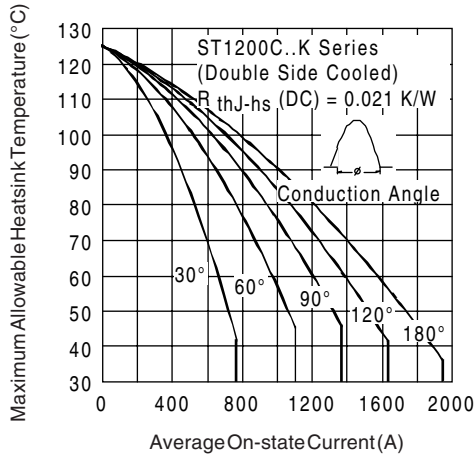

Fig. 3 - Current Ratings Characteristics

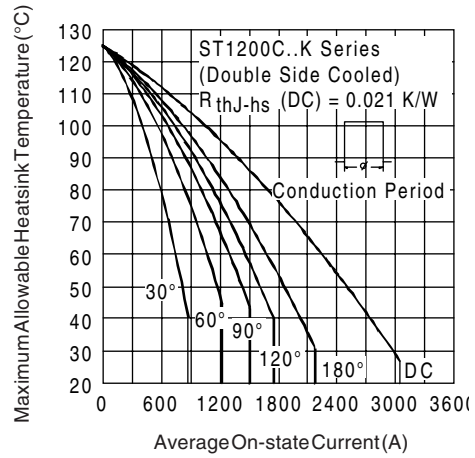

Fig. 4 - Current Ratings Characteristics

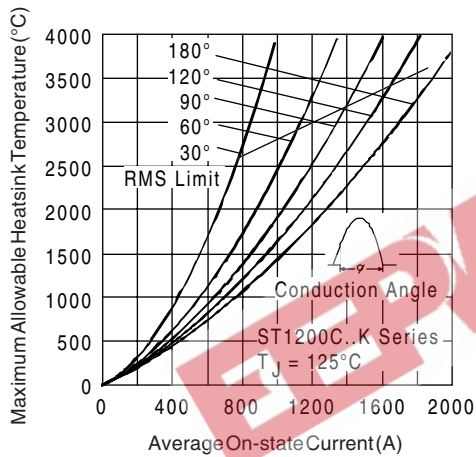

Fig. 5 - On-state Power Loss Characteristics

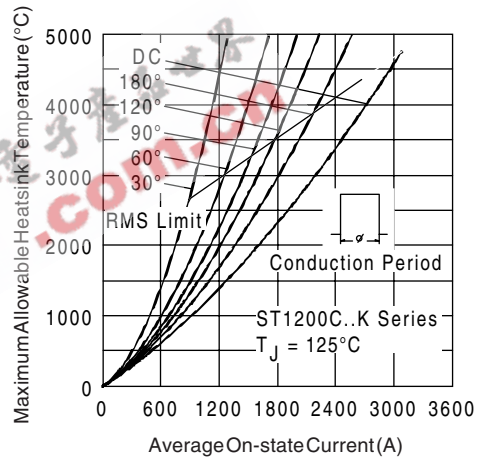

Fig. 6 - On-state Power Loss Characteristics

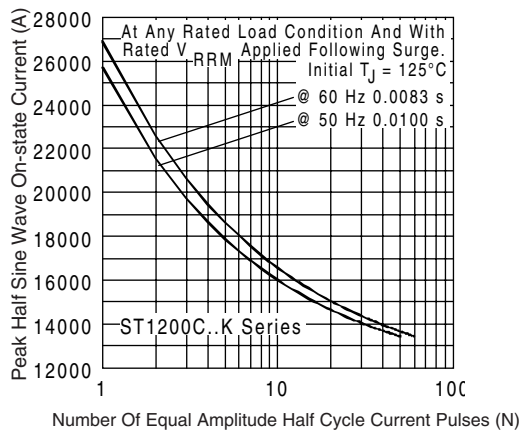

Fig. 7 - Maximum Non-Repetitive Surge Current Single and Double Side Cooled

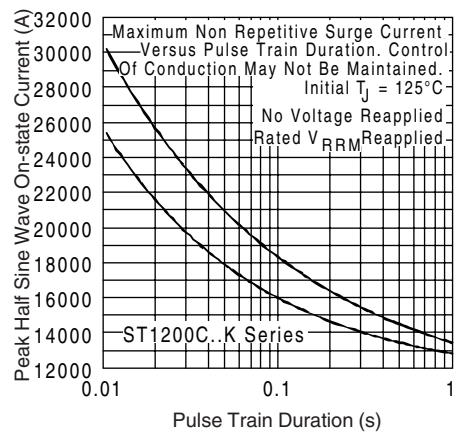

Fig. 8 - Maximum Non-Repetitive Surge Current Single and Double Side Cooled

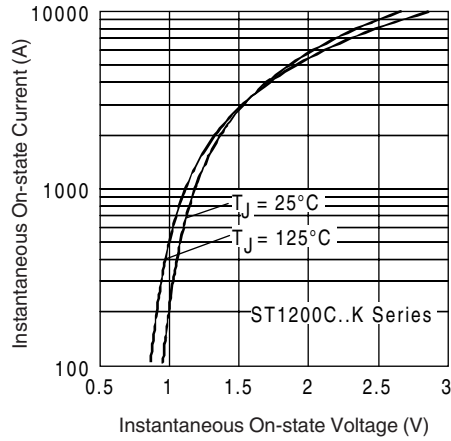

Fig. 9 - On-state Voltage Drop Characteristics

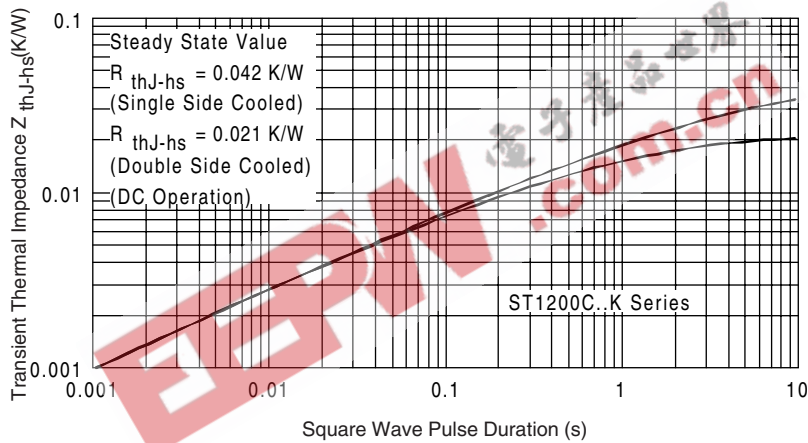

Fig. 10 - Thermal Impedance Z_{thJ-hs} Characteristics

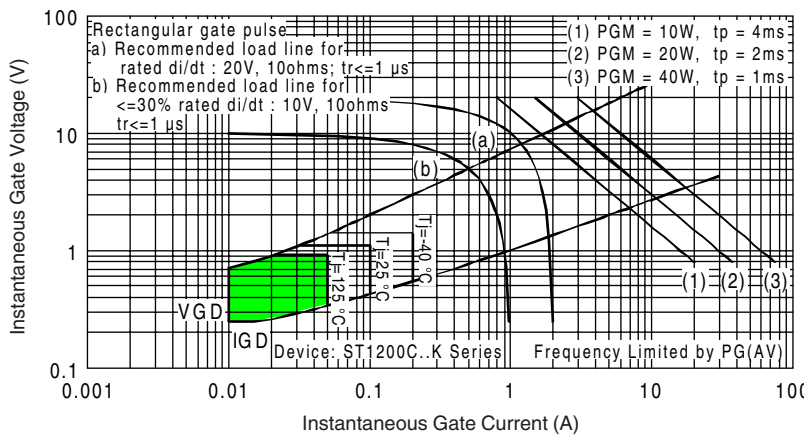

Fig. 11 - Gate Characteristics