

## PHASE CONTROL THYRISTORS

## Hockey Puk Version

### Features

- Center amplifying gate
- Metal case with ceramic insulator
- International standard case A-24 (K-PUK)
- High profile hockey-puk

### Typical Applications

- DC motor controls
- Controlled DC power supplies
- AC controllers

### Major Ratings and Characteristics

Parameters	ST1200C..K	Units
$I_{T(AV)}$	1650	A
	@ $T_{hs}$ 55	°C
$I_{T(RMS)}$	3080	A
	@ $T_{hs}$ 25	°C
$I_{TSM}$	@ 50Hz 30500	A
	@ 60Hz 32000	A
$I^2t$	@ 50Hz 4651	KA <sup>2</sup> s
	@ 60Hz 4250	KA <sup>2</sup> s
$V_{DRM}/V_{RRM}$	1200 to 2000	V
$t_q$ typical	200	μs
$T_J$	- 40 to 125	°C

1650A

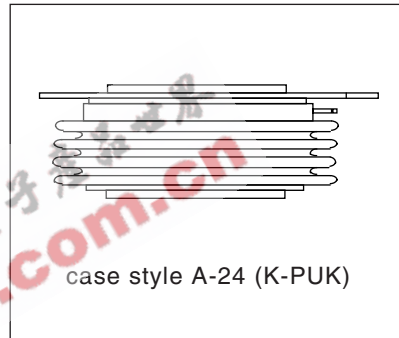

## ST1200C..K Series

Bulletin I25196 rev.B 01/00

International  
IRF Rectifier

### ELECTRICAL SPECIFICATIONS

#### Voltage Ratings

Type number	Voltage Code	$V_{DRM}/V_{RRM}$ , max. repetitive peak and off-state voltage V	$V_{RSM}$ , maximum non-repetitive peak voltage V	$I_{DRM}/I_{RRM}$ max. @ $T_J = T_J$ max mA
ST1200C..K	12	1200	1300	100
	14	1400	1500	
	16	1600	1700	
	18	1800	1900	
	20	2000	2100	

#### On-state Conduction

Parameter	ST1200C..K	Units	Conditions	
$I_{T(AV)}$ Max. average on-state current @ Heatsink temperature	1650 (700)	A	180° conduction, half sine wave double side (single side) cooled	
	55 (85)	°C		
$I_{T(RMS)}$ Max. RMS on-state current	3080	A	DC @ 25°C heatsink temperature double side cooled	
$I_{TSM}$ Max. peak, one-cycle non-repetitive surge current	30500		t = 10ms	No voltage reappplied
	32000		t = 8.3ms	reappplied
	25700		t = 10ms	100% $V_{RRM}$
	26900		t = 8.3ms	reappplied
$I^2t$ Maximum $I^2t$ for fusing	4651	KA <sup>2</sup> s	t = 10ms	No voltage reappplied
	4250		t = 8.3ms	reappplied
	3300		t = 10ms	100% $V_{RRM}$
	3000		t = 8.3ms	reappplied
$I^2\sqrt{t}$ Maximum $I^2\sqrt{t}$ for fusing	46510	KA <sup>2</sup> /s	t = 0.1 to 10ms, no voltage reappplied	
$V_{T(TO)1}$ Low level value of threshold voltage	0.91	V	$(16.7\% \times \pi \times I_{T(AV)} < I < \pi \times I_{T(AV)})$ , $T_J = T_J$ max.	
$V_{T(TO)2}$ High level value of threshold voltage	1.01		$(I > \pi \times I_{T(AV)})$ , $T_J = T_J$ max.	
$r_{t1}$ Low level value of on-state slope resistance	0.21	mΩ	$(16.7\% \times \pi \times I_{T(AV)} < I < \pi \times I_{T(AV)})$ , $T_J = T_J$ max.	
$r_{t2}$ High level value of on-state slope resistance	0.19		$(I > \pi \times I_{T(AV)})$ , $T_J = T_J$ max.	
$V_{TM}$ Max. on-state voltage	1.73	V	$I_{pk} = 4000A$ , $T_J = T_J$ max, $t_p = 10ms$ sine pulse	
$I_H$ Maximum holding current	600	mA	$T_J = 25^\circ C$ , anode supply 12V resistive load	
$I_L$ Typical latching current	1000			

Switching

Parameter	ST1200C..K	Units	Conditions
di/dt Max. non-repetitive rate of rise of turned-on current	1000	A/μs	Gate drive 20V, 20Ω, $t_r \leq 1\mu s$ $T_J = T_J \text{ max}$ , anode voltage $\leq 80\% V_{DRM}$
$t_d$ Typical delay time	1.9	μs	Gate current 1A, $di_g/dt = 1A/\mu s$ $V_d = 0.67\% V_{DRM}$ , $T_J = 25^\circ C$
$t_q$ Typical turn-off time	200		$I_{TM} = 550A$ , $T_J = T_J \text{ max}$ , $di/dt = 40A/\mu s$ , $V_R = 50V$ $dv/dt = 20V/\mu s$ , Gate 0V 100Ω, $t_p = 500\mu s$

Blocking

Parameter	ST1200C..K	Units	Conditions
dv/dt Maximum critical rate of rise of off-state voltage	500	V/μs	$T_J = T_J \text{ max}$ . linear to 80% rated $V_{DRM}$
$I_{RRM}$ $I_{DRM}$ Max. peak reverse and off-state leakage current	100	mA	$T_J = T_J \text{ max}$ , rated $V_{DRM}/V_{RRM}$ applied

Triggering

Parameter	ST1200C..K		Units	Conditions
$P_{GM}$ Maximum peak gate power	16		W	$T_J = T_J \text{ max}$ , $t_p \leq 5ms$
$P_{G(AV)}$ Maximum average gate power	3			
$I_{GM}$ Max. peak positive gate current	3.0		A	$T_J = T_J \text{ max}$ , $t_p \leq 5ms$
$+V_{GM}$ Maximum peak positive gate voltage	20		V	$T_J = T_J \text{ max}$ , $t_p \leq 5ms$
$-V_{GM}$ Maximum peak negative gate voltage	5.0			
$I_{GT}$ DC gate current required to trigger	TYP.	MAX.	mA	$T_J = -40^\circ C$ $T_J = 25^\circ C$ $T_J = 125^\circ C$  Max. required gate trigger/ current/ voltage are the lowest value which will trigger all units 12V anode-to-cathode applied
	200	-		
	100	200		
$V_{GT}$ DC gate voltage required to trigger	1.4	-	V	$T_J = -40^\circ C$ $T_J = 25^\circ C$ $T_J = 125^\circ C$
	1.1	3.0		
	0.9	-		
$I_{GD}$ DC gate current not to trigger	10		mA	Max. gate current/voltage not to trigger is the max. value which will not trigger any unit with rated $V_{DRM}$ anode-to-cathode applied
$V_{GD}$ DC gate voltage not to trigger	0.25		V	

## ST1200C..K Series

Bulletin I25196 rev.B 01/00

International  
IRF Rectifier

### Thermal and Mechanical Specification

Parameter	ST1200C..K	Units	Conditions
T <sub>J</sub> Max. operating temperature range	-40 to 125	°C	
T <sub>stg</sub> Max. storage temperature range	-40 to 150		
R <sub>thJ-hs</sub> Max. thermal resistance, junction to heatsink	0.042 0.021	K/W	DC operation single side cooled DC operation double side cooled
R <sub>thC-hs</sub> Max. thermal resistance, case to heatsink	0.006 0.003	K/W	DC operation single side cooled DC operation double side cooled
F Mounting force, ± 10%	24500 (2500)	N (Kg)	
wt Approximate weight	425	g	
Case style	A-24 (K-PUK)		See Outline Table

### $\Delta R_{thJ-hs}$ Conduction

(The following table shows the increment of thermal resistance R<sub>thJ-hs</sub> when devices operate at different conduction angles than DC)

Conduction angle	Sinusoidal conduction		Rectangular conduction		Units	Conditions
	Single Side	Double Side	Single Side	Double Side		
180°	0.003	0.003	0.002	0.002	K/W	T <sub>J</sub> = T <sub>J</sub> max.
120°	0.004	0.004	0.004	0.004		
90°	0.005	0.005	0.005	0.005		
60°	0.007	0.007	0.007	0.007		
30°	0.012	0.012	0.012	0.012		

### Ordering Information Table

Device Code							
1	2	3	4	5	6	7	8
ST	120	0	C	20	K	1	
<b>1</b>	- Thyristor						
<b>2</b>	- Essential part number						
<b>3</b>	- 0 = Converter grade						
<b>4</b>	- C = Ceramic Puk						
<b>5</b>	- Voltage code: Code x 100 = V <sub>RRM</sub> (See Voltage Rating Table)						
<b>6</b>	- K = Puk Case A-24 (K-PUK)						
<b>7</b>	- 0 = Eyelet terminals (Gate and Auxiliary Cathode Unsoldered Leads) 1 = Fast-on terminals (Gate and Auxiliary Cathode Unsoldered Leads) 2 = Eyelet terminals (Gate and Auxiliary Cathode Soldered Leads) 3 = Fast-on terminals (Gate and Auxiliary Cathode Soldered Leads)						
<b>8</b>	- Critical dv/dt: None = 500V/μsec (Standard selection) L = 1000V/μsec (Special selection)						

Outline Table

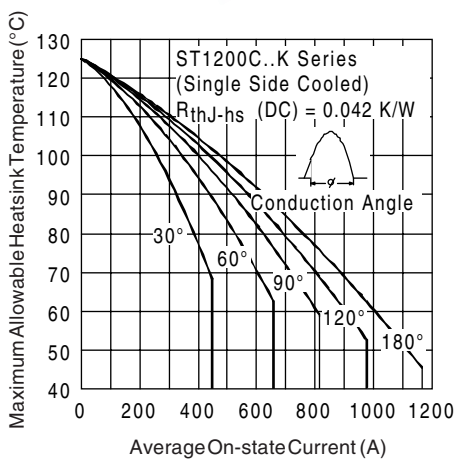
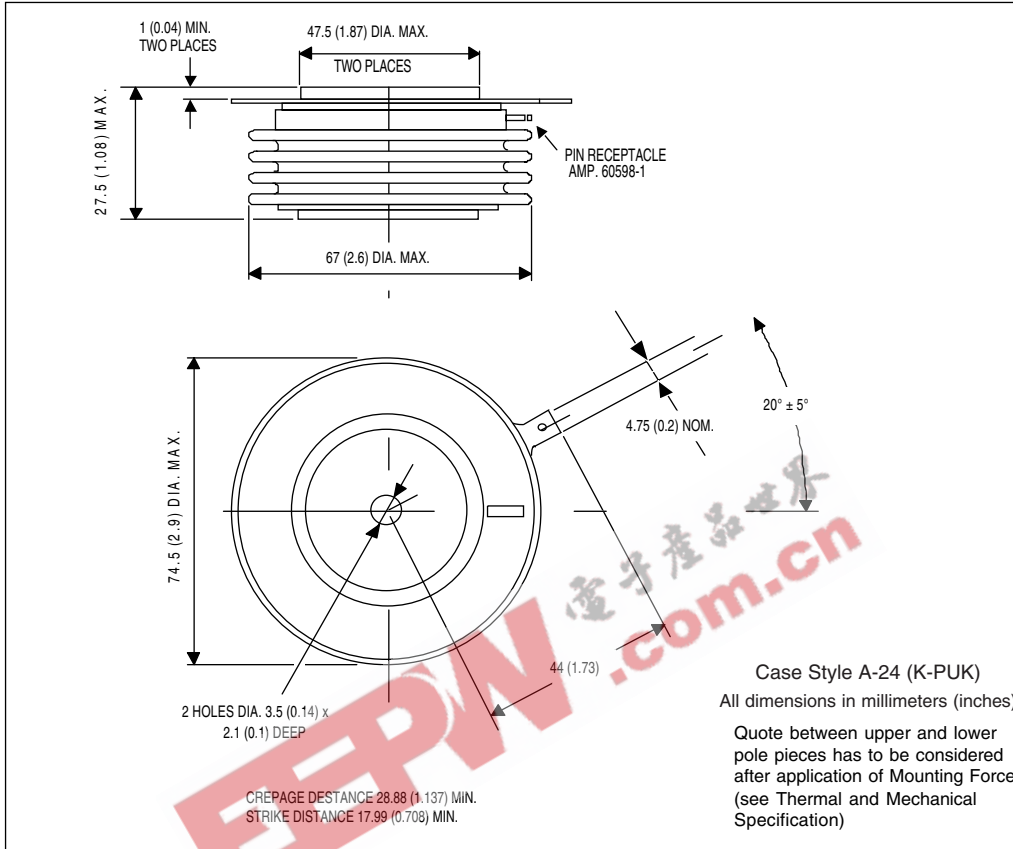

Fig. 1 - Current Ratings Characteristics

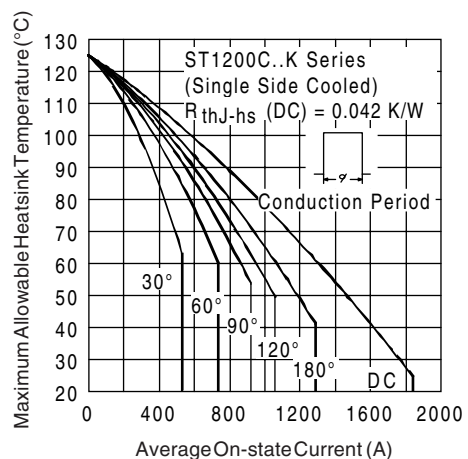

Fig. 2 - Current Ratings Characteristics

# ST1200C..K Series

Bulletin I25196 rev. B 01/00

International  
**IRF** Rectifier

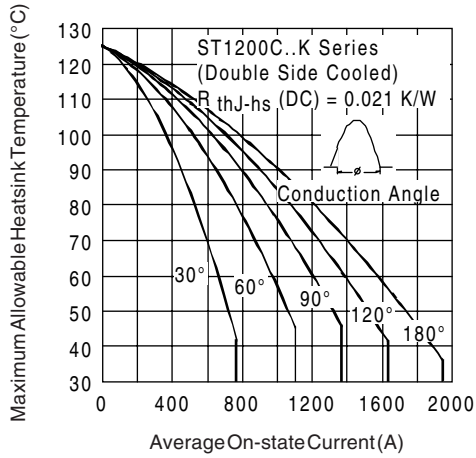

Fig. 3 - Current Ratings Characteristics

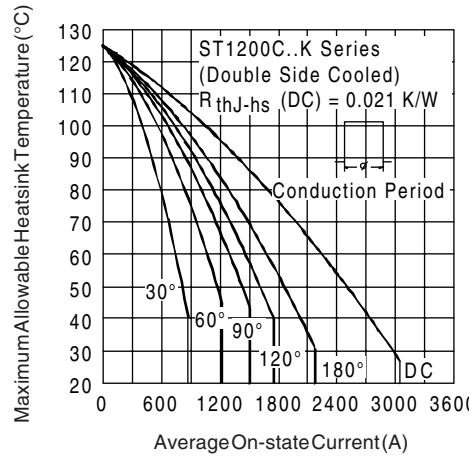

Fig. 4 - Current Ratings Characteristics

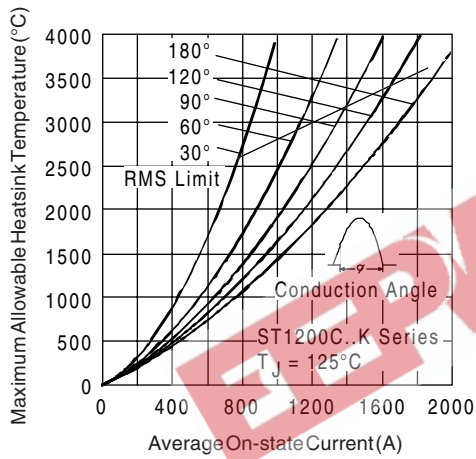

Fig. 5 - On-state Power Loss Characteristics

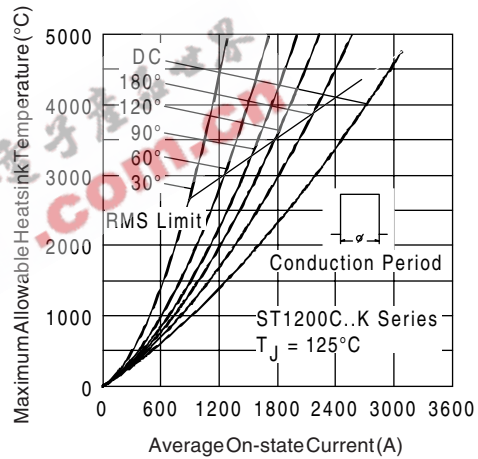

Fig. 6 - On-state Power Loss Characteristics

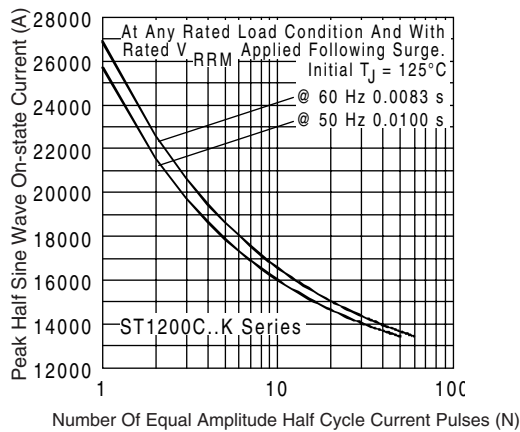

Fig. 7 - Maximum Non-Repetitive Surge Current Single and Double Side Cooled

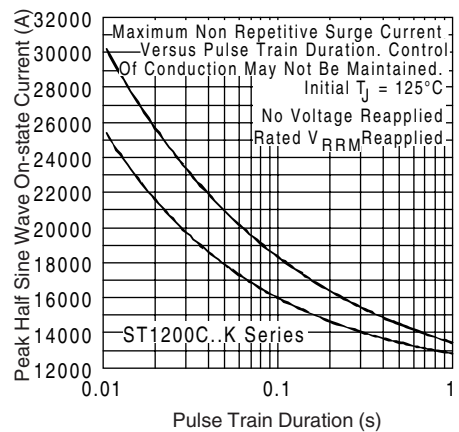

Fig. 8 - Maximum Non-Repetitive Surge Current Single and Double Side Cooled

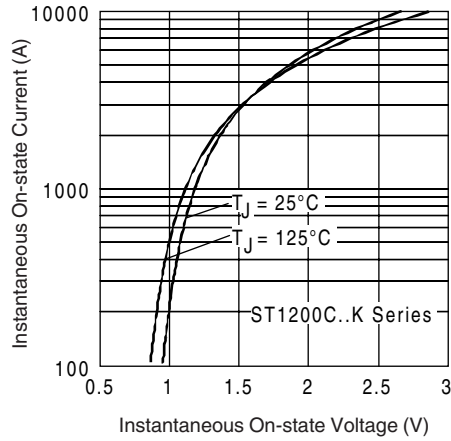

Fig. 9 - On-state Voltage Drop Characteristics

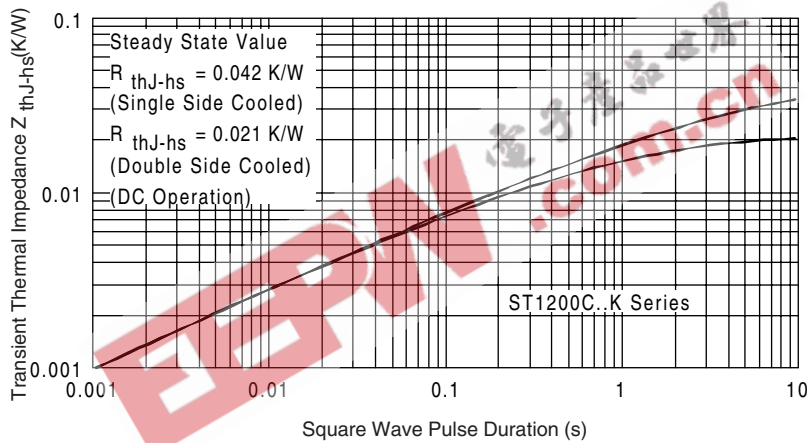

Fig. 10 - Thermal Impedance  $Z_{thJ-hs}$  Characteristics

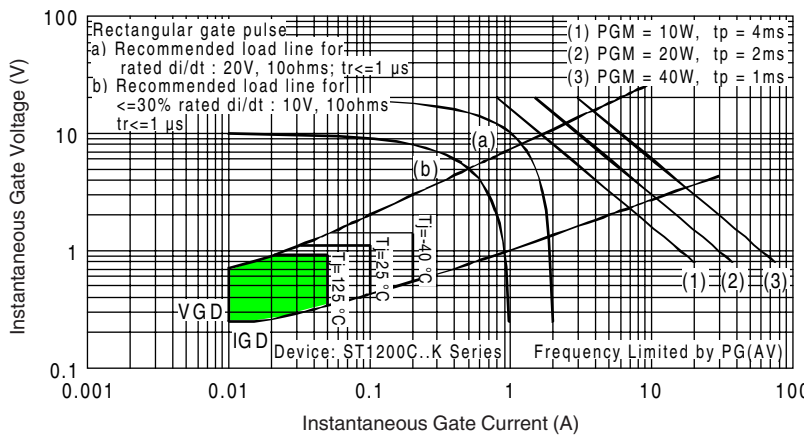

Fig. 11 - Gate Characteristics