



STK402-070

Two-Channel Class AB Audio Power Amplifier IC 40W + 40W

Overview

The STK402-000 series products are audio power amplifier hybrid ICs that consist of optimally-designed discrete component power amplifier circuits that have been miniaturized using SANYO's unique insulated metal substrate technology (IMST). SANYO has adopted a new low thermal resistance substrate in these products to reduce the package size by about 60% as compared to the earlier SANYO STK407-000 series.

Features

- Series of pin compatible power amplifiers ranging from 20 W × 2 channels to 120 W × 2 channel (10%/1 kHz) devices. The same printed circuit board can be used depending on the output power grade.
 - The pin arrangement is compatible with that of the 3-channel STK402-200 series. This means that 3-channel printed circuit boards can also be used for 2-channel products.
 - Miniature packages
 - 15 W/ch to 40 W/ch (THD = 0.4%, f = 20 Hz to 20 kHz); 46.6 mm × 25.5 mm × 8.5 mm *
 - 50 W/ch to 80 W/ch (THD = 0.4%, f = 20 Hz to 20 kHz); 59.2 mm × 31.0 mm × 8.5 mm *
- *: Not including the pins.
- Output load impedance: $R_L = 6 \Omega$
 - Allowable load shorted time: 0.3 seconds
 - Supports the use of standby, muting, and load shorting protection circuits.

Package Dimensions

unit: mm

4189-SIP15

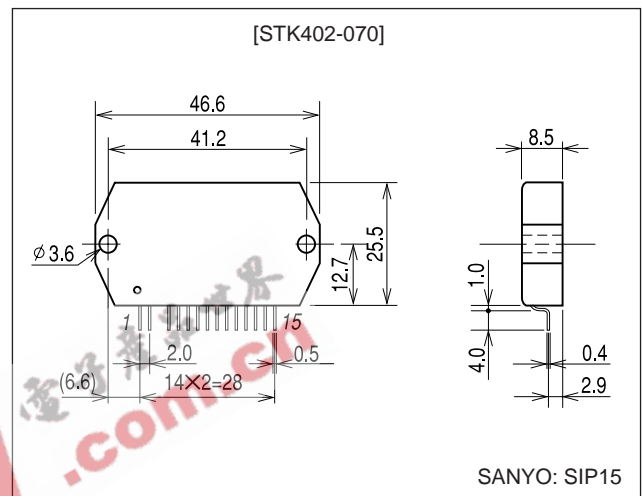

■ Any and all SANYO products described or contained herein do not have specifications that can handle applications that require extremely high levels of reliability, such as life-support systems, aircraft's control systems, or other applications whose failure can be reasonably expected to result in serious physical and/or material damage. Consult with your SANYO representative nearest you before using any SANYO products described or contained herein in such applications.

■ SANYO assumes no responsibility for equipment failures that result from using products at values that exceed, even momentarily, rated values (such as maximum ratings, operating condition ranges, or other parameters) listed in products specifications of any and all SANYO products described or contained herein.

SANYO Electric Co.,Ltd. Semiconductor Company

TOKYO OFFICE Tokyo Bldg., 1-10, 1 Chome, Ueno, Taito-ku, TOKYO, 110-8534 JAPAN

STK402-070

Series Organization

These products are organized as a series based on their output capacity.

Item	Type No.							
	STK402-020	STK402-030	STK402-040	STK402-050	STK402-070	STK402-090	STK402-100	STK402-120
Output 1 (10%/1 kHz)	20 W + 20 W	30 W + 30 W	40 W + 40 W	45 W + 45 W	60 W + 60 W	80 W + 80 W	100 W + 100 W	120 W + 120 W
Output 2 (0.4%/20 Hz to 20 kHz)	15 W + 15 W	20 W + 20 W	25 W + 25 W	30 W + 30 W	40 W + 40 W	50 W + 50 W	60 W + 60 W	80 W + 80 W
Maximum supply voltage (No signal)	±30 V	±34 V	±38 V	±40 V	±50 V	±54 V	±57 V	±65 V
Maximum supply voltage (6 Ω)	±28 V	±32 V	±36 V	±38 V	±44 V	±47 V	±50 V	±57 V
Recommended supply voltage (6 Ω)	±19 V	±22 V	±25 V	±26.5 V	±30 V	±32 V	±35 V	±39 V
Package	46.6 mm × 25.5 mm × 8.5 mm					59.2 mm × 31.0 mm × 8.5 mm		

Specifications

Maximum Ratings at $T_a = 25^\circ\text{C}$

Parameter	Symbol	Conditions	Ratings	Unit
Maximum supply voltage (No signal)	$V_{CC \max(0)}$		±50	V
Maximum supply voltage	$V_{CC \max(1)}$	$R_L = 6 \Omega$	±44	V
Thermal resistance	θ_{j-c}	Per power transistor	3.2	$^\circ\text{C/W}$
Junction temperature	$T_j \max$	Both the $T_j \max$ and the $T_c \max$ conditions must be met.	150	$^\circ\text{C}$
Operating IC substrate temperature	$T_c \max$		125	$^\circ\text{C}$
Storage temperature	T_{stg}		-30 to +125	$^\circ\text{C}$
Allowable load shorted time	t_s	$V_{CC} = \pm 30.0 \text{ V}$, $R_L = 6 \Omega$, $f = 50 \text{ Hz}$, $P_O = 40 \text{ W}$	0.3	s

Operating Characteristics at $T_a = 25^\circ\text{C}$, $R_L = 6 \Omega$ (noninductive load), $R_g = 600 \Omega$, $V_G = 30 \text{ dB}$

Parameter	Symbol	Conditions*1				Ratings			Unit	
		V_{CC} (V)	f (Hz)	P_O (W)	THD (%)	min	typ	max		
Output power (continuous output)	$P_O(1)$	±30.0	20 to 20 k		0.4	38	40		W	
	$P_O(2)$	±30.0	1 k		10		60			
Total harmonic distortion	THD (1)	±30.0	20 to 20 k	1.0				0.4	%	
	THD (2)	±30.0	1 k	5.0			0.01			
Frequency characteristics	f_L, f_H	±30.0		1.0		+0 -3 dB	20 to 50 k		Hz	
Input impedance	r_i	±30.0	1 k	1.0			55		k Ω	
Output noise voltage *2	V_{NO}	±36.0				$R_g = 2.2 \text{ k}\Omega$		1.2	mVrms	
Quiescent current	I_{CCO}	±36.0					10	40	80	mA
Neutral voltage	V_N	±36.0					-70	0	+70	mV

Notes: 1. Unless otherwise noted, use a constant-voltage supply for the power supply used during inspection.

2. The output noise voltage values shown are peak values read with a VTVM. However, an AC stabilized (50 Hz) power supply should be used to minimize the influence of AC primary side flicker noise on the reading.

Use the transformer power supply circuit stipulated in the figure below for output noise voltage measurement.

3. Use the transformer power supply circuit stipulated in the figure below for allowable load shorted time measurement.

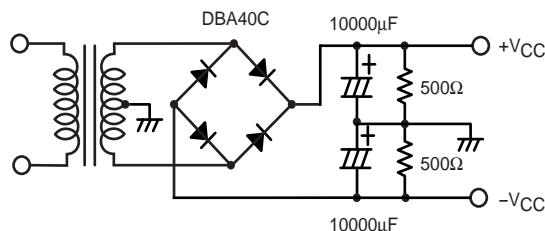

Stipulated Transformer Power Supply (MG-200 equivalent)

Thermal Design Example

The thermal resistance, θ_{c-a} of the required heat sink for the power dissipation, P_d , within the hybrid IC is determined as follows.

Condition 1: The IC substrate temperature, T_c , must not exceed 125°C.

$$P_d \times \theta_{c-a} + T_a < 125^\circ\text{C} \dots\dots\dots (1)$$

T_a : Guaranteed ambient temperature for the end product.

Condition 2: The junction temperature, T_j , of each power transistor must not exceed 150°C.

$$P_d \times \theta_{c-a} + P_d/N \times \theta_{j-c} + T_a < 150^\circ\text{C} \dots\dots\dots (2)$$

N : Number of power transistors

θ_{c-a} : Thermal resistance per power transistor

However, the power dissipation, P_d , for the power transistors shall be allocated equally among the N transistors. The following inequalities results from solving equations (1) and (2) for θ_{c-a} .

$$\theta_{c-a} < (125 - T_a) / P_d \dots\dots\dots (1)'$$

$$\theta_{c-a} < (150 - T_a) / P_d - \theta_{j-c} / N \dots\dots\dots (2)'$$

Values that satisfy these two inequalities at the same time represent the required heat sink thermal resistance. When the following specifications have been stipulated, the required heat sink thermal resistance can be determined from formulas (1)' and (2)'.

- Supply voltage — V_{CC}
- Load resistance value — R_L
- Guaranteed ambient temperature — T_a

[Example]

When the IC supply voltage, V_{CC} , is $\pm 30\text{ V}$ and R_L is $6\ \Omega$, the IC internal power dissipation, P_d , will be a maximum of 63 W for a continuous sine wave signal at 1 kHz, according to the $P_d - P_O$ characteristics.

For the music signals normally handled by audio amplifiers, a value of 1/8 P_O max is generally used for P_d as an estimate of the power dissipation based on this type of continuous signal. (Note that the factor used may differ depending on the safety standards used.)

That is:

$$P_d = 42\text{ W (When } 1/8 P_O \text{ max} = 5\text{ W)}$$

The number of power transistors in the audio amplifier block of these hybrid ICs, N , is 4, and the thermal resistance per transistor is 3.2°C/W . Therefore, the required heat sink thermal resistance for a guaranteed ambient temperature of 50°C will be as follows.

$$\begin{aligned} \text{From formula (1)'} \quad \theta_{c-a} &< (125 - 50) / 42 \\ &< 1.78 \end{aligned}$$

$$\begin{aligned} \text{From formula (2)'} \quad \theta_{c-a} &< (150 - 50) / 42 - 3.2/4 \\ &< 1.58 \end{aligned}$$

Therefore, 1.58°C/W is the required heat sink thermal resistance.

Note that this thermal design example assumes the use of a constant-voltage power supply, and is therefore not a verified design for any particular user's end product.

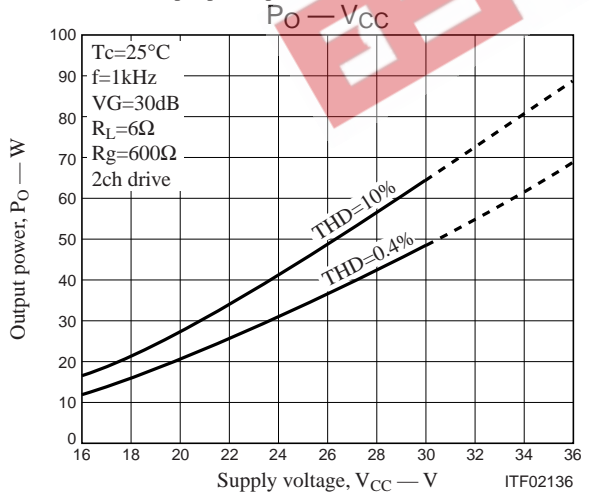
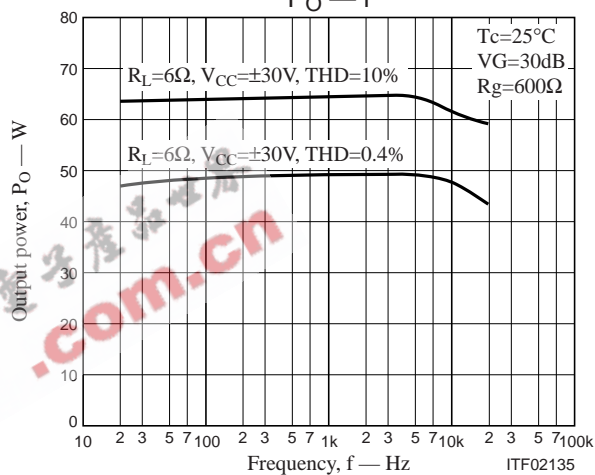
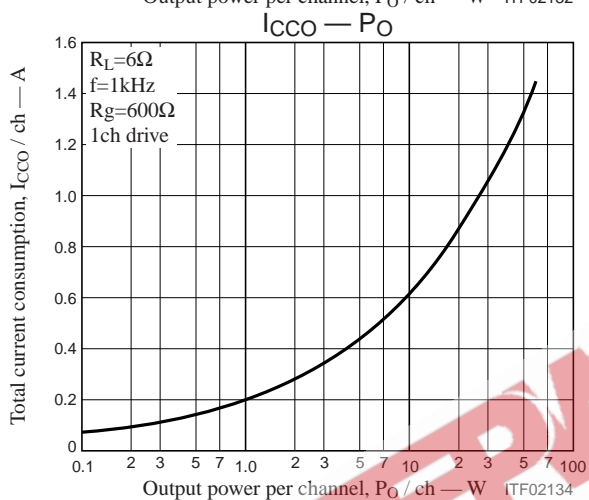
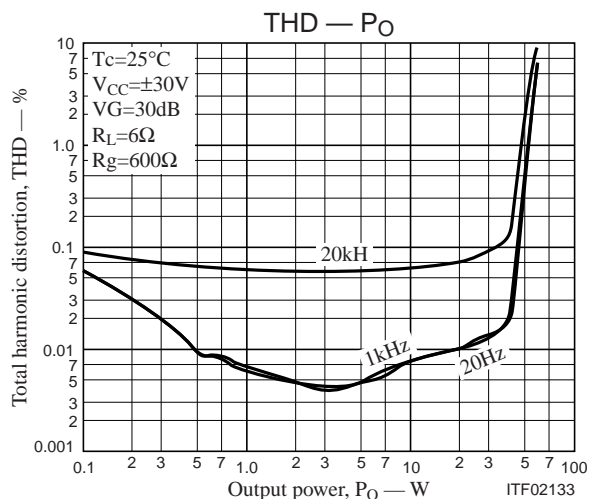
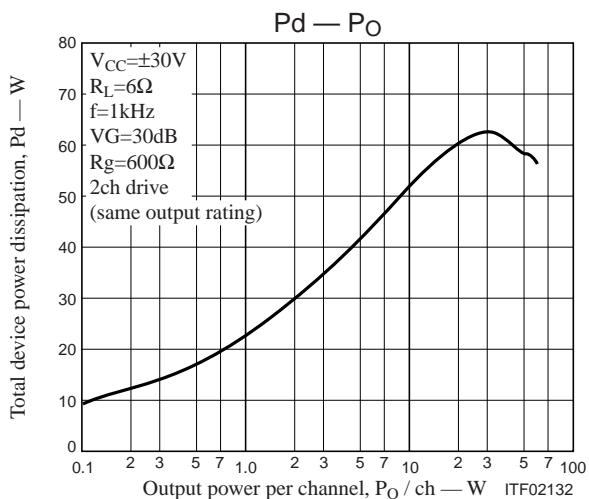

FEPW 电子產品世界 .com.cn

- Specifications of any and all SANYO products described or contained herein stipulate the performance, characteristics, and functions of the described products in the independent state, and are not guarantees of the performance, characteristics, and functions of the described products as mounted in the customer's products or equipment. To verify symptoms and states that cannot be evaluated in an independent device, the customer should always evaluate and test devices mounted in the customer's products or equipment.
- SANYO Electric Co., Ltd. strives to supply high-quality high-reliability products. However, any and all semiconductor products fail with some probability. It is possible that these probabilistic failures could give rise to accidents or events that could endanger human lives, that could give rise to smoke or fire, or that could cause damage to other property. When designing equipment, adopt safety measures so that these kinds of accidents or events cannot occur. Such measures include but are not limited to protective circuits and error prevention circuits for safe design, redundant design, and structural design.
- In the event that any or all SANYO products (including technical data, services) described or contained herein are controlled under any of applicable local export control laws and regulations, such products must not be exported without obtaining the export license from the authorities concerned in accordance with the above law.
- No part of this publication may be reproduced or transmitted in any form or by any means, electronic or mechanical, including photocopying and recording, or any information storage or retrieval system, or otherwise, without the prior written permission of SANYO Electric Co., Ltd.
- Any and all information described or contained herein are subject to change without notice due to product/technology improvement, etc. When designing equipment, refer to the "Delivery Specification" for the SANYO product that you intend to use.
- Information (including circuit diagrams and circuit parameters) herein is for example only; it is not guaranteed for volume production. SANYO believes information herein is accurate and reliable, but no guarantees are made or implied regarding its use or any infringements of intellectual property rights or other rights of third parties.

This catalog provides information as of September, 2001. Specifications and information herein are subject to change without notice.