

POWER SCHOTTKY RECTIFIER

MAIN PRODUCT CHARACTERISTICS

$I_{F(AV)}$	3 A
V_{RRM}	60 V
$T_j(max)$	150°C
$V_F(max)$	0.61 V

FEATURES AND BENEFITS

- NEGLIGIBLE SWITCHING LOSSES
- LOW THERMAL RESISTANCE
- AVALANCHE CAPABILITY SPECIFIED

DESCRIPTION

Axial and Surface Mount Power Schottky rectifier suited for Switch Mode Power Supplies and high frequency DC to DC converters. Packaged in DO-201AD, DO-15 and SMB, this device is intended for use in low voltage, high frequency inverters and small battery chargers.

For applications where there are space constraints, e.g Telecom battery charger.



ABSOLUTE RATINGS (limiting values)

Symbol	Parameter		Value	Unit
V_{RRM}	Repetitive peak reverse voltage		60	V
$I_{F(RMS)}$	RMS forward current		10	A
$I_{F(AV)}$	Average forward current	$T_L = 105^\circ\text{C} \delta = 0.5$ (DO-201AD, SMB)	3	A
		$T_L = 75^\circ\text{C} \delta = 0.5$ (DO-15)		
I_{FSM}	Surge non repetitive forward current	$t_p = 10 \text{ ms}$ Sinusoidal	100	A
P_{ARM}	Repetitive peak avalanche power	$t_p = 1 \mu\text{s}$ $T_j = 25^\circ\text{C}$	2000	W
T_{stg}	Storage temperature range		- 65 to + 150	°C
T_j	Maximum operating junction temperature *		150	°C
dV/dt	Critical rate of rise of reverse voltage		10000	V/ μs

* : $\frac{dP_{tot}}{dT_j} < \frac{1}{R_{th(j-a)}}$ thermal runaway condition for a diode on its own heatsink

STPS3L60/Q/U

THERMAL RESISTANCES

Symbol	Parameter		Value	Unit	
$R_{th(j-l)}$	Junction to leads	Lead length = 10 mm	DO-201AD	20	°C/W
			SMB	20	
			DO-15	35	

STATIC ELECTRICAL CHARACTERISTICS

Symbol	Parameter	Tests conditions		Min.	Typ.	Max.	Unit
I_R^*	Reverse leakage current	$T_j = 25^\circ\text{C}$	$V_R = V_{RRM}$			150	μA
		$T_j = 100^\circ\text{C}$		4	15	mA	
		$T_j = 125^\circ\text{C}$		14	30		
V_F^*	Forward voltage drop	$T_j = 25^\circ\text{C}$	$I_F = 3\text{ A}$			0.62	V
		$T_j = 100^\circ\text{C}$		0.53	0.61		
		$T_j = 125^\circ\text{C}$		0.51	0.59		
		$T_j = 25^\circ\text{C}$	$I_F = 6\text{ A}$			0.79	
		$T_j = 100^\circ\text{C}$		0.62	0.71		
		$T_j = 125^\circ\text{C}$		0.6	0.69		

Pulse test : * $t_p = 380\ \mu\text{s}$, $\delta < 2\%$

To evaluate the maximum conduction losses use the following equation:

$$P = 0.44 \times I_{F(AV)} + 0.05 \times I_F^2(RMS)$$

Fig. 1: Average forward power dissipation versus average forward current.

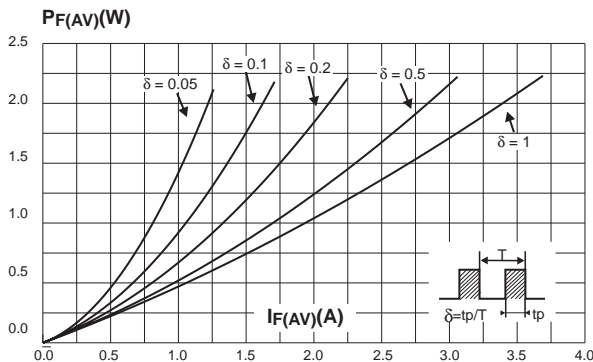

Fig. 2-1: Average forward current versus ambient temperature ($\delta = 0.5$) (DO-201AD, SMB).

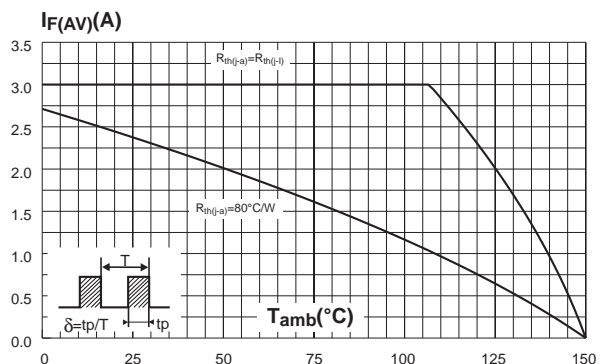

Fig. 2-2: Average forward current versus ambient temperature ($\delta = 0.5$) (DO-15).

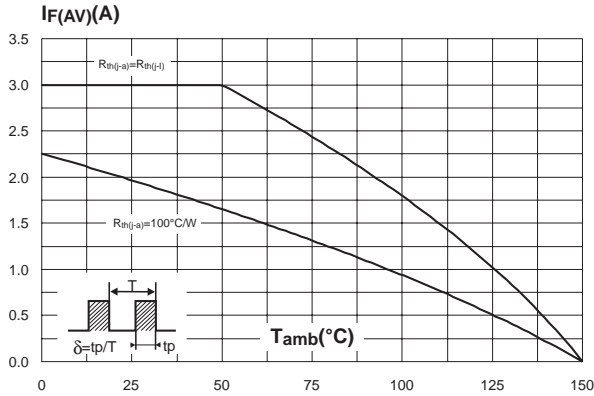

Fig. 3: Normalized avalanche power derating versus pulse duration.

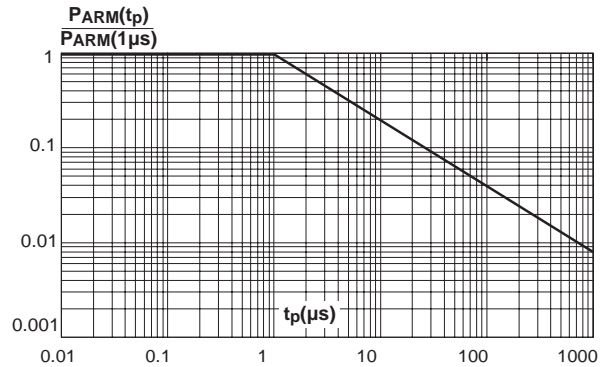

Fig. 4: Normalized avalanche power derating versus junction temperature.

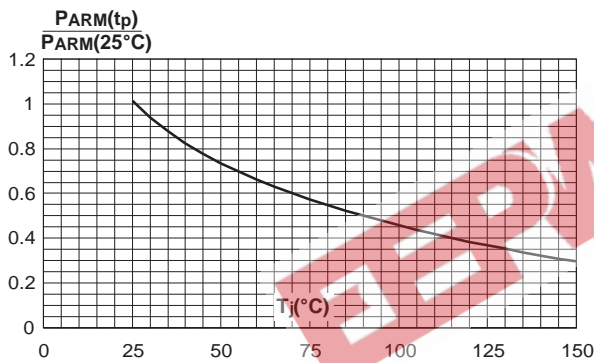

Fig. 5-1: Non repetitive surge peak forward current versus overload duration (maximum values) (DO-201AD, SMB).

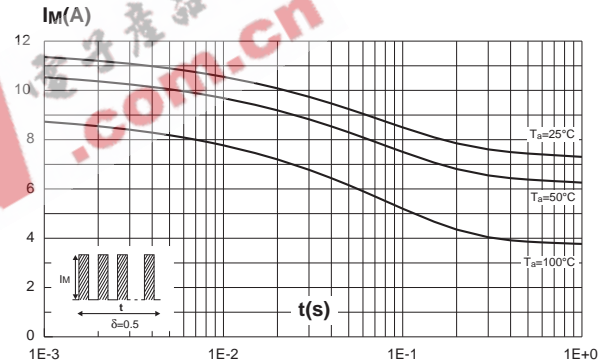

Fig. 5-2: Non repetitive surge peak forward current versus overload duration (maximum values) (DO-15).

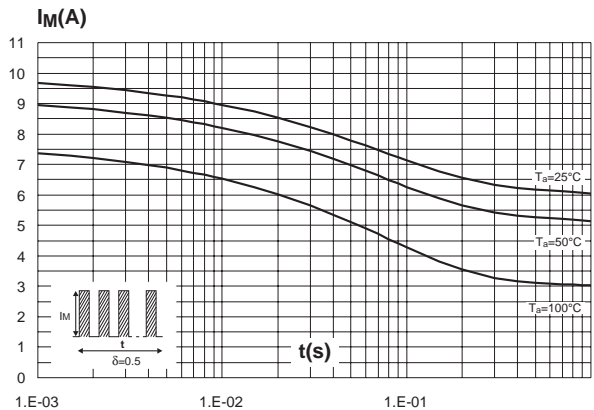

Fig. 6-1: Relative variation of thermal impedance junction to ambient versus pulse duration (DO-201AD, SMB).

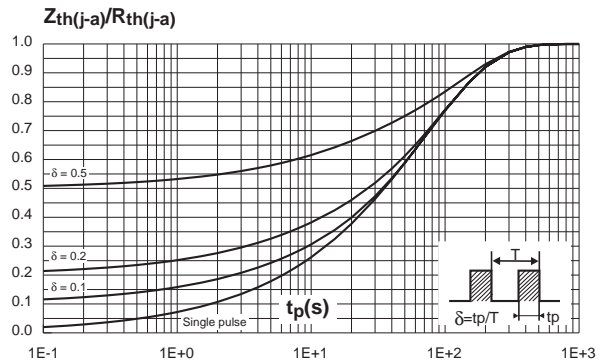

Fig. 6-2: Relative variation of thermal impedance junction to ambient versus pulse duration (DO-15).

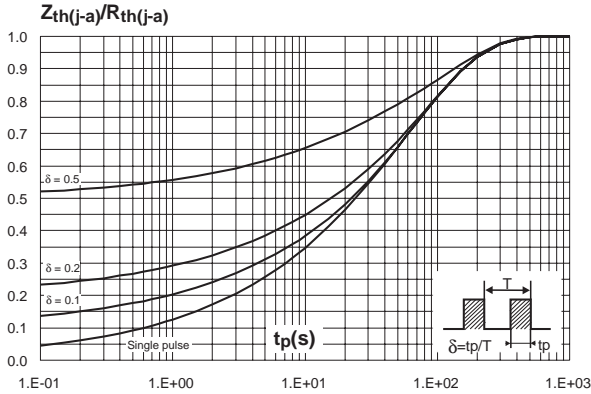

Fig. 7: Reverse leakage current versus reverse voltage applied (typical values).

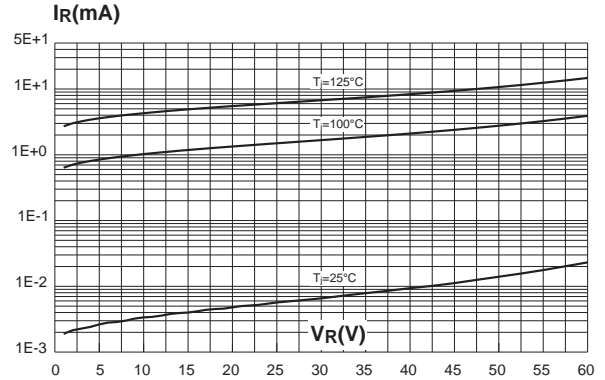

Fig. 8: Junction capacitance versus reverse voltage applied (typical values).

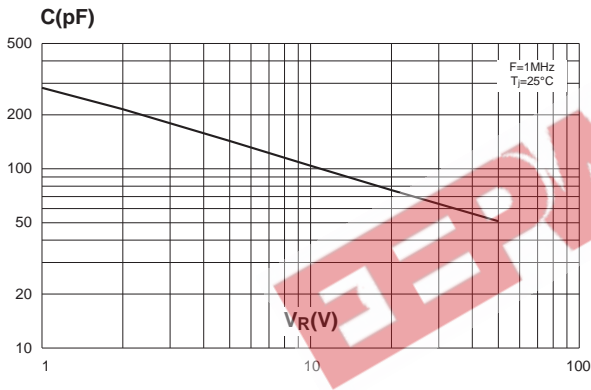

Fig. 9-1: Forward voltage drop versus forward current (high level, maximum values).

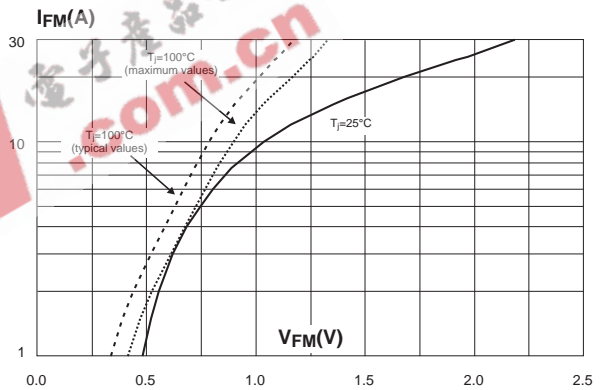

Fig. 9-2: Forward voltage drop versus forward current (low level, maximum values).

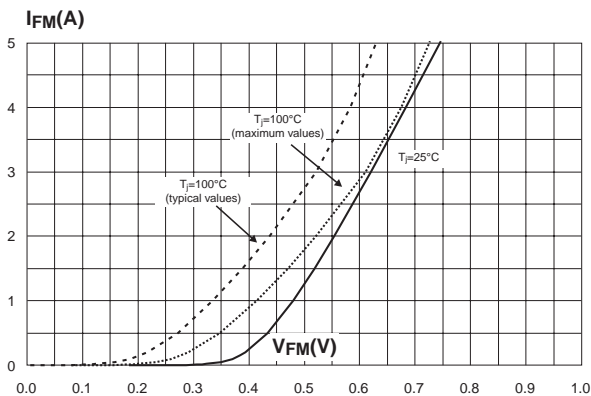
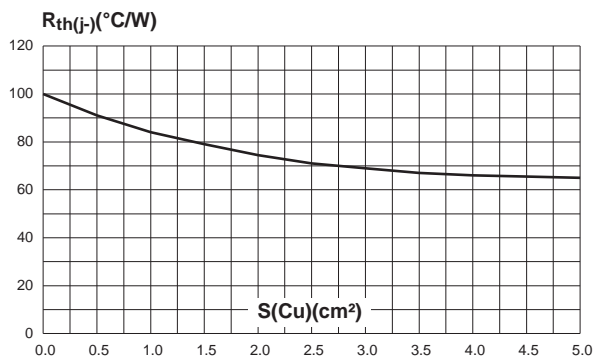
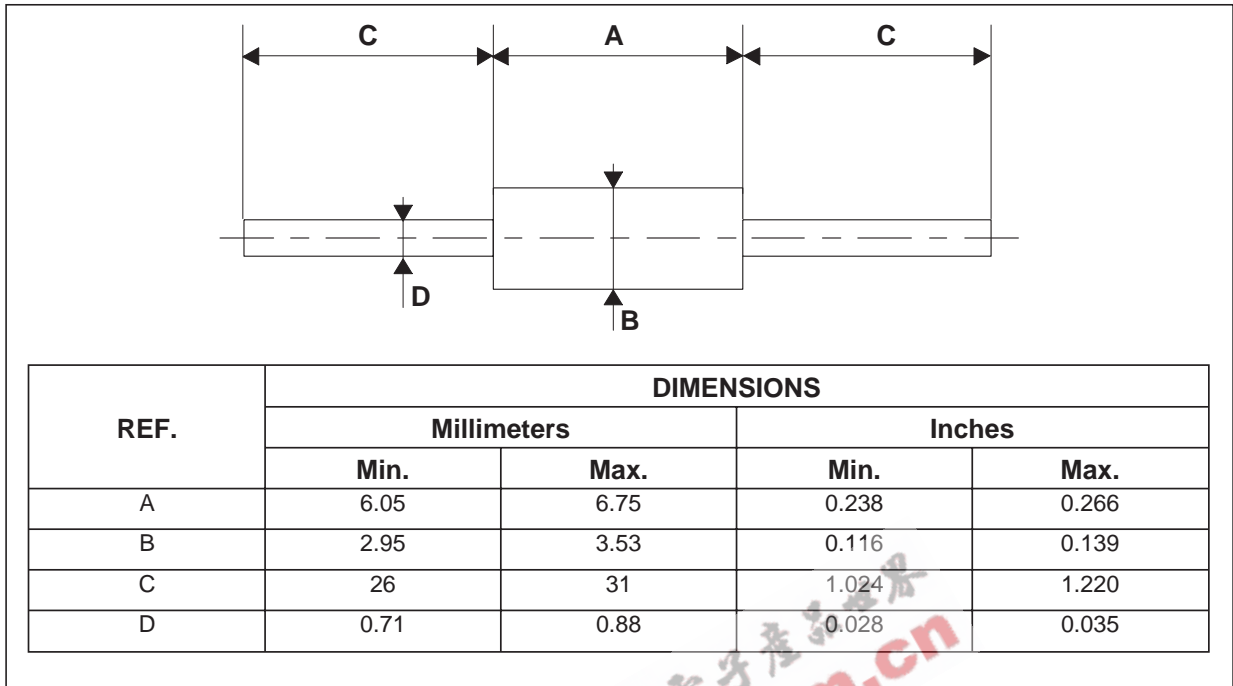

Fig. 10: Thermal resistance junction to ambient versus copper surface under each lead (Epoxy printed circuit board FR4, Cu: 35 μm) (SMB).



PACKAGE MECHANICAL DATA
DO-15 plastic



PACKAGE MECHANICAL DATA
DO-201AD plastic

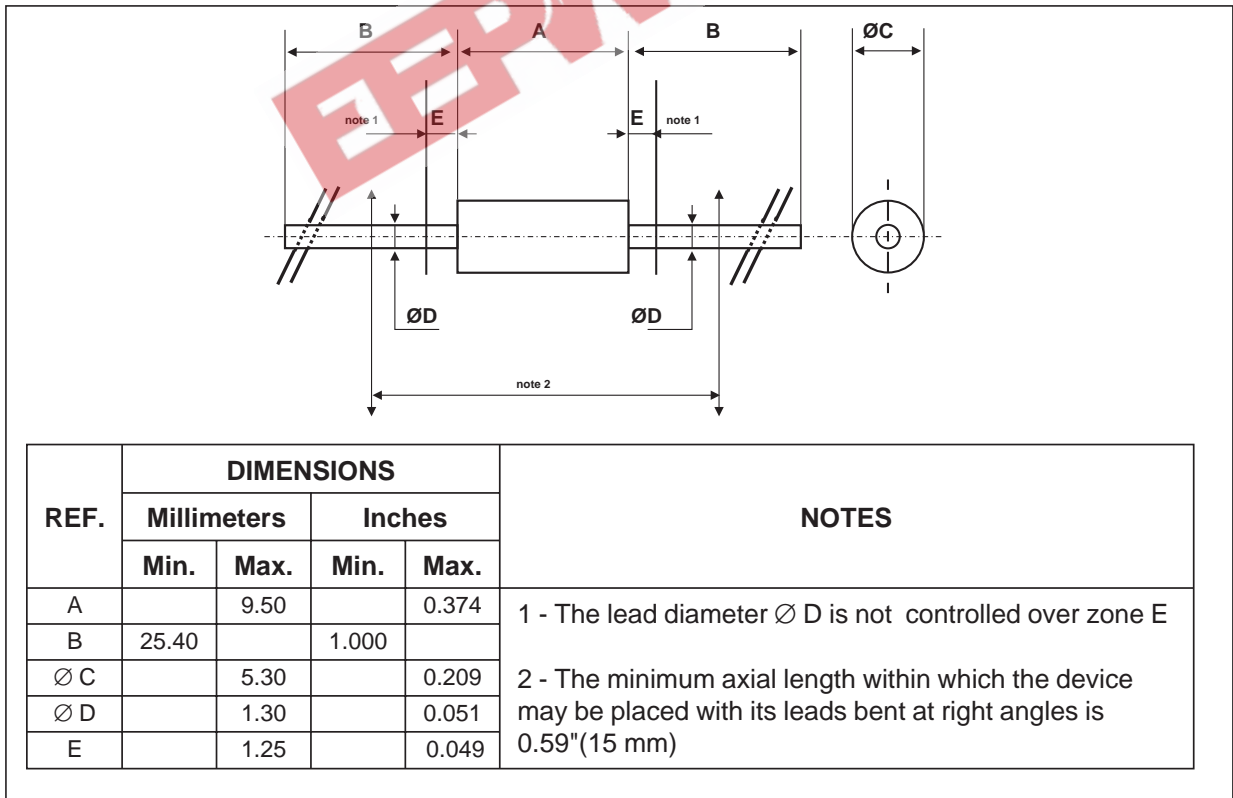

STPS3L60/Q/U

PACKAGE MECHANICAL DATA SMB (JEDEC DO-214AA)

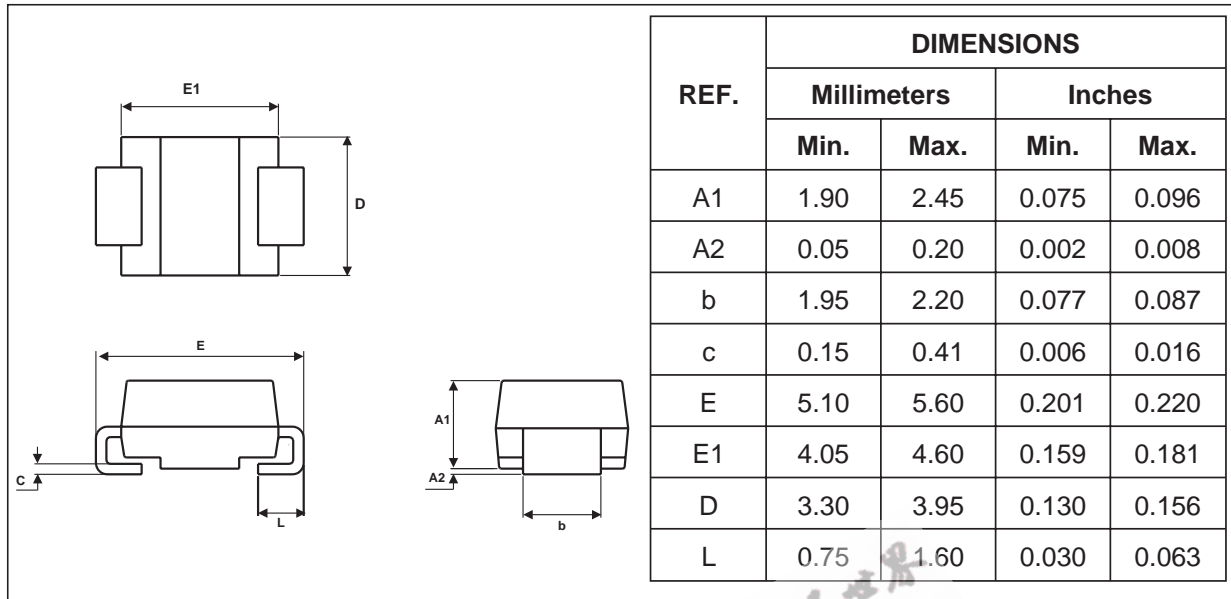

FOOT PRINT DIMENSIONS (in millimeters)

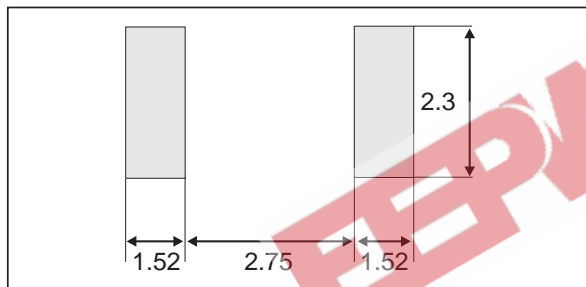

Ordering type	Marking	Package	Weight	Base qty	Delivery mode
STPS3L60	STPS3L60	DO-201AD	1.12g	600	Ammopack
STPS3L60RL	STPS3L60	DO-201AD	1.12g	1900	Tape & Reel
STPS3L60Q	STPS3L60	DO-15	0.4 g	1000	Ammopack
STPS3L60QRL	STPS3L60	DO-15	0.4 g	6000	Tape & Reel
STPS3L60U	G36	SMB	0.107 g	2500	Tape & Reel

- White band indicates cathode
- Epoxy meets UL94,V0

Information furnished is believed to be accurate and reliable. However, STMicroelectronics assumes no responsibility for the consequences of use of such information nor for any infringement of patents or other rights of third parties which may result from its use. No license is granted by implication or otherwise under any patent or patent rights of STMicroelectronics. Specifications mentioned in this publication are subject to change without notice. This publication supersedes and replaces all information previously supplied. STMicroelectronics products are not authorized for use as critical components in life support devices or systems without express written approval of STMicroelectronics.

The ST logo is a registered trademark of STMicroelectronics
 © 2003 STMicroelectronics - Printed in Italy - All rights reserved.
 STMicroelectronics GROUP OF COMPANIES
 Australia - Brazil - Canada - China - Finland - France - Germany
 Hong Kong - India - Israel - Italy - Japan - Malaysia - Malta - Morocco - Singapore
 Spain - Sweden - Switzerland - United Kingdom - United States.

<http://www.st.com>

