

KEMET

- TANTALUM
 - HERMETICALLY SEALED
 - MOLDED
 - DIPPED
- AXIAL & RADIAL CAPACITORS











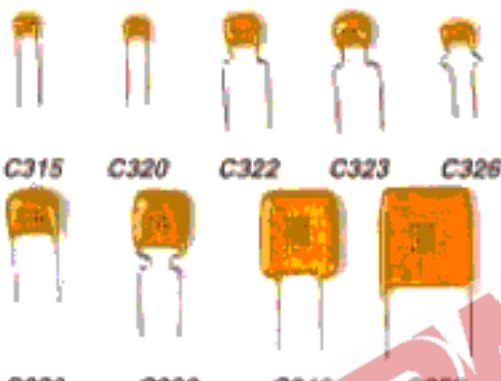

 KEMET on the INTERNET
<http://www.kemet.com>
E-Mail: capmaster@kemet.com

TANTALUM LEADED CATALOG

KEMET[®] CAPACITORS

MILITARY SPECIFICATIONS ON BACK

C E R A M I C				T A N T A L U M			
CHIPS (Surface Mounted Device) 0.5 pF-4.7 μ F *0402 *0603 *0805 *1206 *1210  *1812 *1825 2220 2225 *1632 Array *EIA Standard Style				CHIPS (Surface Mounted Device) 0.1-470 μ F T491 Industrial T492 Military T494 Low ESR Industrial T495 Low ESR Surge Robust T496 Fused T510 Ultra-Low ESR 			
CONFORMALLY COATED RADIAL Golden Max 1pF-6.8 μ F  C315 C320 C322 C323 C326 C330 C333 C340 C350				CONFORMALLY COATED RADIAL Ultradip T350 Series 0.1-680 μ F Ultradip III T396/T398 0.1-680 μ F  T350 T351 T352 T353 T354 T355 T356 T363 Series 0.1-330 μ F T363 (CX02) T368 T369 (CX12)			
CONFORMALLY COATED AXIAL Aximax 10pF-1 μ F  C410 C412 C420 C430 C440				MOLDED AXIAL 0.1-330 μ F  T322/T323 (CX01/CX05) A, B, C, D, E, F Case Sizes			
MOLDED RADIAL 1pF-1.0 μ F  C052 (CK05) (CKR05) C062 (CK06) (CKR06) C056 (CKR05) C066 (CKR06)				HERMETICALLY SEALED 0.0047-1200 μ F  T110, T140, T210 (GR500), T212 (CSR13), T216 (CSS13), T222, T240 (GR500), T242 (CSR23), T252 (CSR33), T256, T262 (CSP21) Series			
MOLDED AXIAL 1pF-3.3 μ F  C114 (CK12) (CKR11), C124 (CK13) (CKR12), C192 (CK14) (CKR14), C202 (CK15) (CKR15), C222 (CK16) (CKR16)				MOLDED RADIAL T330 Series 0.1-220 μ F T340 Series 0.1-330 μ F 		MICRON 0.68-220 μ F T370 Series T378 Series (CX06) 	

KEMET Electronics Corporation • Post Office Box 5928 • Greenville, South Carolina 29606 • (864)963-6300
 THESE PARTS ARE NON-WORKING MECHANICAL SAMPLES FOR SIZE REFERENCE ONLY

Parts shown are actual size

KEMET also manufactures Ceramic Leaded, and Surface Mount Capacitors - Tantalum and Ceramic. Refer to Catalog F-3101 — Ceramic Leaded, and F-3102 — Surface Mount Capacitors for detailed information on these products. GR500 Tantalum High Reliability Capacitors are also available. Refer to Catalog F-2901 for information.

T111/T213 (CSR91) MIL-C-39003/4 Series		T340 Ratings and Part Number Reference
Outline Drawing	20	T370/T378 (CX06) MIL-C-49137/6 Series
Dimensions	20	Performance Characteristics
Ordering & T111 Marking Information	20	Outline Drawing
Ratings and Part Number Reference	20-23	Dimensions
T222 (CSR09) MIL-C-39003/2 Series		Marking Information
Outline Drawing	24	Ordering Information
Dimensions	24	Ratings and Part Number Reference
Ordering & Military Marking Information	24	Tantalum Dipped Radial Capacitors
Ratings and Part Number Reference	25-26	Performance Characteristics
T140/T242 (CSR23) MIL-C-39003/3 Series		T35X Series
Outline Drawing	27	Outline Drawing
Dimensions	27	Dimensions
T140 Marking Information	27	Lead Configuration
Ratings and Part Number Reference	27-30	Ordering Information
T252 (CSR33) MIL-C-39003/6 Series		Marking Information
Outline Drawing	31	Ratings and Part Number Reference
Dimensions	31	T363 (CX02) & T369 (CX12) MIL-C-39003/12 Series
Ordering Information	31	Outline Drawing
Ratings and Part Number Reference	32-33	Dimensions
T262 (CSR21) MIL-C-39003/9 Series		Marking Information
Outline Drawing	34	Ordering Information
Dimensions	34	Ratings and Part Number Reference
Ordering Information	34	T368 Series
Ratings and Part Number Reference	35-36	Outline Drawing
T216 (CSS13) & T256 (CSS33) MIL-C-39003/10 Series		Dimensions
Outline Drawing	37	Ratings and Part Number Reference
Dimensions	37	T396 & T398 Series
Ordering Information	37	Outline Drawing
Military Ordering Information	38	Dimensions
Marking Information	38	Ordering Information
Ratings and Part Number Reference	38-41	Ratings and Part Number Reference
Tantalum Molded Axial/Radial Capacitors		Tantalum Axial Tape & Reel Packaging
T322/T323 (CX01 & CX05) MIL-C-49137/1 & 5 Series— Axial		Tantalum Radial Tape & Reel Packaging
Performance Characteristics	42	Tantalum Leaded Packaging Quantities
Outline Drawing	43	Application Notes for Solid Tantalum Capacitors
Dimensions	43	
Ordering Information	43	
Ratings and Part Number Reference	44-48	

IMPORTANT NOTICE

KEMET Electronics Corporation disclaims all warranties, whether express, implied, or statutory, in any manner whatsoever, including the condition of the equipment, its compatibility with specific equipment, its merchantability, or fitness for any particular purpose which extend beyond the description of the product.

Furthermore, under no circumstances shall KEMET Electronics Corporation be liable for any special, incidental or indirect damages resulting from the use or handling of this product.

Finally, KEMET Electronics Corporation does not assume any responsibility for the correctness of the information contained in this catalog. All design characteristics, specifications, tolerances, and dimensions are subject to change without notice.

23 — Extended Range — T242
 33 — Extended Range, Low Leakage — T252
 91 — Non-Polar — T213

VOLTAGE

Symbol	VDC Working		VDC Surge	
	85°C	125°C	85°C	125°C
B	6	4	8	5
C	10	7	13	9
D	15	10	20	12
E	20	13	26	16
F	35	23	46	28
G	50	33	65	40
H	75	50	98	64
J	100	67	130	86

CAPACITANCE

Expressed in picofarads (1 picofarads). First two digits represent the value. Last digit specifies the number of zeros.

Example

565 — 5,600,000 = 5.60 μ F
 564 — 560,000 = .56 μ F

* This Military Part Numbering System is obsolete. The correct current designation number is the MIL Specification Number, followed by the Sheet Number and Dash Number (i.e. MIL-C-39003/100-1). However, the part number breakdown shown here is shown for reference.

**MILITARY CAPACITOR APPROVED FAILURE RATE LEVELS AND MARKING
 MIL-C-39003 FOR CSR09 (T222 A & B CASE SIZES ONLY), CSR13 (T212),
 CSR21 (T262), CSR23 (T242) & CSR33 (T252) CAPACITORS**

KEMET APPROVED FAILURE RATE LEVELS — MIL-C-39003/H (EXCEPT CSR33)

STYLE	DESCRIPTION	KEMET SERIES	APPROVED FAILURE RATE LEVEL
CSR09	Polar-Subminiature	T222	S (0.001%/k hrs.)
CSR13	Polar-Standard MIL Range	T212	S (0.001%/k hrs.)
CSR21	Polar-Standard Low ESR MIL Range	T262	S (0.001%/k hrs.)
CSR23	Polar-Extended Range	T242	S (0.001%/k hrs.)

STYLE	DESCRIPTION	KEMET SERIES
CSR33	Polar-Extended Range Low Leakage	T252
CSR91	Non-Polar	T213

MILITARY MARKING

A CASE

39003	Military specification number
01 - K	Specification sheet number and trademark
9002J	Military dash number and "J" for JAN
+933	Polarity, date code (1st digit indicates year and the next two digits indicate the week)
XY	Lot symbol

C & D CASES

M39003	Military specification number
01 - 8222J	Specification sheet number, Military dash number, and "J" for JAN
+6.8 μ F	Positive terminal identifier and capacitance value
10% 50V	Capacitance tolerance and voltage
31433	Source code
9933 XY K	Date code, lot code, and trademark

B CASE

M39003	Military specification number
01 -	Specification sheet number
8006J	Military dash number and "J" for JAN
31433	Source code
+933 XY	Polarity, date code (1st digit indicates year and the next two digits indicate the week), lot symbol

**CSR91 (T213) CAPACITORS
 A, B, C & D CASES**

M39003	Military specification number
04 - 0980J	Specification sheet number, Military dash number, and "J" for JAN
1 μ F	Capacitance value
10% 20VNP	Capacitance tolerance and voltage
9933 XY 31433	Date code, lot code, and trademark

(See page 38 for CSS Marking)

PERFORMANCE CHARACTERISTICS

- **CAPACITANCE/VOLTAGE RANGE:** .0023-1200 μ F, 6-125 Volts.
- **CAPACITANCE TOLERANCE:** Available in standard EIA values with $\pm 20\%$, $\pm 10\%$ and $\pm 5\%$ tolerances.
- **DISSIPATION FACTOR:** Maximum DF limits are shown in corresponding series part number listings on pages 7-41. See Application Notes Section, page 76 for additional description.
- **DC LEAKAGE CURRENT:** Each corresponding part number table lists maximum leakage current for each capacitor on pages 7-41. See Application Notes Section, page 76 for additional description.
- **RATED VOLTAGE; WORKING VOLTAGE; SURGE VOLTAGE; REVERSE VOLTAGE:** See Application Notes Section, Pages 76 & 77 for description.
- **IMPEDANCE and ESR:** See Application Notes Section, pages 77 & 78 for description. Reference ESR values are shown for commercial hermetically sealed capacitors on page 19.

- **AC RIPPLE VOLTAGE:** Permissible ripple voltage is related to the ESR of the capacitor and power dissipation capabilities of the capacitor case size. Thermal capacities for the capacitor have been determined empirically and are listed below. For additional description see Application Notes Section, page 76.

Standard Case Size	Wattage
A	.05
B	.1
C	.15
D	.2

Maximum Power Dissipation

- **ENVIRONMENTAL CONSIDERATIONS:**
 - A. Shock Test: MIL-STD-202.
 - B. Thermal Shock, MIL-STD-202 Method 107, Condition B.
 - C. Moisture Resistance: MIL-STD-202 Method 106.
 - D. Solderability: MIL-STD-202 Method 208.

For additional Environmental Test Information see Application Notes Section, pages 80, 81 and 82.

- **LEAD MATERIAL:** Standard leaded nickel per MIL-STD-1276.
- **INSULATING SLEEVES:** The material used in transparent plastic, having 2000 volt dielectric strength, excellent dimensional stability and low moisture flow resistance.
- **LEAD TAPE and REEL:** Reel packaging per MIL-STD-883C RS-296. See pages 71 and 72 for additional information.

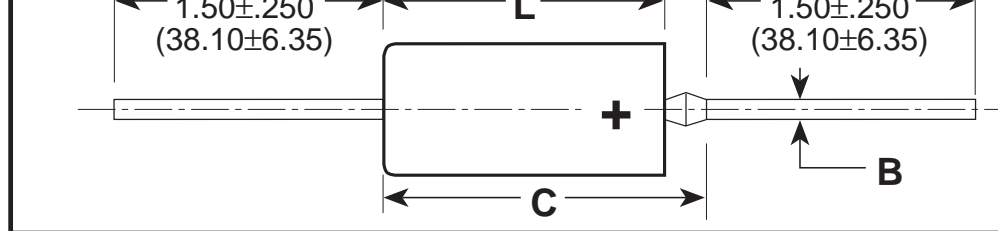

DIMENSIONS — INCHES & (MILLIMETERS)

CASE SIZE	UNINSULATED		INSULATED		B ±0.002 (.05)	
	D ±0.005 (.13)	L ±0.031 (.79)	D ±0.010 (.25)	L ±0.031 (.79)		
A	0.125 (3.18)	0.250 (6.35)	0.135 (3.43)	0.286 (7.26)	0.020 (.51)	0 (1)
B	0.175 (4.45)	0.438 (11.13)	0.185 (4.70)	0.474 (12.04)	0.020 (.51)	0 (1)
C	0.279 (7.09)	0.650 (16.51)	0.289 (7.34)	0.686 (17.42)	0.025 (.64)	0 (2)
D	0.341 (8.66)	0.750 (19.05)	0.351 (8.92)	0.786 (19.96)	0.025 (.64)	0 (2)

ORDERING INFORMATION*

T XXX A 105 K 050 A S C

TANTALUM — T

SERIES — XXX
T110, T212 (CSR13)
T111, T213 (CSR91)
T140, T242 (CSR23)

CASE SIZE — A
A / B / C / D

PICOFARAD CODE — A
First two digits represent significant figures.
Third digit specifies number of zeros to follow.

CAPACITANCE TOLERANCE — K
M — ±20% K — ±10% J — ±5%

VOLTAGE — 050
At 85°C

LEAD MATERIAL — S
S — Standard

FAILURE RATE GRADED — C
A — Not Applicable
B — 0.1%/k hrs.
C — 0.01%/k hrs.
D — 0.001%/k hrs.
**Failure Rates apply

****Part Number Example: T110A105K050AS (14 digits - no spaces)**
***For Military Ordering Information, see page 4.**

MARKING INFORMATION

Marking: Unless otherwise specified by special order, standard marking of T110 Series capacitor consists of the following:

A, B, C & D CASES

+K 10%	— Polarity, Manufacturer's Identification and Capacitance Tol.
R56 μF	— Normal Capacitance — (μF) ("R" indicates decimal)
100V	— Voltage
9912XY	— Date Code (e.g.: 9912XY)

* For Military Marking, see page 4.

3.9	A	5,10,20	T110A395(1)006AS	0.3	4													
4.7	A	5,10,20	T110A475(1)006AS	0.3	4													
5.6	A	5	T110A565J006AS	0.3	4	5001	5201	5401	5601	6001	7001	8001						
5.6	A	10	T110A565K006AS	0.3	4	2241	2481	2721	2961	6002	7002	8002						
5.6	A	20	T110A565M006AS	0.3	4													
6.8	A	5	T110A685J006AS	0.3	6	5002	5202	5402	5602	6003	7003	8003						
6.8	A	10	T110A685K006AS	0.3	6	2242	2482	2722	2962	6004	7004	8004						
6.8	A	20	T110A685M006AS	0.3	6	2243	2483	2723	2963	6005	7005	8005						
8.2	B	5,10,20	T110B825(1)006AS	0.3	6													
10.0	B	5,10,20	T110B106(1)006AS	0.3	6													
12.0	B	5,10,20	T110B126(1)006AS	0.5	6													
15.0	B	5,10,20	T110B156(1)006AS	0.9	6													
18.0	B	5,10,20	T110B186(1)006AS	0.9	6													
22.0	B	5,10,20	T110B226(1)006AS	0.9	6													
27.0	B	5,10,20	T110B276(1)006AS	0.9	6													
33.0	B	5,10,20	T110B336(1)006AS	0.9	6													
39.0	B	5,10,20	T110B396(1)006AS	0.9	6													
47.0	B	5	T110B476J006AS	1.5	6	5003	5203	5403	5603	6006	7006	8006						
47.0	B	10	T110B476K006AS	1.5	6	2244	2484	2724	2964	6007	7007	8007						
47.0	B	20	T110B476M006AS	1.5	6	2245	2485	2725	2965	6008	7008	8008						
56.0	B	5	T110B566J006AS	1.5	6	5004	5204	5404	5604	6009	7009	8009						
56.0	B	10	T110B566K006AS	1.5	6	2246	2486	2726	2966	6010	7010	8010						
56.0	B	20	T110B566M006AS	1.5	6													
68.0	C	5,10,20	T110C686(1)006AS	3.0	6													
82.0	C	5,10,20	T110C826(1)006AS	3.0	6													
100.0	C	5,10,20	T110C107(1)006AS	3.0	6													
120.0	C	5,10,20	T110C127(1)006AS	3.0	6													
150.0	C	5	T110C157J006AS	4.5	6	5005	5205	5405	5605	6011	7011	8011						
150.0	C	10	T110C157K006AS	4.5	6	2247	2487	2727	2967	6012	7012	8012						
150.0	C	20	T110C157M006AS	4.5	6	2248	2488	2728	2968	6013	7013	8013						
180.0	C	5	T110C187J006AS	5.5	6	5006	5206	5406	5606	6014	7014	8014						
180.0	C	10	T110C187K006AS	5.5	6	2249	2489	2729	2969	6015	7015	8015						
180.0	C	20	T110C187M006AS	5.5	6													
220.0	D	5,10,20	T110D227(1)006AS	6.0	8													
270.0	D	5	T110D277J006AS	6.0	8	5007	5207	5407	5607	6016	7016	8016						
270.0	D	10	T110D277K006AS	6.0	8	2250	2490	2730	2970	6017	7017	8017						
270.0	D	20	T110D277M006AS	6.0	8													
330.0	D	5	T110D337J006AS	7.5	8	5008	5208	5408	5608	6018	7018	8018						
330.0	D	10	T110D337K006AS	7.5	8	2251	2491	2731	2971	6019	7019	8019						
330.0	D	20	T110D337M006AS	7.5	8	2252	2492	2732	2972	6020	7020	8020						

10 VOLT RATING AT 85°C — 7 VOLT RATING AT 125°C

1.0	A	5,10,20	T110A105(1)010AS	0.3	3												
1.2	A	5,10,20	T110A125(1)010AS	0.3	4												
1.5	A	5,10,20	T110A155(1)010AS	0.3	4												
1.8	A	5,10,20	T110A185(1)010AS	0.3	4												
2.2	A	5,10,20	T110A225(1)010AS	0.3	4												
2.7	A	5,10,20	T110A275(1)010AS	0.3	4												
3.3	A	5,10,20	T110A335(1)010AS	0.3	4												
3.9	A	5	T110A395J 010AS	0.3	4	5009	5209	5409	5609	6021	7021	8021					
3.9	A	10	T110A395K 010AS	0.3	4	2253	2493	2733	2973	6022	7022	8022					
3.9	A	20	T110A395M 010AS	0.3	4												
4.7	A	5	T110A475J 010AS	0.4	4	5010	5210	5410	5610	6023	7023	8023					
4.7	A	10	T110A475K 010AS	0.4	4	2254	2494	2734	2974	6024	7024	8024					
4.7	A	20	T110A475M010AS	0.4	4	2255	2495	2735	2975	6025	7025	8025					

(1) To complete T110 Series Part Number, insert Capacitance Tolerance Symbol in the 9th Character as shown on Page 6.

(2) To complete the T212 Series Part Number, insert Failure Rate Symbol in the 13th Character.

Bold Face lines indicate popular part types and values.

10.0	B	5,10,20	T110B106(1)010AS	1.0	6								
12.0	B	5,10,20	T110B126(1)010AS	1.0	6								
15.0	B	5,10,20	T110B156(1)010AS	1.0	6								
18.0	B	5,10,20	T110B186(1)010AS	1.0	6								
22.0	B	5,10,20	T110B226(1)010AS	2.0	6								
27.0	B	5	T110B276J010AS	2.0	6	5011	5211	5411	5611	6026	7026	8026	
27.0	B	10	T110B276K010AS	2.0	6	2256	2496	2736	2976	6027	7027	8027	
27.0	B	20	T110B276M010AS	2.0	6								
33.0	B	5	T110B336J010AS	2.0	6	5012	5212	5412	5612	6028	7028	8028	
33.0	B	10	T110B336K010AS	2.0	6	2257	2497	2737	2977	6029	7029	8029	
33.0	B	20	T110B336M010AS	2.0	6	2258	2498	2738	2978	6030	7030	8030	
39.0	B	5	T110B396J010AS	2.0	6	5013	5213	5413	5613	6031	7031	8031	
39.0	B	10	T110B396K010AS	2.0	6	2259	2499	2739	2979	6032	7032	8032	
39.0	B	20	T110B396M010AS	2.0	6								
47.0	C	5,10,20	T110C476(1)010AS	3.0	6								
56.0	C	5,10,20	T110C566(1)010AS	3.0	6								
68.0	C	5,10,20	T110C686(1)010AS	3.0	6								
82.0	C	5	T110C826J010AS	3.0	6	5014	5214	5414	5614	6033	7033	8033	
82.0	C	10	T110C826K010AS	3.0	6	2260	2500	2740	2980	6034	7034	8034	
82.0	C	20	T110C826M010AS	3.0	6								
100.0	C	5	T110C107J010AS	5.0	6	5015	5215	5415	5615	6035	7035	8035	
100.0	C	10	T110C107K010AS	5.0	6	2261	2501	2741	2981	6036	7036	8036	
100.0	C	20	T110C107M010AS	5.0	6	2262	2502	2742	2982	6037	7037	8037	
120.0	C	5	T110C127J010AS	6.0	6	5016	5216	5416	5616	6038	7038	8038	
120.0	C	10	T110C127K010AS	6.0	6	2263	2503	2743	2983	6039	7039	8039	
120.0	C	20	T110C127M010AS	6.0	6								
150.0	D	5,10,20	T110D157(1)010AS	9.0	6								
180.0	D	5	T110D187J010AS	9.0	6	5017	5217	5417	5617	6040	7040	8040	
180.0	D	10	T110D187K010AS	9.0	6	2264	2504	2744	2984	6041	7041	8041	
180.0	D	20	T110D187M010AS	9.0	6								
220.0	D	5	T110D227J010AS	10.0	8	5018	5218	5418	5618	6042	7042	8042	
220.0	D	10	T110D227K010AS	10.0	8	2265	2505	2745	2985	6043	7043	8043	
220.0	D	20	T110D227M010AS	10.0	8	2266	2506	2746	2986	6044	7044	8044	

15 VOLT RATING AT 85°C — 10 VOLT RATING AT 125°C

0.33	A	5,10,20	T110A334(1)015AS	0.3	3								
0.39	A	5,10,20	T110A394(1)015AS	0.3	3								
0.47	A	5,10,20	T110A474(1)015AS	0.3	3								
0.56	A	5,10,20	T110A564(1)015AS	0.3	3								
0.68	A	5,10,20	T110A684(1)015AS	0.3	3								
0.82	A	5,10,20	T110A824(1)015AS	0.3	3								
1.0	A	5,10,20	T110A105(1)015AS	0.3	3								
1.2	A	5,10,20	T110A125(1)015AS	0.3	4								
1.5	A	5,10,20	T110A155(1)015AS	0.3	4								
1.8	A	5,10,20	T110A185(1)015AS	0.3	4								
2.2	A	5,10,20	T110A225(1)015AS	0.3	4								
2.7	A	5	T110A275J015AS	0.3	4	5019	5219	5419	5619	6045	7045	8045	
2.7	A	10	T110A275K015AS	0.3	4	2267	2507	2747	2987	6046	7046	8046	
2.7	A	20	T110A275M015AS	0.3	4								
3.3	A	5	T110A335J015AS	0.4	4	5020	5220	5420	5620	6047	7047	8047	
3.3	A	10	T110A335K015AS	0.4	4	2268	2508	2748	2988	6048	7048	8048	
3.3	A	20	T110A335M015AS	0.4	4	2269	2509	2749	2989	6049	7049	8049	
3.9	B	5,10,20	T110B395(1)015AS	0.4	4								
4.7	B	5,10,20	T110B475(1)015AS	0.7	4								
5.6	B	5,10,20	T110B565(1)015AS	0.7	4								

(1) To complete T110 Series Part Number, insert Capacitance Tolerance Symbol in the 9th Character as shown on Page 6.

(2) To complete the T212 Series Part Number, insert Failure Rate Symbol in the 13th Character.

Bold Face lines indicate popular part types and values.

12.0	B	5,10,20	T110B126(1)015AS	1.0	6								
15.0	B	5,10,20	T110B156(1)015AS	2.0	6								
18.0	B	5	T110B186J015AS	2.0	6	5021	5221	5421	5621	6050	7050	8050	
18.0	B	10	T110B186K015AS	2.0	6	2270	2510	2750	2990	6051	7051	8051	
18.0	B	20	T110B186M015AS	2.0	6								
22.0	B	5	T110B226J015AS	2.0	6	5022	5222	5422	5622	6052	7052	8052	
22.0	B	10	T110B226K015AS	2.0	6	2271	2511	2751	2991	6053	7053	8053	
22.0	B	20	T110B226M015AS	2.0	6	2272	2512	2752	2992	6054	7054	8054	
27.0	C	5,10,20	T110C276(1)015AS	3.0	6								
33.0	C	5,10,20	T110C336(1)015AS	3.0	6								
39.0	C	5,10,20	T110C396(1)015AS	3.0	6								
47.0	C	5,10,20	T110C476(1)015AS	4.0	6								
56.0	C	5	T110C566J015AS	4.0	6	5023	5223	5423	5623	6055	7055	8055	
56.0	C	10	T110C566K015AS	4.0	6	2273	2513	2753	2993	6056	7056	8056	
56.0	C	20	T110C566M015AS	4.0	6								
68.0	C	5	T110C686J015AS	5.0	6	5024	5224	5424	5624	6057	7057	8057	
68.0	C	10	T110C686K015AS	5.0	6	2274	2514	2754	2994	6058	7058	8058	
68.0	C	20	T110C686M015AS	5.0	6	2275	2515	2755	2995	6059	7059	8059	
82.0	D	5,10,20	T110D826(1)015AS	6.0	6								
100.0	D	5,10,20	T110D107(1)015AS	6.0	6								
120.0	D	5	T110D127J015AS	6.0	6	5025	5225	5425	5625	6060	7060	8060	
120.0	D	10	T110D127K015AS	6.0	6	2276	2516	2756	2996	6061	7061	8061	
120.0	D	20	T110D127M015AS	6.0	6								
150.0	D	5	T110D157J015AS	8.0	6	5026	5226	5426	5626	6062	7062	8062	
150.0	D	10	T110D157K015AS	8.0	6	2277	2517	2757	2997	6063	7063	8063	
150.0	D	20	T110D157M015AS	8.0	6	2278	2518	2758	2998	6064	7064	8064	
20 VOLT RATING AT 85°C — 13 VOLT RATING AT 125°C													
0.047	A	5,10,20	T110A473(1)020AS	0.1	3								
0.056	A	5,10,20	T110A563(1)020AS	0.1	3								
0.068	A	5,10,20	T110A683(1)020AS	0.1	3								
0.082	A	5,10,20	T110A823(1)020AS	0.1	3								
0.1	A	5,10,20	T110A104(1)020AS	0.3	3								
0.12	A	5,10,20	T110A124(1)020AS	0.3	3								
0.15	A	5,10,20	T110A154(1)020AS	0.3	3								
0.18	A	5,10,20	T110A184(1)020AS	0.3	3								
0.22	A	5,10,20	T110A224(1)020AS	0.3	3								
0.27	A	5,10,20	T110A274(1)020AS	0.3	3								
0.33	A	5,10,20	T110A334(1)020AS	0.3	3								
0.39	A	5,10,20	T110A394(1)020AS	0.3	3								
0.47	A	5,10,20	T110A474(1)020AS	0.3	3								
0.56	A	5,10,20	T110A564(1)020AS	0.3	3								
0.68	A	5,10,20	T110A684(1)020AS	0.3	3								
0.82	A	5,10,20	T110A824(1)020AS	0.3	3								
1.0	A	5,10,20	T110A105(1)020AS	0.3	3								
1.2	A	5	T110A125J020AS	0.3	4	5027	5227	5427	5627	6065	7065	8065	
1.2	A	10	T110A125K020AS	0.3	4	2279	2519	2759	2999	6066	7066	8066	
1.2	A	20	T110A125M020AS	0.3	4								
1.5	A	5	T110A155J020AS	0.3	4	5028	5228	5428	5628	6067	7067	8067	
1.5	A	10	T110A155K020AS	0.3	4	2280	2520	2760	3000	6068	7068	8068	
1.5	A	20	T110A155M020AS	0.3	4	2281	2521	2761	3001	6069	7069	8069	
1.8	A	5	T110A185J020AS	0.3	4	5029	5229	5429	5629	6070	7070	8070	
1.8	A	10	T110A185K020AS	0.3	4	2282	2522	2762	3002	6071	7071	8071	
1.8	A	20	T110A185M020AS	0.3	4								
2.2	A	5	T110A225J020AS	0.4	4	5010	5230	5430	5630	6072	7072	8072	
2.2	A	10	T110A225K020AS	0.4	4	2283	2523	2763	3003	6073	7073	8073	
2.2	A	20	T110A225M020AS	0.4	4	2284	2524	2764	3004	6074	7074	8074	

(1) To complete T110 Series Part Number, insert Capacitance Tolerance Symbol in the 9th Character as shown on Page 6.

(2) To complete the T212 Series Part Number, insert Failure Rate Symbol in the 13th Character.

Bold Face lines indicate popular part types and values.

4.7	B	5,10,20	T110B475(1)020AS	1.0	4												
5.6	B	5,10,20	T110B565(1)020AS	1.0	4												
6.8	B	5,10,20	T110B685(1)020AS	1.0	4												
8.2	B	5	T110B825J020AS	1.0	6	5031	5231	5431	5631	6075	7075	8075					
8.2	B	10	T110B825K020AS	1.0	6	2285	2525	2765	3005	6076	7076	8076					
8.2	B	20	T110B825M020AS	1.0	6												
10.0	B	5	T110B106J020AS	1.0	6	5032	5232	5432	5632	6077	7077	8077					
10.0	B	10	T110B106K020AS	1.0	6	2286	2526	2766	3006	6078	7078	8078					
10.0	B	20	T110B106M020AS	1.0	6	2287	2527	2767	3007	6079	7079	8079					
12.0	B	5	T110B126J020AS	1.0	6	5033	5233	5433	5633	6080	7080	8080					
12.0	B	10	T110B126K020AS	1.0	6	2288	2528	2768	3008	6081	7081	8081					
12.0	B	20	T110B126M020AS	1.0	6												
15.0	B	5	T110B156J020AS	2.0	6	5034	5234	5434	5634	6082	7082	8082					
15.0	B	10	T110B156K020AS	2.0	6	2289	2529	2769	3009	6083	7083	8083					
15.0	B	20	T110B156M020AS	2.0	6	2290	2530	2770	3010	6084	7084	8084					
18.0	C	5,10,20	T110C186(1)020AS	2.0	6												
22.0	C	5,10,20	T110C226(1)020AS	2.5	6												
27.0	C	5	T110C276J020AS	2.5	6	5035	5235	5435	5635	6085	7085	8085					
27.0	C	10	T110C276K020AS	2.5	6	2291	2531	2771	3011	6086	7086	8086					
27.0	C	20	T110C276M020AS	2.5	6												
33.0	C	5	T110C336J020AS	3.0	6	5036	5236	5436	5636	6087	7087	8087					
33.0	C	10	T110C336K020AS	3.0	6	2292	2532	2772	3012	6088	7088	8088					
33.0	C	20	T110C336M020AS	3.0	6	2293	2533	2773	3013	6089	7089	8089					
39.0	C	5	T110C396J020AS	3.0	6	5037	5237	5437	5637	6090	7090	8090					
39.0	C	10	T110C396K020AS	3.0	6	2294	2534	2774	3014	6091	7091	8091					
39.0	C	20	T110C396M020AS	3.0	6												
47.0	C	5	T110C476J020AS	4.5	6	5038	5238	5438	5638	6092	7092	8092					
47.0	C	10	T110C476K020AS	4.5	6	2295	2535	2775	3015	6093	7093	8093					
47.0	C	20	T110C476M020AS	4.5	6	2296	2536	2776	3016	6094	7094	8094					
56.0	D	5	T110D566J020AS	5.5	6	5039	5239	5439	5639	6095	7095	8095					
56.0	D	10	T110D566K020AS	5.5	6	2297	2537	2777	3017	6096	7096	8096					
56.0	D	20	T110D566M020AS	5.5	6												
68.0	D	5	T110D686J020AS	6.0	6	5040	5240	5440	5640	6097	7097	8097					
68.0	D	10	T110D686K020AS	6.0	6	2298	2538	2778	3018	6098	7098	8098					
68.0	D	20	T110D686M020AS	6.0	6	2299	2539	2779	3019	6099	7099	8099					
82.0	D	5	T110D826J020AS	6.0	6	5041	5241	5441	5641	6100	7100	8100					
82.0	D	10	T110D826K020AS	6.0	6	2300	2540	2780	3020	6101	7101	8101					
82.0	D	20	T110D826M020AS	6.0	6												
100.0	D	5	T110D107J020AS	10.0	6	5042	5242	5442	5642	6102	7102	8102					
100.0	D	10	T110D107K020AS	10.0	6	2301	2541	2781	3021	6103	7103	8103					
100.0	D	20	T110D107M020AS	10.0	6	2302	2542	2782	3022	6104	7104	8104					

35 VOLT RATING AT 85°C — 23 VOLT RATING AT 125°C

0.0047	A	5,10,20	T110A472(1)035AS	0.1	3												
0.0056	A	5,10,20	T110A562(1)035AS	0.1	3												
0.0068	A	5,10,20	T110A682(1)035AS	0.1	3												
0.0082	A	5,10,20	T110A822(1)035AS	0.1	3												
0.01	A	5,10,20	T110A103(1)035AS	0.1	3												
0.012	A	5,10,20	T110A123(1)035AS	0.1	3												
0.015	A	5,10,20	T110A153(1)035AS	0.1	3												
0.018	A	5,10,20	T110A183(1)035AS	0.1	3												
0.022	A	5,10,20	T110A223(1)035AS	0.1	3												
0.027	A	5,10,20	T110A273(1)035AS	0.1	3												
0.033	A	5,10,20	T110A333(1)035AS	0.1	3												
0.039	A	5,10,20	T110A393(1)035AS	0.1	3												
0.047	A	5,10,20	T110A473(1)035AS	0.1	3												
0.056	A	5,10,20	T110A563(1)035AS	0.1	3												

(1) To complete T110 Series part number, insert Capacitance Tolerance Symbol in the 9th Character as shown on Page 6.

(2) To complete the T212 Series Part Number, insert Failure Rate Symbol in the 13th Character.

Bold Face lines indicate popular part types and values.

0.12	A	5,10,20	T110A124(1)035AS	0.5	3										
0.15	A	5,10,20	T110A154(1)035AS	0.5	3										
0.18	A	5,10,20	T110A184(1)035AS	0.5	3										
0.22	A	5,10,20	T110A224(1)035AS	0.5	3										
0.27	A	5,10,20	T110A274(1)035AS	0.5	3										
0.33	A	5,10,20	T110A334(1)035AS	0.5	3										
0.39	A	5,10,20	T110A394(1)035AS	0.5	3										
0.47	A	5,10,20	T110A474(1)035AS	0.5	3										
0.56	A	5,10,20	T110A564(1)035AS	0.5	3										
0.68	A	5,10,20	T110A684(1)035AS	0.5	3										
0.82	A	5,10,20	T110A824(1)035AS	0.5	3										
1.0	A	5,10,20	T110A105(1)035AS	0.5	3										
1.2	B	5,10,20	T110B125(1)035AS	0.5	4										
1.5	B	5,10,20	T110B155(1)035AS	0.5	4										
1.8	B	5,10,20	T110B185(1)035AS	0.5	4										
2.2	B	5,10,20	T110B225(1)035AS	1.0	4										
2.7	B	5,10,20	T110B275(1)035AS	1.0	4										
3.3	B	5,10,20	T110B335(1)035AS	1.0	4										
3.9	B	5,10,20	T110B395(1)035AS	1.0	4										
4.7	B	5,10,20	T110B475(1)035AS	1.0	4										
5.6	B	5	T110B565J035AS	1.0	4	5043	5243	5443	5643	6105	7105	8105			
5.6	B	10	T110B565K035AS	1.0	4	2303	2543	2783	3023	6106	7106	8106			
5.6	B	20	T110B565M035AS	1.0	4										
6.8	B	5	T110B685J035AS	1.5	4	5044	5244	5444	5644	6107	7107	8107			
6.8	B	10	T110B685K035AS	1.5	4	2304	2544	2784	3024	6108	7108	8108			
6.8	B	20	T110B685M035AS	1.5	4	2305	2545	2785	3025	6109	7109	8109			
8.2	C	5,10,20	T110C825(1)035AS	3.0	4										
10.0	C	5,10,20	T110C106(1)035AS	3.0	4										
12.0	C	5,10,20	T110C126(1)035AS	3.0	4										
15.0	C	5,10,20	T110C156(1)035AS	3.0	4										
18.0	C	5,10,20	T110C186(1)035AS	3.0	4										
22.0	C	5	T110C226J035AS	4.0	4	5045	5245	5445	5645	6110	7110	8110			
22.0	C	10	T110C226K035AS	4.0	4	2306	2546	2786	3026	6111	7111	8111			
22.0	C	20	T110C226M035AS	4.0	4	2307	2547	2787	3027	6112	7112	8112			
27.0	D	5	T110D276J035AS	4.5	4	5046	5246	5446	5646	6113	7113	8113			
27.0	D	10	T110D276K035AS	4.5	4	2308	2548	2788	3028	6114	7114	8114			
27.0	D	20	T110D276M035AS	4.5	4										
33.0	D	5	T110D336J035AS	5.5	4	5047	5247	5447	5647	6115	7115	8115			
33.0	D	10	T110D336K035AS	5.5	4	2309	2549	2789	3029	6116	7116	8116			
33.0	D	20	T110D336M035AS	5.5	4	2310	2550	2790	3030	6117	7117	8117			
39.0	D	5	T110D396J035AS	6.0	4	5048	5248	5448	5648	6118	7118	8118			
39.0	D	10	T110D396K035AS	6.0	4	2311	2551	2791	3031	6119	7119	8119			
39.0	D	20	T110D396M035AS	6.0	4										
47.0	D	5	T110D476J035AS	8.0	4	5049	5249	5449	5649	6120	7120	8120			
47.0	D	10	T110D476K035AS	8.0	4	2312	2552	2792	3032	6121	7121	8121			
47.0	D	20	T110D476M035AS	8.0	4	2313	2553	2793	3033	6122	7122	8122			
50 VOLT RATING AT 85°C — 33 VOLT RATING AT 125°															
0.0047	A	5	T110A472J050AS	0.1	2	5050	5250	5450	5650	6123	7123	8123			
0.0047	A	10	T110A472K050AS	0.1	2	2314	2554	2794	3034	6124	7124	8124			
0.0047	A	20	T110A472M050AS	0.1	2	2315	2555	2795	3035	6125	7125	8125			
0.0056	A	5	T110A562J050AS	0.1	2	5051	5251	5451	5651	6126	7126	8126			
0.0056	A	10	T110A562K050AS	0.1	2	2316	2556	2796	3036	6127	7127	8127			
0.0056	A	20	T110A562M050AS	0.1	2										
0.0068	A	5	T110A682J050AS	0.1	2	5052	5252	5452	5652	6128	7128	8128			
0.0068	A	10	T110A682K050AS	0.1	2	2317	2557	2797	3037	6129	7129	8129			
0.0068	A	20	T110A682M050AS	0.1	2	2318	2558	2798	3038	6130	7130	8130			

(1) To complete T110 Series Part Number, insert Capacitance Tolerance Symbol in the 9th Character as shown on Page 6.

(2) To complete the T212 Series Part Number, insert Failure Rate Symbol in the 13th Character.

Bold Face lines indicate popular part types and values.

0.01	A	5	T110A103J050AS	0.1	2	5054	5254	5454	5654	6133	7133	81
0.01	A	10	T110A103K050AS	0.1	2	2320	2560	2800	3040	6134	7134	81
0.01	A	20	T110A103M050AS	0.1	2	2321	2561	2801	3041	6135	7135	81
0.012	A	5	T110A123J050AS	0.1	2	5055	5255	5455	5655	6136	7136	81
0.012	A	10	T110A123K050AS	0.1	2	2322	2562	2802	3042	6137	7137	81
0.012	A	20	T110A123M050AS	0.1	2							
0.015	A	5	T110A153J050AS	0.1	2	5056	5256	5456	5656	6138	7138	81
0.015	A	10	T110A153K050AS	0.1	2	2323	2563	2803	3043	6139	7139	81
0.015	A	20	T110A153M050AS	0.1	2	2324	2564	2804	3044	6140	7140	81
0.018	A	5	T110A183J050AS	0.1	2	5057	5257	5457	5657	6141	7141	81
0.018	A	10	T110A183K050AS	0.1	2	2325	2565	2805	3045	6142	7142	81
0.018	A	20	T110A183M050AS	0.1	2							
0.022	A	5	T110A223J050AS	0.1	2	5058	5258	5458	5658	6143	7143	81
0.022	A	10	T110A223K050AS	0.1	2	2326	2566	2806	3046	6144	7144	81
0.022	A	20	T110A223M050AS	0.1	2	2327	2567	2807	3047	6145	7145	81
0.027	A	5	T110A273J050AS	0.1	2	5059	5259	5459	5659	6146	7146	81
0.027	A	10	T110A273K050AS	0.1	2	2328	2568	2808	3048	6147	7147	81
0.027	A	20	T110A273M050AS	0.1	2							
0.033	A	5	T110A333J050AS	0.1	2	5060	5260	5460	5660	6148	7148	81
0.033	A	10	T110A333K050AS	0.1	2	2329	2569	2809	3049	6149	7149	81
0.033	A	20	T110A333M050AS	0.1	2	2330	2570	2810	3050	6150	7150	81
0.039	A	5	T110A393J050AS	0.1	2	5061	5261	5461	5661	6151	7151	81
0.039	A	10	T110A393K050AS	0.1	2	2331	2571	2811	3051	6152	7152	81
0.039	A	20	T110A393M050AS	0.1	2							
0.047	A	5	T110A473J050AS	0.1	2	5062	5262	5462	5662	6153	7153	81
0.047	A	10	T110A473K050AS	0.1	2	2332	2572	2812	3052	6154	7154	81
0.047	A	20	T110A473M050AS	0.1	2	2333	2573	2813	3053	6155	7155	81
0.056	A	5	T110A563J050AS	0.1	2	5063	5263	5463	5663	6156	7156	81
0.056	A	10	T110A563K050AS	0.1	2	2334	2574	2814	3054	6157	7157	81
0.056	A	20	T110A563M050AS	0.1	2							
0.068	A	5	T110A683J050AS	0.1	2	5064	5264	5464	5664	6158	7158	81
0.068	A	10	T110A683K050AS	0.1	2	2335	2575	2815	3055	6159	7159	81
0.068	A	20	T110A683M050AS	0.1	2	2336	2576	2816	3056	6160	7160	81
0.082	A	5	T110A823J050AS	0.1	2	5065	5265	5465	5665	6161	7161	81
0.082	A	10	T110A823K050AS	0.1	2	2337	2577	2817	3057	6162	7162	81
0.082	A	20	T110A823M050AS	0.1	2							
0.1	A	5	T110A104J050AS	0.3	2	5066	5266	5466	5666	6163	7163	81
0.1	A	10	T110A104K050AS	0.3	2	2338	2578	2818	3058	6164	7164	81
0.1	A	20	T110A104M050AS	0.3	2	2339	2579	2819	3059	6165	7165	81
0.12	A	5	T110A124J050AS	0.3	2	5067	5267	5467	5667	6166	7166	81
0.12	A	10	T110A124K050AS	0.3	2	2340	2580	2820	3060	6167	7167	81
0.12	A	20	T110A124M050AS	0.3	2							
0.15	A	5	T110A154J050AS	0.3	2	5068	5268	5468	5668	6168	7168	81
0.15	A	10	T110A154K050AS	0.3	2	2341	2581	2821	3061	6169	7169	81
0.15	A	20	T110A154M050AS	0.3	2	2342	2582	2822	3062	6170	7170	81
0.18	A	5	T110A184J050AS	0.3	2	5069	5269	5469	5669	6171	7171	81
0.18	A	10	T110A184K050AS	0.3	2	2343	2583	2823	3063	6172	7172	81
0.18	A	20	T110A184M050AS	0.3	2							
0.22	A	5	T110A224J050AS	0.3	2	5070	5270	5470	5670	6173	7173	81
0.22	A	10	T110A224K050AS	0.3	2	2344	2584	2824	3064	6174	7174	81
0.22	A	20	T110A224M050AS	0.3	2	2345	2585	2825	3065	6175	7175	81
0.27	A	5	T110A274J050AS	0.3	2	5071	5271	5471	5671	6176	7176	81
0.27	A	10	T110A274K050AS	0.3	2	2346	2586	2826	3066	6177	7177	81
0.27	A	20	T110A274M050AS	0.3	2							
0.33	A	5	T110A334J050AS	0.3	2	5072	5272	5472	5672	6178	7178	81
0.33	A	10	T110A334K050AS	0.3	2	2347	2587	2827	3067	6179	7179	81
0.33	A	20	T110A334M050AS	0.3	2	2348	2588	2828	3068	6180	7180	81
0.39	A	5	T110A394J050AS	0.3	2	5073	5273	5473	5673	6181	7181	81

(1) To complete T110 Series part number, insert Capacitance Tolerance Symbol in the 9th Character as shown on Page 6.

(2) To complete the T212 Series Part Number, insert Failure Rate Symbol in the 13th Character.

Bold Face lines indicate popular part types and values.

0.47	A	10	T110A474K050AS	0.3	2	2350	2590	2830	3070	6184	7184	81
0.47	A	20	T110A474M050AS	0.3	2	2351	2591	2831	3071	6185	7185	81
0.56	A	5	T110A564J050AS	0.3	2	5075	5275	5475	5675	6186	7186	81
0.56	A	10	T110A564K050AS	0.3	2	2352	2592	2832	3072	6187	7187	81
0.56	A	20	T110A564M050AS	0.3	2							
0.68	A	5	T110A684J050AS	0.3	2	5076	5276	5476	5676	6188	7188	81
0.68	A	10	T110A684K050AS	0.3	2	2353	2593	2833	3073	6189	7189	81
0.68	A	20	T110A684M050AS	0.3	2	2354	2594	2834	3074	6190	7190	81
0.82	A	5	T110A824J050AS	0.3	2	5077	5277	5477	5677	6191	7191	81
0.82	A	10	T110A824K050AS	0.3	2	2355	2595	2835	3075	6192	7192	81
0.82	A	20	T110A824M050AS	0.3	2							
1.0	A	5	T110A105J050AS	0.4	2	5078	5278	5478	5678	6193	7193	81
1.0	A	10	T110A105K050AS	0.4	2	2356	2596	2836	3076	6194	7194	81
1.0	A	20	T110A105M050AS	0.4	2	2357	2597	2837	3077	6195	7195	81
1.2	B	5	T110B125J050AS	0.4	4	5079	5279	5479	5679	6196	7196	81
1.2	B	10	T110B125K050AS	0.4	4	2358	2598	2838	3078	6197	7197	81
1.2	B	20	T110B125M050AS	0.4	4							
1.5	B	5	T110B155J050AS	0.5	4	5080	5280	5480	5680	6198	7198	81
1.5	B	10	T110B155K050AS	0.5	4	2359	2599	2839	3079	6199	7199	81
1.5	B	20	T110B155M050AS	0.5	4	2360	2600	2840	3080	6200	7200	82
1.8	B	5	T110B185J050AS	0.5	4	5081	5281	5481	5681	6201	7201	82
1.8	B	10	T110B185K050AS	0.5	4	2361	2601	2841	3081	6202	7202	82
1.8	B	20	T110B185M050AS	0.5	4							
2.2	B	5	T110B225J050AS	0.8	4	5082	5282	5482	5682	6203	7203	82
2.2	B	10	T110B225K050AS	0.8	4	2362	2602	2842	3082	6204	7204	82
2.2	B	20	T110B225M050AS	0.8	4	2363	2603	2843	3083	6205	7205	82
2.7	B	5	T110B275J050AS	0.8	4	5083	5283	5483	5683	6206	7206	82
2.7	B	10	T110B275K050AS	0.8	4	2364	2604	2844	3084	6207	7207	82
2.7	B	20	T110B275M050AS	0.8	4							
3.3	B	5	T110B335J050AS	1.2	4	5084	5284	5484	5684	6208	7208	82
3.3	B	10	T110B335K050AS	1.2	4	2365	2605	2845	3085	6209	7209	82
3.3	B	20	T110B335M050AS	1.2	4	2366	2606	2846	3086	6210	7210	82
3.9	B	5	T110B395J050AS	1.5	4	5085	5285	5485	5685	6211	7211	82
3.9	B	10	T110B395K050AS	1.5	4	2367	2607	2847	3087	6212	7212	82
3.9	B	20	T110B395M050AS	1.5	4							
4.7	B	5	T110B475J050AS	1.7	4	5086	5286	5486	5686	6213	7213	82
4.7	B	10	T110B475K050AS	1.7	4	2368	2608	2848	3088	6214	7214	82
4.7	B	20	T110B475M050AS	1.7	4	2369	2609	2849	3089	6215	7215	82
5.6	C	5	T110C565J050AS	2.2	4	5087	5287	5487	5687	6216	7216	82
5.6	C	10	T110C565K050AS	2.2	4	2370	2610	2850	3090	6217	7217	82
5.6	C	20	T110C565M050AS	2.2	4							
6.8	C	5	T110C685J050AS	2.2	4	5088	5288	5488	5688	6218	7218	82
6.8	C	10	T110C685K050AS	2.2	4	2371	2611	2851	3091	6219	7219	82
6.8	C	20	T110C685M050AS	2.2	4	2372	2612	2852	3092	6220	7220	82
8.2	C	5	T110C825J050AS	2.5	4	5089	5289	5489	5689	6221	7221	82
8.2	C	10	T110C825K050AS	2.5	4	2373	2613	2853	3093	6222	7222	82
8.2	C	20	T110C825M050AS	2.5	4							
10.0	C	5	T110C106J050AS	2.5	4	5090	5290	5490	5690	6223	7223	82
10.0	C	10	T110C106K050AS	2.5	4	2374	2614	2854	3094	6224	7224	82
10.0	C	20	T110C106M050AS	2.5	4	2375	2615	2855	3095	6225	7225	82
12.0	C	5	T110C126J050AS	3.0	4	5091	5291	5491	5691	6226	7226	82
12.0	C	10	T110C126K050AS	3.0	4	2376	2616	2856	3096	6227	7227	82
12.0	C	20	T110C126M050AS	3.0	4							
15.0	C	5	T110C156J050AS	4.0	4	5092	5292	5492	5692	6228	7228	82
15.0	C	10	T110C156K050AS	4.0	4	2377	2617	2857	3097	6229	7229	82
15.0	C	20	T110C156M050AS	4.0	4	2378	2618	2858	3098	6230	7230	82
18.0	C	5	T110C186J050AS	4.5	4	5093	5293	5493	5693	6231	7231	82

(1) To complete T110 Series part number, insert Capacitance Tolerance Symbol in the 9th Character as shown on Page 6.

(2) To complete the T212 Series Part Number, insert Failure Rate Symbol in the 13th Character.

Bold Face lines indicate popular part type and values.

22.0	D	10	T110D226M050AS	5.5	4	2381	2621	2861	3101	6235	7235	82
60 VOLT RATING AT 85°C — 40 VOLT RATING AT 125°C												
0.0047	A	5,10,20	T110A472(1)060AS	0.3	3							
0.0056	A	5,10,20	T110A562(1)060AS	0.3	3							
0.0068	A	5,10,20	T110A682(1)060AS	0.3	3							
0.0082	A	5,10,20	T110A822(1)060AS	0.3	3							
0.01	A	5,10,20	T110A103(1)060AS	0.3	3							
0.012	A	5,10,20	T110A123(1)060AS	0.3	3							
0.015	A	5,10,20	T110A153(1)060AS	0.3	3							
0.018	A	5,10,20	T110A183(1)060AS	0.3	3							
0.022	A	5,10,20	T110A223(1)060AS	0.3	3							
0.027	A	5,10,20	T110A273(1)060AS	0.3	3							
0.033	A	5,10,20	T110A333(1)060AS	0.3	3							
0.039	A	5,10,20	T110A393(1)060AS	0.3	3							
0.047	A	5,10,20	T110A473(1)060AS	0.3	3							
0.056	A	5,10,20	T110A563(1)060AS	0.3	3							
0.068	A	5,10,20	T110A683(1)060AS	0.3	3							
0.082	A	5,10,20	T110A823(1)060AS	0.3	3							
0.1	A	5,10,20	T110A104(1)060AS	0.5	3							
0.12	A	5,10,20	T110A124(1)060AS	0.5	3							
0.15	A	5,10,20	T110A154(1)060AS	0.5	3							
0.18	A	5,10,20	T110A184(1)060AS	0.5	3							
0.22	A	5,10,20	T110A224(1)060AS	0.5	3							
0.27	A	5,10,20	T110A274(1)060AS	0.5	3							
0.33	A	5,10,20	T110A334(1)060AS	0.5	3							
0.39	A	5,10,20	T110A394(1)060AS	0.5	3							
0.47	A	5,10,20	T110A474(1)060AS	0.5	3							
0.56	A	5,10,20	T110A564(1)060AS	0.5	3							
0.68	A	5,10,20	T110A684(1)060AS	0.5	3							
0.82	B	5,10,20	T110B824(1)060AS	0.5	3							
1.0	B	5,10,20	T110B105(1)060AS	0.5	3							
1.2	B	5,10,20	T110B125(1)060AS	0.5	4							
1.5	B	5,10,20	T110B155(1)060AS	0.5	4							
1.8	B	5,10,20	T110B185(1)060AS	0.5	4							
2.2	B	5,10,20	T110B225(1)060AS	1.0	4							
2.7	B	5,10,20	T110B275(1)060AS	1.0	4							
3.3	B	5,10,20	T110B335(1)060AS	1.5	4							
3.9	B	5,10,20	T110B395(1)060AS	1.5	4							
4.7	C	5,10,20	T110C475(1)060AS	2.0	4							
5.6	C	5,10,20	T110C565(1)060AS	2.0	4							
6.8	C	5,10,20	T110C685(1)060AS	3.0	4							
8.2	C	5,10,20	T110C825(1)060AS	4.0	4							
10.0	C	5,10,20	T110C106(1)060AS	5.0	4							
12.0	C	5,10,20	T110C126(1)060AS	5.0	4							
15.0	D	5,10,20	T110D156(1)060AS	4.0	4							
18.0	D	5,10,20	T110D186(1)060AS	5.0	4							
22.0	D	5,10,20	T110D226(1)060AS	6.0	4							
75 VOLT RATING AT 85°C — 50 VOLT RATING AT 125°C												
0.0047	A	5,10,20	T110A472(1)075AS	0.3	2							
0.0056	A	5,10,20	T110A562(1)075AS	0.3	2							
0.0068	A	5,10,20	T110A682(1)075AS	0.3	2							
0.0082	A	5,10,20	T110A822(1)075AS	0.3	2							
0.01	A	5,10,20	T110A103(1)075AS	0.3	2							

(1) To complete T110 Series part number, insert Capacitance Tolerance Symbol in the 9th Character as shown on Page 6.

(2) To complete the T212 Series Part Number, insert Failure Rate Symbol in the 13th Character.

Bold Face lines indicate popular part types and values.

2.7	B	20	T110B275M075AS	1.2	4							
3.3	B	5	T110B335J075AS	1.2	4	5113	5313	5513	5713	6281	7281	8281
3.3	B	10	T110B335K075AS	1.2	4	2409	2649	2889	3129	6282	7282	8282
3.3	B	20	T110B335M075AS	1.2	4	2410	2650	2890	3130	6283	7283	8283
3.9	B	5	T110B395J075AS	1.5	4	5114	5314	5514	5714	6284	7284	8284
3.9	B	10	T110B395K075AS	1.5	4	2411	2651	2891	3131	6285	7285	8285
3.9	B	20	T110B395M075AS	1.5	4							
4.7	C	5	T110C475J075AS	3.0	4	5115	5315	5515	5715	6286	7286	8286
4.7	C	10	T110C475K075AS	3.0	4	2412	2652	2892	3132	6287	7287	8287
4.7	C	20	T110C475M075AS	3.0	4	2413	2653	2893	3133	6288	7288	8288
5.6	C	5	T110C565J075AS	3.0	4	5116	5316	5516	5716	6289	7289	8289
5.6	C	10	T110C565K075AS	3.0	4	2414	2654	2894	3134	6290	7290	8290
5.6	C	20	T110C565M075AS	3.0	4							
6.8	C	5	T110C685J075AS	5.0	4	5117	5317	5517	5717	6291	7291	8291
6.8	C	10	T110C685K075AS	5.0	4	2415	2655	2895	3135	6292	7292	8292
6.8	C	20	T110C685M075AS	5.0	4	2416	2656	2896	3136	6293	7293	8293
8.2	C	5	T110C825J075AS	5.0	4	5118	5318	5518	5718	6294	7294	8294
8.2	C	10	T110C825K075AS	5.0	4	2417	2657	2897	3137	6295	7295	8295
8.2	C	20	T110C825M075AS	5.0	4							
10.0	C	5	T110C106J075AS	5.0	4	5119	5319	5519	5719	6296	7296	8296
10.0	C	10	T110C106K075AS	5.0	4	2418	2658	2898	3138	6297	7297	8297
10.0	C	20	T110C106M075AS	5.0	4	2419	2659	2899	3139	6298	7298	8298
12.0	D	5	T110D126J075AS	5.0	4	5120	5320	5520	5720	6299	7299	8299
12.0	D	10	T110D126K075AS	5.0	4	2420	2660	2900	3140	6300	7300	8300
12.0	D	20	T110D126M075AS	5.0	4							
15.0	D	5	T110D156J075AS	7.0	4	5121	5321	5521	5721	6301	7301	8301
15.0	D	10	T110D156K075AS	7.0	4	2421	2661	2901	3141	6302	7302	8302
15.0	D	20	T110D156M075AS	7.0	4	2422	2662	2902	3142	6303	7303	8303

100 VOLT RATING AT 85°C — 67 VOLT RATING AT 125°

0.0047	A	5	T110A472J100AS	0.3	2	5122	5322	5522	5722	6304	7304	8304
0.0047	A	10	T110A472K100AS	0.3	2	2423	2663	2903	3143	6305	7305	8305
0.0047	A	20	T110A472M100AS	0.3	2	2424	2664	2904	3144	6306	7306	8306
0.0056	A	5	T110A562J100AS	0.3	2	5123	5323	5523	5723	6307	7307	8307
0.0056	A	10	T110A562K100AS	0.3	2	2425	2665	2905	3145	6308	7308	8308
0.0056	A	20	T110A562M100AS	0.3	2							
0.0068	A	5	T110A682J100AS	0.3	2	5124	5324	5524	5724	6309	7309	8309
0.0068	A	10	T110A682K100AS	0.3	2	2426	2666	2906	3146	6310	7310	8310
0.0068	A	20	T110A682M100AS	0.3	2	2427	2667	2907	3147	6311	7311	8311
0.0082	A	5	T110A822J100AS	0.3	2	5125	5325	5525	5725	6312	7312	8312
0.0082	A	10	T110A822K100AS	0.3	2	2428	2668	2908	3148	6313	7313	8313
0.0082	A	20	T110A822M100AS	0.3	2							
0.01	A	5	T110A103J100AS	0.3	2	5126	5326	5526	5726	6314	7314	8314
0.01	A	10	T110A103K100AS	0.3	2	2429	2669	2909	3149	6315	7315	8315
0.01	A	20	T110A103M100AS	0.3	2	2430	2670	2910	3150	6316	7316	8316
0.012	A	5	T110A123J100AS	0.3	2	5127	5327	5527	5727	6317	7317	8317
0.012	A	10	T110A123K100AS	0.3	2	2431	2671	2911	3151	6318	7318	8318
0.012	A	20	T110A123M100AS	0.3	2							
0.015	A	5	T110A153J100AS	0.3	2	5128	5328	5528	5728	6319	7319	8319
0.015	A	10	T110A153K100AS	0.3	2	2432	2672	2912	3152	6320	7320	8320
0.015	A	20	T110A153M100AS	0.3	2	2433	2673	2913	3153	6321	7321	8321
0.018	A	5	T110A183J100AS	0.3	2	5129	5329	5529	5729	6322	7322	8322
0.018	A	10	T110A183K100AS	0.3	2	2434	2674	2914	3154	6323	7323	8323
0.018	A	20	T110A183M100AS	0.3	2							
0.022	A	5	T110A223J100AS	0.3	2	5130	5330	5530	5730	6324	7324	8324
0.022	A	10	T110A223K100AS	0.3	2	2435	2675	2915	3155	6325	7325	8325

(1) To complete T110 Series part number, insert Capacitance Tolerance Symbol in the 9th Character as shown on Page 6.

(2) To complete the T212 Series Part Number, insert Failure Rate Symbol in the 13th Character.

Bold Face lines indicate popular part types and values.

*Note: D Failure Rate — Not QPL for -8304 thru -8401.

0.027	A	20	T110A273M100AS	0.3	2						
0.033	A	5	T110A333J100AS	0.3	2	5132	5332	5532	5732	6329	7329
0.033	A	10	T110A333K100AS	0.3	2	2438	2678	2918	3158	6330	7330
0.033	A	20	T110A333M100AS	0.3	2	2439	2679	2919	3159	6331	7331
0.039	A	5	T110A393J100AS	0.3	2	5133	5333	5533	5733	6332	7332
0.039	A	10	T110A393K100AS	0.3	2	2440	2680	2920	3160	6333	7333
0.039	A	20	T110A393M100AS	0.3	2						
0.047	A	5	T110A473J100AS	0.3	2	5134	5334	5534	5734	6334	7334
0.047	A	10	T110A473K100AS	0.3	2	2441	2681	2921	3161	6335	7335
0.047	A	20	T110A473M100AS	0.3	2	2442	2682	2922	3162	6336	7336
0.056	A	5	T110A563J100AS	0.3	2	5135	5335	5535	5735	6337	7337
0.056	A	10	T110A563K100AS	0.3	2	2443	2683	2923	3163	6338	7338
0.056	A	20	T110A563M100AS	0.3	2						
0.068	A	5	T110A683J100AS	0.3	2	5136	5336	5536	5736	6339	7339
0.068	A	10	T110A683K100AS	0.3	2	2444	2684	2924	3164	6340	7340
0.068	A	20	T110A683M100AS	0.3	2	2445	2685	2925	3165	6341	7341
0.082	A	5	T110A823J100AS	0.3	2	5137	5337	5537	5737	6342	7342
0.082	A	10	T110A823K100AS	0.3	2	2446	2686	2926	3166	6343	7343
0.082	A	20	T110A823M100AS	0.3	2						
0.1	A	5	T110A104J100AS	0.3	2	5138	5338	5538	5738	6344	7344
0.1	A	10	T110A104K100AS	0.3	2	2447	2687	2927	3167	6345	7345
0.1	A	20	T110A104M100AS	0.3	2	2448	2688	2928	3168	6346	7346
0.12	A	5	T110A124J100AS	0.3	2	5139	5339	5539	5739	6347	7347
0.12	A	10	T110A124K100AS	0.3	2	2449	2689	2929	3169	6348	7348
0.12	A	20	T110A124M100AS	0.3	2						
0.15	A	5	T110A154J100AS	0.3	2	5140	5340	5540	5740	6349	7349
0.15	A	10	T110A154K100AS	0.3	2	2450	2690	2930	3170	6350	7350
0.15	A	20	T110A154M100AS	0.3	2	2451	2691	2931	3171	6351	7351
0.18	A	5	T110A184J100AS	0.3	2	5141	5341	5541	5741	6352	7352
0.18	A	10	T110A184K100AS	0.3	2	2452	2692	2932	3172	6353	7353
0.18	A	20	T110A184M100AS	0.3	2						
0.22	A	5	T110A224J100AS	0.3	2	5142	5342	5542	5742	6354	7354
0.22	A	10	T110A224K100AS	0.3	2	2453	2693	2933	3173	6355	7355
0.22	A	20	T110A224M100AS	0.3	2	2454	2694	2934	3174	6356	7356
0.27	A	5	T110A274J100AS	0.3	2	5143	5343	5543	5743	6357	7357
0.27	A	10	T110A274K100AS	0.3	2	2455	2695	2935	3175	6358	7358
0.27	A	20	T110A274M100AS	0.3	2						
0.33	A	5	T110A334J100AS	0.3	2	5144	5344	5544	5744	6359	7359
0.33	A	10	T110A334K100AS	0.3	2	2456	2696	2936	3176	6360	7360
0.33	A	20	T110A334M100AS	0.3	2	2457	2697	2937	3177	6361	7361
0.39	A	5	T110A394J100AS	0.3	2	5145	5345	5545	5745	6362	7362
0.39	A	10	T110A394K100AS	0.3	2	2458	2698	2938	3178	6363	7363
0.39	A	20	T110A394M100AS	0.3	2						
0.47	A	5	T110A474J100AS	0.3	2	5146	5346	5546	5746	6364	7364
0.47	A	10	T110A474K100AS	0.3	2	2459	2699	2939	3179	6365	7365
0.47	A	20	T110A474M100AS	0.3	2	2460	2700	2940	3180	6366	7366
0.56	A	5	T110A564J100AS	0.3	2	5147	5347	5547	5747	6367	7367
0.56	A	10	T110A564K100AS	0.3	2	2461	2701	2941	3181	6368	7368
0.56	A	20	T110A564M100AS	0.3	2						
0.68	B	5	T110B684J100AS	0.3	2	5148	5348	5548	5748	6369	7369
0.68	B	10	T110B684K100AS	0.3	2	2462	2702	2942	3182	6370	7370
0.68	B	20	T110B684M100AS	0.3	2	2463	2703	2943	3183	6371	7371
0.82	B	5	T110B824J100AS	0.4	2	5149	5349	5549	5749	6372	7372
0.82	B	10	T110B824K100AS	0.4	2	2464	2704	2944	3184	6373	7373
0.82	B	20	T110B824M100AS	0.4	2						
1.0	B	5	T110B105J100AS	0.5	2	5150	5350	5550	5750	6374	7374
1.0	B	10	T110B105K100AS	0.5	2	2465	2705	2945	3185	6375	7375
1.0	B	20	T110B105M100AS	0.5	2	2466	2706	2946	3186	6376	7376

(1) To complete T110 Series Part Number, insert Capacitance Tolerance Symbol in the 9th Character as shown on Page 6.

(2) To complete the T212 Series Part Number, insert Failure Rate Symbol in the 13th Character.

Bold Face lines indicate popular part types and values.

*Note: D Failure Rate — Not QPL for -8304 thru -8401.

KEMET Electronics Corporation, P.O. Box 5928, Greenville, S.C. 29606 (864) 963-6300

1.5	B	5	T110B155J100AS	0.7	3	5152	5352	5552	5752	6379	7379	
1.5	B	10	T110B155K100AS	0.7	3	2468	2708	2948	3188	6380	7380	
1.5	B	20	T110B155M100AS	0.7	3	2469	2709	2949	3189	6381	7381	
1.8	B	5	T110B185J100AS	0.7	3	5153	5353	5553	5753	6382	7382	
1.8	B	10	T110B185K100AS	0.7	3	2470	2710	2950	3190	6383	7383	
1.8	B	20	T110B185M100AS	0.7	3							
2.2	B	5	T110B225J100AS	0.9	3	5154	5354	5554	5754	6384	7384	
2.2	B	10	T110B225K100AS	0.9	3	2471	2711	2951	3191	6385	7385	
2.2	B	20	T110B225M100AS	0.9	3	2472	2712	2952	3192	6386	7386	
2.7	B	5	T110B275J100AS	1.1	3	5155	5355	5555	5755	6387	7387	
2.7	B	10	T110B275K100AS	1.1	3	2473	2713	2953	3193	6388	7388	
2.7	B	20	T110B275M100AS	1.1	3							
<hr/>												
3.3	C	5	T110C335J100AS	1.5	3	5156	5356	5556	5756	6389	*	
3.3	C	10	T110C335K100AS	1.5	3	5157	5357	5557	5757	6390	*	
3.3	C	20	T110C335M100AS	1.5	3	5158	5358	5558	5758	6391	*	
3.9	C	5	T110C395J100AS	1.5	3	5159	5359	5559	5759	6392	*	
3.9	C	10	T110C395K100AS	1.5	3	5160	5360	5560	5760	6393	*	
4.7	C	5	T110C475J100AS	2.5	3	5161	5361	5561	5761	6394	*	
4.7	C	10	T110C475K100AS	2.5	3	5162	5362	5562	5762	6395	*	
4.7	C	20	T110C475M100AS	2.5	3	5163	5363	5563	5763	6396	*	
5.6	C	5	T110C565J100AS	2.5	3	5164	5364	5564	5764	6397	*	
5.6	C	10	T110C565K100AS	2.5	3	5165	5365	5565	5765	6398	*	
6.8	C	5	T110C685J100AS	2.5	3	5166	5366	5566	5766	6399	*	
6.8	C	10	T110C685K100AS	2.5	3	5167	5367	5567	5767	6400	*	
6.8	C	20	T110C685M100AS	2.5	3	5168	5368	5568	5768	6401	*	
<hr/>												
8.2	D	5,10,20	T110D825(1)100AS	5.0	3							
10.0	D	5,10,20	T110D106(1)100AS	5.0	3							
<hr/>												
125 VOLT RATING AT 85°C — 82 VOLT RATING AT 125°												
<hr/>												
0.0047	A	5,10,20	T110A472(1)125AS	0.5	3							
0.0056	A	5,10,20	T110A562(1)125AS	0.5	3							
0.0068	A	5,10,20	T110A682(1)125AS	0.5	3							
0.0082	A	5,10,20	T110A822(1)125AS	0.5	3							
0.01	A	5,10,20	T110A103(1)125AS	0.5	3							
0.012	A	5,10,20	T110A123(1)125AS	0.5	3							
0.015	A	5,10,20	T110A153(1)125AS	0.5	3							
0.018	A	5,10,20	T110A183(1)125AS	0.5	3							
0.022	A	5,10,20	T110A223(1)125AS	0.5	3							
0.027	A	5,10,20	T110A273(1)125AS	0.5	3							
0.033	A	5,10,20	T110A333(1)125AS	0.5	3							
0.039	A	5,10,20	T110A393(1)125AS	1.5	3							
0.047	A	5,10,20	T110A473(1)125AS	1.5	3							
0.056	A	5,10,20	T110A563(1)125AS	1.5	3							
0.068	A	5,10,20	T110A683(1)125AS	1.5	3							
0.082	A	5,10,20	T110A823(1)125AS	1.5	3							
0.1	A	5,10,20	T110A104(1)125AS	1.5	3							
0.12	A	5,10,20	T110A124(1)125AS	1.5	3							
0.15	A	5,10,20	T110A154(1)125AS	1.5	3							
0.18	A	5,10,20	T110A184(1)125AS	1.5	3							
0.22	A	5,10,20	T110A224(1)125AS	1.5	3							
0.27	A	5,10,20	T110A274(1)125AS	1.5	3							
0.33	A	5,10,20	T110A334(1)125AS	1.5	3							
<hr/>												
0.39	B	5,10,20	T110B394(1)125AS	1.5	3							
0.47	B	5,10,20	T110B474(1)125AS	1.5	3							
0.56	B	5,10,20	T110B564(1)125AS	1.5	3							
0.68	B	5,10,20	T110B684(1)125AS	1.5	3							
0.82	B	5,10,20	T110B824(1)125AS	1.5	3							

(1) To complete T110 Series Part Number, insert Capacitance Tolerance Symbol in the 9th Character as shown on Page 6.

(2) To complete the T212 Series Part Number, insert Failure Rate Symbol in the 13th Character.

Bold Face lines indicate popular part types and values.

*Note: C failure rate — Not QPL for 7389 thru 7401.

D failure rate — Not QPL for -8304 thru -8401.

1.8	B	5,10,20	T110B185(1)125AS	1.5	3						
2.2	B	5,10,20	T110B225(1)125AS	1.5	3						
2.7	C	5,10,20	T110C275(1)125AS	2.0	3						
3.3	C	5,10,20	T110C335(1)125AS	2.0	3						
3.9	C	5,10,20	T110C395(1)125AS	2.0	3						
4.7	C	5,10,20	T110C475(1)125AS	3.0	3						
5.6	C	5,10,20	T110C565(1)125AS	3.0	3						
6.8	C	5,10,20	T110C685(1)125AS	3.0	3						
8.2	D	5,10,20	T110D825(1)125AS	6.0	3						
10.0	D	5,10,20	T110D106(1)125AS	6.0	3						

(1) To complete T110 Series Part Number, insert Capacitance Tolerance Symbol in the 9th Character as shown on Page 6.

(2) To complete the T212 Series Part Number, insert Failure Rate Symbol in the 13th Character.

Bold Face lines indicate popular part types and values.

T110/T140 Herm Seal ESR (OHMS) at 100 kHz @ +25°C

(The ESR values provided below are for reference only. No warranty, as stated on page 3 and reincorporated here, is made as to the accuracy of these values for any particular T110/T140 Series product.)

Cap. μF	6 Volt	10 Volt	15 Volt	20 Volt	30 Volt	35 Volt	50 Volt	60 Volt	75 Volt	100 Volt	125 Volt
0.10				37.0		26.0	26.0	26.0	26.0	25.0	25.0
0.12				37.0		26.0	26.0	26.0	26.0	25.0	25.0
0.15				32.0		21.0	21.0	21.0	21.0	20.0	20.0
0.18				32.0		21.0	21.0	21.0	21.0	20.0	20.0
0.22				27.0		17.0	17.0	17.0	17.0	16.0	16.0
0.27				25.0		17.0	17.0	17.0	17.0	16.0	16.0
0.33			28.0	22.0		15.0	15.0	15.0	15.0	14.0	14.0
0.39			28.0	22.0		15.0	15.0	15.0	15.0	14.0	14.0
0.47			26.0	20.0		13.0	13.0	13.0	13.0	12.0	12.0
0.56			26.0	18.0		13.0	13.0	13.0	13.0	12.0	12.0
0.68			24.0	16.0		10.0	10.0	10.0	10.0	9.0	9.0
0.82			24.0	16.0		10.0	10.0	10.0	10.0	9.0	9.0
1.00		20.0	17.0	10.0		8.0	8.0	8.0	8.0	7.0	7.0
1.20		20.0	17.0	10.0	9.0	8.0	8.0	8.0	8.0	7.0	7.0
1.50		14.0	10.0	9.0	8.0	6.0	5.0	5.0	5.0	4.0	4.0
1.80		14.0	10.0	9.0	8.0	6.0	5.0	5.0	5.0	4.0	4.0
2.20	14.0	13.0	8.0	7.0	6.0	5.0	3.5	3.5	3.5	3.0	3.0
2.70	14.0	13.0	8.0	7.0	6.0	5.0	3.5	3.5	3.5	3.0	3.0
3.30	13.0	10.0	6.0	5.5		4.0	3.0	3.0	3.0	2.5	2.5
3.90	13.0	10.0	6.0	5.5		4.0	3.0	3.0	3.0	2.5	2.5
4.70	10.0	8.0	5.0	4.5		3.0	2.5	2.5	2.5	2.0	2.0
5.60	10.0	8.0	5.0	4.5		3.0	2.5	2.5	2.5	2.0	2.0
6.80	8.0	6.0	4.0	3.6		2.5	2.0	2.0	2.0	1.5	1.5
8.20	8.0	6.0	4.0	3.6		2.5	2.0	2.0	2.0	1.5	1.5
10.0	6.0	5.0	3.2	2.9		2.0	1.6	1.6	1.6	1.0	1.0
12.0	6.0	5.0	3.2	2.9	2.5	2.0	1.6	1.6	1.6		
15.0	5.0	3.7	2.5	2.3	2.0	1.6	1.2	1.2	1.2		
18.0	5.0	3.7	2.5	2.3	2.0	1.6	1.2	1.2			
22.0	3.7	2.7	2.0	1.8		1.3	1.0	1.0			
27.0	3.7	2.7	2.0	1.8		1.3	1.0	1.0			
33.0	3.0	2.1	1.6	1.4	1.2	1.0	0.8	0.8			
39.0	3.0	2.1	1.6	1.4	1.2	1.0	0.8				
47.0	2.0	1.7	1.3	1.2	1.0	0.8	0.6				
56.0	2.0	1.7	1.3	1.2	1.0	0.8	0.6				
68.0	1.8	1.3	1.0	0.9	0.8	0.6					
82.0	1.8	1.3	1.0	0.9	0.8	0.6					
100.0	1.6	1.0	0.8	0.6	0.5						
120.0	1.6	1.0	0.8	0.6							
150.0	0.9	0.8	0.6	0.5							
180.0	0.9	0.8	0.6	0.5							
220.0	0.9	0.6	0.5								
270.0	0.9	0.6	0.5								
330.0	0.7	0.5	0.4								
390.0	0.7	0.5									
470.0	0.5	0.5									
560.0	0.5	0.5									
680.0	0.3										
820.0	0.3										
1000.0	0.12										
1200.0	0.12										

B	0.020 (.51)	0.194 (4.93)	0.916 (23.27)	0.207 (5.26)	0.955 (24.26)	1.130 (28.70)
C	0.025 (.64)	0.300 (7.62)	1.340 (34.04)	0.314 (7.98)	1.350 (34.29)	1.525 (38.74)
D	0.025 (.64)	0.362 (9.19)	1.540 (39.12)	0.376 (9.55)	1.550 (39.37)	1.725 (43.82)

9925AB Date Co

CAPACITOR OUTLINE DRAWINGS

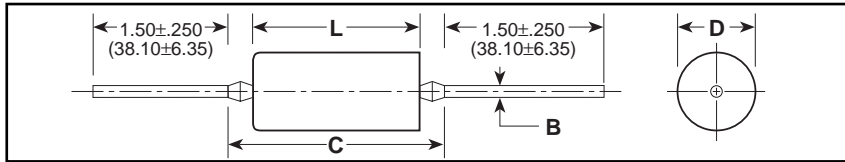

* For Military Ma

RATINGS & PART NUMBER REFERENCE

CAPACITANCE μF	CASE SIZE	CAPACITANCE TOLERANCE ±%	KEMET T111 SERIES			MIL-C-39003 (CSR91) CAPA					
			KEMET PART NUMBER	D.C. LEAKAGE μA@25°C MAX.	MAX. DISSI- PATION FACTOR %@25°C, 120Hz	DASH NUMBER REFERENCE FAILURE RATE LEVEL (%/1000 HRS.)					
						MIL-C-39003/4C EXPONENTIAL			MIL-C-39003/4 GRADED		
						M (1.0)	P (0.1)	R (0.01)	S (0.001)	B (0.1)	C (0.01)
6 VOLT RATING AT 85°C — 4 VOLT RATING AT 125°C											
2.8	A	10	T111A285K006AS	0.3	4	0221	0441	0661	0881	3001	4001
3.4	A	10	T111A345K006AS	0.3	6	0222	0442	0662	0882	3002	4002
3.4	A	20	T111A345M006AS	0.3	6	0223	0443	0663	0883	3003	4003
23.0	B	10	T111B236K006AS	1.5	6	0224	0444	0664	0884	3004	4004
23.0	B	20	T111B236M006AS	1.5	6	0225	0445	0665	0885	3005	4005
28.0	B	10	T111B286K006AS	1.5	6	0226	0446	0666	0886	3006	4006
75.0	C	10	T111C756K006AS	4.5	6	0227	0447	0667	0887	3007	4007
75.0	C	20	T111C756M006AS	4.5	6	0228	0448	0668	0888	3008	4008
90.0	C	10	T111C906K006AS	4.5	6	0229	0449	0669	0889	3009	4009
90.0	C	20	T111C906M006AS	5.5	6	0230	0450	0670	0890		
130.0	D	10	T111D137K006AS	6.0	8	0231	0451	0671	0891	3010	4010
130.0	D	20	T111D137M006AS	6.0	8	0232	0452	0672	0892		
160.0	D	10	T111D167K006AS	7.5	8	0233	0453	0673	0893	3011	4011
160.0	D	20	T111D167M006AS	7.5	8	0234	0454	0674	0894	3012	4012
10 VOLT RATING AT 85°C — 7 VOLT RATING AT 125°C											
1.9	A	10	T111A195K010AS	0.3	4	0235	0455	0675	0895	3013	4013
2.3	A	10	T111A235K010AS	0.4	4	0236	0456	0676	0896	3014	4014
2.3	A	20	T111A235M010AS	0.4	4	0237	0457	0677	0897	3015	4015
13.0	B	10	T111B136K010AS	2.0	6	0238	0458	0678	0898	3016	4016
16.0	B	10	T111B166K010AS	2.0	6	0239	0459	0679	0899	3017	4017
16.0	B	20	T111B166M010AS	2.0	6	0240	0460	0680	0900	3018	4018
19.0	B	10	T111B196K010AS	2.0	6	0241	0461	0681	0901	3019	4019
41.0	C	10	T111C416K010AS	3.0	6	0242	0462	0682	0902	3020	4020
50.0	C	10	T111C506K010AS	5.0	6	0243	0463	0683	0903	3021	4021
50.0	C	20	T111C506M010AS	5.0	6	0244	0464	0684	0904	3022	4022
60.0	C	10	T111C606K010AS	6.0	6	0245	0465	0685	0905	3023	4023
60.0	C	20	T111C606M010AS	6.0	6	0246	0466	0686	0906		
90.0	D	10	T111D906K010AS	9.0	6	0247	0467	0687	0907	3024	4024
110.0	D	10	T111D117K010AS	10.0	8	0248	0468	0688	0908	3025	4025
110.0	D	20	T111D117M010AS	10.0	8	0249	0469	0689	0909	3026	4026

(1) To complete T213 Series Part Number, insert Failure Rate Symbol in the 13th Character as shown on Page 6.
*For ordering information see page 4 (military) and page 6.

9.0	B	10	T111B90K015AS	2.0	6	0253	0473	0693	0913	3030	4030
11.0	B	10	T111B116K015AS	2.0	6	0254	0474	0694	0914	3031	4031
11.0	B	20	T111B116M015AS	2.0	6	0255	0475	0695	0915	3032	4032
28.0	C	10	T111C286K015AS	4.0	6	0256	0476	0696	0916	3033	4033
34.0	C	10	T111C346K015AS	5.0	6	0257	0477	0697	0917	3034	4034
34.0	C	20	T111C346M015AS	5.0	6	0258	0478	0698	0918	3035	4035
60.0	D	10	T111D606K015AS	6.0	6	0259	0479	0699	0919	3036	4036
75.0	D	10	T111D756K015AS	10.0	6	0260	0480	0700	0920	3037	4037
75.0	D	20	T111D756M015AS	10.0	6	0261	0481	0701	0921	3038	4038
20 VOLT RATING AT 85°C — 13 VOLT RATING AT 125°C											
0.6	A	10	T111A604K020AS	0.3	4	0262	0482	0702	0922	3039	4039
0.75	A	10	T111A754K020AS	0.3	4	0263	0483	0703	0923	3040	4040
0.75	A	20	T111A754M020AS	0.3	4	0264	0484	0704	0924	3041	4041
0.9	A	10	T111A904K020AS	0.3	4	0265	0485	0705	0925	3042	4042
1.1	A	10	T111A115K020AS	0.4	4	0266	0486	0706	0926	3043	4043
1.1	A	20	T111A115M020AS	0.4	4	0267	0487	0707	0927	3044	4044
4.1	B	10	T111B415K020AS	1.0	6	0268	0488	0708	0928	3045	4045
5.0	B	10	T111B505K020AS	1.0	6	0269	0489	0709	0929	3046	4046
5.0	B	20	T111B505M020AS	1.0	6	0270	0490	0710	0930	3047	4047
6.0	B	10	T111B605K020AS	1.0	6	0271	0491	0711	0931	3048	4048
7.5	B	10	T111B755K020AS	2.0	6	0272	0492	0712	0932	3049	4049
7.5	B	20	T111B755M020AS	2.0	6	0273	0493	0713	0933	3050	4050
13.0	C	10	T111C136K020AS	2.5	6	0274	0494	0714	0934	3051	4051
16.0	C	10	T111C166K020AS	3.0	6	0275	0495	0715	0935	3052	4052
16.0	C	20	T111C166M020AS	3.0	6	0276	0496	0716	0936	3053	4053
19.0	C	10	T111C196K020AS	3.0	6	0277	0497	0717	0937	3054	4054
23.0	C	10	T111C236K020AS	4.5	6	0278	0498	0718	0938	3055	4055
23.0	C	20	T111C236M020AS	4.5	6	0279	0499	0719	0939	3056	4056
28.0	D	10	T111D286K020AS	5.5	6	0280	0500	0720	0940	3057	4057
34.0	D	10	T111D346K020AS	6.0	6	0281	0501	0721	0941	3058	4058
34.0	D	20	T111D346M020AS	6.0	6	0282	0502	0722	0942	3059	4059
41.0	D	10	T111D416K020AS	6.0	6	0283	0503	0723	0943	3060	4060
50.0	D	10	T111D506K020AS	10.0	6	0284	0504	0724	0944	3061	4061
50.0	D	20	T111D506M020AS	10.0	6	0285	0505	0725	0945	3062	4062
35 VOLT RATING AT 85°C — 23 VOLT RATING AT 125°C											
2.8	B	10	T111B285K035AS	1.0	4	0289	0509	0729	0949	3063	4063
3.4	B	10	T111B345K035AS	1.5	4	0290	0510	0730	0950	3064	4064
3.4	B	20	T111B345M035AS	1.5	4	0291	0511	0731	0951	3065	4065
11.0	C	10	T111C116K035AS	4.0	4	0292	0512	0732	0952	3066	4066
11.0	C	20	T111C116M035AS	4.0	4	0293	0513	0733	0953	3067	4067
13.0	D	10	T111D136K035AS	4.5	4	0294	0514	0734	0954	3068	4068
16.0	D	10	T111D166K035AS	5.5	4	0295	0515	0735	0955	3069	4069
16.0	D	20	T111D166M035AS	5.5	4	0296	0516	0736	0956	3070	4070
19.0	D	10	T111D196K035AS	6.0	4	0297	0517	0737	0957	3071	4071
23.0	D	10	T111D236K035AS	8.0	4	0298	0518	0738	0958	3072	4072
23.0	D	20	T111D236M035AS	8.0	4	0299	0519	0739	0959	3073	4073
50 VOLT RATING AT 85°C — 33 VOLT RATING AT 125°C											
0.0023	A	10	T111A232K050AS	0.1	2	1171	1241	1311	1381	3074	4074
0.0023	A	20	T111A232M050AS	0.1	2	1172	1242	1312	1382	3075	4075
0.0028	A	10	T111A282K050AS	0.1	2	1173	1243	1313	1383	3076	4076
0.0034	A	10	T111A342K050AS	0.1	2	1174	1244	1314	1384	3077	4077
0.0034	A	20	T111A342M050AS	0.1	2	1175	1245	1315	1385	3078	4078
0.0041	A	10	T111A412K050AS	0.1	2	1176	1246	1316	1386	3079	4079
0.005	A	10	T111A502K050AS	0.1	2	1177	1247	1317	1387	3080	4080
0.005	A	20	T111A502M050AS	0.1	2	1178	1248	1318	1388	3081	4081
0.006	A	10	T111A602K050AS	0.1	2	1179	1249	1319	1389	3082	4082
0.0075	A	10	T111A752K050AS	0.1	2	1180	1250	1320	1390	3083	4083
0.0075	A	20	T111A752M050AS	0.1	2	1181	1251	1321	1391	3084	4084
0.009	A	10	T111A902K050AS	0.1	2	1182	1252	1322	1392	3085	4085
0.011	A	10	T111A113K050AS	0.1	2	1183	1253	1323	1393	3086	4086
0.011	A	20	T111A113M050AS	0.1	2	1184	1254	1324	1394	3087	4087
0.013	A	10	T111A133K050AS	0.1	2	1185	1255	1325	1395	3088	4088
0.016	A	10	T111A163K050AS	0.1	2	1186	1256	1326	1396	3089	4089

(1) To complete T213 Series Part Number, insert Failure Rate Symbol in the 13th Character as shown on Page 6.

0.023	A	20	T111A233M050AS	0.1	2	1190	1260	1330	1400	3093	4093
0.028	A	10	T111A283K050AS	0.1	2	1191	1261	1331	1401	3094	4094
0.034	A	10	T111A343K050AS	0.1	2	1192	1262	1332	1402	3095	4095
0.034	A	20	T111A343M050AS	0.1	2	1193	1263	1333	1403	3096	4096
0.041	A	10	T111A413K050AS	0.1	2	1194	1264	1334	1404	3097	4097
0.05	A	10	T111A503K050AS	0.3	2	1195	1265	1335	1405	3098	4098
0.05	A	20	T111A503M050AS	0.3	2	1196	1266	1336	1406	3099	4099
0.06	A	10	T111A603K050AS	0.3	2	1197	1267	1337	1407	3100	4100
0.075	A	10	T111A753K050AS	0.3	2	1198	1268	1338	1408	3101	4101
0.075	A	20	T111A753M050AS	0.3	2	1199	1269	1339	1409	3102	4102
0.09	A	10	T111A903K050AS	0.3	2	1200	1270	1340	1410	3103	4103
0.11	A	10	T111A114K050AS	0.3	2	1201	1271	1341	1411	3104	4104
0.11	A	20	T111A114M050AS	0.3	2	1202	1272	1342	1412	3105	4105
0.13	A	10	T111A134K050AS	0.3	2	1203	1273	1343	1413	3106	4106
0.16	A	10	T111A164K050AS	0.3	2	1204	1274	1344	1414	3107	4107
0.16	A	20	T111A164M050AS	0.3	2	1205	1275	1345	1415	3108	4108
0.19	A	10	T111A194K050AS	0.3	2	1206	1276	1346	1416	3109	4109
0.23	A	10	T111A234K050AS	0.3	2	1207	1277	1347	1417	3110	4110
0.23	A	20	T111A234M050AS	0.3	2	1208	1278	1348	1418	3111	4111
0.28	A	10	T111A284K050AS	0.3	2	1209	1279	1349	1419	3112	4112
0.34	A	10	T111A344K050AS	0.3	2	1210	1280	1350	1420	3113	4113
0.34	A	20	T111A344M050AS	0.3	2	1211	1281	1351	1421	3114	4114
0.41	A	10	T111A414K050AS	0.3	2	0300	0520	0740	0960	3115	4115
0.5	A	10	T111A504K050AS	0.4	2	0301	0521	0741	0961	3116	4116
0.5	A	20	T111A504M050AS	0.4	2	0302	0522	0742	0962	3117	4117
0.6	B	10	T111B604K050AS	0.4	4	1212	1282	1352	1422	3118	4118
0.6	B	20	T111B604M050AS	0.4	4						
0.75	B	10	T111B754K050AS	0.5	4	2001	2101	2201	2301	3119	4119
0.75	B	20	T111B754M050AS	0.5	4	2002	2102	2202	2302	3120	4120
0.9	B	10	T111B904K050AS	0.5	4	1215	1285	1355	1425	3121	4121
0.9	B	20	T111B904M050AS	0.5	4						
1.1	B	10	T111B115K050AS	0.8	4	1216	1286	1356	1426	3122	4122
1.1	B	20	T111B115M050AS	0.8	4	1217	1287	1357	1427	3123	4123
1.3	B	10	T111B135K050AS	1.0	4	1218	1288	1358	1428	3124	4124
1.3	B	20	T111B135M050AS	1.0	4						
1.6	B	10	T111B165K050AS	1.2	4	1219	1289	1359	1429	3125	4125
1.6	B	20	T111B165M050AS	1.2	4	1220	1290	1360	1430	3126	4126
1.9	B	10	T111B195K050AS	1.5	4	1221	1291	1361	1431	3127	4127
1.9	B	20	T111B195M050AS	1.5	4						
2.3	B	10	T111B235K050AS	1.7	4	1222	1292	1362	1432	3128	4128
2.3	B	20	T111B235M050AS	1.7	4	1223	1293	1363	1433	3129	4129
2.8	C	10	T111C285K050AS	2.2	4	1224	1294	1364	1434	3130	4130
2.8	C	20	T111C285M050AS	2.2	4						
3.4	C	10	T111C345K050AS	2.2	4	1225	1295	1365	1435	3131	4131
3.4	C	20	T111C345M050AS	2.2	4	1226	1296	1366	1436	3132	4132
4.1	C	10	T111C415K050AS	2.5	4	1227	1297	1367	1437	3133	4133
4.1	C	20	T111C415M050AS	2.5	4						
5.0	C	10	T111C505K050AS	2.5	4	1228	1298	1368	1438	3134	4134
5.0	C	20	T111C505M050AS	2.5	4	1229	1299	1369	1439	3135	4135
6.0	C	10	T111C605K050AS	3.0	4	0303	0523	0743	0963	3136	4136
6.0	C	20	T111C605M050AS	3.0	4						
7.5	C	10	T111C755K050AS	4.1	4	0304	0524	0744	0964	3137	4137
7.5	C	20	T111C755M050AS	4.1	4	0305	0525	0745	0965	3138	4138
9.0	C	10	T111C905K050AS	4.5	4	0306	0526	0746	0966	3139	4139
9.0	C	20	T111C905M050AS	4.5	4						
11.0	D	10	T111D116K050AS	5.5	4	0307	0527	0747	0967	3140	4140
11.0	D	20	T111D116M050AS	5.5	4	0308	0528	0748	0968	3141	4141
75 VOLT RATING AT 85°C — 50 VOLT RATING AT 125°C											
0.34	A	10	T111A344K075AS	0.3	2	0309	0529	0749	0969	3142	4142
0.34	A	20	T111A344M075AS	0.3	2	0310	0530	0750	0970	3143	4143
0.41	B	10	T111B414K075AS	0.3	2	2008	2108	2208	2308	3144	4144
0.5	B	10	T111B504K075AS	0.4	2	2009	2109	2209	2309	3145	4145
0.5	B	20	T111B504M075AS	0.4	2	2010	2110	2210	2310	3146	4146
0.6	B	10	T111B604K075AS	0.4	4	2011	2111	2211	2311	3147	4147
0.75	B	10	T111B754K075AS	0.6	4	2012	2112	2212	2312	3148	4148
0.75	B	20	T111B754M075AS	0.6	4	2013	2113	2213	2313	3149	4149

(1) To complete T213 Series Part Number, insert Failure Rate Symbol in the 13th Character as shown on Page 6.

1.3	B	10	T111B135K075AS	1.0	4	0311	0531	0751	0971	3154	4154
1.6	B	20	T111B165M075AS	1.2	4	0312	0532	0752	0972	3155	4155
1.9	B	10	T111B195K075AS	1.5	4	0313	0533	0753	0973	3156	4156
2.3	C	10	T111C235K075AS	3.0	4	2003	2103	2203	2303	3157	4157
2.3	C	20	T111C235M075AS	3.0	4	2004	2104	2204	2304	3158	4158
2.8	C	10	T111C285K075AS	3.0	4	2005	2105	2205	2305	3159	4159
3.4	C	10	T111C345K075AS	5.0	4	2006	2106	2206	2306	3160	4160
3.4	C	20	T111C345M075AS	5.0	4	2007	2107	2207	2307	3161	4161
4.1	C	10	T111C415K075AS	5.0	4	0314	0534	0754	0974	3162	4162
5.0	C	10	T111C505K075AS	5.0	4	0315	0535	0755	0975	3163	4163
5.0	C	20	T111C505M075AS	5.0	4	0316	0536	0756	0976	3164	4164
6.0	D	10	T111D605K075AS	5.0	4	0317	0537	0757	0977	3165	4165
7.5	D	10	T111D755K075AS	7.0	4	0318	0538	0758	0978	3166	4166
7.5	D	20	T111D755M075AS	7.0	4	0319	0539	0759	0979	3167	4167
100 VOLT RATING AT 85°C — 67 VOLT RATING AT 125°C											
0.0023	A	10	T111A232K100AS	0.3	2	0320	0540	0760	0980	3168	4168
0.0023	A	20	T111A232M100AS	0.3	2	0321	0541	0761	0981	3169	4169
0.0028	A	10	T111A282K100AS	0.3	2	0322	0542	0762	0982	3170	4170
0.0034	A	10	T111A342K100AS	0.3	2	0323	0543	0763	0983	3171	4171
0.0034	A	20	T111A342M100AS	0.3	2	0324	0544	0764	0984	3172	4172
0.0041	A	10	T111A412K100AS	0.3	2	0325	0545	0765	0985	3173	4173
0.005	A	10	T111A502K100AS	0.3	2	0326	0546	0766	0986	3174	4174
0.005	A	20	T111A502M100AS	0.3	2	0327	0547	0767	0987	3175	4175
0.006	A	10	T111A602K100AS	0.3	2	0328	0548	0768	0988	3176	4176
0.0075	A	10	T111A752K100AS	0.3	2	0329	0549	0769	0989	3177	4177
0.0075	A	20	T111A752M100AS	0.3	2	0330	0550	0770	0990	3178	4178
0.009	A	10	T111A902K100AS	0.3	2	0331	0551	0771	0991	3179	4179
0.011	A	10	T111A113K100AS	0.3	2	0332	0552	0772	0992	3180	4180
0.011	A	20	T111A113M100AS	0.3	2	0333	0553	0773	0993	3181	4181
0.013	A	10	T111A133K100AS	0.3	2	0334	0554	0774	0994	3182	4182
0.016	A	10	T111A163K100AS	0.3	2	0335	0555	0775	0995	3183	4183
0.016	A	20	T111A163M100AS	0.3	2	0336	0556	0776	0996	3184	4184
0.019	A	10	T111A193K100AS	0.3	2	0337	0557	0777	0997	3185	4185
0.023	A	10	T111A233K100AS	0.3	2	0338	0558	0778	0998	3186	4186
0.023	A	20	T111A233M100AS	0.3	2	0339	0559	0779	0999	3187	4187
0.028	A	10	T111A283K100AS	0.3	2	0340	0560	0780	1000	3188	4188
0.034	A	10	T111A343K100AS	0.3	2	0341	0561	0781	1001	3189	4189
0.034	A	20	T111A343M100AS	0.3	2	0342	0562	0782	1002	3190	4190
0.041	A	10	T111A413K100AS	0.3	2	0343	0563	0783	1003	3191	4191
0.05	A	10	T111A503K100AS	0.3	2	0344	0564	0784	1004	3192	4192
0.05	A	20	T111A503M100AS	0.3	2	0345	0565	0785	1005	3193	4193
0.06	A	10	T111A603K100AS	0.3	2	0346	0566	0786	1006	3194	4194
0.075	A	10	T111A753K100AS	0.3	2	0347	0567	0787	1007	3195	4195
0.075	A	20	T111A753M100AS	0.3	2	0348	0568	0788	1008	3196	4196
0.009	A	10	T111A903K100AS	0.3	2	0349	0569	0789	1009	3197	4197
0.011	A	10	T111A114K100AS	0.3	2	0350	0570	0790	1010	3198	4198
0.011	A	20	T111A114M100AS	0.3	2	0351	0571	0791	1011	3199	4199
0.013	A	10	T111A134K100AS	0.3	2	0352	0572	0792	1012	3200	4200
0.016	A	10	T111A164K100AS	0.3	2	0353	0573	0793	1013	3201	4201
0.016	A	20	T111A164M100AS	0.3	2	0354	0574	0794	1014	3202	4202
0.019	A	10	T111A194K100AS	0.3	2	0355	0575	0795	1015	3203	4203
0.023	A	10	T111A234K100AS	0.3	2	0356	0576	0796	1016	3204	4204
0.023	A	20	T111A234M100AS	0.3	2	0357	0577	0797	1017	3205	4205
0.028	A	10	T111A284K100AS	0.3	2	0358	0578	0798	1018	3206	4206
0.34	B	10	T111B344K100AS	0.3	2	0359	0579	0799	1019	3207	4207
0.34	B	20	T111B344M100AS	0.3	2	0360	0580	0800	1020	3208	4208
0.41	B	10	T111B414K100AS	0.4	2	0361	0581	0801	1021	3209	4209
0.5	B	10	T111B504K100AS	0.5	2	0362	0582	0802	1022	3210	4210
0.5	B	20	T111B504M100AS	0.5	2	0363	0583	0803	1023	3211	4211
0.6	B	10	T111B604K100AS	0.5	3	0364	0584	0804	1024	3212	4212
0.75	B	10	T111B754K100AS	0.7	3	0365	0585	0805	1025	3213	4213
0.75	B	20	T111B754M100AS	0.7	3	0366	0586	0806	1026	3214	4214
0.9	B	10	T111B904K100AS	0.7	3	0367	0587	0807	1027	3215	4215
1.1	B	10	T111B115K100AS	0.9	3	0368	0588	0808	1028	3216	4216
1.1	B	20	T111B115M100AS	0.9	3	0369	0589	0809	1029	3217	4217
1.3	B	10	T111B135K100AS	1.1	3	0370	0590	0810	1030	3218	4218

(1) To complete T213 Series Part Number, insert Failure Rate Symbol in the 13th Character as shown on Page 6.

*Note: D failure rate — Not QP

KEMET Electronics Corporation, P.O. Box 5928, Greenville, S.C. 29606 (864) 963-6300

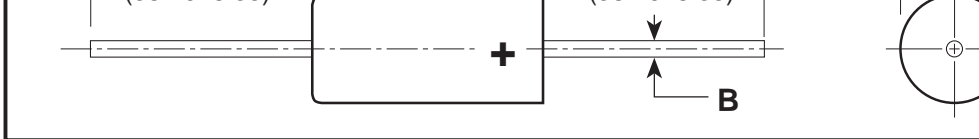

DIMENSIONS — INCHES & (MILLIMETERS)

CASE SIZE	UNINSULATED		INSULATED	
	D ±0.005 (±.13)	L	D	L
A	.085 (2.16)	.245 + .015 (6.22 + .38) - .010 (-.25)	.090 ± .009 (2.29 ± .23)	.250 + .031 (6.35 + .79) - .015 (-.38)
B	.127 (3.23)	.375 ± .015 (.53 ± .38)	.138 ± .010 (3.51 ± .25)	.390 ± .015 (9.91 ± .38)

ORDERING INFORMATION

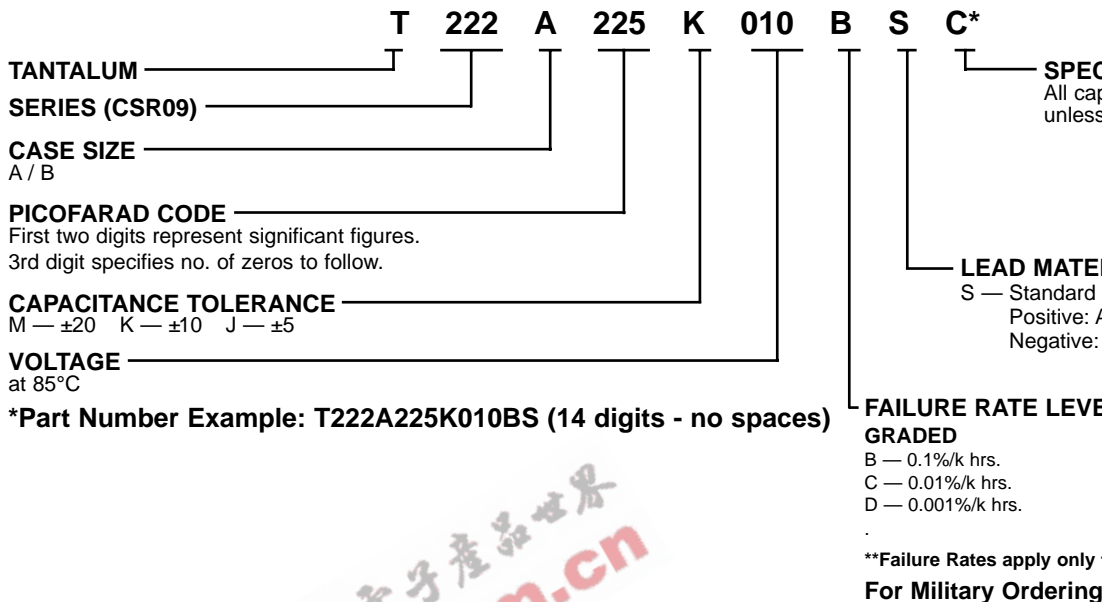

CSR09 CAPACITOR MARKINGS PER MIL-C-39003

39003	— Military specification number
02 - K	— Specification sheet number and trademark
2961J	— Nonsignificant dash number and "J" for JAN
+933	— Polarity, date code (1st digit indicates year and the next two digits indicate the week)
XX	— and lot symbol

18.0	B	10	T222B186K006(1)S	1.4	6	0002	0062	0122	0182	
10 VOLT RATING AT 85°C — 7 VOLT RATING AT 125°C										
1.8	A	5	T222A185J010(1)S	0.6	6	1007	1067	1127	1187	
1.8	A	10	T222A185K010(1)S	0.6	6	0007	0067	0127	0187	
2.2	A	5	T222A225J010(1)S	0.6	6	1008	1068	1128	1188	
2.2	A	10	T222A225K010(1)S	0.6	6	0008	0068	0128	0188	
10.0	B	5	T222B106J010(1)S	2.0	6	1009	1069	1129	1189	
10.0	B	10	T222B106K010(1)S	2.0	6	0009	0069	0129	0189	
12.0	B	5	T222B126J010(1)S	2.0	6	1010	1070	1130	1190	
12.0	B	10	T222B126K010(1)S	2.0	6	0010	0070	0130	0190	
15.0	B	5	T222B156J010(1)S	2.0	6	1011	1071	1131	1191	
15.0	B	10	T222B156K010(1)S	2.0	6	0011	0071	0131	0191	
15 VOLT RATING AT 85°C — 10 VOLT RATING AT 125°C										
1.0	A	5	T222A105J015(1)S	0.6	6	1012	1072	1132	1192	
1.0	A	10	T222A105K015(1)S	0.6	6	0012	0072	0132	0192	
1.2	A	5	T222A125J015(1)S	0.6	6	1013	1073	1133	1193	
1.2	A	10	T222A125K015(1)S	0.6	6	0013	0073	0133	0193	
1.5	A	5	T222A155J015(1)S	0.6	6	1014	1074	1134	1194	
1.5	A	10	T222A155K015(1)S	0.6	6	0014	0074	0134	0194	
8.2	B	5	T222B825J015(1)S	1.8	6	1015	1075	1135	1195	
8.2	B	10	T222B825K015(1)S	1.8	6	0015	0075	0135	0195	
20 VOLT RATING AT 85°C — 13 VOLT RATING AT 125°C										
0.56	A	5	T222A564J020(1)S	0.6	3	1016	1076	1136	1196	
0.56	A	10	T222A564K020(1)S	0.6	3	0016	0076	0136	0196	
0.68	A	5	T222A684J020(1)S	0.6	3	1017	1077	1137	1197	
0.68	A	10	T222A684K020(1)S	0.6	3	0017	0077	0137	0197	
0.82	A	5	T222A824J020(1)S	0.6	3	1018	1078	1138	1198	
0.82	A	10	T222A824K020(1)S	0.6	3	0018	0078	0138	0198	
1.0	A	5	T222A105J020(1)S	0.6	3	1019	1079	1139	1199	
1.0	A	10	T222A105K020(1)S	0.6	3	0019	0079	0139	0199	
3.3	B	5	T222B335J020(1)S	1.0	3	1020	1080	1140	1200	
3.3	B	10	T222B335K020(1)S	1.0	3	0020	0080	0140	0200	
3.9	B	5	T222B395J020(1)S	2.0	3	1021	1081	1141	1201	
3.9	B	10	T222B395K020(1)S	2.0	3	0021	0081	0141	0201	
4.7	B	5	T222B475J020(1)S	2.0	3	1022	1082	1142	1202	
4.7	B	10	T222B475K020(1)S	2.0	3	0022	0082	0142	0202	
5.6	B	5	T222B565J020(1)S	2.0	3	1023	1083	1143	1203	
5.6	B	10	T222B565K020(1)S	2.0	3	0023	0083	0143	0203	
6.8	B	5	T222B685J020(1)S	2.0	3	1024	1084	1144	1204	
6.8	B	10	T222B685K020(1)S	2.0	3	0024	0084	0144	0204	
35 VOLT RATING AT 85°C — 23 VOLT RATING AT 125°C										
0.33	A	5	T222A334J035(1)S	0.6	3	1025	1085	1145	1205	
0.33	A	10	T222A334K035(1)S	0.6	3	0025	0085	0145	0205	
0.39	A	5	T222A394J035(1)S	0.6	3	1026	1086	1146	1206	
0.39	A	10	T222A394K035(1)S	0.6	3	0026	0086	0146	0206	
0.47	A	5	T222A474J035(1)S	0.6	3	1027	1087	1147	1207	
0.47	A	10	T222A474K035(1)S	0.6	3	0027	0087	0147	0207	
2.2	B	5	T222B225J035(1)S	1.4	3	1028	1088	1148	1208	
2.2	B	10	T222B225K035(1)S	1.4	3	0028	0088	0148	0208	
2.7	B	5	T222B275J035(1)S	1.4	3	1029	1089	1149	1209	
2.7	B	10	T222B275K035(1)S	1.4	3	0029	0089	0149	0209	

(1) To complete Part Number, insert Failure Rate Symbol in the 13th Character as shown on Page 24.
Bold Face lines indicate popular part types and values

0.27	A	10	T222A274K050(1)S	0.6	3	0031	0091	0151	0211	
1.5	B	5	T222B155J050(1)S	1.4	3	1032	1092	1152	1212	
1.5	B	10	T222B155K050(1)S	1.4	3	0032	0092	0152	0212	
1.8	B	5	T222B185J050(1)S	1.4	3	1033	1093	1153	1213	
1.8	B	10	T222B185K050(1)S	1.4	3	0033	0093	0153	0213	
75 VOLT RATING AT 85°C — 50 VOLT RATING AT 125°C										
0.047	A	5	T222A473J075(1)S	0.6	3	1034	1094	1154	1214	
0.047	A	10	T222A473K075(1)S	0.6	3	0034	0094	0154	0214	
0.056	A	5	T222A563J075(1)S	0.6	3	1035	1095	1155	1215	
0.056	A	10	T222A563K075(1)S	0.6	3	0035	0095	0155	0215	
0.068	A	5	T222A683J075(1)S	0.6	3	1036	1096	1156	1216	
0.068	A	10	T222A683K075(1)S	0.6	3	0036	0096	0156	0216	
0.082	A	5	T222A823J075(1)S	0.6	3	1037	1097	1157	1217	
0.082	A	10	T222A823K075(1)S	0.6	3	0037	0097	0157	0217	
0.10	A	5	T222A104J075(1)S	0.6	3	1038	1098	1158	1218	
0.10	A	10	T222A104K075(1)S	0.6	3	0038	0098	0158	0218	
0.12	A	5	T222A124J075(1)S	0.6	3	1039	1099	1159	1219	
0.12	A	10	T222A124K075(1)S	0.6	3	0039	0099	0159	0219	
0.15	A	5	T222A154J075(1)S	0.6	3	1040	1100	1160	1220	
0.15	A	10	T222A154K075(1)S	0.6	3	0040	0100	0160	0220	
0.18	A	5	T222A184J075(1)S	0.6	3	1041	1101	1161	1221	
0.18	A	10	T222A184K075(1)S	0.6	3	0041	0101	0161	0221	
0.22	B	5	T222B224J075(1)S	0.6	3	1042	1102	1162	1222	
0.22	B	10	T222B224K075(1)S	0.6	3	0042	0102	0162	0222	
0.27	B	5	T222B274J075(1)S	0.6	3	1043	1103	1163	1223	
0.27	B	10	T222B274K075(1)S	0.6	3	0043	0103	0163	0223	
0.33	B	5	T222B334J075(1)S	0.6	3	1044	1104	1164	1224	
0.33	B	10	T222B334K075(1)S	0.6	3	0044	0104	0164	0224	
0.39	B	5	T222B394J075(1)S	0.6	3	1045	1105	1165	1225	
0.39	B	10	T222B394K075(1)S	0.6	3	0045	0105	0165	0225	
0.47	B	5	T222B474J075(1)S	0.6	3	1046	1106	1166	1226	
0.47	B	10	T222B474K075(1)S	0.6	3	0046	0106	0166	0226	
0.56	B	5	T222B564J075(1)S	0.6	3	1047	1107	1167	1227	
0.56	B	10	T222B564K075(1)S	0.6	3	0047	0107	0167	0227	
0.68	B	5	T222B684J075(1)S	0.6	3	1048	1108	1168	1228	
0.68	B	10	T222B684K075(1)S	0.6	3	0048	0108	0168	0228	
0.82	B	5	T222B824J075(1)S	0.7	3	1049	1109	1169	1229	
0.82	B	10	T222B824K075(1)S	0.7	3	0049	0109	0169	0229	
1.0	B	5	T222B105J075(1)S	0.9	3	1050	1110	1170	1230	
1.0	B	10	T222B105K075(1)S	0.9	3	0050	0110	0170	0230	
1.2	B	5	T222B125J075(1)S	0.9	3	1051	1111	1171	1231	
1.2	B	10	T222B125K075(1)S	0.9	3	0051	0111	0171	0231	

(1) To complete Part Number, insert Failure Rate Symbol in the 13th Character as shown on Page 24.
Bold Face lines indicate popular part types and values



A	0.125 (3.18)	0.250 (6.35)	0.135 (3.43)	0.286 (7.26)	0.020 (.51)	0.422 (10.72)
B	0.175 (4.45)	0.438 (11.13)	0.185 (4.70)	0.474 (12.04)	0.020 (.51)	0.610 (15.49)
C	0.279 (7.09)	0.650 (16.51)	0.289 (7.34)	0.686 (17.42)	0.025 (.64)	0.822 (20.88)
D	0.341 (8.66)	0.750 (19.05)	0.351 (8.92)	0.786 (19.96)	0.025 (.64)	0.922 (23.42)

10V — Voltage
9912RX — Date Code

* For Military

CAPACITOR OUTLINE DRAWINGS

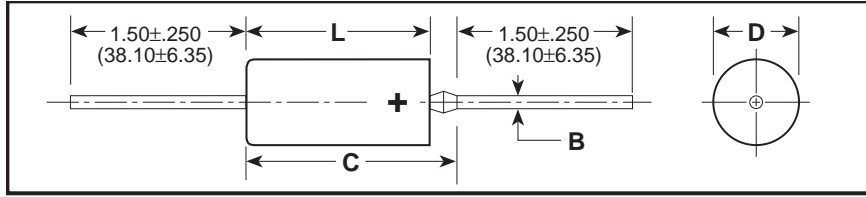

RATINGS & PART NUMBER REFERENCE

CAPACITANCE μF	CASE SIZE	CAPACITANCE TOLERANCE ±%	KEMET T140			MIL-PRF-39003 (CSR23) CAPACITORS											
			KEMET PART NUMBER	D.C. LEAKAGE μA@25°C MAX.	MAX. DISSIPATION FACTOR %@25°C, 120Hz	DASH NUMBER REFERENCE FAILURE RATE LEVEL (%/1000 HRS.)											
						MIL-PRF-39003/3F EXPONENTIAL				MIL-PRF-39003/3I GRADED							
						M (1.0)	P (0.1)	R (0.01)	S (0.001)	B (0.1)	C (0.01)	I (0.001)					
6 VOLT RATING AT 85°C — 4 VOLT RATING AT 125°C																	
8.2	A	10, 20	T140A825(1)006AS	0.9	6												
10.0	A	10	T140A106K006AS	0.9	6	0101	0201	0301	0401	2001	3001	4001					
10.0	A	20	T140A106M006AS	0.9	6	0102	0202	0302	0402	2002	3002	4002					
12.0	A	10	T140A126K006AS	1.0	6	0103	0203	0303	0403	2003	3003	4003					
12.0	A	20	T140A126M006AS	1.0	6												
68.0	B	10, 20	T140B686(1)006AS	3.0	6												
82.0	B	10, 20	T140B826(1)006AS	3.0	6												
100.0	B	10	T140B107K006AS	6.0	6	0104	0204	0304	0404	2004	3004	4004					
100.0	B	20	T140B107M006AS	6.0	6	0105	0205	0305	0405	2005	3005	4005					
220.0	C	10, 20	T140C227(1)006AS	10.0	8												
270.0	C	10, 20	T140C277(1)006AS	10.0	8												
330.0	C	10	T140C337K006AS	10.0	8	0106	0206	0306	0406	2006	3006	4006					
330.0	C	20	T140C337M006AS	10.0	8	0107	0207	0307	0407	2007	3007	4007					
390.0	C	10	T140C397K006AS	10.0	10	0108	0208	0308	0408	2008	3008	4008					
390.0	C	20	T140C397M006AS	10.0	10												
470.0	C	10	T140C477K006AS	10.0	10	0109	0209	0309	0409	2009	3009	4009					
470.0	C	20	T140C477M006AS	10.0	10	0110	0210	0310	0410	2010	3010	4010					
560.0	D	10, 20	T140D567(1)006AS	20.0	10												
680.0	D	10	T140D687K006AS	20.0	10	0111	0211	0311	0411	2011	3011	4011					
680.0	D	20	T140D687M006AS	20.0	10	0112	0212	0312	0412	2012	3012	4012					
820.0	D	10	T140D827K006AS	20.0	10	0113	0213	0313	0413	2013	3013	4013					
820.0	D	20	T140D827M006AS	20.0	10												
1000.0	D	10	T140D108K006AS	20.0	10	0114	0214	0314	0414	2014	3014	4014					
1000.0	D	20	T140D108M006AS	20.0	10	0115	0215	0315	0415	2015	3015	4015					
1200.0	D	20	T140D128M006AS	20.0	10												

(1) To complete T140 Series Part Number, insert Capacitance Tolerance Symbol in the 9th Character as shown on Page 6.
(2) To complete the T242 Series Part Number, insert Failure Rate Symbol in the 13th Character.
Bold Face lines indicate popular part types and values.
For ordering information, see page 4 (Military) and Page 6.

8.2	A	10	T140A825K010AS	1.2	6	0118	0218	0318	0418	2018	3018	4018
8.2	A	20	T140A825M010AS	1.2	6							
47.0	B	10	T140B476K010AS	4.0	6	0119	0219	0319	0419	2019	3019	4019
47.0	B	20	T140B476M010AS	4.0	6	0120	0220	0320	0420	2020	3020	4020
56.0	B	10	T140B566K010AS	5.0	6	0121	0221	0321	0421	2021	3021	4021
56.0	B	20	T140B566M010AS	5.0	6							
68.0	B	10	T140B686K010AS	6.0	6	0122	0222	0322	0422	2022	3022	4022
68.0	B	20	T140B686M010AS	6.0	6	0123	0223	0323	0423	2023	3023	4023
82.0	B	10	T140B826K010AS	7.0	6	0124	0224	0324	0424	2024	3024	4024
82.0	B	20	T140B826M010AS	7.0	6							
150.0	C	10, 20	T140C157(1)010AS	8.0	8							
180.0	C	10, 20	T140C187(1)010AS	8.0	8							
220.0	C	10	T140C227K010AS	12.0	8	0125	0225	0325	0425	2025	3025	4025
220.0	C	20	T140C227M010AS	12.0	8	0126	0226	0326	0426	2026	3026	4026
270.0	C	10	T140C277K010AS	13.0	8	0127	0227	0327	0427	2027	3027	4027
270.0	C	20	T140C277M010AS	13.0	8							
330.0	D	10, 20	T140D337(1)010AS	16.0	8							
390.0	D	10	T140D397K010AS	16.0	10	0128	0228	0328	0428	2028	3028	4028
390.0	D	20	T140D397M010AS	16.0	10							
470.0	D	10	T140D477K010AS	16.0	10	0129	0229	0329	0429	2029	3029	4029
470.0	D	20	T140D477M010AS	16.0	10	0130	0230	0330	0430	2030	3030	4030
560.0	D	10	T140D567K010AS	20.0	10	0131	0231	0331	0431	2031	3031	4031
560.0	D	20	T140D567M010AS	20.0	10							
15 VOLT RATING AT 85°C — 10 VOLT RATING AT 125°C												
3.9	A	10, 20	T140A395(1)015AS	1.0	4							
4.7	A	10	T140A475K015AS	1.0	4	0132	0232	0332	0432	2032	3032	4032
4.7	A	20	T140A475M015AS	1.0	4	0133	0233	0333	0433	2033	3033	4033
5.6	A	10	T140A565K015AS	1.3	4	0134	0234	0334	0434	2034	3034	4034
5.6	A	20	T140A565M015AS	1.3	4							
27.0	B	10, 20	T140B276(1)015AS	3.0	6							
33.0	B	10	T140B336K015AS	5.0	6	0135	0235	0335	0435	2035	3035	4035
33.0	B	20	T140B336M015AS	5.0	6	0136	0236	0336	0436	2036	3036	4036
39.0	B	10	T140B396K015AS	5.3	6	0137	0237	0337	0437	2037	3037	4037
39.0	B	20	T140B396M015AS	5.3	6							
82.0	C	10, 20	T140C826(1)015AS	8.0	6							
100.0	C	10, 20	T140C107(1)015AS	10.0	6							
120.0	C	10, 20	T140C127(1)015AS	10.0	6							
150.0	C	10	T140C157K015AS	15.0	8	0138	0238	0338	0438	2038	3038	4038
150.0	C	20	T140C157M015AS	15.0	8	0139	0239	0339	0439	2039	3039	4039
180.0	C	10	T140C187K015AS	15.0	8	0140	0240	0340	0440	2040	3040	4040
180.0	C	20	T140C187M015AS	15.0	8							
220.0	D	10	T140D227K015AS	20.0	8	0141	0241	0341	0441	2041	3041	4041
220.0	D	20	T140D227M015AS	20.0	8	0142	0242	0342	0442	2042	3042	4042
270.0	D	10	T140D277K015AS	20.0	8	0143	0243	0343	0443	2043	3043	4043
270.0	D	20	T140D277M015AS	20.0	8							
330.0	D	10	T140D337K015AS	20.0	8	0144	0244	0344	0444	2044	3044	4044
330.0	D	20	T140D337M015AS	20.0	8	0145	0245	0345	0445	2045	3045	4045

- (1) To complete T140 Series Part Number, insert Capacitance Tolerance Symbol in the 9th Character as shown on Page 6.
(2) To complete the T242 Series Part Number, insert Failure Rate Symbol in the 13th Character.

3.3	A	20	T140A335M020AS	1.0	4	0148	0248	0348	0448	2048	3048	4048
3.9	A	10	T140A395K020AS	1.2	4	0149	0249	0349	0449	2049	3049	4049
3.9	A	20	T140A395M020AS	1.2	4							
18.0	B	10	T140B186K020AS	3.0	6	0150	0250	0350	0450	2050	3050	4050
18.0	B	20	T140B186M020AS	3.0	6							
22.0	B	10	T140B226K020AS	3.0	6	0151	0251	0351	0451	2051	3051	4051
22.0	B	20	T140B226M020AS	3.0	6	0152	0252	0352	0452	2052	3052	4052
27.0	B	10	T140B276K020AS	4.0	6	0153	0253	0353	0453	2053	3053	4053
27.0	B	20	T140B276M020AS	4.0	6							
56.0	C	10	T140C566K020AS	7.0	6	0154	0254	0354	0454	2054	3054	4054
56.0	C	20	T140C566M020AS	7.0	6							
68.0	C	10	T140C686K020AS	8.0	6	0155	0255	0355	0455	2055	3055	4055
68.0	C	20	T140C686M020AS	8.0	6	0156	0256	0356	0456	2056	3056	4056
82.0	C	10	T140C826K020AS	10.0	6	0157	0257	0357	0457	2057	3057	4057
82.0	C	20	T140C826M020AS	10.0	6							
100.0	C	10	T140C107K020AS	12.0	6	0158	0258	0358	0458	2058	3058	4058
100.0	C	20	T140C107M020AS	12.0	6	0159	0259	0359	0459	2059	3059	4059
120.0	C	10	T140C127K020AS	12.0	6	0160	0260	0360	0460	2060	3060	4060
120.0	C	20	T140C127M020AS	12.0	6							
150.0	D	10	T140D157K020AS	15.0	8	0161	0261	0361	0461	2061	3061	4061
150.0	D	20	T140D157M020AS	15.0	8	0162	0262	0362	0462	2062	3062	4062
180.0	D	10	T140D187K020AS	15.0	8	0163	0263	0363	0463	2063	3063	4063
180.0	D	20	T140D187M020AS	15.0	8							
30 VOLT RATING AT 85°C — 20 VOLT RATING AT 125°C												
1.2	A	10, 20	T140A125(1)030AS	1.0	4							
1.5	A	10, 20	T140A155(1)030AS	1.0	4							
1.8	A	10, 20	T140A185(1)030AS	1.0	4							
2.2	A	10, 20	T140A225(1)030AS	1.0	4							
2.7	A	10, 20	T140A275(1)030AS	1.0	4							
12.0	B	10, 20	T140B126(1)030AS	3.0	4							
15.0	B	10, 20	T140B156(1)030AS	3.0	4							
18.0	B	10, 20	T140B186(1)030AS	3.0	4							
33.0	C	10, 20	T140C336(1)030AS	6.0	6							
39.0	C	10, 20	T140C396(1)030AS	6.0	6							
47.0	C	10, 20	T140C476(1)030AS	7.0	6							
56.0	C	10, 20	T140C566(1)030AS	7.0	6							
68.0	C	10, 20	T140C686(1)030AS	7.0	6							
82.0	D	10, 20	T140D826(1)030AS	10.0	6							
100.0	D	10, 20	T140D107(1)030AS	10.0	8							

(1) To complete T140 Series Part Number, insert Capacitance Tolerance Symbol in the 9th Character as shown on Page 6.

(2) To complete the T242 Series Part Number, insert Failure Rate Symbol in the 13th Character.

Bold Face lines indicate popular part types and values.

1.8	A	20	T140A185M035AS	1.0	4												
8.2	B	10	T140B825K035AS	3.0	4	0165	0265	0365	0465	2065	3065	4065					
8.2	B	20	T140B825M035AS	3.0	4												
10.0	B	10	T140B106K035AS	3.0	4	0166	0266	0366	0466	2066	3066	4066					
10.0	B	20	T140B106M035AS	3.0	4	0167	0267	0367	0467	2067	3067	4067					
27.0	C	10, 20	T140C276(1)035AS	7.0	6												
33.0	C	10	T140C336K035AS	8.0	6	0168	0268	0368	0468	2068	3068	4068					
33.0	C	20	T140C336M035AS	8.0	6	0169	0269	0369	0469	2069	3069	4069					
39.0	C	10	T140C396K035AS	10.0	6	0170	0270	0370	0470	2070	3070	4070					
39.0	C	20	T140C396M035AS	10.0	6												
47.0	C	10	T140C476K035AS	10.0	6	0171	0271	0371	0471	2071	3071	4071					
47.0	C	20	T140C476M035AS	10.0	6	0172	0272	0372	0472	2072	3072	4072					
56.0	D	10	T140D566K035AS	12.0	6	0173	0273	0373	0473	2073	3073	4073					
56.0	D	20	T140D566M035AS	12.0	6												
68.0	D	10	T140D686K035AS	12.0	6	0174	0274	0374	0474	2074	3074	4074					
68.0	D	20	T140D686M035AS	12.0	6	0175	0275	0375	0475	2075	3075	4075					
82.0	D	10, 20	T140D826(1)035AS	20.0	8												
100.0	D	10, 20	T140D107(1)035AS	20.0	8												
50 VOLT RATING AT 85°C — 33 VOLT RATING AT 125°C																	
1.2	A	10	T140A125K050AS	0.6	4	0176	0276	0376	0476	2076	3076	4076					
1.2	A	20	T140A125M050AS	0.6	4												
1.5	A	10	T140A155K050AS	0.8	4	0177	0277	0377	0477	2077	3077	4077					
1.5	A	20	T140A155M050AS	0.8	4	0178	0278	0378	0478	2078	3078	4078					
5.6	B	10	T140B565K050AS	2.5	4	0179	0279	0379	0479	2079	3079	4079					
5.6	B	20	T140B565M050AS	2.5	4												
6.8	B	10	T140B685K050AS	2.5	4	0180	0280	0380	0480	2080	3080	4080					
6.8	B	20	T140B685M050AS	2.5	4	0181	0281	0381	0481	2081	3081	4081					
22.0	C	10	T140C226K050AS	7.0	6	0182	0282	0382	0482	2082	3082	4082					
22.0	C	20	T140C226M050AS	7.0	6	0183	0283	0383	0483	2083	3083	4083					
27.0	C	10	T140C276K050AS	8.0	6	0184	0284	0384	0484	2084	3084	4084					
27.0	C	20	T140C276M050AS	8.0	6												
33.0	D	10	T140D336K050AS	10.0	6	0185	0285	0385	0485	2085	*	:					
33.0	D	20	T140D336M050AS	10.0	6	0186	0286	0386	0486	2086	*	:					
39.0	D	10	T140D396K050AS	10.0	6	0187	0287	0387	0487	2087	*	:					
39.0	D	20	T140D396M050AS	10.0	6												
47.0	D	20	T140D476M050AS	10.0	6												
60 VOLT RATING AT 85°C — 40 VOLT RATING AT 125°C																	
0.82	A	10, 20	T140A824(1)060AS	0.5	4												
1.0	A	10, 20	T140A105(1)060AS	0.5	4												
4.7	B	10, 20	T140B475(1)060AS	3.0	4												
5.6	B	10, 20	T140B565(1)060AS	3.0	4												
15.0	C	10, 20	T140C156(1)060AS	5.0	6												
18.0	C	10, 20	T140C186(1)060AS	6.0	6												
22.0	C	10, 20	T140C226(1)060AS	7.0	6												
27.0	D	10, 20	T140D276(1)060AS	10.0	6												
33.0	D	10, 20	T140D336(1)060AS	10.0	6												

(1) To complete T140 Series Part Number, insert Capacitance Tolerance Symbol in the 9th Character as shown on Page 6.

(2) To complete the T242 Series Part Number, insert Failure Rate Symbol in the 13th Character.

*Note: C Failure Rate not QPL for -3085 thru 3087

D Failure Rate not QPL for -4085 thru 4087

Bold Face lines indicate popular part types and values.

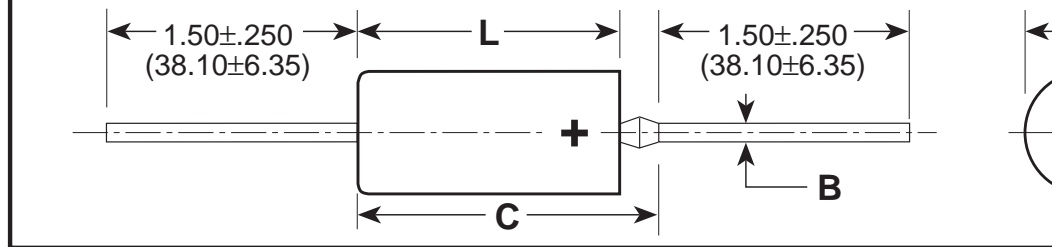

DIMENSIONS — INCHES & (MILLIMETERS)

CASE SIZE	UNINSULATED		INSULATED		B ±0.002 (±.05)
	D ±0.005 (±.13)	L ±0.031 (±.79)	D ±0.010 (±.25)	L ±0.031 (±.79)	
A	0.125 (3.18)	0.250 (6.35)	0.135 (3.43)	0.286 (7.26)	0.020 (.51)
B	0.175 (4.45)	0.438 (11.13)	0.185 (4.70)	0.474 (12.04)	0.020 (.51)
C	0.279 (7.09)	0.650 (16.51)	0.289 (7.34)	0.686 (17.42)	0.025 (.64)
D	0.341 (8.66)	0.750 (19.05)	0.351 (8.92)	0.786 (19.96)	0.025 (.64)

ORDERING INFORMATION

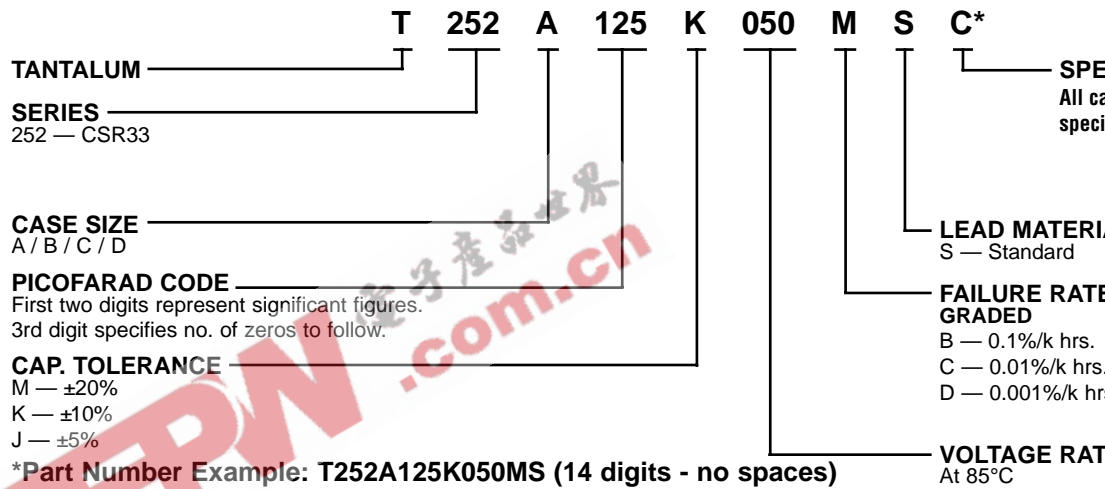

For Military Marking Information, see page 4.

100.0	B	10	1.0	8	0004	0104	0204	0304	2004	3004	4004
100.0	B	20	1.0	8	0005	0105	0205	0305	2005	3005	4005
330.0	C	10	2.0	8	0006	0106	0206	0306	2006	3006	4006
330.0	C	20	2.0	8	0007	0107	0207	0307	2007	3007	4007
390.0	C	10	2.0	10	0008	0108	0208	0308	2008	3008	4008
470.0	C	10	2.0	10	0009	0109	0209	0309	2009	3009	4009
470.0	C	20	2.0	10	0010	0110	0210	0310	2010	3010	4010
680.0	D	10	5.0	10	0011	0111	0211	0311	2011	3011	4011
680.0	D	20	5.0	10	0012	0112	0212	0312	2012	3012	4012
820.0	D	10	5.0	10	0013	0113	0213	0313	2013	3013	4013
1000.0	D	10	5.0	10	0014	0114	0214	0314	2014	3014	4014
1000.0	D	20	5.0	10	0015	0115	0215	0315	2015	3015	4015
10 VOLT RATING AT 85°C											
6.8	A	10	.5	6	0016	0116	0216	0316	2016	3016	4016
6.8	A	20	.5	6	0017	0117	0217	0317	2017	3017	4017
8.2	A	10	.5	6	0018	0118	0218	0318	2018	3018	4018
47.0	B	10	1.0	6	0019	0119	0219	0319	2019	3019	4019
47.0	B	20	1.0	6	0020	0120	0220	0320	2020	3020	4020
56.0	B	10	1.0	6	0021	0121	0221	0321	2021	3021	4021
68.0	B	10	1.0	6	0022	0122	0222	0322	2022	3022	4022
68.0	B	20	1.0	6	0023	0123	0223	0323	2023	3023	4023
82.0	B	10	1.0	6	0024	0124	0224	0324	2024	3024	4024
220.0	C	10	1.0	8	0025	0125	0225	0325	2025	3025	4025
220.0	C	20	1.0	8	0026	0126	0226	0326	2026	3026	4026
270.0	C	10	2.0	8	0027	0127	0227	0327	2027	3027	4027
390.0	D	10	2.0	10	0028	0128	0228	0328	2028	3028	4028
470.0	D	10	4.0	10	0029	0129	0229	0329	2029	3029	4029
470.0	D	20	4.0	10	0030	0130	0230	0330	2030	3030	4030
560.0	D	10	4.0	10	0031	0131	0231	0331	2031	3031	4031
15 VOLT RATING AT 85°C											
4.7	A	10	.5	4	0032	0132	0232	0332	2032	3032	4032
4.7	A	20	.5	4	0033	0133	0233	0333	2033	3033	4033
5.6	A	10	.5	4	0034	0134	0234	0334	2034	3034	4034
33.0	B	10	1.0	6	0035	0135	0235	0335	2035	3035	4035
33.0	B	20	1.0	6	0036	0136	0236	0336	2036	3036	4036
39.0	B	10	1.0	6	0037	0137	0237	0337	2037	3037	4037
150.0	C	10	1.0	8	0038	0138	0238	0338	2038	3038	4038
150.0	C	20	1.0	8	0039	0139	0239	0339	2039	3039	4039
180.0	C	10	2.0	8	0040	0140	0240	0340	2040	3040	4040
220.0	D	10	2.0	8	0041	0141	0241	0341	2041	3041	4041
220.0	D	20	2.0	8	0042	0142	0242	0342	2042	3042	4042
270.0	D	10	2.0	8	0043	0143	0243	0343	2043	3043	4043
330.0	D	10	2.0	8	0044	0144	0244	0344	2044	3044	4044
330.0	D	20	2.0	8	0045	0145	0245	0345	2045	3045	4045

(1) To complete Part Number, insert Failure Rate Symbol in the 13th Character as shown on Page 31.

3.9	A	10	.5	4	0049	0149	0249	0349	2049	3049	4049
18.0	B	10	1.0	6	0050	0150	0250	0350	2050	3050	4050
22.0	B	10	1.0	6	0051	0151	0251	0351	2051	3051	4051
22.0	B	20	1.0	6	0052	0152	0252	0352	2052	3052	4052
27.0	B	10	1.0	6	0053	0153	0253	0353	2053	3053	4053
56.0	C	10	1.0	6	0054	0154	0254	0354	2054	3054	4054
68.0	C	10	1.0	6	0055	0155	0255	0355	2055	3055	4055
68.0	C	20	1.0	6	0056	0156	0256	0356	2056	3056	4056
82.0	C	10	1.0	6	0057	0157	0257	0357	2057	3057	4057
100.0	C	10	1.0	6	0058	0158	0258	0358	2058	3058	4058
100.0	C	20	1.0	6	0059	0159	0259	0359	2059	3059	4059
120.0	C	10	1.0	6	0060	0160	0260	0360	2060	3060	4060
150.0	D	10	2.0	8	0061	0161	0261	0361	2061	3061	4061
150.0	D	20	2.0	8	0062	0162	0262	0362	2062	3062	4062
180.0	D	10	2.0	8	0063	0163	0263	0363	2063	3063	4063
35 VOLT RATING AT 85°C											
1.8	A	10	.5	4	0064	0164	0264	0364	2064	3064	4064
8.2	B	10	1.0	6	0065	0165	0265	0365	2065	3065	4065
10.0	B	10	1.0	6	0066	0166	0266	0366	2066	3066	4066
10.0	B	20	1.0	6	0067	0167	0267	0367	2067	3067	4067
33.0	C	10	1.0	6	0068	0168	0268	0368	2068	3068	4068
33.0	C	20	1.0	6	0069	0169	0269	0369	2069	3069	4069
39.0	C	10	1.0	6	0070	0170	0270	0370	2070	3070	4070
47.0	C	10	1.0	6	0071	0171	0271	0371	2071	3071	4071
47.0	C	20	1.0	6	0072	0172	0272	0372	2072	3072	4072
56.0	D	10	2.0	6	0073	0173	0273	0373	2073	3073	4073
68.0	D	10	2.0	6	0074	0174	0274	0374	2074	3074	4074
68.0	D	20	2.0	6	0075	0175	0275	0375	2075	3075	4075
50 VOLT RATING AT 85°C											
1.2	A	10	.5	4	0076	0176	0276	0376	2076	3076	4076
1.5	A	10	.5	4	0077	0177	0277	0377	2077	3077	4077
1.5	A	20	.5	4	0078	0178	0278	0378	2078	3078	4078
5.6	B	10	1.0	4	0079	0179	0279	0379	2079	3079	4079
6.8	B	10	1.0	6	0080	0180	0280	0380	2080	3080	4080
6.8	B	20	1.0	6	0081	0181	0281	0381	2081	3081	4081
22.0	C	10	1.0	6	0082	0182	0282	0382	2082	3082	4082
22.0	C	20	1.0	6	0083	0183	0283	0383	2083	3083	4083
27.0	C	10	1.0	6	0084	0184	0284	0384	2084	3084	4084
33.0	D	10	1.0	6	0085	0185	0285	0385	2085	*	*
33.0	D	20	1.0	6	0086	0186	0286	0386	2086	*	*
39.0	D	10	1.0	6	0087	0187	0287	0387	2087	*	*

(1) To complete Part Number, insert Failure Rate Symbol in the 13th Character as shown on Page 31.

*NOTE: C Failure rate not QPL for -3085 thru 3087.

D Failure rate not QPL for -4085 thru 4087.

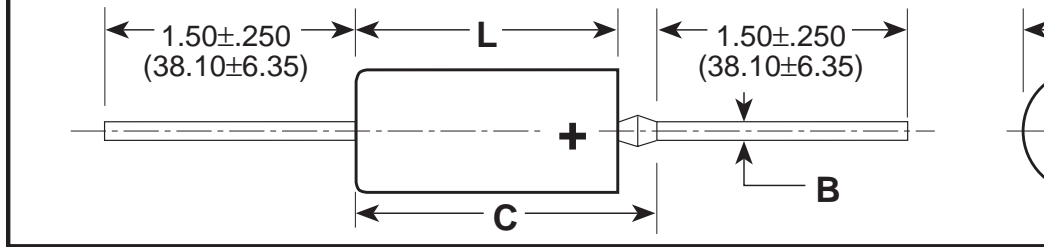

DIMENSIONS — INCHES & (MILLIMETERS)

CASE SIZE	UNINSULATED		INSULATED		B ±0.002 (±.05)
	D ±0.005 (±.13)	L ±0.031 (±.79)	D ±0.010 (±.25)	L ±0.031 (±.79)	
C	0.279 (7.09)	0.650 (16.51)	0.289 (7.34)	0.686 (17.42)	0.025 (.64)
D	0.341 (8.66)	0.750 (19.05)	0.351 (8.92)	0.786 (19.96)	0.025 (.64)

ORDERING INFORMATION

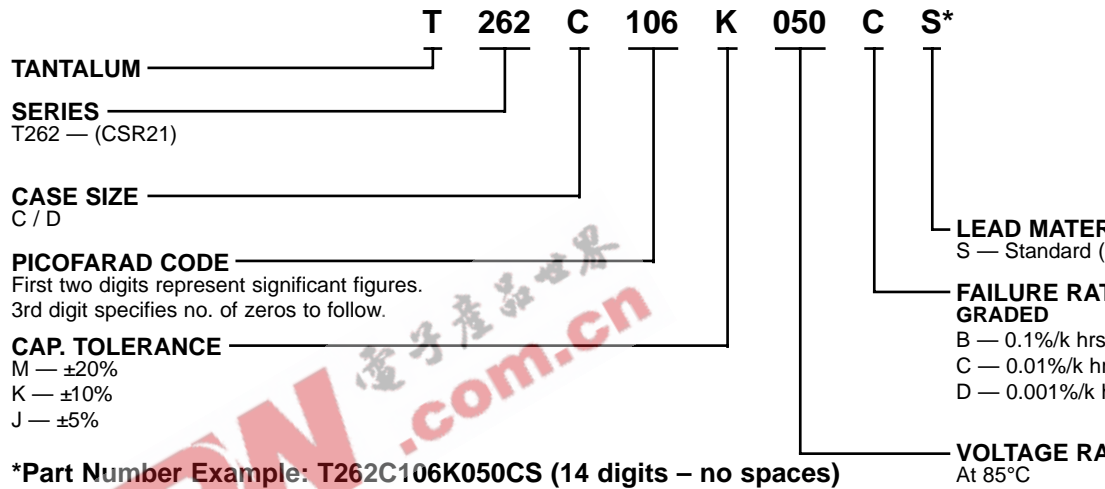

For Military Marking Information, see page 4.

180.0	C	5	5.5	10	.060	3.4	0004	0104	0204	0304	2004	3004	4004
180.0	C	10	5.5	10	.060	3.4	0005	0105	0205	0305	2005	3005	4005
270.0	D	5	6.5	10	.050	4.1	0006	0106	0206	0306	2006	3006	4006
270.0	D	10	6.5	10	.050	4.1	0007	0107	0207	0307	2007	3007	4007
330.0	D	5	7.5	12	.045	4.3	0008	0108	0208	0308	2008	3008	4008
330.0	D	10	7.5	12	.045	4.3	0009	0109	0209	0309	2009	3009	4009
330.0	D	20	7.5	12	.045	4.3	0010	0110	0210	0310	2010	3010	4010
10 VOLT RATING AT 85°C — 7 VOLT RATING AT 125°C													
82.0	C	5	4.0	8	.085	2.9	0011	0111	0211	0311	2011	3011	4011
82.0	C	10	4.0	8	.085	2.9	0012	0112	0212	0312	2012	3012	4012
100.0	C	5	5.0	8	.075	3.0	0013	0113	0213	0313	2013	3013	4013
100.0	C	10	5.0	8	.075	3.0	0014	0114	0214	0314	2014	3014	4014
100.0	C	20	5.0	8	.075	3.0	0015	0115	0215	0315	2015	3015	4015
120.0	C	5	6.0	8	.070	3.2	0016	0116	0216	0316	2016	3016	4016
120.0	C	10	6.0	8	.070	3.2	0017	0117	0217	0317	2017	3017	4017
180.0	D	5	9.0	8	.060	3.7	0018	0118	0218	0318	2018	3018	4018
180.0	D	10	9.0	8	.060	3.7	0019	0119	0219	0319	2019	3019	4019
220.0	D	5	10.0	10	.055	3.9	0020	0120	0220	0320	2020	3020	4020
220.0	D	10	10.0	10	.055	3.9	0021	0121	0221	0321	2021	3021	4021
220.0	D	20	10.0	10	.055	3.9	0022	0122	0222	0322	2022	3022	4022
15 VOLT RATING AT 85°C — 10 VOLT RATING AT 125°C													
56.0	C	5	4.0	6	.100	2.6	0023	0123	0223	0323	2023	3023	4023
56.0	C	10	4.0	6	.100	2.6	0024	0124	0224	0324	2024	3024	4024
68.0	C	5	5.0	6	.095	2.7	0025	0125	0225	0325	2025	3025	4025
68.0	C	10	5.0	6	.095	2.7	0026	0126	0226	0326	2026	3026	4026
68.0	C	20	5.0	6	.095	2.7	0027	0127	0227	0327	2027	3027	4027
120.0	D	5	9.0	8	.070	3.5	0028	0128	0228	0328	2028	3028	4028
120.0	D	10	9.0	8	.070	3.5	0029	0129	0229	0329	2029	3029	4029
150.0	D	5	10.0	8	.065	3.6	0030	0130	0230	0330	2030	3030	4030
150.0	D	10	10.0	8	.065	3.6	0031	0131	0231	0331	2031	3031	4031
150.0	D	20	10.0	8	.065	3.6	0032	0132	0232	0332	2032	3032	4032
20 VOLT RATING AT 85°C — 13 VOLT RATING AT 125°C													
27.0	C	5	2.5	5	.145	2.2	0033	0133	0233	0333	2033	3033	4033
27.0	C	10	2.5	5	.145	2.2	0034	0134	0234	0334	2034	3034	4034
33.0	C	5	3.5	5	.130	2.3	0035	0135	0235	0335	2035	3035	4035
33.0	C	10	3.5	5	.130	2.3	0036	0136	0236	0336	2036	3036	4036
33.0	C	20	3.5	5	.130	2.3	0037	0137	0237	0337	2037	3037	4037
39.0	C	5	4.0	5	.120	2.4	0038	0138	0238	0338	2038	3038	4038
39.0	C	10	4.0	5	.120	2.4	0039	0139	0239	0339	2039	3039	4039
47.0	C	5	4.5	6	.110	2.5	0040	0140	0240	0340	2040	3040	4040
47.0	C	10	4.5	6	.110	2.5	0041	0141	0241	0341	2041	3041	4041
47.0	C	20	4.5	6	.110	2.5	0042	0142	0242	0342	2042	3042	4042
56.0	D	5	5.5	6	.100	2.9	0043	0143	0243	0343	2043	3043	4043
56.0	D	10	5.5	6	.100	2.9	0044	0144	0244	0344	2044	3044	4044
68.0	D	5	7.0	6	.095	3.0	0045	0145	0245	0345	2045	3045	4045
68.0	D	10	7.0	6	.095	3.0	0046	0146	0246	0346	2046	3046	4046
68.0	D	20	7.0	6	.095	3.0	0047	0147	0247	0347	2047	3047	4047
82.0	D	5	8.0	6	.085	3.1	0048	0148	0248	0348	2048	3048	4048
82.0	D	10	8.0	6	.085	3.1	0049	0149	0249	0349	2049	3049	4049
100.0	D	5	10.0	8	.075	3.3	0050	0150	0250	0350	2050	3050	4050
100.0	D	10	10.0	8	.075	3.3	0051	0151	0251	0351	2051	3051	4051
100.0	D	20	10.0	8	.075	3.3	0052	0152	0252	0352	2052	3052	4052

(1) To complete the T262 Series Part Number, insert Failure Rate Symbol in the 13th Character as shown on Page 34.

27.0	D	5	4.5	4	.145	2.4	0056	0156	0256	0356	2056	3056	4
27.0	D	10	4.5	4	.145	2.4	0057	0157	0257	0357	2057	3057	4
33.0	D	5	5.5	5	.130	2.5	0058	0158	0258	0358	2058	3058	4
33.0	D	10	5.5	5	.130	2.5	0059	0159	0259	0359	2059	3059	4
33.0	D	20	5.5	5	.130	2.5	0060	0160	0260	0360	2060	3060	4
39.0	D	5	7.0	5	.120	2.6	0061	0161	0261	0361	2061	3061	4
39.0	D	10	7.0	5	.120	2.6	0062	0162	0262	0362	2062	3062	4
47.0	D	5	8.0	5	.110	2.7	0063	0163	0263	0363	2063	3063	4
47.0	D	10	8.0	5	.110	2.7	0064	0164	0264	0364	2064	3064	4
47.0	D	20	8.0	5	.110	2.7	0065	0165	0265	0365	2065	3065	4

50 VOLT RATING AT 85°C — 33 VOLT RATING AT 125°C

5.6	C	5	2.2	3	.300	1.5	0066	0166	0266	0366	2066	3066	4
5.6	C	10	2.2	3	.300	1.5	0067	0167	0267	0367	2067	3067	4
6.8	C	5	2.2	3	.275	1.6	0068	0168	0268	0368	2068	3068	4
6.8	C	10	2.2	3	.275	1.6	0069	0169	0269	0369	2069	3069	4
6.8	C	20	2.2	3	.275	1.6	0070	0170	0270	0370	2070	3070	4
8.2	C	5	2.5	3	.250	1.6	0071	0171	0271	0371	2071	3071	4
8.2	C	10	2.5	3	.250	1.6	0072	0172	0272	0372	2072	3072	4
10.0	C	5	2.5	3	.230	1.7	0073	0173	0273	0373	2073	3073	4
10.0	C	10	2.5	3	.230	1.7	0074	0174	0274	0374	2074	3074	4
10.0	C	20	2.5	3	.230	1.7	0075	0175	0275	0375	2075	3075	4
12.0	C	5	3.0	3	.210	1.8	0076	0176	0276	0376	2076	3076	4
12.0	C	10	3.0	3	.210	1.8	0077	0177	0277	0377	2077	3077	4
15.0	C	5	4.0	3	.190	1.9	0078	0178	0278	0378	2078	3078	4
15.0	C	10	4.0	3	.190	1.9	0079	0179	0279	0379	2079	3079	4
15.0	C	20	4.0	3	.190	1.9	0080	0180	0280	0380	2080	3080	4
18.0	C	5	4.5	4	.175	2.0	0081	0181	0281	0381	2081	3081	4
18.0	C	10	4.5	4	.175	2.0	0082	0182	0282	0382	2082	3082	4
22.0	D	5	5.5	4	.160	2.3	0083	0183	0283	0383	2083	3083	4
22.0	D	10	5.5	4	.160	2.3	0084	0184	0284	0384	2084	3084	4
22.0	D	20	5.5	4	.160	2.3	0085	0185	0285	0385	2085	3085	4

(1) To complete the T262 Series Part Number, insert Failure Rate Symbol in the 13th Character as shown on Page 34.



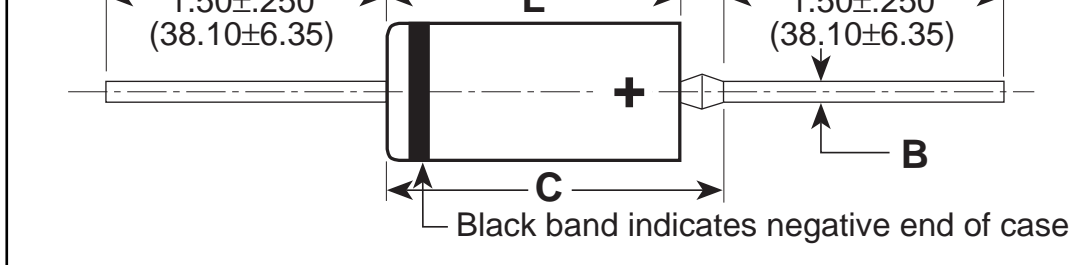

DIMENSIONS — INCHES & (MILLIMETERS)

CASE SIZE	UNINSULATED		INSULATED		B ±0.002 (±.05)
	D ±0.005 (±.13)	L ±0.031 (±.79)	D ±0.010 (±.25)	L ±0.031 (±.79)	
A	0.125 (3.18)	0.250 (6.35)	0.135 (3.43)	0.286 (7.26)	0.020 (.51)
B	0.175 (4.45)	0.438 (11.13)	0.185 (4.70)	0.474 (12.04)	0.020 (.51)
C	0.279 (7.09)	0.650 (16.51)	0.289 (7.34)	0.686 (17.42)	0.025 (.64)
D	0.341 (8.66)	0.750 (19.05)	0.351 (8.92)	0.786 (19.96)	0.025 (.64)

ORDERING INFORMATION

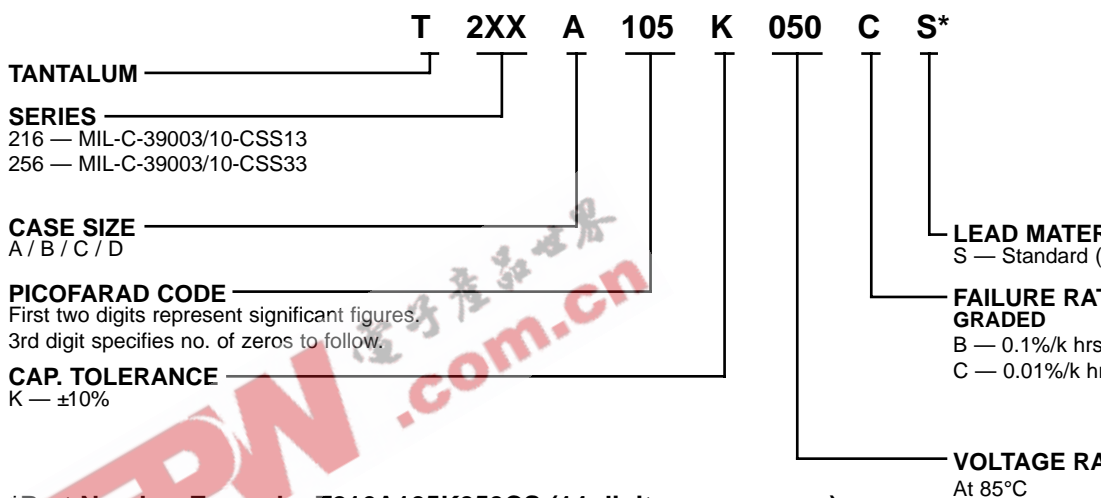

*Part Number Example: T216A105K050CS (14 digits – no spaces)

MARKING INFORMATION

A CASE

39003	— Military specification number
10 - K	— Specification sheet number and trademark
3078S	— Military dash number and "S" for sleeved
+J910	— Polarity, "J" for JAN date code (1st digit indicates year and the next two digits indicate the week)
XYA	— Lot, unique lot code

C & D CASE

M39003	— Military specification number
10-2049SJ	— Specification sheet number and "J" for Jan.
+6.8 μ F	— Positive terminal identifier
10% 35V	— Capacitance tolerance
31433	— Source code
9910 NAB K	— Date code, lot code, and trademark

B CASE

M39003	— Military specification number
10 -	— Specification sheet number
3082SJ	— Military dash number and "J" for JAN
31433	— Source code
+910	— Polarity, date code (1st digit indicates year and the next two digits indicate the week)
NABK	— Lot code, unique lot code and trademark.

NOTE: Marking will include S or U after third letter following lot symbol or lot code identifier, and a black band on negative end.

■ Black band on negative end.

T216/(CSS13) RATINGS & PART NUMBER REFERENCE

KEMET T216								
CAPACITANCE μ F	CASE SIZE	KEMET EQUIVALENT PART NUMBER FOR CSS13 CAPACITORS	DC LEAKAGE			MAX. DISSIPATION FACTOR		MAX. ESR Ω @ 25°C 100kHz
			μ A @ +25° MAX.	μ A @ +85° MAX.	μ A @ +125° MAX.	% @ -55°C +25°C MAX.	% @ -85°C +125°C MAX.	
6 VOLT RATING AT 85°C								
5.6	A	T216A565K006CS	.3	6.0	7.5	4	4	.90
6.8	A	T216A685K006CS	.3	6.0	7..5	6	6	.80
47.0	B	T216B476K006CS	1.5	24.0	30.0	6	6	.24
56.0	B	T216B566K006CS	1.5	24.0	30.0	6	6	.24
150.0	C	T216C157K006CS	4.5	90.0	113.0	8	8	.09
180.0	C	T216C187K006CS	5.5	110.0	138.0	8	8	.08
270.0	D	T216D277K006CS	6.5	130.0	163.0	8	8	.07
330.0	D	T216D337K006CS	7.5	150.0	188.0	8	8	.06
10 VOLT RATING AT 85°C								
3.9	A	T216A395K010CS	.3	6.0	7.5	4	4	1.00
4.7	A	T216A475K010CS	.4	7.0	8.8	4	4	.90
27.0	B	T216B276K010CS	2.0	40.0	50.0	6	6	.25
33.0	B	T216B336K010CS	2.5	50.0	63.0	6	6	.24
39.0	B	T216B396K010CS	2.5	50.0	63.0	6	6	.24
82.0	C	T216C826K010CS	4.0	80.0	100.0	6	6	.12
100.0	C	T216C107K010CS	5.0	100.0	125.0	8	8	.11
120.0	C	T216C127K010CS	6.0	120.0	150.0	8	8	.10
180.0	D	T216D187K010CS	9.0	180.0	226.0	8	8	.08
220.0	D	T216D227K010CS	10.0	200.0	250.0	8	8	.07

(1) To complete, insert S for sleeved or U for unsleeved, if "U" ordered also use C-0100.

56.0	C	T216C566K015CS	4.0	80.0	100.0	6	6	.15
68.0	C	T216C686K015CS	5.0	100.0	125.0	6	6	.13
120.0	D	T216D127K015CS	9.0	180.0	226.0	8	8	.09
150.0	D	T216D157K015CS	10.0	220.0	250.0	8	8	.09
20 VOLT RATING AT 85°C								
1.2	A	T216A125K020CS	.3	6.0	7.5	4	4	1.40
1.5	A	T216A155K020CS	.3	6.0	7.5	4	4	1.30
1.8	A	T216A185K020CS	.3	6.0	7.5	4	4	1.25
2.2	A	T216A225K020CS	.4	8.0	10.0	4	4	1.20
8.2	B	T216B825K020CS	1.0	20.0	25.0	6	6	.39
10.0	B	T216B106K020CS	1.5	30.0	38.0	6	6	.35
12.0	B	T216B126K020CS	1.8	35.0	44.0	6	6	.32
15.0	B	T216B156K020CS	2.0	40.0	50.0	6	6	.29
27.0	C	T216C276K020CS	2.5	50.0	63.0	6	6	.21
33.0	C	T216C336K020CS	3.5	70.0	88.0	6	6	.19
39.0	C	T216C396K020CS	4.0	80.0	100.0	6	6	.17
47.0	C	T216C476K020CS	4.5	90.0	113.0	6	6	.16
56.0	D	T216D566K020BS	5.5	110.0	138.0	6	6	.13
68.0	D	T216D686K020BS	7.0	140.0	175.0	6	6	.12
82.0	D	T216D826K020BS	8.0	160.0	200.0	6	6	.11
100.0	D	T216D107K020BS	10.0	200.0	250.0	8	8	.10
35 VOLT RATING AT 85°C								
5.6	B	T216B565K035BS	1.3	25.0	32.0	4	4	.47
6.8	B	T216B685K035BS	1.5	30.0	38.0	6	6	.43
22.0	C	T216C226K035BS	4.0	40.0	100.0	6	6	.25
27.0	D	T216D276K035BS	4.5	90.0	113.0	6	6	.18
33.0	D	T216D336K035BS	5.5	110.0	138.0	6	6	.17
39.0	D	T216D396K035BS	7.0	140.0	175.0	6	6	.15
47.0	D	T216D476K035BS	8.0	160.0	200.0	6	6	.14
50 VOLT RATING AT 85°C								
.12	A	T216A124K050CS	.3	5.0	6.3	2	4	6.50
.15	A	T216A154K050CS	.3	5.0	6.3	2	4	5.50
.18	A	T216A184K050CS	.3	5.0	6.3	2	4	5.00
.22	A	T216A224K050CS	.3	5.0	6.3	2	4	4.00
.27	A	T216A274K050CS	.3	5.0	6.3	2	4	3.50
.33	A	T216A334K050CS	.3	5.0	6.3	2	4	3.30
.39	A	T216A394K050CS	.3	5.0	6.3	2	4	3.20
.47	A	T216A474K050CS	.3	5.0	6.3	2	4	3.00
.56	A	T216A564K050CS	.3	5.0	6.3	2	4	2.50
.68	A	T216A684K050CS	.3	5.0	6.3	2	4	1.80
.82	A	T216A824K050CS	.3	5.0	6.3	2	4	1.60
1.0	A	T216A105K050CS	.4	8.0	10.0	2	4	1.40
1.2	B	T216B125K050CS	.4	9.0	11.0	4	4	1.20
1.5	B	T216B155K050CS	.6	12.0	15.0	4	4	1.10
1.8	B	T216B185K050CS	.7	14.0	18.0	4	4	.92
2.2	B	T216B225K050CS	.8	17.0	22.0	4	4	.80
2.7	B	T216B275K050CS	1.0	20.0	25.0	4	4	.68
3.3	B	T216B335K050CS	1.2	25.0	32.0	4	4	.62
3.9	B	T216B395K050CS	1.5	30.0	38.0	4	4	.56
4.7	B	T216B475K050BS	1.7	35.0	44.0	4	4	.51
5.6	C	T216C565K050CS	2.2	45.0	56.0	4	4	.44
6.8	C	T216C685K050CS	2.2	45.0	56.0	6	6	.40
8.2	C	T216C825K050CS	2.5	50.0	63.0	6	6	.36
10.0	C	T216C106K050CS	2.5	50.0	63.0	6	6	.33
12.0	C	T216C126K050BS	3.0	60.0	75.0	6	6	.30
15.0	C	T216C156K020BS	4.0	80.0	100.0	6	6	.27
18.0	C	T216C186K050BS	4.5	90.0	113.0	6	6	.25
22.0	D	T216D226K050BS	5.5	100.0	138.0	6	6	.20

(1) To complete, insert S for sleeved or U for unsleeved, if "U" ordered also use C-0100.

KEMET Electronics Corporation, P.O. Box 5928, Greenville, S.C. 29606 (864) 963-6300

.33	A	T216A334K075CS	.3	5.0	6.3	2	4	2.8
.39	A	T216A394K075CS	.3	5.0	6.3	2	4	2.6
.47	A	T216A474K075CS	.3	5.0	6.3	2	4	2.4
.56	A	T216A564K075CS	.3	5.0	6.3	2	4	2.25
.68	A	T216A684K075CS	.3	5.0	6.3	2	4	2.10
.82	B	T216B824K075CS	.3	5.0	6.3	2	4	1.47
1.0	B	T216B105K075CS	.4	5.0	6.3	2	4	1.40
1.2	B	T216B125K075CS	.4	5.0	6.3	4	4	1.33
1.5	B	T216B155K075CS	.6	10.0	13.0	4	4	1.06
1.8	B	T216B185K075CS	.7	10.0	13.0	4	4	.92
2.2	B	T216B225K075CS	.8	15.0	19.0	4	4	.80
2.7	B	T216B275K075BS	1.0	15.0	19.0	4	4	.68
3.3	B	T216B335K075BS	1.2	20.0	25.0	4	4	.62
3.9	B	T216B395K075BS	1.5	20.0	25.0	4	4	.56
4.7	C	T216C475K075BS	3.0	60.0	75.0	4	4	.47
5.6	C	T216C565K075BS	3.0	60.0	75.0	4	4	.44
6.8	C	T216C685K075BS	5.0	100.0	125.0	6	6	.44
8.2	C	T216C825K075BS	5.0	100.0	125.0	6	6	.36
10.0	C	T216C106K075BS	5.0	100.0	125.0	6	6	.33
12.0	D	T216D126K075BS	5.0	100.0	125.0	6	6	.26
15.0	D	T216D156K075BS	7.0	140.0	175.0	6	6	.23

T256/(CSS33) RATINGS AND PART NUMBER REFERENCE

CAPACITANCE μF	CASE SIZE	KEMET EQUIVALENT PART NUMBER FOR CSS33 CAPACITORS	KEMET T256 SERIES					
			DC LEAKAGE			MAX. DISSIPATION FACTOR		MAX. ESR Ω @ 25°C 100kHz
			μA @ +25° MAX.	μA @ +85° MAX.	μA @ +125° MAX.	% @ -55°C +25°C MAX.	% @ -85°C +125°C MAX.	
6 VOLT RATING AT 85°C								
10.0	A	T256A106K006CS	.5	2.0	2.0	6	6	.70
12.0	A	T256A126K006CS	.5	2.0	2.0	6	6	.60
100.0	B	T256B107K006CS	1.0	3.0	3.0	8	8	.20
330.0	C	T256C337K006BS	2.0	8.0	8.0	8	8	.065
390.0	C	T256C397K006BS	2.0	8.0	8.0	10	10	.065
470.0	C	T256C477K006BS	2.0	8.0	8.0	10	10	.060
680.0	D	T256D687K006CS	5.0	10.0	10.0	10	10	.060
820.0	D	T256D827K006CS	5.0	10.0	10.0	10	10	.055
1000.0	D	T256D108K006CS	5.0	10.0	10.0	10	10	.050
10 VOLT RATING AT 85°C								
6.8	A	T256A685K010CS	.5	2.0	2.0	6	6	.80
8.2	A	T256A825K010CS	.5	2.0	2.0	6	6	.70
47.0	B	T256B476K010CS	1.0	2.0	2.0	6	6	.22
56.0	B	T256B566K010CS	1.0	4.0	4.0	6	6	.20
68.0	B	T256B686K010CS	1.0	4.0	4.0	6	6	.18
82.0	B	T256B826K010CS	1.0	4.0	4.0	6	6	.15
220.0	C	T256C227K010BS	1.0	7.0	7.0	8	8	.090
270.0	C	T256C277K010BS	2.0	10.0	10.0	8	8	.075
390.0	D	T256D397K010CS	2.0	16.0	16.0	10	10	.070
470.0	D	T256D477K010CS	4.0	16.0	16.0	10	10	.065
560.0	D	T256D567K010CS	4.0	16.0	16.0	10	10	.060

(1) To complete, insert S for sleeved or U for unsleeved, if "U" ordered also use C-0100.

150.0	C	T256C157K015BS	1.0	7.0	7.0	8	8	.10
180.0	C	T256C187K015BS	2.0	10.0	10.0	8	8	.09
220.0	D	T256D227K015BS	2.0	10.0	10.0	8	8	.07
270.0	D	T256D277K015BS	2.0	16.0	16.0	8	8	.065
330.0	D	T256D337K015BS	2.0	16.0	16.0	8	8	.060
20 VOLT RATING AT 85°C								
2.7	A	T256A275K020CS	.5	2.0	2.0	4	4	1.15
3.3	A	T256A335K020CS	.5	2.0	2.0	4	4	.95
3.9	A	T256A395K020CS	.5	2.0	2.0	4	4	.90
18.0	B	T256B186K020CS	1.0	2.0	2.0	6	6	.27
22.0	B	T256B226K020BS	1.0	2.0	2.0	6	6	.26
27.0	B	T256B276K020BS	1.0	2.0	2.0	6	6	.24
56.0	C	T256C566K020CS	1.0	10.0	10.0	6	6	.15
68.0	C	T256C686K020CS	1.0	10.0	10.0	6	6	.14
82.0	C	T256C826K020BS	1.0	10.0	10.0	6	6	.12
100.0	C	T256C107K020BS	1.0	10.0	10.0	6	6	.10
120.0	C	T256C127K020BS	1.0	10.0	10.0	6	6	.09
150.0	D	T256D157K020BS	2.0	10.0	10.0	8	8	.08
180.0	D	T256D187K020BS	2.0	10.0	10.0	8	8	.07
35 VOLT RATING AT 85°C								
1.8	A	T256A185K035BS	.5	2.0	2.0	4	4	.20
8.2	B	T256B825K035BS	1.0	2.0	2.0	6	6	.40
10.0	B	T256B106K035BS	1.0	2.0	2.0	6	6	.35
33.0	C	T256C336K035BS	1.0	5.0	5.0	6	6	.19
39.0	C	T256C396K035BS	1.0	5.0	5.0	6	6	.17
47.0	C	T256C476K035BS	1.0	5.0	5.0	6	6	.15
56.0	D	T256D566K035BS	2.0	10.0	10.0	6	6	.13
68.0	D	T256D686K035BS	2.0	10.0	10.0	6	6	.12
50 VOLT RATING AT 85°C								
1.2	A	T256A125K050BS	.5	2.0	2.0	4	4	1.30
1.5	A	T256A155K050BS	.5	2.0	2.0	4	4	1.20
5.6	B	T256B565K050BS	1.0	2.0	2.0	4	4	.47
6.8	B	T256B685K050BS	1.0	2.0	2.0	6	6	.43
22.0	C	T256C226K050BS	1.0	5.0	5.0	6	6	.22
27.0	C	T256C276K050BS	1.0	5.0	5.0	6	6	.20
33.0	D	T256D336K050BS	1.0	9.0	9.0	6	6	.18
39.0	D	T256D396K050BS	1.0	9.0	9.0	6	6	.16

(1) To complete, insert S for sleeved or U for unsleeved, if "U" ordered also use C-0100.

PERFORMANCE CHARACTERISTICS

- **CAPACITANCE/VOLTAGE RANGE:**
0.1-330 μ F, 2-50 Volts.
- **CAPACITANCE TOLERANCE:** Available in standard EIA nominal values with $\pm 20\%$, $\pm 10\%$ and $\pm 5\%$ tolerance.
- **DISSIPATION FACTOR:** Maximum DF limits are shown in corresponding series part number listings on pages 44-48. See Application Notes Section, page 76 for additional description.
- **DC LEAKAGE CURRENT:** Each corresponding part number table lists maximum leakage current for each capacitor on pages 44 through 48. See Application Notes Section, page 76 for additional description.
- **RATED VOLTAGE; WORKING VOLTAGE; SURGE VOLTAGE; REVERSE VOLTAGE:** See Application Notes Section, page 76 & 77 for description.
- **AC RIPPLE VOLTAGE:** Permissible AC ripple voltage is related to equivalent series resistance (ESR) and power dissipation capability. Maximum power dissipation for each case size is listed in Table below. For additional description see page 79.

Case Size	Power Dissipation (max.) @ 25°C (watts)
A	.060
B	.070
C	.080
D	.090
E	.100
F	.110

Maximum Power Dissipation Capability @ 25°C

- **IMPEDANCE and ESR:** See Application Notes Section, pages 77 & 78 for description. Reference ESR values are shown in adjoining column, this page.
- **ENVIRONMENTAL CONSIDERATIONS:**
 - A. Shock Test: MIL-STD-202, Method 213.
 - B. Thermal Shock, MIL-STD-202, Method 107.
 - C. Moisture Resistance: MIL-STD-202, Method 106.
 - D. Solderability: MIL-STD-202, Method 208.

T322 ESR (OHMS) at 100
(The ESR values provided below are for reference only. No warranty, as stated, is made as to the accuracy of these values for any particular

Cap. μ F	6 Volt	10 Volt	15 Volt	20 Volt
0.10				
0.12				
0.15				
0.18				
0.22				
0.27				
0.33				
0.39				
0.47				
0.56				
0.68				
0.82				
1.00				10.0
1.20				10.0
1.50			10.0	9.0
1.80			10.0	9.0
2.20		13.0	8.0	7.0
2.70		13.0	8.0	7.0
3.30	13.0	10.0	6.0	5.5
3.90	13.0	10.0	6.0	5.5
4.70	10.0	8.0	5.0	4.5
5.60	10.0	8.0	5.0	4.5
6.80	8.0	6.0	4.0	3.5
8.20	8.0	6.0	4.0	3.5
10.0	6.0	5.0	3.2	2.9
12.0	6.0	5.0	3.2	2.9
15.0	5.0	3.7	2.5	2.3
18.0	5.0	3.7	2.5	2.3
22.0	3.7	2.7	2.0	1.8
27.0	3.7	2.7	2.0	1.8
33.0	3.0	2.1	1.6	1.4
39.0	3.0	2.1	1.6	1.4
47.0	2.0	1.7	1.3	1.2
56.0	2.0	1.7	1.3	1.2
68.0	1.8	1.3	1.0	0.9
82.0	1.8	1.3	1.0	0.9
100.0	1.6	1.0	0.8	0.8
120.0	1.6	1.0	0.8	0.8
150.0	0.9	0.8	0.6	
180.0	0.9	0.8		
220.0	0.9	0.6		
270.0	0.9			
330.0	0.7			

For additional Environmental pages 80, 81 and 82.

- **LEAD MATERIAL:** Solder coated per MIL-STD-1276.
- **LEAD TAPE and REEL:** See RS-296. See pages 71 and 72 for information.

CASE SIZE	D (MAX)	L (MAX)
A	.095 (2.41)	.260 (6.6)
B	.110 (2.79)	.290 (7.37)
C	.180 (4.57)	.345 (8.76)
D	.180 (4.57)	.420 (10.67)
E	.280 (7.11)	.530 (13.46)
F	.300 (7.62)	.710 (18.03)

T322 & T323 ORDERING INFORMATION

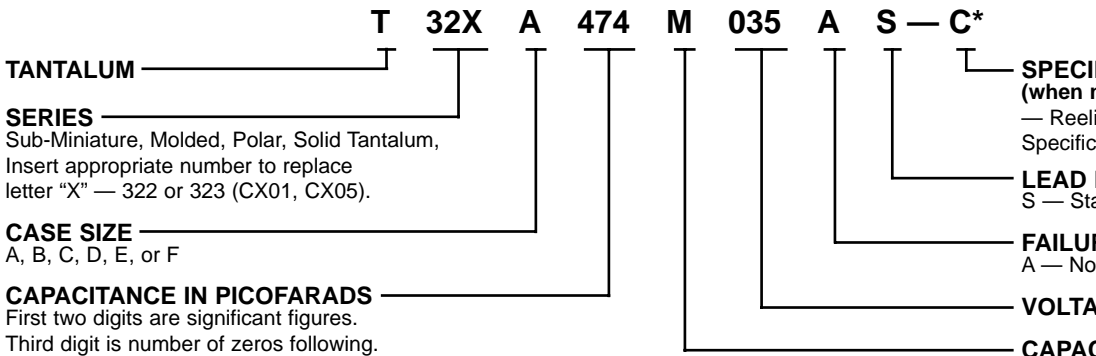

***Part Number Example: T322A474M035AS (14 digits – no spaces)**

MIL-C-49137/5 MILITARY ORDERING INFORMATION

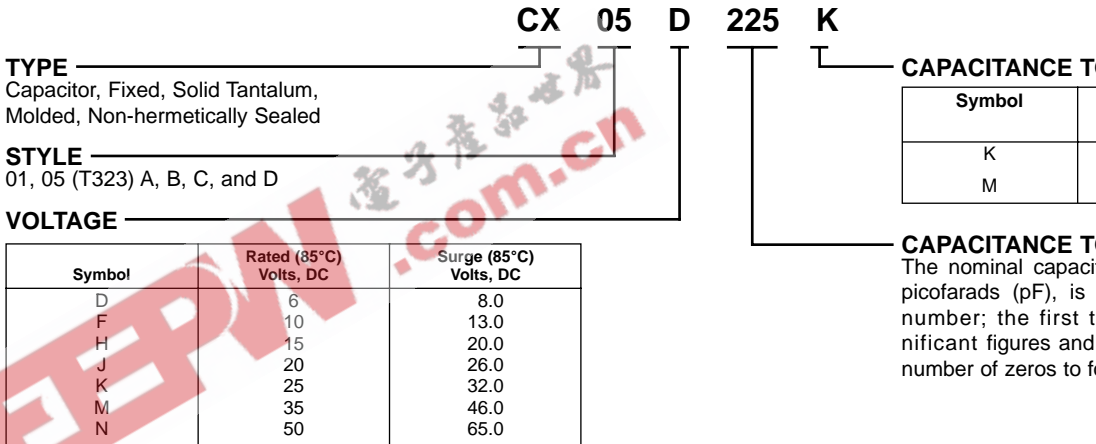

CAPACITOR MARKING

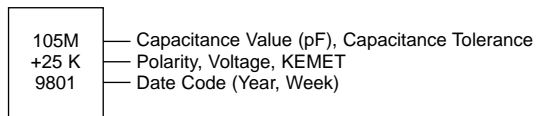

KEMET Electronics Corporation, P.O. Box 5928, Greenville, S.C. 29606 (864) 963-6300

15.0	B	5,10,20	T322B156(1)002AS	0.5	10	
18.0	B	5,10,20	T322B186(1)002AS	0.5	10	
22.0	B	5,10,20	T322B226(1)002AS	0.5	10	
27.0	B	5,10,20	T322B276(1)002AS	0.5	10	
33.0	B	5,10,20	T322B336(1)002AS	0.5	10	
39.0	C	5,10,20	T322C396(1)002AS	0.6	10	
47.0	C	5,10,20	T322C476(1)002AS	0.8	10	
56.0	C	5,10,20	T322C566(1)002AS	0.9	10	
68.0	C	5,10,20	T322C686(1)002AS	1.1	10	
4 VOLT RATING AT 85°C — 2.7 VOLT RATING AT 125°C						
4.7	A	5,10,20	T322A475(1)004AS	0.5	8	
5.6	A	5,10,20	T322A565(1)004AS	0.5	8	
6.8	A	5,10,20	T322A685(1)004AS	0.5	8	
8.2	B	5,10,20	T322B825(1)004AS	0.5	8	
10.0	B	5,10,20	T322B106(1)004AS	0.5	8	
12.0	B	5,10,20	T322B126(1)004AS	0.5	8	
15.0	B	5,10,20	T322B156(1)004AS	0.5	8	
18.0	B	5,10,20	T322B186(1)004AS	0.6	8	
22.0	B	5,10,20	T322B226(1)004AS	0.7	8	
27.0	C	5,10,20	T322C276(1)004AS	0.9	8	
33.0	C	5,10,20	T322C336(1)004AS	1.1	8	
39.0	C	5,10,20	T322C396(1)004AS	1.2	8	
47.0	C	5,10,20	T322C476(1)004AS	1.5	8	
56.0	D	5,10,20	T322D566(1)004AS	1.8	8	
68.0	D	5,10,20	T322D686(1)004AS	2.2	8	
6 VOLT RATING AT 85°C — 4 VOLT RATING AT 125°C						
3.3	A	5,10,20	T322A335(1)006AS	0.5	4	
3.9	A	5,10,20	T322A395(1)006AS	0.5	4	
4.7	A	5	T322A475J006AS	0.5	4	
4.7	A	10	T322A475K006AS	0.5	4	CX05D475K
4.7	A	20	T322A475M006AS	0.5	4	CX05D475M
5.6	B	5	T322B565J006AS	0.5	4	
5.6	B	10	T322B565K006AS	0.5	4	CX01D565K
5.6	B	20	T322B565M006AS	0.5	4	CX01D565M
6.8	B	5	T322B685J006AS	0.5	6	
6.8	B	10	T322B685K006AS	0.5	6	CX01D685K
6.8	B	20	T322B685M006AS	0.5	6	CX01D685M
8.2	B	5	T322B825J006AS	0.5	6	
8.2	B	10	T322B825K006AS	0.5	6	CX01D825K
8.2	B	20	T322B825M006AS	0.5	6	CX01D825M
10.0	B	5	T322B106J006AS	0.5	6	
10.0	B	10	T322B106K006AS	0.5	6	CX01D106K
10.0	B	20	T322B106M006AS	0.5	6	CX01D106M
12.0	B	5	T322B126J006AS	0.6	6	
12.0	B	10	T322B126K006AS	0.6	6	CX01D126K
12.0	B	20	T322B126M006AS	0.6	6	CX01D126M
15.0	B	5	T322B156J006AS	0.7	6	
15.0	B	10	T322B156K006AS	0.7	6	CX05D156K
15.0	B	20	T322B156M006AS	0.7	6	CX05D156M
18.0	C	5,10,20	T322C186(1)006AS	0.9	6	
22.0	C	5,10,20	T322C226(1)006AS	1.1	6	
27.0	C	5,10,20	T322C276(1)006AS	1.3	6	
33.0	C	5	T322C336J006AS	1.5	6	
33.0	C	10	T322C336K006AS	1.5	6	CX05D336K
33.0	C	20	T322C336M006AS	1.5	6	CX05D336M
39.0	D	5,10,20	T322D396(1)006AS	1.9	6	
47.0	D	5	T322D476J006AS	2.3	6	
47.0	D	10	T322D476K006AS	2.3	6	CX05D476K
47.0	D	20	T322D476M006AS	2.3	6	CX05D476M
56.0	D	5,10,20	T322D566(1)006AS	2.7	6	
68.0	D	5,10,20	T322D686(1)006AS	3.3	6	

(1) To complete KEMET Part Number, insert Capacitance Tolerance Symbol as follows: M — ±20%, K — ±10%, J — ±5%
Bold Face lines indicate preferred part types and values.

220.0	E	5,10,20	T322E227(1)006AS	10.0	8	
270.0	F	5,10,20	T322F277(1)006AS	10.0	8	
330.0	F	5,10,20	T322F337(1)006AS	10.0	8	
10 VOLT RATING AT 85°C — 7 VOLT RATING AT 125°C						
2.2	A	5,10,20	T322A225(1)010AS	0.5	4	
2.7	A	5,10,20	T322A275(1)010AS	0.5	4	
3.3	A	5	T322A335J010AS	0.5	4	
3.3	A	10	T322A335K010AS	0.5	4	CX05F335K
3.3	A	20	T322A335M010AS	0.5	4	CX05F335M
3.9	B	5,10,20	T322B395(1)010AS	0.5	4	
4.7	B	5,10,20	T322B475(1)010AS	0.5	4	
5.6	B	5,10,20	T322B565(1)010AS	0.5	4	
6.8	B	5,10,20	T322B685(1)010AS	0.5	6	
8.2	B	5,10,20	T322B825(1)010AS	0.7	6	
10.0	B	5	T322B106J010AS	0.8	6	
10.0	B	10	T322B106K010AS	0.8	6	CX05F106K
10.0	B	20	T322B106M010AS	0.8	6	CX05F106M
12.0	C	5,10,20	T322C126(1)010AS	1.0	6	
15.0	C	5,10,20	T322C156(1)010AS	1.2	6	
18.0	C	5,10,20	T322C186(1)010AS	1.4	6	
22.0	C	5	T322C226J010AS	1.5	6	
22.0	C	10	T322C226K010AS	1.5	6	CX05F226K
22.0	C	20	T322C226M010AS	1.5	6	CX05F226M
27.0	D	5	T322D276J010AS	2.2	6	
27.0	D	10	T322D276K010AS	2.2	6	CX05F276K
27.0	D	20	T322D276M010AS	2.2	6	CX05F276M
33.0	D	5	T322D336J010AS	2.6	6	
33.0	D	10	T322D336K010AS	2.6	6	CX05F336K
33.0	D	20	T322D336M010AS	2.6	6	CX05F336M
39.0	D	5	T322D396J010AS	3.1	6	
39.0	D	10	T322D396K010AS	3.1	6	CX05F396K
39.0	D	20	T322D396M010AS	3.1	6	CX05F396M
47.0	D	5	T322D476J010AS	3.8	6	
47.0	D	10	T322D476K010AS	3.8	6	CX05F476K
47.0	D	20	T322D476M010AS	3.8	6	CX05F476M
56.0	E	5,10,20	T322E566(1)010AS	4.4	6	
68.0	E	5,10,20	T322E686(1)010AS	5.0	6	
82.0	E	5,10,20	T322E826(1)010AS	5.0	8	
100.0	E	5,10,20	T322E107(1)010AS	8.0	8	
120.0	E	5,10,20	T322E127(1)010AS	9.6	8	
150.0	E	5,10,20	T322E157(1)010AS	10.0	8	
180.0	F	5,10,20	T322F187(1)010AS	10.0	8	
220.0	F	5,10,20	T322F227(1)010AS	10.0	8	
15 VOLT RATING AT 85°C — 10 VOLT RATING AT 125°C						
1.5	A	5,10,20	T322A155(1)015AS	0.5	4	
1.8	A	5,10,20	T322A185(1)015AS	0.5	4	
2.2	A	5	T322A225J015AS	0.5	4	
2.2	A	10	T322A225K015AS	0.5	4	CX05H225K
2.2	A	20	T322A225M015AS	0.5	4	CX05H225M
2.7	B	5,10,20	T322B275(1)015AS	0.5	4	
3.3	B	5,10,20	T322B335(1)015AS	0.5	4	
3.9	B	5,10,20	T322B395(1)015AS	0.5	4	
4.7	B	5,10,20	T322B475(1)015AS	0.6	4	
5.6	B	5,10,20	T322B565(1)015AS	0.7	4	
6.8	B	5	T322B685J015AS	0.8	6	
6.8	B	10	T322B685K015AS	0.8	6	CX05H685K
6.8	B	20	T322B685M015AS	0.8	6	CX05H685M
8.2	C	5,10,20	T322C825(1)015AS	1.0	6	
10.0	C	5,10,20	T322C106(1)015AS	1.2	6	
12.0	C	5,10,20	T322C126(1)015AS	1.4	6	
15.0	C	5	T322C156J015AS	1.5	6	
15.0	C	10	T322C156K015AS	1.5	6	CX05H156K
15.0	C	20	T322C156M015AS	1.5	6	CX05H156M

(1) To complete KEMET Part Number, insert Capacitance Tolerance Symbol as follows: M — ±20%, K — ±10%, J — ±5%
Bold Face lines indicate preferred part types and values.

KEMET Electronics Corporation, P.O. Box 5928, Greenville, S.C. 29606 (864) 963-6300

33.0	D	5,10,20	T322D336J015AS	4.0	6	CX05H336K CX05H336M
33.0	D	10	T322D336K015AS	4.0	6	
33.0	D	20	T322D336M015AS	4.0	6	
39.0	E	5,10,20	T322E396(1)015AS	4.7	6	
47.0	E	5,10,20	T322E476(1)015AS	5.0	6	
56.0	E	5,10,20	T322E566(1)015AS	6.7	6	
68.0	E	5,10,20	T322E686(1)015AS	8.2	6	
82.0	E	5,10,20	T322E826(1)015AS	9.8	8	
100.0	E	5,10,20	T322E107(1)015AS	10.0	8	
120.0	F	5,10,20	T322F127(1)015AS	10.0	8	
150.0	F	5,10,20	T322F157(1)015AS	10.0	8	
20 VOLT RATING AT 85°C — 13 VOLT RATING AT 125°C						
1.0	A	5,10,20	T322A105(1)020AS	0.5	4	CX05J155K CX05J155M
1.2	A	5,10,20	T322A125(1)020AS	0.5	4	
1.5	A	5	T322A155J020AS	0.5	4	
1.5	A	10	T322A155K020AS	0.5	4	
1.5	A	20	T322A155M020AS	0.5	4	
1.8	B	5,10,20	T322B185(1)020AS	0.5	4	CX05J475K CX05J475M
2.2	B	5,10,20	T322B225(1)020AS	0.5	4	
2.7	B	5,10,20	T322B275(1)020AS	0.5	4	
3.3	B	5,10,20	T322B335(1)020AS	0.5	4	
3.9	B	5,10,20	T322B395(1)020AS	0.6	4	
4.7	B	5	T322B475J020AS	0.8	4	
4.7	B	10	T322B475K020AS	0.8	4	
4.7	B	20	T322B475M020AS	0.8	4	
5.6	C	5,10,20	T322C565(1)020AS	0.9	4	CX05J126K CX05J126M
6.8	C	5,10,20	T322C685(1)020AS	1.1	6	
8.2	C	5,10,20	T322C825(1)020AS	1.3	6	
10.0	C	5,10,20	T322C106(1)020AS	1.6	6	
12.0	D	5	T322D126J020AS	1.9	6	CX05J156K CX05J156M
12.0	D	10	T322D126K020AS	1.9	6	
12.0	D	20	T322D126M020AS	1.9	6	
15.0	D	5	T322D156J020AS	2.4	6	
15.0	D	10	T322D156K020AS	2.4	6	
15.0	D	20	T322D156M020AS	2.4	6	
18.0	D	5,10,20	T322D186(1)020AS	2.9	6	
22.0	D	5,10,20	T322D226(1)020AS	3.5	6	
27.0	E	5,10,20	T322E276(1)020AS	4.3	6	CX05K105K CX05K105M
33.0	E	5,10,20	T322E336(1)020AS	5.0	6	
39.0	E	5,10,20	T322E396(1)020AS	6.2	6	
47.0	E	5,10,20	T322E476(1)020AS	7.5	6	
56.0	E	5,10,20	T322E566(1)020AS	8.9	6	
68.0	E	5,10,20	T322E686(1)020AS	10.0	6	
82.0	F	5,10,20	T322F826(1)020AS	10.0	8	
100.0	F	5,10,20	T322F107(1)020AS	10.0	8	
25 VOLT RATING AT 85°C — 17 VOLT RATING AT 125°C						
0.47	A	5,10,20	T322A474(1)025AS	0.5	3	CX01K155K CX01K155M
0.56	A	5,10,20	T322A564(1)025AS	0.5	3	
0.68	A	5,10,20	T322A684(1)025AS	0.5	3	
0.82	A	5,10,20	T322A824(1)025AS	0.5	3	
1.0	A	5	T322A105J025AS	0.5	3	
1.0	A	10	T322A105K025AS	0.5	3	CX01K185K CX01K185M
1.0	A	20	T322A105M025AS	0.5	3	
1.2	B	5,10,20	T322B125(1)025AS	0.5	3	
1.5	B	5	T322B155J025AS	0.5	3	
1.5	B	10	T322B155K025AS	0.5	3	
1.5	B	20	T322B155M025AS	0.5	3	
1.8	B	5	T322B185J025AS	0.5	3	
1.8	B	10	T322B185K025AS	0.5	3	
1.8	B	20	T322B185M025AS	0.5	3	
2.2	B	5	T322B225J025AS	0.5	3	
2.2	B	10	T322B225K025AS	0.5	3	CX05K225K

(1) To complete KEMET Part Number, insert Capacitance Tolerance Symbol as follows: M — ±20%, K — ±10%, J — ±5%
Bold Face lines indicate preferred part types and values.

3.9	C	5,10,20	T322C395(1)025AS	0.8	3	
4.7	C	5,10,20	T322C475(1)025AS	0.9	4	
5.6	C	5,10,20	T322C565(1)025AS	1.1	4	
6.8	C	5	T322C685J025AS	1.4	4	
6.8	C	10	T322C685K025AS	1.4	4	CX05K685K
6.8	C	20	T322C685M025AS	1.4	4	CX05K685M
8.2	C	5,10,20	T322C825(1)025AS	1.5	4	
10.0	C	5	T322C106J025AS	1.5	4	
10.0	C	10	T322C106K025AS	1.5	4	CX05K106K
10.0	C	20	T322C106M025AS	1.5	4	CX05K106M
12.0	D	5,10,20	T322D126(1)025AS	2.4	4	
15.0	D	5,10,20	T322D156(1)025AS	3.0	4	
18.0	E	5,10,20	T322E186(1)025AS	3.6	6	
22.0	E	5,10,20	T322E226(1)025AS	4.4	6	
27.0	E	5,10,20	T322E276(1)025AS	5.4	6	
33.0	E	5,10,20	T322E336(1)025AS	6.6	6	
39.0	E	5,10,20	T322E396(1)025AS	7.8	6	
47.0	E	5,10,20	T322E476(1)025AS	9.4	6	
56.0	F	5,10,20	T322F566(1)025AS	10.0	6	
68.0	F	5,10,20	T322F686(1)025AS	10.0	6	
35 VOLT RATING AT 85°C — 23 VOLT RATING AT 125°C						
0.1	A	5,10,20	T322A104(1)035AS	0.5	3	
0.12	A	5,10,20	T322A124(1)035AS	0.5	3	
0.15	A	5,10,20	T322A154(1)035AS	0.5	3	
0.18	A	5,10,20	T322A184(1)035AS	0.5	3	
0.22	A	5,10,20	T322A224(1)035AS	0.5	3	
0.27	A	5,10,20	T322A274(1)035AS	0.5	3	
0.33	A	5	T322A334J035AS	0.5	3	
0.33	A	10	T322A334K035AS	0.5	3	CX05M334K
0.33	A	20	T322A334M035AS	0.5	3	CX05M334M
0.39	A	5,10,20	T322A394(1)035AS	0.5	3	
0.47	A	5	T322A474J035AS	0.5	3	
0.47	A	10	T322A474K035AS	0.5	3	CX05M474K
0.47	A	20	T322A474M035AS	0.5	3	CX05M474M
0.56	B	5	T322B564J035AS	0.5	3	
0.56	B	10	T322B564K035AS	0.5	3	CX01M564K
0.56	B	20	T322B564M035AS	0.5	3	CX01M564M
0.68	B	5	T322B684J035AS	0.5	3	
0.68	B	10	T322B684K035AS	0.5	3	CX01M684K
0.68	B	20	T322B684M035AS	0.5	3	CX01M684M
0.82	B	5	T322B824J035AS	0.5	3	
0.82	B	10	T322B824K035AS	0.5	3	CX01M824K
0.82	B	20	T322B824M035AS	0.5	3	CX01M824M
1.0	B	5	T322B105J035AS	0.5	3	
1.0	B	10	T322B105K035AS	0.5	3	CX01M105K
1.0	B	20	T322B105M035AS	0.5	3	CX01M105M
1.2	B	5	T322B125J035AS	0.5	3	
1.2	B	10	T322B125K035AS	0.5	3	CX01M125K
1.2	B	20	T322B125M035AS	0.5	3	CX01M125M
1.5	B	5	T322B155J035AS	0.5	3	
1.5	B	10	T322B155K035AS	0.5	3	CX05M155K
1.5	B	20	T322B155M035AS	0.5	3	CX05M155M
1.8	C	5,10,20	T322C185(1)035AS	0.5	3	
2.2	C	5,10,20	T322C225(1)035AS	0.6	3	
2.7	C	5,10,20	T322C275(1)035AS	0.8	3	
3.3	C	5	T322C335J035AS	0.9	4	
3.3	C	10	T322C335K035AS	0.9	4	CX05M335K
3.3	C	20	T322C335M035AS	0.9	4	CX05M335M
3.9	C	5	T322C395J035AS	1.1	4	
3.9	C	10	T322C395K035AS	1.1	4	CX05M395K
3.9	C	20	T322C395M035AS	1.1	4	CX05M395M
4.7	C	5	T322C475J035AS	1.3	4	
4.7	C	10	T322C475K035AS	1.3	4	CX05M475K
4.7	C	20	T322C475M035AS	1.3	4	CX05M475M

(1) To complete KEMET Part Number, insert Capacitance Tolerance Symbol as follows: M — ±20%, K — ±10%, J — ±5%
Bold Face lines indicate preferred part types and values.

KEMET Electronics Corporation, P.O. Box 5928, Greenville, S.C. 29606 (864) 963-6300

10.0	D	5	T322D106J035AS	2.8	4	
10.0	D	10	T322D106K035AS	2.8	4	CX05M106K
10.0	D	20	T322D106M035AS	2.8	4	CX05M106M
12.0	E	5,10,20	T322E126(1)035AS	3.3	4	
15.0	E	5,10,20	T322E156(1)035AS	4.2	6	
18.0	E	5,10,20	T322E186(1)035AS	5.0	6	
22.0	E	5,10,20	T322E226(1)035AS	6.2	6	
27.0	E	5,10,20	T322E276(1)035AS	7.5	6	
33.0	E	5,10,20	T322E336(1)035AS	9.2	6	
39.0	F	5,10,20	T322F396(1)035AS	10.0	6	
47.0	F	5,10,20	T322F476(1)035AS	10.0	6	
50 VOLT RATING AT 85°C — 33 VOLT RATING AT 125°C						
0.1	A	5	T322A104J050AS	0.5	3	
0.1	A	10	T322A104K050AS	0.5	3	CX05N104K
0.1	A	20	T322A104M050AS	0.5	3	CX05N104M
0.12	A	5,10,20	T322A124(1)050AS	0.5	3	
0.15	A	5	T322A154J050AS	0.5	3	
0.15	A	10	T322A154K050AS	0.5	3	CX05N154K
0.15	A	20	T322A154M050AS	0.5	3	CX05N154M
0.18	A	5,10,20	T322A184(1)050AS	0.5	3	
0.22	A	5	T322A224J050AS	0.5	3	
0.22	A	10	T322A224K050AS	0.5	3	CX05N224K
0.22	A	20	T322A224M050AS	0.5	3	CX05N224M
0.27	A	5,10,20	T322A274(1)050AS	0.5	3	
0.33	B	5	T322B334J050AS	0.5	3	
0.33	B	10	T322B334K050AS	0.5	3	CX05N334K
0.33	B	20	T322B334M050AS	0.5	3	CX05N334M
0.39	B	5	T322B394J050AS	0.5	3	
0.39	B	10	T322B394K050AS	0.5	3	CX05N394K
0.39	B	20	T322B394M050AS	0.5	3	CX05N394M
0.47	B	5	T322B474J050AS	0.5	3	
0.47	B	10	T322B474K050AS	0.5	3	CX05N474K
0.47	B	20	T322B474M050AS	0.5	3	CX05N474M
0.56	B	5,10,20	T322B564(1)050AS	0.5	3	
0.68	B	5	T322B684J050AS	0.5	3	
0.68	B	10	T322B684K050AS	0.5	3	CX05N684K
0.68	B	20	T322B684M050AS	0.5	3	CX05N684M
0.82	B	5,10,20	T322B824(1)050AS	0.5	3	
1.0	B	5	T322B105J050AS	0.5	3	
1.0	B	10	T322B105K050AS	0.5	3	CX05N105K
1.0	B	20	T322B105M050AS	0.5	3	CX05N105M
1.2	C	5,10,20	T322C125(1)050AS	0.5	3	
1.5	C	5	T322C155J050AS	0.6	4	
1.5	C	10	T322C155K050AS	0.6	4	CX05N155K
1.5	C	20	T322C155M050AS	0.6	4	CX05N155M
1.8	C	5,10,20	T322C185(1)050AS	0.7	4	
2.2	C	5	T322C225J050AS	0.9	4	
2.2	C	10	T322C225K050AS	0.9	4	CX05N225K
2.2	C	20	T322C225M050AS	0.9	4	CX05N225M
2.7	D	5,10,20	T322D275(1)050AS	1.1	4	
3.3	D	5	T322D335J050AS	1.3	4	
3.3	D	10	T322D335K050AS	1.3	4	CX05N335K
3.3	D	20	T322D335M050AS	1.3	4	CX05N335M
3.9	D	5,10,20	T322D395(1)050AS	1.6	4	
4.7	D	5	T322D475J050AS	1.9	4	
4.7	D	10	T322D475K050AS	1.9	4	CX05N475K
4.7	D	20	T322D475M050AS	1.9	4	CX05N475M
5.6	E	5,10,20	T322E565(1)050AS	2.2	4	
6.8	E	5,10,20	T322E685(1)050AS	2.7	4	
8.2	E	5,10,20	T322E825(1)050AS	3.2	4	
10.0	E	5,10,20	T322E106(1)050AS	4.0	6	
12.0	F	5,10,20	T322F126(1)050AS	4.8	6	
15.0	F	5,10,20	T322F156(1)050AS	6.0	6	
18.0	F	5,10,20	T322F186(1)050AS	7.2	6	
22.0	F	5,10,20	T322F226(1)050AS	8.8	6	

(1) To complete KEMET Part Number, insert Capacitance Tolerance Symbol as follows: M — ±20%, K — ±10%, J — ±5%
Bold Face lines indicate preferred part types and values.

properties. All cases utilize gold color plastic which permits laser marking with outstanding permanency and legibility. The polarity is indicated by a + sign permanently marked on the case. The radius on the two vertical edges at the positive end of B, C, and D Cases can be used as a sensing dimension for automatic insertion processes.

T340 Series

The compact space saving T340 Series is transfer molded in precision dies with a high impact resistant plastic having excellent electrical, physical, and moisture resistant properties. The gold color plastic case utilized permits laser marking with outstanding permanency and legibility.

Marking is provided on the top of the case to allow visual inspection for proper polarity and placement after insertion. In addition, positive polarity identification is achieved by an easily recognized molded radius on the positive end of the case. This physical polarity identification is readily observed after capacitor placement as a further aid to the top marking in prevention of possible reverse insertion.

PERFORMANCE CHARACTERISTICS

- **CAPACITANCE/VOLTAGE RANGE:**
T330: 0.1-220 μ F, 6-50 Volts.
T340: 0.1-330 μ F, 6-50 Volts.
- **CAPACITANCE TOLERANCE:** Available in standard EIA nominal values with $\pm 20\%$ tolerance standard, $\pm 10\%$ and $\pm 5\%$ available on special order.
- **DISSIPATION FACTOR:** Maximum DF limits are shown in corresponding series part number listing. See Application Notes Section, page 78.
- **DC LEAKAGE CURRENT:** Maximum leakage values at 25°C are shown in part number listings, pages 51, 52, 55, 56 and 57. See Application Notes Section, page 76.

Standoffs, located in the base of all case sizes, allow air circulation and also allow easy removal of wire and circuit board solder joints. With ESR values, the T340 Series features excellent ESR and DF characteristics. The T340 Series capacitors are $\pm 20\%$; $\pm 10\%$; $\pm 5\%$ (special order) capacitance tolerance. T340 Series capacitors are highly reliable with characteristics typical of military test standards.

- **RATED VOLTAGE; WORKING VOLTAGE; REVERSE VOLTAGE:** See Application Notes Section 77 for description.
- **IMPEDANCE and ESR:** See Application Notes Section 77 & 78 for additional information. Refer to table below.
- **AC RIPPLE VOLTAGE:** Permissible AC ripple voltage, ESR of the capacitor and the power dissipation are a function of case size. Thermal capacities for various case sizes have been determined and are listed in Application Notes Section 78. For additional description see page 78.

T330/T340 ESR (OHMS) at 100 kHz @ +25°C

(The ESR values provided below are for reference only. No warranty, as stated on page 3 and reincorporated here, is made as to the accuracy of these values for any particular T330/T340 Series product.)

Cap. μ F	6 Volt	10 Volt	15 Volt	20 Volt	25 Volt	35 Volt	50 Volt
0.10						26.0	26.0
0.15						21.0	21.0
0.22						17.0	17.0
0.33						15.0	15.0
0.47						13.0	13.0
0.68						10.0	10.0
1.00						8.0	8.0
1.50					8.0	6.0	5.0
2.20				7.0	6.0	5.0	3.5
3.30			6.0	5.5	5.0	4.0	3.0
4.70		8.0	5.0	4.5	4.0	3.0	2.5
6.80	8.0	6.0	4.0	3.6	3.1	2.5	2.0
10.0	6.0	5.0	3.2	2.9	2.5	2.0	1.6
15.0	5.0	3.7	2.5	2.3	2.0	1.6	1.2
22.0	3.7	2.7	2.0	1.8	1.5	1.3	1.0
33.0	3.0	2.1	1.6	1.4	1.2	1.0	
47.0	2.0	1.7	1.3	1.2	1.0	0.8	
68.0	1.8	1.3	1.0	0.9	0.8		
100.0	1.6	1.0	0.8	0.6			
150.0	0.9	0.8	0.6				
220.0	0.9						
330.0	0.7						

Series	Case Size
T330/T340	A B C
T330	D
T340 only	D/F E

Maximum Power Dissipation:

- **ENVIRONMENTAL CONSIDERATION:**
 - Shock Test: MIL-STD-202, Method 2000
 - Thermal Shock, MIL-STD-202, Method 2001
 - Moisture Resistance: MIL-STD-202, Method 2008
 - Solderability: MIL-STD-202, Method 2009
 For additional Environmental Test Information see Application Notes Section 82.
- **LEAD MATERIAL:** Solder coated steel wire. See Application Notes Section 76, MIL-STD-1276.
- **LEAD TAPE and REEL:** Reeling per Application Notes Section 76, pages 71 and 73 for additional information.

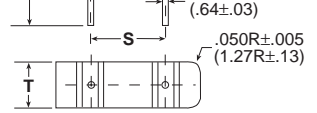
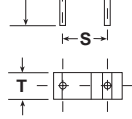

No
On
sta
be

DIMENSIONS — INCHES & (MILLIMETERS)

CASE SIZE	H CASE HEIGHT	W CASE WIDTH	T CASE THICKNESS	E CASE TO WIRE
A	.345 ± .008 (8.76 ± .203)	.230 ± .005 (5.84 ± .127)	.105 ± .005 (2.67 ± .127)	.050 ± .010 (1.27 ± .25)
B	.225 ± .015 (5.71 ± 0.38)	.285 ± .015 (7.24 ± 0.38)	.170 ± .015 (4.32 ± 0.38)	.042 ± .010 (1.07 ± .25)
C	.325 ± .015 (8.26 ± 0.38)	.325 ± .015 (8.26 ± 0.38)	.170 ± .015 (4.32 ± 0.38)	.062 ± .010 (1.57 ± 0.25)
D	.375 ± .015 (9.53 ± 0.38)	.600 ± .015 (15.24 ± 0.38)	.195 ± .015 (4.95 ± 0.38)	.200 ± .010 (5.08 ± 0.25)

ORDERING INFORMATION

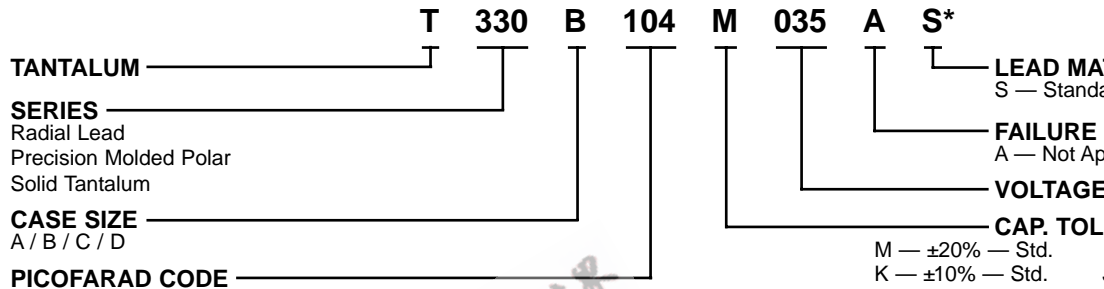

***Part Number Example: T330B104M035AS (14 digits – no spaces)**

MARKING INFORMATION

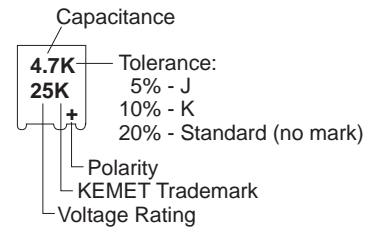

10.0	A	T330A106(1)010AS	1	6
12.0	A	T330A126(1)010AS	1	6
15.0	A	T330A156(1)010AS	1	6
15 VOLT RATING AT 85°C — 10 VOLT RATING AT 125°C				
8.2	A	T330A825(1)015AS	1	6
20 VOLT RATING AT 85°C — 13 VOLT RATING AT 125°C				
5.6	A	T330A565(1)020AS	1	6
6.8	A	T330A685(1)020AS	1	6
25 VOLT RATING AT 85°C — 17 VOLT RATING AT 125°C				
3.3	A	T330A335(1)025AS	1	4
3.9	A	T330A395(1)025AS	1	4
4.7	A	T330A475(1)025AS	1	4
35 VOLT RATING AT 85°C — 23 VOLT RATING AT 125°C				
0.10	A	T330A104(1)035AS	1	3
0.12	A	T330A124(1)035AS	1	3
0.15	A	T330A154(1)035AS	1	3
0.18	A	T330A184(1)035AS	1	3
0.22	A	T330A224(1)035AS	1	3
0.27	A	T330A274(1)035AS	1	3
0.33	A	T330A334(1)035AS	1	3

0.82	A	T330A824(1)035AS
1.0	A	T330A105(1)035AS
1.2	A	T330A125(1)035AS
1.5	A	T330A155(1)035AS
1.8	A	T330A185(1)035AS
2.2	A	T330A225(1)035AS
2.7	A	T330A275(1)035AS
50 VOLT RATING AT 85°C — 33 VOLT RATING AT 125°C		
0.10	A	T330A104(1)050AS
0.12	A	T330A124(1)050AS
0.15	A	T330A154(1)050AS
0.18	A	T330A184(1)050AS
0.22	A	T330A224(1)050AS
0.27	A	T330A274(1)050AS
0.33	A	T330A334(1)050AS
0.39	A	T330A394(1)050AS
0.47	A	T330A474(1)050AS
0.56	A	T330A564(1)050AS
0.68	A	T330A684(1)050AS
0.82	A	T330A824(1)050AS
1.0	A	T330A105(1)050AS
1.2	A	T330A125(1)050AS
1.5	A	T330A155(1)050AS

B, C & D CASES

CAPACITANCE μF	CASE SIZE	KEMET PART NUMBER	D.C. LEAKAGE μA@25°C	MAX. DISSIPATION FACTOR %@25°C, 120Hz
6 VOLT RATING AT 85°C — 4 VOLT RATING AT 125°C				
10.0	B	T330B106(1)006AS	1	6
12.0	B	T330B126(1)006AS	1	6
15.0	B	T330B156(1)006AS	1	6
18.0	B	T330B186(1)006AS	1	6
22.0	B	T330B226(1)006AS	1	6
27.0	C	T330C276(1)006AS	1	6
33.0	C	T330C336(1)006AS	1	6
39.0	C	T330C396(1)006AS	1	6
47.0	C	T330C476(1)006AS	2	6
56.0	C	T330C566(1)006AS	5	6
68.0	C	T330C686(1)006AS	5	6
82.0	D	T330D826(1)006AS	5	6
100.0	D	T330D107(1)006AS	5	6
120.0	D	T330D127(1)006AS	5	6
150.0	D	T330D157(1)006AS	5	6
180.0	D	T330D187(1)006AS	10	6
220.0	D	T330D227(1)006AS	10	8
10 VOLT RATING AT 85°C — 7 VOLT RATING AT 125°C				
5.6	B	T330B565(1)010AS	1	6
6.8	B	T330B685(1)010AS	1	6
8.2	B	T330B825(1)010AS	1	6
10.0	B	T330B106(1)010AS	1	6
12.0	B	T330B126(1)010AS	1	6
15.0	B	T330B156(1)010AS	1	6
18.0	C	T330C186(1)010AS	1	6
22.0	C	T330C226(1)010AS	2	6
27.0	C	T330C276(1)010AS	2	6

CAPACITANCE μF	CASE SIZE	KEMET PART NUMBER
10 VOLT RATING AT 85°C — 7 VOLT RATING AT 125°C		
33.0	C	T330C336(1)010AS
39.0	C	T330C396(1)010AS
47.0	D	T330D476(1)010AS
56.0	D	T330D566(1)010AS
68.0	D	T330D686(1)010AS
82.0	D	T330D826(1)010AS
100.0	D	T330D107(1)010AS
120.0	D	T330D127(1)010AS
150.0	D	T330D157(1)010AS
15 VOLT RATING AT 85°C — 10 VOLT RATING AT 125°C		
3.9	B	T330B395(1)015AS
4.7	B	T330B475(1)015AS
5.6	B	T330B565(1)015AS
6.8	B	T330B685(1)015AS
8.2	B	T330B825(1)015AS
10.0	C	T330C106(1)015AS
12.0	C	T330C126(1)015AS
15.0	C	T330C156(1)015AS
18.0	C	T330C186(1)015AS
22.0	C	T330C226(1)015AS
27.0	C	T330C276(1)015AS
33.0	C	T330C336(1)015AS
39.0	D	T330D396(1)015AS
47.0	D	T330D476(1)015AS
56.0	D	T330D566(1)015AS
68.0	D	T330D686(1)015AS
82.0	D	T330D826(1)015AS

(1) To complete Part Number insert Capacitance Tolerance Symbol in the 9th character, M — ±20%, K — ±10%, J — ±5%.

Bold face lines indicate popular part types and values.

Higher voltage and better capacitance tolerance product may be substituted for an order within the same case size at KEMET'S option.

KEMET Electronics Corporation, P.O. Box 5928, Greenville, S.C. 29606 (864) 963-6300

8.2	C	T330C825(1)025AS	1	6
10.0	C	T330C106(1)025AS	1	6
12.0	C	T330C126(1)025AS	1	6
15.0	C	T330C156(1)025AS	2	6
18.0	D	T330D186(1)025AS	5	6
22.0	D	T330D226(1)025AS	5	6
27.0	D	T330D276(1)025AS	5	6
33.0	D	T330D336(1)025AS	5	6
39.0	D	T330D396(1)025AS	10	6
47.0	D	T330D476(1)025AS	10	6
35 VOLT RATING AT 85°C—23 VOLT RATING AT 125°C				
0.10	B	T330B104(1)035AS	1	6
0.12	B	T330B124(1)035AS	1	6
0.15	B	T330B154(1)035AS	1	6
0.18	B	T330B184(1)035AS	1	6
0.22	B	T330B224(1)035AS	1	6
0.27	B	T330B274(1)035AS	1	6
0.33	B	T330B334(1)035AS	1	6
0.39	B	T330B394(1)035AS	1	6
0.47	B	T330B474(1)035AS	1	6
0.56	B	T330B564(1)035AS	1	6
0.68	B	T330B684(1)035AS	1	6
0.82	B	T330B824(1)035AS	1	6
1.0	B	T330B105(1)035AS	1	6
1.2	B	T330B125(1)035AS	1	6
1.5	B	T330B155(1)035AS	1	6
1.8	B	T330B185(1)035AS	1	6
2.2	B	T330B225(1)035AS	1	6
2.7	B	T330B275(1)035AS	1	6
3.3	B	T330B335(1)035AS	1	6
3.9	C	T330C395(1)035AS	1	6
4.7	C	T330C475(1)035AS	1	6
5.6	C	T330C565(1)035AS	1	6

22.0	D	T330D226(1)035AS
27.0	D	T330D276(1)035AS
33.0	D	T330D336(1)035AS
50 VOLT RATING AT 85°C—33 VOLT RATING AT 125°C		
0.10	B	T330B104(1)050AS
0.12	B	T330B124(1)050AS
0.15	B	T330B154(1)050AS
0.18	B	T330B184(1)050AS
0.22	B	T330B224(1)050AS
0.27	B	T330B274(1)050AS
0.33	B	T330B334(1)050AS
0.39	B	T330B394(1)050AS
0.47	B	T330B474(1)050AS
0.56	B	T330B564(1)050AS
0.68	B	T330B684(1)050AS
0.82	B	T330B824(1)050AS
1.0	B	T330B105(1)050AS
1.2	B	T330B125(1)050AS
1.5	B	T330B155(1)050AS
1.8	B	T330B185(1)050AS
2.2	B	T330B225(1)050AS
2.7	C	T330C275(1)050AS
3.3	C	T330C335(1)050AS
3.9	C	T330C395(1)050AS
4.7	C	T330C475(1)050AS
5.6	C	T330C565(1)050AS
6.8	D	T330D685(1)050AS
8.2	D	T330D825(1)050AS
10.0	D	T330D106(1)050AS
12.0	D	T330D126(1)050AS
15.0	D	T330D156(1)050AS
18.0	D	T330D186(1)050AS

(1) To complete Part Number insert Capacitance Tolerance Symbol in the 9th character, M — ±20%, K — ±10%, J — ±5%.

Bold face lines indicate popular part types and values.

Higher voltage and better capacitance tolerance product may be substituted for an order within the same case size at KEMET'S option.

电子產品世界

 EEPW.com.cn

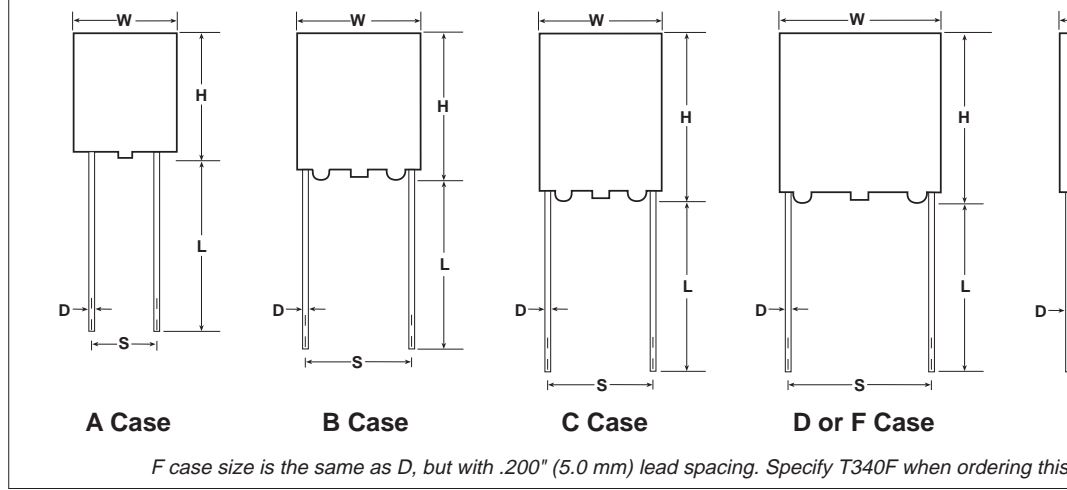

DIMENSIONS — INCHES & MILLIMETERS

CASE SIZE	H** (MAX)		W (MAX)		T (MAX)		LEAD SPACING S		LEAD LENGTH L	
	H		W		T		Inches	mm	Inches	mm
	Inches	mm	Inches	mm	inches	mm	±.020	±.5	±.078	±2.0
A	.287	7.3	.185	4.7	.165	4.2	.100	2.5	.600	15.0
B	.327	8.3	.283	7.2	.157	4.0	.200	5.0	.600	15.0
C	.413	10.5	.287	7.3	.169	4.3	.200	5.0	.600	15.0
D	.413	10.5	.484	12.3	.287	7.3	.400	10.0	.600	15.0
E	.413	10.5	.484	12.3	.484	12.3	.400	10.0	.600	15.0
F	.413	10.5	.484	12.3	.287	7.3	.200	5.0	.600	15.0

**Includes Standoff Height of .015 ± .005" (.38 ± .13 mm) for All Case Sizes.

ORDERING INFORMATION

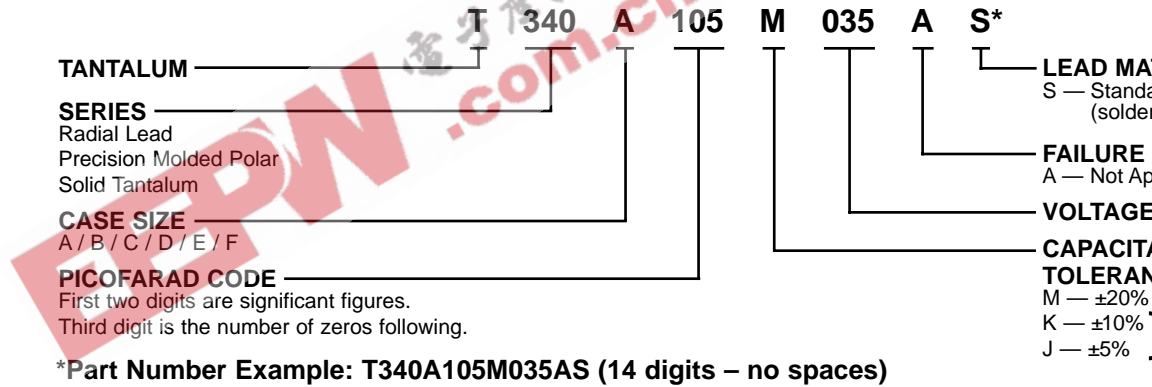

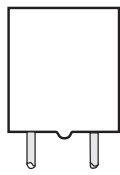

A Case



B Case



C Case

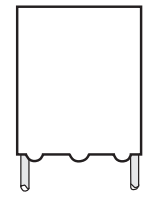

D & F Case



E Case

European

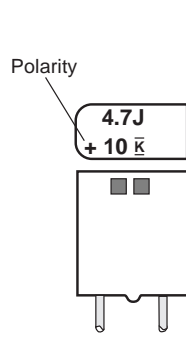

A Case

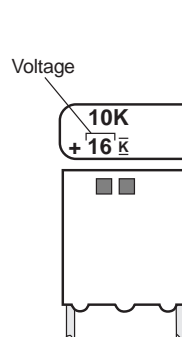

B Case

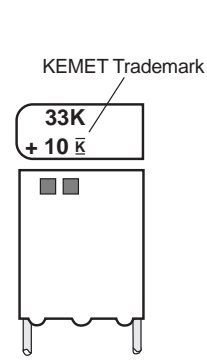

C Case

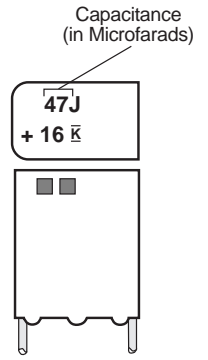

D & F Case



E Case



□ □ = DIN. Specification Date Code

Insert Date Code as follows:

- 1st digit - represents year
 - 2nd digit - represents month
- | | | |
|----------|----------|-------------------------------|
| A - 1990 | F - 1995 | 1 - 9 for January - September |
| B - 1991 | G - 1996 | O for October |
| C - 1992 | H - 1997 | N for November |
| D - 1993 | J - 1998 | D for December |
| E - 1994 | K - 1999 | |

100.0	C	T340C107(1)003AS	5.0	6
6/6.3 VOLT RATING AT 85°C — 4 VOLT AT 125°C				
6.8	A	T340A685(1)006AS	1.0	6
10.0	B	T340B106(1)006AS	1.0	6
12.0	B	T340B126(1)006AS	1.0	6
15.0	B	T340B156(1)006AS	1.0	6
18.0	B	T340B186(1)006AS	1.0	6
22.0	B	T340B226(1)006AS	2.5	6
27.0	C	T340C276(1)006AS	2.5	6
33.0	C	T340C336(1)006AS	2.5	6
39.0	C	T340C396(1)006AS	2.5	6
47.0	C	T340C476(1)006AS	3.0	6
56.0	C	T340C566(1)006AS	5.0	6
68.0	C	T340C686(1)006AS	5.0	6
82.0	D/F	T340(2)826(1)006AS	5.0	6
100.0	D/F	T340(2)107(1)006AS	5.0	6
120.0	D/F	T340(2)127(1)006AS	5.0	6
150.0	D/F	T340(2)157(1)006AS	8.0	6
180.0	D/F	T340(2)187(1)006AS	10.0	6
220.0	D/F	T340(2)227(1)006AS	10.0	6
330.0	E	T340E337(1)006AS	10.0	8
10 VOLT RATING AT 85°C — 6 VOLT AT 125°C				
4.7	A	T340A475(1)010AS	1.0	6
5.6	B	T340B565(1)010AS	1.0	6
6.8	B	T340B685(1)010AS	1.0	6
8.2	B	T340B825(1)010AS	1.0	6
10.0	B	T340B106(1)010AS	1.0	6
12.0	B	T340B126(1)010AS	1.0	6
15.0	B	T340B156(1)010AS	3.0	6
18.0	C	T340C186(1)010AS	3.0	6
22.0	C	T340C226(1)010AS	3.0	6
27.0	C	T340C276(1)010AS	3.0	6
33.0	C	T340C336(1)010AS	5.0	6
39.0	C	T340C396(1)010AS	5.0	6
47.0	D/F	T340(2)476(1)010AS	5.0	6
56.0	D/F	T340(2)566(1)010AS	5.0	6
68.0	D/F	T340(2)686(1)010AS	5.0	6
82.0	D/F	T340(2)826(1)010AS	8.0	6
100.0	D/F	T340(2)107(1)010AS	10.0	6
120.0	D/F	T340(2)127(1)010AS	10.0	6
150.0	D/F	T340(2)157(1)010AS	10.0	6
220.0	E	T340E227(1)010AS	10.0	6
15/16 VOLT RATING AT 85°C — 10 VOLT AT 125°C				
3.3	A	T340A335(1)015AS	1.0	6
3.9	B	T340B395(1)015AS	1.0	6
4.7	B	T340B475(1)015AS	1.0	6
5.6	B	T340B565(1)015AS	1.0	6
6.8	B	T340B685(1)015AS	1.0	6
8.2	B	T340B825(1)015AS	1.0	6
10.0	B	T340B106(1)015AS	3.0	6

(1) To complete KEMET Part Number, insert M — ±20%, K — ±10%, or J — ±5% for capacitance tolerance as shown in T340 ordering information.
(2) To complete KEMET Part Number, insert letter "D" for 10.0 mm (.394) lead spacing or letter "F" for 5.0 mm (.197) lead spacing. See page 10 for more information.
Bold face lines indicate popular part types and values.

Higher voltage and better capacitance tolerance product may be substituted for an order within the same case size at KEMET'S option.

KEMET Electronics Corporation, P.O. Box 5928, Greenville, S.C. 29606 (864) 963-6300

39.0	D/F	T340(2)396(1)015AS	7.0	6
47.0	D/F	T340(2)476(1)015AS	7.0	6
56.0	D/F	T340(2)566(1)015AS	8.0	6
68.0	D/F	T340(2)686(1)015AS	9.0	6
82.0	D/F	T340(2)826(1)015AS	10.0	6
100.0	E	T340E107(1)015AS	10.0	6
150.0	E	T340E157(1)015AS	10.0	6
20 VOLT RATING AT 85°C — 13 VOLT AT 125°C				
2.2	A	T340A225(1)020AS	1.0	6
3.3	B	T340B335(1)020AS	1.0	6
4.7	B	T340B475(1)020AS	1.5	6
6.8	B	T340B685(1)020AS	2.5	6
15.0	C	T340C156(1)020AS	5.0	6
47.0	D	T340D476(1)020AS	9.0	6
100.0	E	T340E107(1)020AS	10.0	6
25 VOLT RATING AT 85°C — 16 VOLT AT 125°C				
1.5	A	T340A155(1)025AS	1.0	6
2.7	B	T340B275(1)025AS	1.0	6
3.3	B	T340B335(1)025AS	1.0	6
3.9	B	T340B395(1)025AS	1.0	6
4.7	B	T340B475(1)025AS	2.0	6
5.6	C	T340C565(1)025AS	2.0	6
6.8	C	T340C685(1)025AS	3.0	6
8.2	C	T340C825(1)025AS	3.0	6
10.0	C	T340C106(1)025AS	3.5	6
12.0	C	T340C126(1)025AS	3.5	6
15.0	C	T340C156(1)025AS	4.0	6
18.0	D/F	T340(2)186(1)025AS	5.0	6
22.0	D/F	T340(2)226(1)025AS	5.5	6
27.0	D/F	T340(2)276(1)025AS	7.0	6
33.0	D/F	T340(2)336(1)025AS	8.0	6
39.0	D/F	T340(2)396(1)025AS	10.0	6
47.0	D/E/F	T340(2)476(1)025AS	10.0	6
68.0	E	T340E686(1)025AS	10.0	6
35 VOLT RATING AT 85°C — 23 VOLT AT 125°C				
0.1	A	T340A104(1)035AS	1.0	6
0.15	A	T340A154(1)035AS	1.0	6
0.22	A	T340A224(1)035AS	1.0	6
0.33	A	T340A334(1)035AS	1.0	6
0.47	A	T340A474(1)035AS	1.0	6
0.68	A	T340A684(1)035AS	1.0	6
1.0	A	T340A105(1)035AS	1.0	6
1.2	B	T340B125(1)035AS	1.0	6
1.5	B	T340B155(1)035AS	1.0	6
1.8	B	T340B185(1)035AS	1.0	6
2.2	B	T340B225(1)035AS	1.0	6
2.7	B	T340B275(1)035AS	1.0	6
3.3	B/C	T340(2)335(1)035AS	1.0	6

(1) To complete KEMET Part Number, insert M — ±20%, K — ±10%, or J — ±5% for capacitance tolerance as shown in T340 ordering information.

(2) To complete KEMET Part Number, insert letter "C" for 5.0 mm (.197") lead spacing, "D" for 10.0 mm (.394") lead spacing, "E" for 10.0 mm (.394") lead spacing, "F" for 10.0 mm (.394") lead spacing, "G" for 10.0 mm (.394") lead spacing, "H" for 10.0 mm (.394") lead spacing, "I" for 10.0 mm (.394") lead spacing, "J" for 10.0 mm (.394") lead spacing, "K" for 10.0 mm (.394") lead spacing, "L" for 10.0 mm (.394") lead spacing, "M" for 10.0 mm (.394") lead spacing, "N" for 10.0 mm (.394") lead spacing, "O" for 10.0 mm (.394") lead spacing, "P" for 10.0 mm (.394") lead spacing, "Q" for 10.0 mm (.394") lead spacing, "R" for 10.0 mm (.394") lead spacing, "S" for 10.0 mm (.394") lead spacing, "T" for 10.0 mm (.394") lead spacing, "U" for 10.0 mm (.394") lead spacing, "V" for 10.0 mm (.394") lead spacing, "W" for 10.0 mm (.394") lead spacing, "X" for 10.0 mm (.394") lead spacing, "Y" for 10.0 mm (.394") lead spacing, "Z" for 10.0 mm (.394") lead spacing.

Bold face lines indicate popular part types and values.

Higher voltage and better capacitance tolerance product may be substituted for an order within the same case size at KEMET'S option.

12.0	D/F	T340(2)126(1)035AS	5.0	6
15.0	D/F	T340(2)156(1)035AS	5.0	6
18.0	D/F	T340(2)186(1)035AS	8.0	6
22.0	D/F	T340(2)226(1)035AS	8.0	6
27.0	D/F	T340(2)276(1)035AS	10.0	6
33.0	D/E/F	T340(2)336(1)035AS	10.0	6
47.0	E	T340E476(1)035AS	10.0	6
40 VOLT RATING AT 85°C — 32 VOLT AT 100°C				
0.1	A	T340A104(1)040AS	1.0	6
0.15	A	T340A154(1)040AS	1.0	6
0.22	A	T340A224(1)040AS	1.0	6
0.33	A	T340A334(1)040AS	1.0	6
0.47	A	T340A474(1)040AS	1.0	6
0.68	A	T340A684(1)040AS	1.0	6
1.0	A	T340A105(1)040AS	1.0	6
1.5	B	T340B155(1)040AS	1.0	6
2.2	B	T340B225(1)040AS	1.7	6
3.3	C	T340C335(1)040AS	2.3	6
4.7	C	T340C475(1)040AS	3.0	6
6.8	C	T340C685(1)040AS	3.5	6
10.0	D	T340D106(1)040AS	4.5	6
15.0	D	T340D156(1)040AS	6.0	6
22.0	D	T340D226(1)040AS	9.0	6
33.0	E	T340E336(1)040AS	10.0	6
47.0	E	T340E476(1)040AS	10.0	6
50 VOLT RATING AT 85°C — 33 VOLT AT 125°C				
0.1	A	T340A104(1)050AS	1.0	6
0.15	A	T340A154(1)050AS	1.0	6
0.22	A	T340A224(1)050AS	1.0	6
0.33	A	T340A334(1)050AS	1.0	6
0.39	B	T340B394(1)050AS	1.0	6
0.47	B	T340B474(1)050AS	1.0	6
0.56	B	T340B564(1)050AS	1.0	6
0.68	B	T340B684(1)050AS	1.0	6
0.82	B	T340B824(1)050AS	1.0	6
1.0	B	T340B105(1)050AS	1.0	6
1.2	B	T340B125(1)050AS	1.0	6
1.5	B/C	T340(2)155(1)050AS	1.1	6
1.8	B	T340B185(1)050AS	1.1	6
2.2	B/C	T340(2)225(1)050AS	1.5	6
2.7	C	T340C275(1)050AS	1.5	6
3.3	C/D	T340(2)335(1)050AS	2.5	6
3.9	C	T340C395(1)050AS	3.0	6
4.7	C/D	T340(2)475(1)050AS	3.5	6
5.6	C	T340C565(1)050AS	4.0	6
6.8	D/F	T340(2)685(1)050AS	5.0	6
8.2	D/F	T340(2)825(1)050AS	6.0	6
10.0	D/F	T340(2)106(1)050AS	7.0	6
12.0	D/F	T340(2)126(1)050AS	8.0	6
15.0	D/F	T340(2)156(1)050AS	9.0	6
18.0	D/F	T340(2)186(1)050AS	10.0	6
22.0	E	T340E226(1)050AS	10.0	6

- (1) To complete KEMET Part Number, insert M — ±20%, K — ±10%, or J — ±5% for capacitance tolerance as shown in T340 ordering information.
(2) To complete KEMET Part Number, insert letter "C" for 5.0 mm (.197") lead spacing, "D" for 10.0 mm (.394") lead spacing, "E" for 10.0 mm (.394") lead spacing. See page 53 for outline drawings.

Bold face lines indicate popular part types and values.

Higher voltage and better capacitance tolerance product may be substituted for an order within the same case size at KEMET'S option.

KEMET Electronics Corporation, P.O. Box 5928, Greenville, S.C. 29606 (864) 963-6300

- **CAPACITANCE/VOLTAGE RANGE:**
T370 Series: 0.68-220 μ F, 3-35 Volts.
T378 Series: 2.2-220 μ F, 3-35 Volts.
- **CAPACITANCE TOLERANCE:** Available in standard EIA nominal values with $\pm 20\%$ tolerance standard, +40% -20%, $\pm 10\%$ and $\pm 5\%$ are also available.
- **DISSIPATION FACTOR:** Maximum DF limits are shown in corresponding series part number listings on page 60. See Application Notes Section, page 76 for additional information.
- **DC LEAKAGE CURRENT:** Maximum leakage values at 25° are shown in part number listings, page 60. See Application Notes Section, page 76 for additional information.
- **RATED VOLTAGE; WORKING VOLTAGE; SURGE VOLTAGE; REVERSE VOLTAGE:** See Application Notes Section, pages 76 & 77 for description.
- **IMPEDANCE and ESR:** See Application Notes Section, pages 78 for description. Reference ESR values are listed in table below.
- **AC RIPPLE VOLTAGE:** Permissible AC ripple volt-

T370 ESR (OHMS) at 100 kHz @ +25°C
(The ESR values provided below are for reference only. No warranty, as stated on page 3 and reincorporated here, is made as to the accuracy of these values for any particular T370 Series product.)

Cap. μ F	6 Volt	10 Volt	15 Volt	20 Volt	25 Volt	35 Volt
0.68						10.0
1.00						8.0
1.50						6.0
2.20					6.0	5.0
3.30				5.5	5.0	4.0
4.70				4.5	4.0	3.0
6.80		6.0		3.6	3.1	2.5
10.0	6.0	5.0		2.9	2.5	2.0
15.0	5.0	3.7	2.5	2.3	2.0	1.6
22.0	3.7	2.7	2.0	1.8	1.5	1.3
33.0	3.0	2.1	1.6	1.4	1.2	
47.0	2.0	1.7	1.3	1.2		
68.0	1.8	1.3	1.0			
100.0	1.6	1.0				
150.0	0.9					

age is related to the ESR of power dissipation capabilities size. Thermal capacities for them have been determined and below. For additional description

• ENVIRONMENTAL CONSIDERATIONS

Case Size	W
C	.0
D	.0
E	.0
F	.0

Maximum Power Dissipation C

- A. Shock Test: MIL-STD-202 Condition 1.
 - B. Thermal Shock, MIL-STD-202
 - C. Moisture Resistance: MIL-STD-202 Method 106.
 - D. Solderability: MIL-STD-202
- For additional Environmental Test Information, see pages 80, 81 and 82.

- **LEAD MATERIAL:** Solderable, MIL-STD1266, type N32.
- **LEAD TAPE and REEL:** Reelable, MIL-STD-883C, Method RS-468. See pages 72 and 73 for additional information.

Leads Lengths
Both
.350±.050
(8.89±1.27)

(+)

INDUSTRIAL PRODUCT

MILITARY

T370

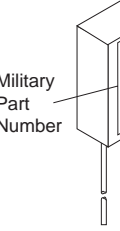
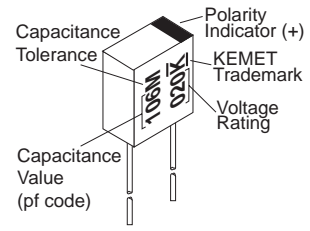

ORDERING INFORMATION KEMET PART NUMBER

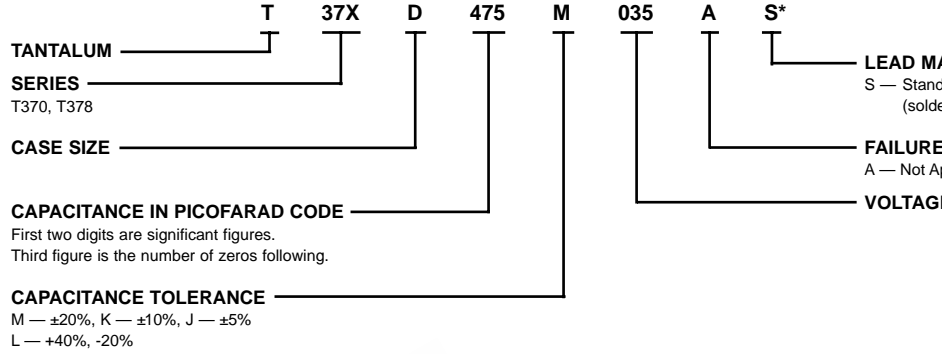

***Part Number Example: T370D475M035AS (14 digits – no spaces)**

MIL-C-49137/6 PART NUMBER CX06(T378) STYLE

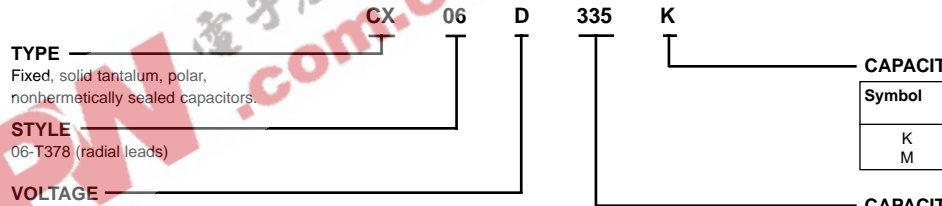

Symbol	Rated (85°C) Volts, dc	Surge (85°C) Volts, dc
A	2	2.6
B	3	4
C	4	5
D	6	8
F	10	13
H	15	20
J	20	26
K	25	32
M	35	46

KEMET Electronics Corporation, P.O. Box 5928, Greenville, S.C. 29606 (864) 963-6300

10.0	C	T370C106(1)006AS			1.0
33.0	D	T370D336(1)006AS	CX06D336(2)	T378D336(3)006AS	2.0
47.0	E	T370E476(1)006AS	CX06D476(2)	T378E476(3)006AS	3.0
150.0	F	T370F157(1)006AS	CX06D157(2)	T378F157(3)006AS	9.0
10 VOLT RATING AT 85°C—7.0 VOLT RATING AT 125°C					
6.8	C	T370C685(1)010AS			1.0
22.0	D	T370D226(1)010AS	CX06F226(2)	T378D226(3)010AS	2.0
33.0	E	T370E336(1)010AS	CX06F336(2)	T378E336(3)010AS	3.0
100.0	F	T370F107(1)010AS	CX06F107(2)	T378F107(3)010AS	9.0
15 VOLT RATING AT 85°C—10 VOLT RATING AT 125°C					
15.0	D	T370D156(1)015AS	CX06H156(2)	T378D156(3)015AS	2.0
22.0	E	T370E226(1)015AS	CX06H226(2)	T378E226(3)015AS	3.0
68.0	F	T370F686(1)015AS	CX06H686(2)	T378F686(3)015AS	9.0
20 VOLT RATING AT 85°C—13 VOLT RATING AT 125°C					
3.3	C	T370C335(1)020AS			1.0
4.7	C	T370C475(1)020AS			1.0
10.0	D	T370D106(1)020AS	CX06J106(2)	T378D106(3)020AS	2.0
15.0	E	T370E156(1)020AS	CX06J156(2)	T378E156(3)020AS	3.0
47.0	F	T370F476(1)020AS	CX06J476(2)	T378F476(3)020AS	9.0
25 VOLT RATING AT 85°C—17 VOLT RATING AT 125°C					
2.2	C	T370C225(1)025AS			1.0
6.8	D	T370D685(1)025AS	CX06K685(2)	T378D685(3)025AS	2.0
10.0	E	T370E106(1)025AS	CX06K106(2)	T378E106(3)025AS	3.0
33.0	F	T370F336(1)025AS	CX06K336(2)	T378F336(3)025AS	9.0
35 VOLT RATING AT 85°C—23 VOLT RATING AT 125°C					
0.68	C	T370C684(1)035AS			1.0
1.0	C	T370C105(1)035AS			1.0
1.5	C	T370C155(1)035AS			1.0
2.2	D	T370D225(1)035AS	CX06M225(2)	T378D225(3)035AS	2.0
3.3	D	T370D335(1)035AS	CX06M335(2)	T378D335(3)035AS	2.0
4.7	D	T370D475(1)035AS	CX06M475(2)	T378D475(3)035AS	2.0
6.8	E	T370E685(1)035AS	CX06M685(2)	T378E685(3)035AS	3.0
10.0	F	T370F106(1)035AS	CX06M106(2)	T378F106(3)035AS	9.0
15.0	F	T370F156(1)035AS	CX06M156(2)	T378F156(3)035AS	9.0
22.0	F	T370F226(1)035AS	CX06M226(2)	T378F226(3)035AS	9.0

(1) To complete KEMET part number, insert capacitance tolerance symbol as follows: L = $\pm 40\%$, -20%; M = $\pm 20\%$; K = $\pm 10\%$; J = $\pm 5\%$.

(2) To complete military part number, insert capacitance tolerance symbol as follows: M = $\pm 20\%$; K = $\pm 10\%$.

(3) To complete KEMET part number, insert capacitance tolerance symbol as follows: M = $\pm 20\%$; K = $\pm 10\%$.

EEPW.com

- **DISSIPATION FACTOR:** Maximum DF limits are shown in corresponding series part number listings. See Application Notes Section, page 76 for additional information.
- **DC LEAKAGE CURRENT:** Maximum leakage values at 25° are shown in part number listings, pages 63-65, 67, 68 and 70. See Application Notes Section, pages 76 & 77 for additional information.
- **RATED VOLTAGE; WORKING VOLTAGE; SURGE VOLTAGE; REVERSE VOLTAGE:** See Application Notes Section, pages 76 & 77 for description.
- **IMPEDANCE and ESR:** See Application Notes Section, page 77 & 78 for description. Reference ESR values are shown in table below.

Size	(max.)
T35X, A	
T39X B	
C	
D	
E	
F	
G	
H	
J	
K	
L	
M	
T36X A	
B	
C	
D	

Maximum Power Dissipation C

- **ENVIRONMENTAL CONSIDERATIONS:**
 - A. Shock Test: MIL-STD-202.
 - B. Thermal Shock, MIL-STD-202 Condition A.
 - C. Moisture Resistance: MIL-STD-202 Method 106.
 - D. Solderability: MIL-STD-202 Method 208. For additional Environmental Test Information see pages 80, 81 and 82.
- **LEAD MATERIAL:** Solder coated copper ply per MIL-STD-127.
- **LEAD TAPE and REEL:** See Application Note RS-468. See pages 72 - 74 for additional information.

Commercial T35X/T36X/T39X ESR (OHMS) at 100 kHz @ +25°C
 (The ESR values provided below are for reference only. No warranty, as stated on page 3 and reincorporated here, is made as to the accuracy of these values for any particular T35X, T36X, T39X Series product.)

Cap. μ F	6 Volt	10 Volt	16 Volt	20 Volt	25 Volt	35 Volt	50 Volt
0.10						26.0	26.0
0.15						21.0	21.0
0.22						17.0	17.0
0.33						15.0	15.0
0.47						13.0	13.0
0.68						10.0	10.0
1.00				10.0	10.0	8.0	8.0
1.50			10.0	9.0	8.0	6.0	5.0
2.20		13.0	8.0	7.0	6.0	5.0	3.5
3.30	13.0	10.0	6.0	5.5	5.0	4.0	3.0
4.70	10.0	8.0	5.0	4.5	4.0	3.0	2.5
6.80	8.0	6.0	4.0	3.6	3.1	2.5	2.0
10.0	6.0	5.0	3.2	2.9	2.5	2.0	1.6
15.0	5.0	3.7	2.5	2.3	2.0	1.6	1.2
22.0	3.7	2.7	2.0	1.8	1.5	1.3	1.0
33.0	3.0	2.1	1.6	1.4	1.2	1.0	
47.0	2.0	1.7	1.3	1.2	1.0	0.8	
68.0	1.8	1.3	1.0	0.9	0.8		
100.0	1.6	1.0	0.8	0.6			
150.0	0.9	0.8	0.6				
220.0	0.9	0.6					
330.0	0.7						

CAPACITOR OUTLINE DRAWINGS

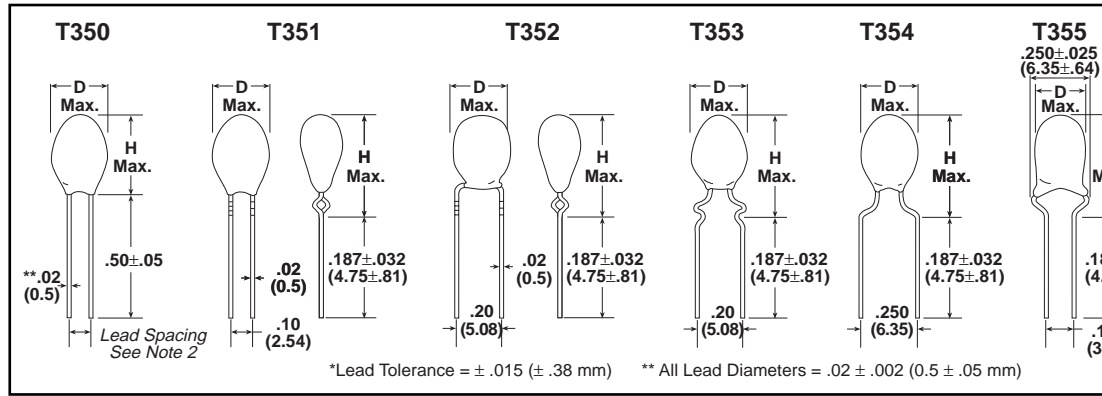

DIMENSIONS — INCHES (MILLIMETERS)

Case Size	All	T350	T351	T352	T353	T354	T355
	D Max Diameter	H ⁽¹⁾ Max Height	H ⁽¹⁾ Max Height	H ⁽¹⁾ Max Height	H ⁽¹⁾ Max Height	H ⁽¹⁾ Max Height	H ⁽¹⁾ Max Height
A	.175 (4.5)	.280 (7.1)	.380 (9.6)	.400 (10.2)	.400 (10.2)	.340 (8.6)	.340 (8.6)
B	.175 (4.5)	.300 (7.6)	.390 (9.9)	.410 (10.4)	.410 (10.4)	.350 (8.9)	.350 (8.9)
C	.196 (5.0)	.330 (8.4)	.420 (10.7)	.440 (11.2)	.440 (11.2)	.380 (9.6)	.380 (9.6)
D	.196 (5.0)	.340 (8.6)	.430 (10.9)	.450 (11.4)	.450 (11.4)	.390 (9.9)	.390 (9.9)
E	.216 (5.5)	.350 (8.9)	.440 (11.2)	.460 (11.7)	.460 (11.7)	.400 (10.2)	.400 (10.2)
F	.236 (6.0)	.390 (9.9)	.480 (12.2)	.500 (12.7)	.500 (12.7)	.440 (11.2)	.440 (11.2)
G	.250 (6.3)	.400 (10.2)	.490 (12.4)	.510 (13.0)	.510 (13.0)	.450 (11.4)	.450 (11.4)
H	.300 (7.6)	.400 (10.2)	.500 (12.7)	.520 (13.2)	.520 (13.2)	.470 (11.9)	.470 (11.9)
J ⁽²⁾	.330 (8.4)	.500 (12.7)	Note 3	Note 3	.580 (14.7)	.550 (14.0)	Note 3
K ⁽²⁾	.350 (8.9)	.530 (13.5)			.630 (16.0)	.610 (15.5)	
L ⁽²⁾	.350 (8.9)	.630 (16.0)			.730 (18.5)	.710 (18.1)	
M ⁽²⁾	.400 (10.2)	.670 (17.0)			.760 (19.3)	.740 (18.8)	

NOTES: (1) All "H" Dimensions are from Capacitor seating plane to top of Capacitor.
 (2) On T350 Series, case sizes A-H are supplied with .100" (2.54) lead spacing—case sizes J-M are supplied with .200" (5.08).
 (3) These case sizes are not available for T351, T352 & T355 capacitors.

LEAD CONFIGURATION & SPACING CHART

CASE	LEAD CONFIGURATION	SERIES						
		T350	T351	T352	T353	T354	T355	T356
A-H	.100	X	X					
	.125						X	
	.200			X	X			X
	.250					X		
	STRAIGHT LEAD	X						
STAND OFF		X	X		X	X	X	
SNAP-IN					X			
J-M	.100		"NOT AVAILABLE"	"NOT AVAILABLE"			"NOT AVAILABLE"	
	.125							
	.200	X			X			X
	.250					X		
	STRAIGHT LEAD	X						
STAND OFF					X		X	
SNAP-IN				X				

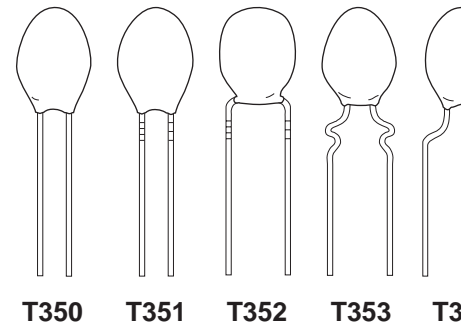

First two digits are significant figures. Third figure is the number of zeros following.

K — ±10%
J — ±5% A
*T363 & T364 available

***Part Number Example: T350A105M035AS (14 digits – no spaces)**

**T35X & T368
MARKING INFORMATION**

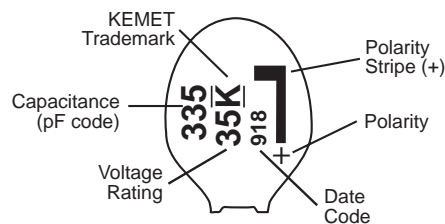

**T35X
RATINGS AND PART NUMBER REFERENCE**

CAPACITANCE μF	CASE SIZE	KEMET PART NUMBER	D.C. LEAKAGE μA@25°C	MAX. DISSIPATION FACTOR %@25°C, 120Hz
3 VOLT RATING AT 85°C — 2 VOLT RATING AT 125°C				
4.7	A	T35(1)A475(3)003AS	0.5	5
5.6	A	T35(1)A565(3)003AS	0.5	5
6.8	A	T35(1)A685(3)003AS	0.5	5
8.2	A	T35(1)A825(3)003AS	0.5	6
10.0	A	T35(1)A106(3)003AS	0.5	6
12.0	B	T35(1)B126(3)003AS	0.5	6
15.0	B	T35(1)B156(3)003AS	0.5	6
18.0	C	T35(1)C186(3)003AS	0.5	6
22.0	C	T35(1)C226(3)003AS	0.5	6
27.0	D	T35(1)D276(3)003AS	0.6	6
33.0	D	T35(1)D336(3)003AS	0.8	6
39.0	E	T35(1)E396(3)003AS	0.9	6
47.0	E	T35(1)E476(3)003AS	1.1	6
56.0	F	T35(1)F566(3)003AS	1.3	6
68.0	F	T35(1)F686(3)003AS	1.6	6
82.0	G	T35(1)G826(3)003AS	2.0	8
100.0	G	T35(1)G107(3)003AS	2.4	8
120.0	H	T35(1)H127(3)003AS	2.9	8
150.0	H	T35(1)H157(3)003AS	3.6	8
180.0	J	T35(2)J187(3)003AS	4.3	8
220.0	J	T35(2)J227(3)003AS	5.3	8
270.0	K	T35(2)K277(3)003AS	6.5	8
330.0	K	T35(2)K337(3)003AS	7.9	8
390.0	L	T35(2)L397(3)003AS	9.4	9
470.0	L	T35(2)L477(3)003AS	10.0	9
560.0	M	T35(2)M567(3)003AS	10.0	9
680.0	M	T35(2)M687(3)003AS	10.0	9

CAPACITANCE μF	CASE SIZE	KEMET PART NUMBER
6.3 VOLT RATING AT 85°C — 4 VOLT RATING AT 125°C		
3.3	A	T35(1)A335(3)006AS
3.9	A	T35(1)A395(3)006AS
4.7	A	T35(1)A475(3)006AS
5.6	A	T35(1)A565(3)006AS
6.8	A	T35(1)A685(3)006AS
8.2	B	T35(1)B825(3)006AS
10.0	B	T35(1)B106(3)006AS
12.0	C	T35(1)C126(3)006AS
15.0	C	T35(1)C156(3)006AS
18.0	D	T35(1)D186(3)006AS
22.0	D	T35(1)D226(3)006AS
27.0	E	T35(1)E276(3)006AS
33.0	E	T35(1)E336(3)006AS
39.0	F	T35(1)F396(3)006AS
47.0	F	T35(1)F476(3)006AS
56.0	G	T35(1)G566(3)006AS
68.0	G	T35(1)G686(3)006AS
82.0	H	T35(1)H826(3)006AS
100.0	H	T35(1)H107(3)006AS
120.0	J	T35(2)J127(3)006AS
150.0	J	T35(2)J157(3)006AS
180.0	K	T35(2)K187(3)006AS
220.0	K	T35(2)K227(3)006AS
270.0	L	T35(2)L277(3)006AS
330.0	L	T35(2)L337(3)006AS

- (1) To complete KEMET Part Number, insert Series Designation as follows: "0" = T350, "1" = T351, "2" = T352, "3" = T353, "4" = T354, "5" = T355, "6" = T356.
- (2) To complete KEMET Part Number, insert only Series Designation as follows: "0" = T350, "3" = T353, "4" = T354, "6" = T356.
- (3) To complete KEMET Part Number, insert Capacitance Tolerance Symbol: "M" = ±20%, "K" = ±10%.

Bold Face print indicates popular values.

NOTE: Higher voltage and better capacitance tolerance product may be substituted for an order within the same case size at KEMET's option.

KEMET Electronics Corporation, P.O. Box 5928, Greenville, S.C. 29606 (864) 963-6300

3.9	A	T35(1)A395(3)010AS	0.5	5
4.7	A	T35(1)A475(3)010AS	0.5	5
5.6	B	T35(1)B565(3)010AS	0.5	5
6.8	B	T35(1)B685(3)010AS	0.5	5
8.2	C	T35(1)C825(3)010AS	0.7	6
10.0	C	T35(1)C106(3)010AS	0.8	6
12.0	E	T35(1)E126(3)010AS	1.0	6
15.0	E	T35(1)E156(3)010AS	1.2	6
18.0	E	T35(1)E186(3)010AS	1.4	6
22.0	E	T35(1)E226(3)010AS	1.8	6
27.0	F	T35(1)F276(3)010AS	2.2	6
33.0	F	T35(1)F336(3)010AS	2.6	6
39.0	G	T35(1)G396(3)010AS	3.1	6
47.0	H	T35(1)H476(3)010AS	3.8	6
56.0	H	T35(1)H566(3)010AS	4.5	6
68.0	H	T35(1)H686(3)010AS	5.4	6
82.0	J	T35(2)J826(3)010AS	6.6	8
100.0	J	T35(2)J107(3)010AS	8.0	8
120.0	K	T35(2)K127(3)010AS	9.6	8
150.0	K	T35(2)K157(3)010AS	10.0	8
180.0	L	T35(2)L187(3)010AS	10.0	8
220.0	L	T35(2)L227(3)010AS	10.0	8
16 VOLT RATING AT 85°C — 10 VOLT RATING AT 125°C				
1.5	A	T35(1)A155(3)016AS	0.5	5
1.8	A	T35(1)A185(3)016AS	0.5	5
2.2	A	T35(1)A225(3)016AS	0.5	5
2.7	A	T35(1)A275(3)016AS	0.5	5
3.3	A	T35(1)A335(3)016AS	0.5	5
3.9	B	T35(1)B395(3)016AS	0.5	5
4.7	B	T35(1)B475(3)016AS	0.6	5
5.6	C	T35(1)C565(3)016AS	0.7	5
6.8	C	T35(1)C685(3)016AS	0.9	5
8.2	E	T35(1)E825(3)016AS	1.0	6
10.0	E	T35(1)E106(3)016AS	1.3	6
12.0	E	T35(1)E126(3)016AS	1.5	6
15.0	E	T35(1)E156(3)016AS	1.8	6
18.0	F	T35(1)F186(3)016AS	2.2	6
22.0	F	T35(1)F226(3)016AS	2.6	6
27.0	H	T35(1)H276(3)016AS	3.2	6
33.0	H	T35(1)H336(3)016AS	4.0	6
39.0	J	T35(2)J396(3)016AS	4.7	6
47.0	J	T35(2)J476(3)016AS	5.6	6
56.0	K	T35(2)K566(3)016AS	6.8	6
68.0	K	T35(2)K686(3)016AS	8.2	6
82.0	L	T35(2)L826(3)016AS	9.8	8
100.0	L	T35(2)L107(3)016AS	10.0	8
120.0	M	T35(2)M127(3)016AS	10.0	8
150.0	M	T35(2)M157(3)016AS	10.0	8

1.8	A	T35(1)A185(3)020A
2.2	A	T35(1)A225(3)020A
2.7	B	T35(1)B275(3)020A
3.3	B	T35(1)B335(3)020A
3.9	C	T35(1)C395(3)020A
4.7	C	T35(1)C475(3)020A
5.6	D	T35(1)D565(3)020A
6.8	D	T35(1)D685(3)020A
8.2	E	T35(1)E825(3)020A
10.0	E	T35(1)E106(3)020A
12.0	F	T35(1)F126(3)020A
15.0	F	T35(1)F156(3)020A
18.0	G	T35(1)G186(3)020A
22.0	G	T35(1)G226(3)020A
27.0	J	T35(2)J276(3)020A
33.0	J	T35(2)J336(3)020A
39.0	K	T35(2)K396(3)020A
47.0	K	T35(2)K476(3)020A
56.0	L	T35(2)L566(3)020A
68.0	L	T35(2)L686(3)020A
82.0	M	T35(2)M826(3)020A
100.0	M	T35(2)M107(3)020A
25 VOLT RATING AT 85°C — 16.5 VOLT RATING AT 125°C		
1.0	A	T35(1)A105(3)025A
1.2	A	T35(1)A125(3)025A
1.5	A	T35(1)A155(3)025A
1.8	A	T35(1)A185(3)025A
2.2	B	T35(1)B225(3)025A
2.7	B	T35(1)B275(3)025A
3.3	B	T35(1)B335(3)025A
3.9	C	T35(1)C395(3)025A
4.7	C	T35(1)C475(3)025A
5.6	E	T35(1)E565(3)025A
6.8	E	T35(1)E685(3)025A
8.2	E	T35(1)E825(3)025A
10.0	E	T35(1)E106(3)025A
12.0	G	T35(1)G126(3)025A
15.0	G	T35(1)G156(3)025A
18.0	H	T35(1)H186(3)025A
22.0	H	T35(1)H226(3)025A
27.0	J	T35(2)J276(3)025A
33.0	J	T35(2)J336(3)025A
39.0	K	T35(2)K396(3)025A
47.0	K	T35(2)K476(3)025A
56.0	L	T35(2)L566(3)025A
68.0	L	T35(2)L686(3)025A

(1) To complete KEMET Part Number, insert Series Designation as follows: "0" = T350, "1" = T351, "2" = T352, "3" = T353, "4" = T354, "5" = T355, "6" = T356.

(2) To complete KEMET Part Number, insert only Series Designation as follows: "0" = T350, "3" = T353, "4" = T354, "6" = T356.

(3) To complete KEMET Part Number, insert Capacitance Tolerance Symbol: "M" = ±20%, "K" = ±10%.

Bold Face print indicates popular values.

NOTE: Higher voltage and better capacitance tolerance product may be substituted for an order within the same case size at KEMET's option.

0.18	A	T35(1)A184(3)035AS	0.5	3
0.22	A	T35(1)A224(3)035AS	0.5	3
0.27	A	T35(1)A274(3)035AS	0.5	3
0.33	A	T35(1)A334(3)035AS	0.5	3
0.39	A	T35(1)A394(3)035AS	0.5	3
0.47	A	T35(1)A474(3)035AS	0.5	3
0.56	A	T35(1)A564(3)035AS	0.5	3
0.68	A	T35(1)A684(3)035AS	0.5	3
0.82	A	T35(1)A824(3)035AS	0.5	3
1.0	A	T35(1)A105(3)035AS	0.5	3
1.2	B	T35(1)B125(3)035AS	0.5	5
1.5	B	T35(1)B155(3)035AS	0.5	5
1.8	C	T35(1)C185(3)035AS	0.5	5
2.2	C	T35(1)C225(3)035AS	0.6	5
2.7	D	T35(1)D275(3)035AS	0.7	5
3.3	D	T35(1)D335(3)035AS	0.9	5
3.9	E	T35(1)E395(3)035AS	1.0	5
4.7	E	T35(1)E475(3)035AS	1.3	5
5.6	F	T35(1)F565(3)035AS	1.6	5
6.8	F	T35(1)F685(3)035AS	1.9	5
8.2	G	T35(1)G825(3)035AS	2.3	6
10.0	G	T35(1)G106(3)035AS	2.8	6
12.0	J	T35(2)J126(3)035AS	3.4	6
15.0	J	T35(2)J156(3)035AS	4.2	6
18.0	K	T35(2)K186(3)035AS	5.0	6
22.0	K	T35(2)K226(3)035AS	6.2	6
27.0	L	T35(2)L276(3)035AS	7.6	6
33.0	L	T35(2)L336(3)035AS	9.2	6
39.0	M	T35(2)M396(3)035AS	10.0	6
47.0	M	T35(2)M476(3)035AS	10.0	6

0.18	A	T35(1)A184(3)050A
0.22	A	T35(1)A224(3)050A
0.27	A	T35(1)A274(3)050A
0.33	A	T35(1)A334(3)050A
0.39	B	T35(1)B394(3)050A
0.47	B	T35(1)B474(3)050A
0.56	B	T35(1)B564(3)050A
0.68	B	T35(1)B684(3)050A
0.82	B	T35(1)B824(3)050A
1.0	B	T35(1)B105(3)050A
1.2	D	T35(1)D125(3)050A
1.5	E	T35(1)E155(3)050A
1.8	E	T35(1)E185(3)050A
2.2	E	T35(1)E225(3)050A
2.7	F	T35(1)F275(3)050A
3.3	F	T35(1)F335(3)050A
3.9	G	T35(1)G395(3)050A
4.7	G	T35(1)G475(3)050A
5.6	H	T35(1)H565(3)050A
6.8	J	T35(2)J685(3)050A
8.2	J	T35(2)J825(3)050A
10.0	K	T35(2)K106(3)050A
12.0	K	T35(2)K126(3)050A
15.0	L	T35(2)L156(3)050A
18.0	L	T35(2)L186(3)050A
22.0	M	T35(2)M226(3)050A

(1) To complete KEMET Part Number, insert Series Designation as follows: "0" = T350, "1" = T351, "2" = T352, "3" = T353, "4" = T354, "5" = T355, "6" = T356.

(2) To complete KEMET Part Number, insert only Series Designation as follows: "0" = T350, "3" = T353, "4" = T354, "6" = T356.

(3) To complete KEMET Part Number, insert Capacitance Tolerance Symbol: "M" = $\pm 20\%$, "K" = $\pm 10\%$.

Bold Face print indicates popular values.

NOTE: Higher voltage and better capacitance tolerance product may be substituted for an order within the same case size at KEMET's option.

EEPW 电子產品世界
EEPW.com.cn

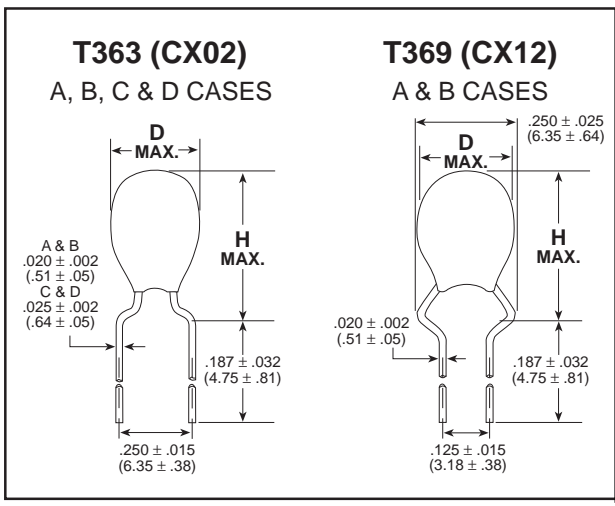

T363 A-D CASES
T369 A & B CASES

CASE SIZE	D MAX
A	0.175 (4.45)
B	0.250 (6.35)
C	0.350 (8.89)
D	0.400 (10.16)

MIL-C-49137 MARKING INFORMATION

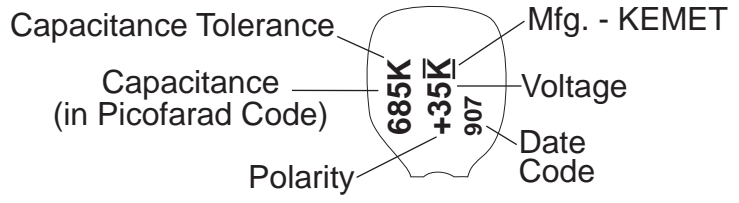

MIL-C-49137/2 ORDERING INFORMATION

TYPE _____ CX 02 D
 Capacitors, Fixed, Solid Tantalum
 Conformal Coated, Non-hermetically Sealed.

STYLE _____
 02 (T363) A, B, C & D Cases
 12 (T369) A & B Cases Only

VOLTAGE _____

Symbol	Rated (857C) Volts, dc	Surge (857C) Volts, dc
D	6	8
F	10	13
H	15	20
J	20	26
K	25	32
M	35	46
N	50	65

*For KEMET Ordering Information, see page 63.

CAPACITANCE _____

Symbol
K
M

CAPACITANCE _____
 The nominal capacitance in picofarads (pF), is the first two digits and the last digit specifies the multiplier.

330.0	D	10, 20	T363D337(2)006AS	10.0	8	CX02D337(2)
10 VOLT RATING AT 85°C						
4.7	A	10, 20	T36(1)A475(2)010AS	0.5	5	CX02F475(2)
33.0	B	10, 20	T36(1)B336(2)010AS	2.6	6	CX02F336(2)
100.0	C	10, 20	T363C107(2)010AS	8.0	8	CX02F107(2)
220.0	D	10, 20	T363D227(2)010AS	10.0	8	CX02F227(2)
15 VOLT RATING AT 85°C						
3.3	A	10, 20	T36(1)A335(2)015AS	0.5	5	CX02H335(2)
22.0	B	10, 20	T36(1)B226(2)015AS	2.6	6	CX02H226(2)
68.0	C	10, 20	T363C686(2)015AS	8.2	6	CX02H686(2)
150.0	D	10, 20	T363D157(2)015AS	10.0	8	CX02H157(2)
20 VOLT RATING AT 85°C						
2.2	A	10, 20	T36(1)A225(2)020AS	0.5	5	CX02J225(2)
15.0	B	10, 20	T36(1)B156(2)020AS	2.4	6	CX02J156(2)
47.0	C	10, 20	T363C476(2)020AS	7.5	6	CX02J476(2)
100.0	D	10, 20	T363D107(2)020AS	10.0	8	CX02J107(2)
25 VOLT RATING AT 85°C						
1.5	A	10, 20	T36(1)A155(2)025AS	0.5	5	CX02K155(2)
10.0	B	10, 20	T36(1)B106(2)025AS	2.0	6	CX02K106(2)
33.0	C	10, 20	T363C336(2)025AS	6.6	6	CX02K336(2)
68.0	D	10, 20	T363D686(2)025AS	10.0	6	CX02K686(2)
35 VOLT RATING AT 85°C						
6.8	B	10, 20	T36(1)B685(2)035AS	1.9	5	CX02M685(2)
22.0	C	10, 20	T363C226(2)035AS	6.2	6	CX02M226(2)
33.0	D	10, 20	T363D336(2)035AS	9.2	6	CX02M336(2)
47.0	D	10, 20	T363D476(2)035AS	10.0	6	CX02M476(2)
50 VOLT RATING AT 85°C						
0.1	A	10, 20	T36(1)A104(2)050AS	0.5	3	CX02N104(2)
0.15	A	10, 20	T36(1)A154(2)050AS	0.5	3	CX02N154(2)
0.22	A	10, 20	T36(1)A224(2)050AS	0.5	3	CX02N224(2)
0.33	A	10, 20	T36(1)A334(2)050AS	0.5	3	CX02N334(2)
0.47	A	10, 20	T36(1)A474(2)050AS	0.5	3	CX02N474(2)
0.68	A	10, 20	T36(1)A684(2)050AS	0.5	3	CX02N684(2)
1.0	A	10, 20	T36(1)A105(2)050AS	0.5	3	CX02N105(2)
1.5	B	10, 20	T36(1)B155(2)050AS	0.6	5	CX02N155(2)
2.2	B	10, 20	T36(1)B225(2)050AS	0.9	5	CX02N225(2)
3.3	B	10, 20	T36(1)B335(2)050AS	1.3	5	CX02N335(2)
4.7	B	10, 20	T36(1)B475(2)050AS	1.9	5	CX02N475(2)
6.8	C	10, 20	T363C685(2)050AS	2.7	5	CX02N685(2)
10.0	C	10, 20	T363C106(2)050AS	4.0	6	CX02N106(2)
15.0	C	10, 20	T363C156(2)050AS	6.0	6	CX02N156(2)
22.0	D	10, 20	T363D226(2)050AS	8.8	6	CX02N226(2)

(1) To complete KEMET part number, insert Series Designation as follows: 3 - T363 (CX02); 9 - T369 (CX12)
(2) To complete KEMET or military part number, insert Capacitance Tolerance Symbol as follows:
M - $\pm 20\%$, K - $\pm 10\%$

RATINGS AND PART NUMBER REFERENCE

CAPACITANCE μF	CASE SIZE	KEMET PART NUMBER	D.C. LEAKAGE μA@25°C	MAX. DISSI- PATION FACTOR %@25°C, 120Hz
6 VOLT RATING AT 85°C				
82.0	C	T368C826(1)006AS	3.9	8
100.0	C	T368C107(1)006AS	4.8	8
120.0	C	T368C127(1)006AS	5.8	8
150.0	C	T368C157(1)006AS	7.2	8
180.0	D	T368D187(1)006AS	8.6	8
220.0	D	T368D227(1)006AS	10.0	8
270.0	D	T368D277(1)006AS	10.0	8
330.0	D	T368D337(1)006AS	10.0	8
10 VOLT RATING AT 85°C				
47.0	C	T368C476(1)010AS	3.8	6
56.0	C	T368C566(1)010AS	4.4	6
68.0	C	T368C686(1)010AS	5.4	6
82.0	C	T368C826(1)010AS	6.5	8
100.0	C	T368C107(1)010AS	8.0	8
120.0	D	T368D127(1)010AS	9.6	8
150.0	D	T368D157(1)010AS	10.0	8
180.0	D	T368D187(1)010AS	10.0	8
220.0	D	T368D227(1)010AS	10.0	8
15 VOLT RATING AT 85°C				
27.0	C	T368C276(1)015AS	3.2	6
33.0	C	T368C336(1)015AS	4.0	6
39.0	C	T368C396(1)015AS	4.7	6
47.0	C	T368C476(1)015AS	5.6	6
56.0	C	T368C566(1)015AS	6.8	6
68.0	C	T368C686(1)015AS	8.2	6
82.0	D	T368D826(1)015AS	9.8	8
100.0	D	T368D107(1)015AS	10.0	8
120.0	D	T368D127(1)015AS	10.0	8
150.0	D	T368D157(1)015AS	10.0	8
20 VOLT RATING AT 85°C				
18.0	C	T368C186(1)020AS	2.8	6
22.0	C	T368C226(1)020AS	3.5	6
27.0	C	T368C276(1)020AS	4.3	6
33.0	C	T368C336(1)020AS	5.3	6
39.0	C	T368C396(1)020AS	6.2	6
47.0	C	T368C476(1)020AS	7.5	6
56.0	D	T368D566(1)020AS	8.9	6
68.0	D	T368D686(1)020AS	10.0	6
82.0	D	T368D826(1)020AS	10.0	8
100.0	D	T368D107(1)020AS	10.0	8

CAPACITANCE μF	CASE SIZE	KEMET PART NUMBER
25 VOLT RATING AT 85°C		
12.0	C	T368C126(1)025AS
15.0	C	T368C156(1)025AS
18.0	C	T368C186(1)025AS
22.0	C	T368C226(1)025AS
27.0	C	T368C276(1)025AS
33.0	C	T368C336(1)025AS
39.0	D	T368D396(1)025AS
47.0	D	T368D476(1)025AS
56.0	D	T368D566(1)025AS
68.0	D	T368D686(1)025AS
35 VOLT RATING AT 85°C		
8.2	C	T368C825(1)035AS
10.0	C	T368C106(1)035AS
12.0	C	T368C126(1)035AS
15.0	C	T368C156(1)035AS
18.0	C	T368C186(1)035AS
22.0	C	T368C226(1)035AS
27.0	D	T368D276(1)035AS
33.0	D	T368D336(1)035AS
39.0	D	T368D396(1)035AS
47.0	D	T368D476(1)035AS
50 VOLT RATING AT 85°C		
5.6	C	T368C565(1)050AS
6.8	C	T368C685(1)050AS
8.2	C	T368C825(1)050AS
10.0	C	T368C106(1)050AS
12.0	C	T368C126(1)050AS
15.0	C	T368C156(1)050AS
18.0	D	T368D186(1)050AS
22.0	D	T368D226(1)050AS

(1) To complete KEMET part number, insert capacitance tolerance or J- +5% (Available on special order).

* For Marking Information refer to T368 Marking Information

* For Ordering Information refer to T368 Ordering Information

CAPACITOR OUTLINE DRAWING

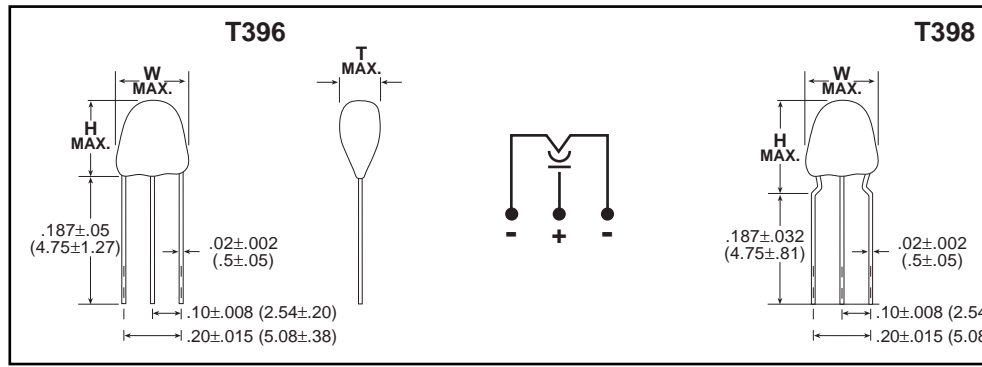

DIMENSIONS—INCHES & (MILLIMETERS)

Series	Case Size	Both		T396	T398
		W Width	T Thickness	H* Height	H* Height
T396/T398	A	.280 (7.1)	.190 (4.8)	.310 (7.9)	.355 (9.0)
T396/T398	B	.280 (7.1)	.190 (4.8)	.320 (8.1)	.365 (9.3)
T396/T398	C	.280 (7.1)	.200 (5.1)	.360 (9.1)	.390 (9.9)
T396/T398	D	.280 (7.1)	.200 (5.1)	.370 (9.4)	.390 (9.9)
T396/T398	E	.280 (7.1)	.230 (5.8)	.380 (9.7)	.415 (10.5)
T396/T398	F	.280 (7.1)	.240 (6.1)	.410 (10.4)	.430 (10.9)
T396/T398	G	.280 (7.1)	.250 (6.3)	.420 (10.7)	.440 (11.2)
T396/T398	H	.280 (7.1)	.270 (6.9)	.420 (10.7)	.440 (11.2)
T396/T398	J	.300 (7.6)	.300 (7.6)	.460 (11.7)	.480 (12.2)
T396/T398	K	.340 (8.6)	.340 (8.6)	.500 (12.7)	.500 (12.7)
T396/T398	L	.340 (8.6)	.340 (8.6)	.560 (14.2)	.580 (14.7)
T396/T398	M	.360 (9.1)	.360 (9.1)	.620 (15.7)	.620 (15.7)

*NOTE: "H" dimensions are from seating plane to top of capacitor.

ORDERING INFORMATION

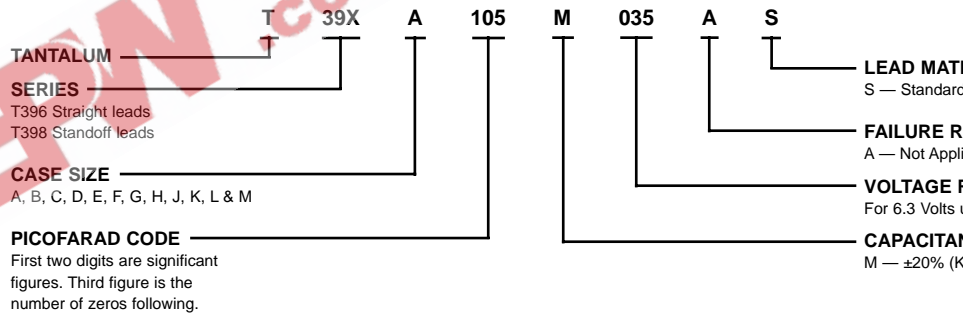

KEMET Electronics Corporation, P.O. Box 5928, Greenville, S.C. 29606 (864) 963-6300

22.0	C	T39(1)C226(2)003AS	0.5	6
33.0	D	T39(1)D336(2)003AS	0.8	6
47.0	E	T39(1)E476(2)003AS	1.1	6
68.0	F	T39(1)F686(2)003AS	1.6	6
100.0	G	T39(1)G107(2)003AS	2.4	8
150.0	H	T39(1)H157(2)003AS	3.6	8
220.0	J	T39(1)J227(2)003AS	5.3	8
330.0	K	T39(1)K337(2)003AS	7.9	8
470.0	L	T39(1)L477(2)003AS	10.0	9
680.0	M	T39(1)M687(2)003AS	10.0	9
10 VOLT RATING AT 85°C — 7 VOLT RATING AT 125°C				
2.2	A	T39(1)A225(2)010AS	0.5	5
3.3	A	T39(1)A335(2)010AS	0.5	5
4.7	A	T39(1)A475(2)010AS	0.5	5
6.8	B	T39(1)B685(2)010AS	0.5	5
10.0	C	T39(1)C106(2)010AS	0.8	6
15.0	E	T39(1)E156(2)010AS	1.2	6
22.0	E	T39(1)E226(2)010AS	1.8	6
33.0	F	T39(1)F336(2)010AS	2.6	6
47.0	H	T39(1)H476(2)010AS	3.8	6
68.0	H	T39(1)H686(2)010AS	5.4	6
100.0	J	T39(1)J107(2)010AS	8.0	8
150.0	K	T39(1)K157(2)010AS	10.0	8
220.0	I	T39(1)L227(2)010AS	10.0	8
20 VOLT RATING AT 85°C — 13 VOLT RATING AT 125°C				
1.0	A	T39(1)A105(2)020AS	0.5	3
1.5	A	T39(1)A155(2)020AS	0.5	5
2.2	A	T39(1)A225(2)020AS	0.5	5
3.3	B	T39(1)B335(2)020AS	0.5	5
4.7	C	T39(1)C475(2)020AS	0.8	5
6.8	D	T39(1)D685(2)020AS	1.1	5
10.0	E	T39(1)E106(2)020AS	1.6	6
15.0	F	T39(1)F156(2)020AS	2.4	6
22.0	G	T39(1)G226(2)020AS	3.5	6
33.0	J	T39(1)J336(2)020AS	5.3	6
47.0	K	T39(1)K476(2)020AS	7.5	6
68.0	L	T39(1)L686(2)020AS	10.0	6
100.0	M	T39(1)M107(2)020AS	10.0	8
35 VOLT RATING AT 85°C — 23 VOLT RATING AT 125°C				
0.10	A	T39(1)A104(2)035AS	0.5	3
0.15	A	T39(1)A154(2)035AS	0.5	3
0.22	A	T39(1)A224(2)035AS	0.5	3
0.33	A	T39(1)A334(2)035AS	0.5	3
0.47	A	T39(1)A474(2)035AS	0.5	3
0.68	A	T39(1)A684(2)035AS	0.5	3
1.0	A	T39(1)A105(2)035AS	0.5	3
1.5	B	T39(1)B155(2)035AS	0.5	5
2.2	C	T39(1)C225(2)035AS	0.6	5
3.3	D	T39(1)D335(2)035AS	0.9	5
4.7	E	T39(1)E475(2)035AS	1.3	5
6.8	F	T39(1)F685(2)035AS	1.9	5
10.0	G	T39(1)G106(2)035AS	2.8	6
15.0	J	T39(1)J156(2)035AS	4.2	6
22.0	K	T39(1)K226(2)035AS	6.2	6
33.0	L	T39(1)L336(2)035AS	9.2	6
47.0	M	T39(1)M476(2)035AS	10.0	6

15.0	C	T39(1)C156(2)006AS		
22.0	D	T39(1)D226(2)006AS		
33.0	E	T39(1)E336(2)006AS		
47.0	F	T39(1)F476(2)006AS		
68.0	G	T39(1)G686(2)006AS		
100.0	H	T39(1)H107(2)006AS		
150.0	J	T39(1)J157(2)006AS		
220.0	K	T39(1)K227(2)006AS		
330.0	L	T39(1)L337(2)006AS		
16 VOLT RATING AT 85°C — 10 VOLT RATING AT 125°C				
1.5	A	T39(1)A155(2)016AS		
2.2	A	T39(1)A225(2)016AS		
3.3	A	T39(1)A335(2)016AS		
4.7	B	T39(1)B475(2)016AS		
6.8	C	T39(1)C685(2)016AS		
10.0	E	T39(1)E106(2)016AS		
15.0	E	T39(1)E156(2)016AS		
22.0	F	T39(1)F226(2)016AS		
33.0	H	T39(1)H336(2)016AS		
47.0	J	T39(1)J476(2)016AS		
68.0	K	T39(1)K686(2)016AS		
100.0	L	T39(1)L107(2)016AS		
150.0	M	T39(1)M157(2)016AS		
25 VOLT RATING AT 85°C — 16.5 VOLT RATING AT 125°C				
1.0	A	T39(1)A105(2)025AS		
1.5	A	T39(1)A155(2)025AS		
2.2	B	T39(1)B225(2)025AS		
3.3	B	T39(1)B335(2)025AS		
4.7	C	T39(1)C475(2)025AS		
6.8	E	T39(1)E685(2)025AS		
10.0	E	T39(1)E106(2)025AS		
15.0	G	T39(1)G156(2)025AS		
22.0	H	T39(1)H226(2)025AS		
33.0	J	T39(1)J336(2)025AS		
47.0	K	T39(1)K476(2)025AS		
68.0	L	T39(1)L686(2)025AS		
50 VOLT RATING AT 85°C — 33 VOLT RATING AT 125°C				
0.10	A	T39(1)A104(2)050AS		
0.15	A	T39(1)A154(2)050AS		
0.22	A	T39(1)A224(2)050AS		
0.33	A	T39(1)A334(2)050AS		
0.47	B	T39(1)B474(2)050AS		
0.68	B	T39(1)B684(2)050AS		
1.0	B	T39(1)B105(2)050AS		
1.5	E	T39(1)E155(2)050AS		
2.2	E	T39(1)E225(2)050AS		
3.3	F	T39(1)F335(2)050AS		
4.7	G	T39(1)G475(2)050AS		
6.8	J	T39(1)J685(2)050AS		
10.0	K	T39(1)K106(2)050AS		
15.0	L	T39(1)L156(2)050AS		
22.0	M	T39(1)M226(2)050AS		

(1) To complete KEMET Part Number, insert Series Designation as follows: "6" = T396, "8" = T398.

(2) To complete KEMET Part Number, insert Capacitance Tolerance Symbol as follows: "M" = ±20%, "K" = ±10%.

NOTE: Higher voltage/higher tolerance products may be shipped, at KEMET's option, within the same case size.

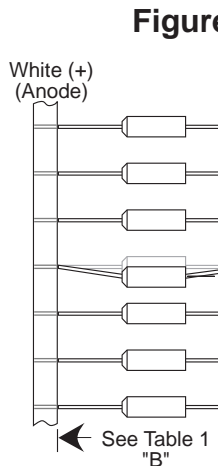
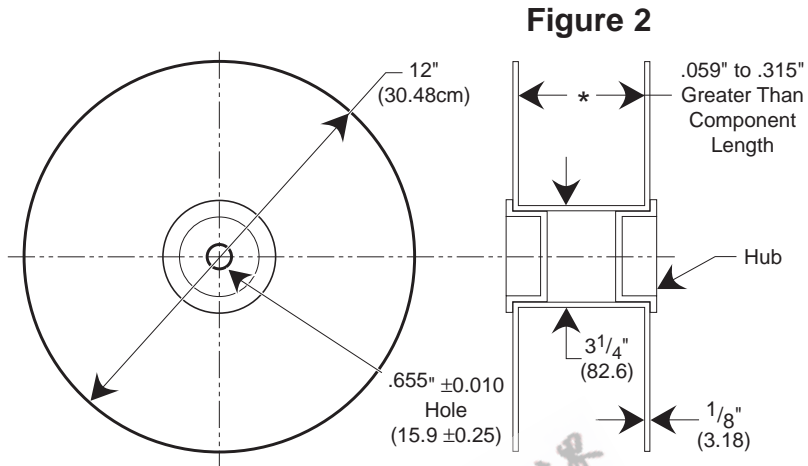
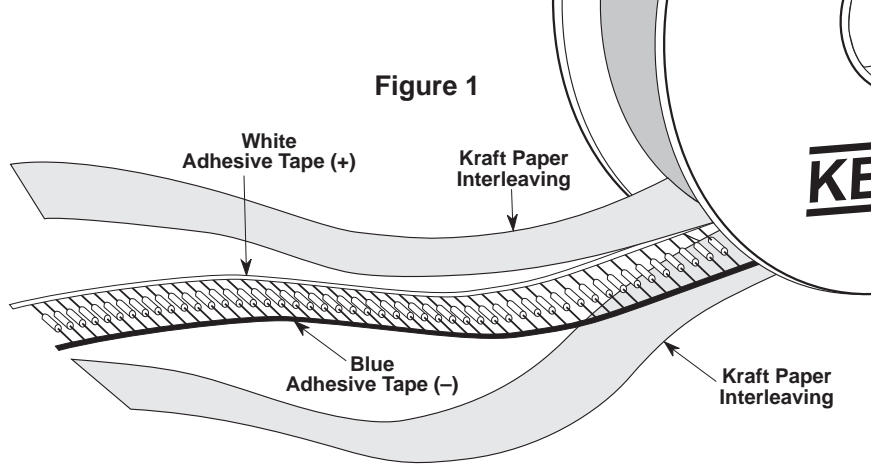

Table 1 Dimensions in Inches & (Millimeters)

COMPONENT BODY DIAMETER	COMPONENT PITCH "A"	INSIDE TAPE SPACE "B" ±1.5mm (0.0)	
		I	II
0" (0mm) to 0.197" (5mm)	0.200" or (5mm)	2.062"	2.500"
0.197" (5.01mm) to 0.394" (10mm)	0.400" or (10mm)	(52.4mm)	(63.5mm)

Capacitors are reeled so that positive leads are oriented as shown in Figure 3. Kraft paper is inserted between the layers of capacitors wound on reels for component pitch ≤ 0.200 " sizes. Kraft paper (70 lb. test minimum), single faced is inserted for component pitch ≥ 0.400 " sizes. Capacitors extend only a maximum of .031" (0.8 mm) beyond the tape's edges. Capacitors are centered on two tapes and will deviate only ± 0.031 " (0.79 mm) from the row center. Figures 1 and 2 show a chipboard tape reel. A minimum of 36" (91.5 cm) leader tape is provided at each end of the reel. Universal splicing clips are used to connect the tape. Standard reel quantities are shown on the drawing.

Component Base to Tape Center (4)	H	C-7301 16.0 (.630)	C-7303 18.0 (.709)	C-7301 ±0.5 (±.020)	C-7303 Minimum	Center		
Lead Standoff Height	H ₀	C-7301 16.0 (.630)	C-7303 18.0 (.709)	C-7301 ±0.5 (±.020)	C-7303 Minimum	Total Tape Thickness	T	10.2 (.400)
Component Height Above Tape Center	H ₁	32.25 (1.270)		Maximum		Carrier Tape Width	W	18.0 (.709)
Component Alignment Front to Rear	Δ H	0		1.0 (.039)		Hold-Down Tape Width	W ₀	15mm or 6mm (.561) (.236)
Cut Out Length	L	11.0 (.433)		Maximum		Sprocket Hole Location	W ₁	9.0 (.354)
Lead Protrusion	L ₁	1.0 (.039)		Maximum		Hold-Down Tape Location	W ₂	12mm (.472)

- Notes: (1) See page 62 for T35X and page 69 for T39X specific dimensions.
(2) Cumulative pitch error ± 1.0mm (.039) maximum in 20 consecutive sprocket hole locations.
(3) Measured at bottom of standoff.
(4) P₁ and F measured at egress from carrier tape.
(5) P and P₂ measured at egress from carrier tape.

On polar devices, the positive (+) lead exits from container first.
* Lead spacings are 2.5mm (.098") center-to-center (T350 A-H)
** Lead spacings are 5.0mm (.197") center-to-center

F Dimensions:

- 0.100" ± .015
- 0.125" ± .015
- 0.200" ± .015
- 0.250" ± .015"
- 0.100" ± .015 (3 leaded)

P1 Dimensions:

- Lead Spacing
- 0.100" - 0.200 ± .028"
- 0.125" - 0.187 ± .028"
- 0.200" - 0.150 ± .028"
- 0.250" - 0.125 ± .028"
- 0.100" - 0.100 ± .028" (3 leaded)

- ① T396/8*
- ② T350/1*
- ③ T352/3/4/5/6**

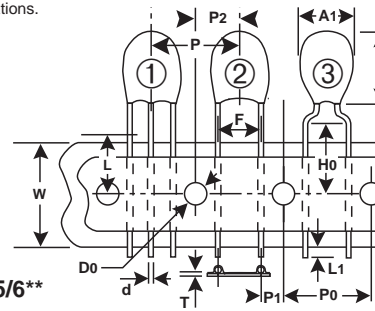

Tantalum Molded Radial – ARIS Specification (Automatic Radial Insertion)

Tantalum Molded Tape and Reel Dimensions in Millimeters & (Inches)

Dimension	Symbol	Nominal mm (inch)	Tolerance mm (inch)	Dimension	Symbol	Nominal mm (inch)	Tolerance mm (inch)
Body Height (1)	A	10.50 (.413)	± .38 (±.015) Maximum	Component Pitch (5)	P	12.7 (.500)	± 1.0 (± .039)
Body Width (1)	A ₁	15.24 (.600)	Maximum ± .38 ± (.015)	Sprocket Hole Pitch (3)	P ₀	12.7 (.500)	± 0.3 (±.012)
Sprocket Hole Diameter	D ₀	4.0 (.157)	± 0.3 (± .012)	Sprocket Hole Center to Lead Center (4) (5)	P ₁	3.85 4.76 5.1 (.152) (.188) (.201)	± 0.7 (±.028)
Lead Diameter	d	0.51 or 0.64 (.020) (.025)	± 0.05 or ± .03 (± .001)	Sprocket Hole Center to Component Center	P ₂	6.35 (.250)	± 1.3 (±.051)
Lead Center (5)	F	5.0 2.5 (.197) (.098)	+ 0.8/ - 0.2 (+ .032/ -.008)	Body Thickness	T ₀	6.35 (.250)	± 1.3 Maximum
Component Base to Tape Center (2)(4)(6)	H	18.0 (.709)	Reference Only	Total Tape Thickness	T	0.7 (0.28)	± .02 (±.008)
Lead Standoff Height	H ₀	N/A		Carrier Tape Width	W	18.0 (.709)	+ 1.0/-0.5 (+.039/- .020)
Component Height Above Tape Center	H ₁	32.25 (1.270)	Maximum	Hold-Down Tape Width	W ₀	15 or 6 (.561) (.236)	+ 1.0/-0.8 (+.039/.031)
Component Alignment Front to Rear	Δ H	0	± 2.0 (± .079)	Sprocket Hole Location	W ₁	9.0 (.354)	+ .075/-0.5 (+.030/- .020)
Cut Out Length	L	11.0 (.433)	Maximum	Hold-Down Tape Location	W ₂	3.0 or 12.0 (.118) (.472)	Maximum
Lead Protrusion	L ₁	2.0 (.079)	Maximum				

- Notes: (1) See page 50 for T330, page 53 for T340 and page 59 for T35X specific dimensions.
(2) Reference Only
(3) Cumulative pitch error ± 1.0mm (.039") maximum in 20 consecutive sprocket hole locations.
(4) Measured at bottom of standoff.
(5) P, P₁ and F measured at egress from carrier tape.
(6) H dimensions for T370 D and E 16.5mm ± 0.5mm (0.650" ± 0.020")

On polar devices, the positive (+) lead exits from container first.
* Lead spacings are 2.5mm (.098") center to center
** Lead spacings are 5.0mm (.197") center-to-center.

- ① T370
- ② T340**
- ③ T330**

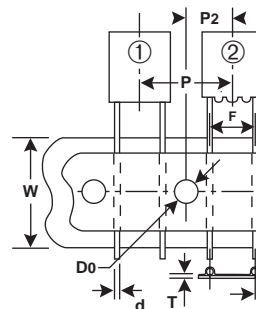

T111/T213	CSR91	MIL-C-39003/4	A	60/Box	3000	12"
			B	30/Box	2000	12"
			C	10/Card	N/A	N/A
			D	10/Card	N/A	N/A
T210, T216, T240, T256	CSS13	MIL-C-39003/10	A	40/Tray	3500	12"
			B	30/Tray	2500	12"
			C	20/Tray	500	12"
	CSS33	MIL-C-39003/10	D	20/Tray	400	12"
T222	CSR09	MIL-C-39003/2	A/B	50/Tray	N/A	N/A
			A	300/Box	N/A	N/A
			B	150/Box		
T322/T323	CX01, CX05	MIL-C-49137/1 & 5	A	300	4500	12"
			B	250	4000	12"
			C	100	2500	12"
			D	100	2500	12"
			E	100	500	12"
			F	100	500	12"
T330			A	400	1000	12"
			B	300	1000	12"
			C	200	1000	12"
			D	100	N/A	N/A
T340			A	300	1000	12"
			B	300	1000	12"
			C	200	1000	12"
			D	100	250	12"
			E	50	150	12"
			F	100	N/A	N/A
T350, T351, T352, T353, T354, T355, T356			A	1000	1500	12"
			B	1000	1500	12"
			C	1000	1500	12"
			D	1000	1000	12"
			E	1000	1000	12"
			F	500	1000	12"
			G	500	1000	12"
			H	500	800	12"
			J	100	800	12"
			K	100	500	12"
			L, M	100	500	12"

NOTE: (1) Each KEMET number in its section applies to all case sizes.

(2) Standard packaging refers to number of pieces per lot.

KEMET Electronics Corporation, P.O. Box 5928, Greenville, S.C. 29606 (864) 963-6300

			D	500	500
T369	CX12	MIL-C-49137/2	A	1000	1500
			B	1000	1500
T370			C	500	N/A
			D	500	1000
			E	500	1000
			F	250	N/A
T378	CX06	MIL-C-49137/6	D	200	1000
			E	180	1000
			F	50	N/A
T396, T398			A-B	1000	1500
			C	500	1500
			D-F	500	1000
			G	500	1000
			H	500	800
			J	250	800
			K	250	500
			L-M	250	500

NOTE: (1) Standard packaging refers to number of pieces per bag, box, tray or vial.

(2) Quantity varies. For further details, please consult the

EEPW 电子產品世界
[.com.cn](http://www.eepw.com.cn)

leakage, capacitance and dissipation factor. All Series are inspected to electrical limits using a minimum .1% AQL sampling plans, according to the Military Standard MIL-STD-105, even after 100% testing. This sampling plan, to the best of KEMET Electronics' knowledge, meets or exceeds the generally accepted industry standard for similar products. KEMET capacitors may also be supplied, with prior agreement, to meet specifications with requirements differing from those of KEMET catalogs. **Reference ESR values are provided but are NOT 100% screened**

These Notes apply generally to all KEMET solid tantalum capacitors and illustrate typical performance under normal application conditions, except where noted. Certain Series will respond differently to various environmental conditions. For example, hermetically sealed series are relatively immune to humidity effects, while plastic-encased series are not. The intent of these Notes is not to delineate such differences but to provide generalized information concerning performance characteristics.

1. GENERAL APPLICATION CLASS

Solid tantalum capacitors are usually applied in circuits where the AC component is small compared to the DC component. Typical uses known to KEMET Electronics include blocking, by-passing, decoupling, and filtering. They are also used in timing circuits. If two of these polar capacitors are connected "back-to-back" (i.e., negative-to-negative or positive-to-positive), the pair may be used in AC applications (as a non-polar device).

2. STORAGE CONDITIONS

Capacitors may be stored without applied voltage over the operating temperature range specified in the catalogs for each Series. The range is from -55 to +125° C for all Series.

Tantalum capacitors do not lose capacitance from the "de-forming" effect as do liquid-electrolytic capacitors. Storage at high temperature may cause a small, temporary increase in leakage current (measured under standard conditions), but the original value is usually restored within a few minutes after application of rated voltage.

Series which are not hermetically sealed exhibit reversible changes in parameters with respect to relative humidity (RH). Capacitance increases with increasing humidity. The limiting change, reached upon establishment of equilibrium with the environment, is approximately -5% to +12% over the range from 25% to 95% RH, referred to the standard 50% RH. The amount of change is dependent upon size (capacitance and voltage rating, i.e. CV product); small sizes might change no more than ±5%. Equilibrium at such extremes is seldom attained by plastic-cased capacitors, and the change in capacitance is consequently less. The rate of response to humidity changes increases with increasing temperature.

the air, increasing the effect. The term is leakage current.

3. POLARITY

These capacitors are inherently polarized. They may be permanently damaged or shorted if connected with the wrong polarity. The position of the polarity marking on the capacitor body by a polarity marking on the capacitor body may include an obvious marking. However, some Series contain two polarities (negative-to-negative) to form a non-polar capacitor. Rated voltage (see para. 8) may be applied in either Series in either direction.

4. OPERATING ENVIRONMENT

Most of the discussion under "Storage Conditions" will apply also when capacitors are in operation. Applicable electrical ratings describe the maximum primary increase in leakage current (measured under the following elevated-temperature exposure conditions) however, if the capacitors are operated at the rated voltage applied.

5. CAPACITANCE

Capacitance is measured at 120 Hz with up to 1 volt rms applied. Note that the peak AC plus DC bias must not exceed the rated voltage (normally polarized) or 15% of the rated voltage in reverse direction at 25°C. Measurements are made at high impedance, however, and up to 1 volt rms may be applied even to capacitors with peak reversal) without a DC bias. Capacitors are normally not used, except when rated voltage is applied, if the AC signal level exceeds the rated voltage. MIL-C-39003 provides for up to 2.5% change.

DC bias causes a small reduction in capacitance to about 2% when full rated voltage is applied. It is also reduced by the presence of AC. The effect of AC cause a decrease in DF of about 0.2% from 3.6 to 3.4% DF).

Capacitance changes very little with frequency. It decreases more noticeably at high frequencies. Capacitance values decline more noticeably at high frequencies. The effect of frequency upon capacitance is shown in Figure 1.

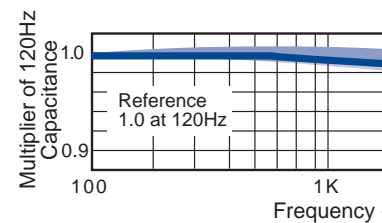

Figure 1. Normal Effect of Frequency on Capacitance

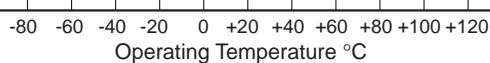

Figure 2. Typical Effect of Temperature upon Capacitance

6. DISSIPATION FACTOR (DF)

DF is measured at 120 Hz and 25° C with up to 1 volt rms applied. Note that, in either operation, peak AC plus DC bias must not exceed either rated voltage (normally polarized) or 15% of rated voltage in the reverse direction at 25°C. Measurement circuits are of high impedance, however, and under these conditions 1 volt rms may be applied even to 6 volt capacitors (23% peak reversal) without a DC bias. DC bias is thus normally not used, except when rated voltage is below 6 volts and the AC signal level exceeds 0.3 vrms. However, MIL-C-39003 provides for up to 2.2 volts DC.

Dissipation Factor (DF) is a useful low-frequency measure of the resistive component in capacitors. It is the ratio of the unavoidable resistance to the capacitive reactance, usually expressed in percent. DF increases with temperature above +25° C and may also increase at lower temperatures. Unfortunately, one general limit for DF cannot be specified for all capacitance/voltage combinations, nor can response to temperature be simply stated. Catalogs for the respective series list DF limits under various conditions.

Dissipation factor increases with increasing frequency as would be expected from the decreasing capacitive reactance. DF is not a very useful parameter above about 1 kHz. The DF of larger capacitance values increases more rapidly than that of smaller ratings. Figure 3 shows typical effect of frequency on DF.

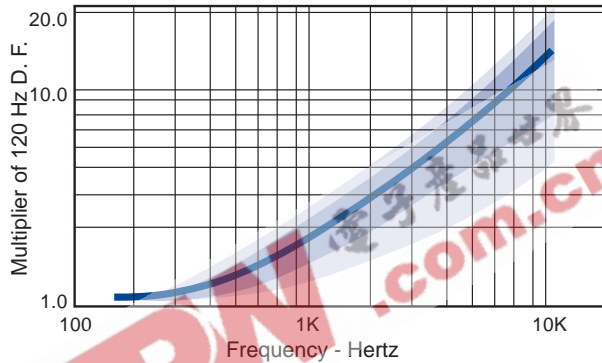

Figure 3. Normal Effect of Frequency upon Dissipation Factor

DC bias causes a small reduction in capacitance, up to about 2% when full rated voltage is applied, as bias. DF is also reduced by the presence of DC bias. Rated voltage may cause a decrease in DF of about 0.2% (e.g., a decrease from 3.6 to 3.4% DF).

DF is defined as $\frac{ESR}{\chi_c}$ and is also referred to occasionally, as tan d or "loss tangent." The "Quality Factor," Q, is the reciprocal of DF (DF is not expressed in

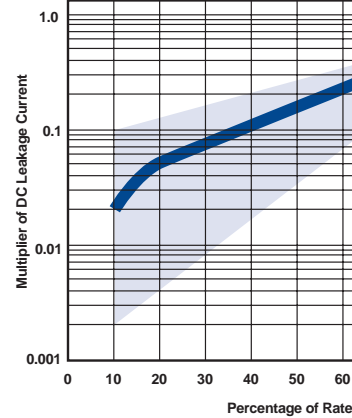

Figure 4. Typical Range of DC Leakage Current as a Function of Applied Voltage

DC leakage current (DCL) increases with increasing temperature according to the typical

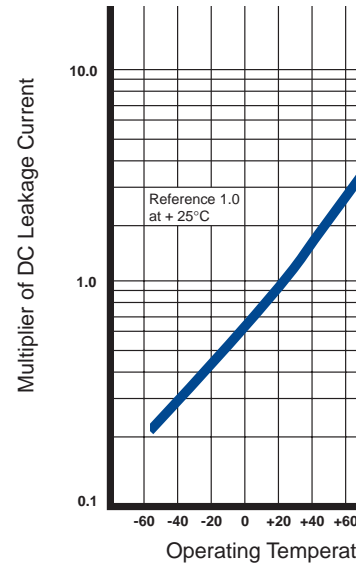

Figure 5. Typical Effect of Temperature upon DC Leakage Current

Leakage current is measured at +25°C and may also be measured at +85°C and may also be measured at 2/3 of rated voltage applied.

8. RATED VOLTAGE

This term refers to the maximum working voltage permissible at temperature below. The lower operating temperature is -55° C. Operation above +85° C requires reduced working voltage. Typical maximum operating voltage is 2/3 of rated voltage at +125° C.

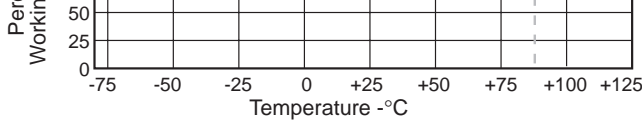

Figure 6. Working Voltage Change with Temperature

10. SURGE VOLTAGE

Surge voltage is defined as the maximum voltage to which the capacitor should be subjected under transient conditions, including peak AC ripple and all DC transients.

DC Working Voltage @ 85°C	2	3	4	6	10	15/16	20	25	35	50	60	75	100	125
Surge Voltage @ 85°C	2.6	4	5.3	8	13	20	26	33	46	65	78	98	130	140

TABLE 1 Surge Voltage Ratings

A typical surge voltage test is performed at +85°C with the applicable surge voltage per Table 1. The surge voltage is applied for 1000 cycles of 30 seconds on voltage through a 33 ohm series resistor and 30 seconds off voltage with the capacitor discharged through a 33 ohm resistor. Upon completing the test, the capacitors are allowed to stabilize at room temperature. Capacitance, DF, and DCL are then tested:

1. The DCL should not exceed the initial 25°C limit.
2. The capacitance should be within ±10% of initial value.
3. The DF should not exceed the initial 25°C limit.

11. REVERSE VOLTAGE

Although these are polar capacitors, some degree of transient voltage reversal is permissible, as seen below. The capacitors should not be operated continuously in reverse mode, even within these limits.

Temperature, °C.	Percentage of Rated Voltage
+25	15
+85	5
+125	1

TABLE 2 Reverse Voltage Ratings

12. EQUIVALENT SERIES RESISTANCE (ESR)

Equivalent Series Resistance (ESR) is the preferred high-frequency statement of the resistance unavoidably appearing in these capacitors. ESR is not a pure resistance, and it decreases with increasing frequency. Typical ESR limits are established in each specific product series. However, the ESR limits provided are for reference only, and are not necessarily the actual value that a particular Series product will attain.

$$X_C = \frac{1}{2\pi f C}$$

where:
 f = frequency, Hertz
 C = capacity, Farad

Figure 7a Total Impedance Below Resonance

$$X_L = 2\pi f L$$

where:
 f = frequency, Hertz
 L = inductance, Henries

Figure 7b Total Impedance Above Resonance

To understand the many elements of a capacitor, see Figure 8.

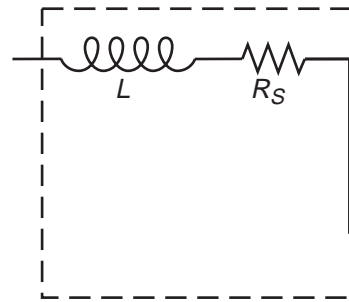

Figure 8. The Real Capacitor

A capacitor is a complex impedance consisting of many series and parallel elements. The complexity of the measurement system is a function of the frequency of the measurement.

L — Represents lead wire inductance. In most instances (especially at high frequencies), the inductance of the lead wires is significant.

significant in high frequency measurements and applications. Its value varies with frequency.

Cd — The inherent dielectric absorption of the solid tantalum capacitor which typically equates to 1-2% of the applied voltage.

As frequency increases, X_C continues to decrease according to its equation above. There is unavoidable inductance as well as resistance in all capacitors, and at some point in frequency, the reactance ceases to be capacitive and becomes inductive. This frequency is called the self-resonant point. In solid tantalum capacitors, the resonance is damped by the ESR, and a smooth, rather than abrupt, transition from capacitive to inductive reactance ($X_L = 2\pi fL$) follows.

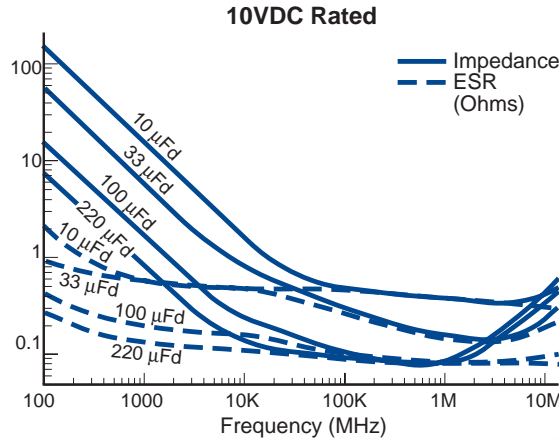

Figure 9. ESR and Impedance vs. Frequency

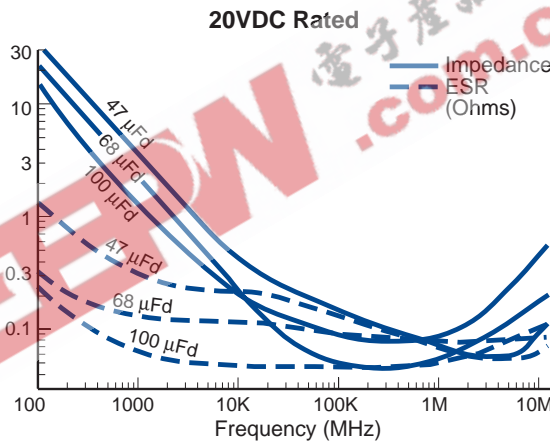

Figure 10. ESR and Impedance vs. Frequency

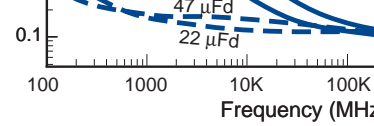

Figure 11a. ESR and Impedance vs. Frequency

Typical ESR and Z performance for representative capacitor ratings in Figure 11. Measured impedance will be affected by the lead wire included. Data for the curves is for 1/2" of each lead wire in the measurement.

Despite the fact that the reactance becomes inductive above the self-resonance, there are decoupling devices above 100 MHz that have been developed for minimum impedance. They are used above 100 MHz.

ESR and Z are also affected by temperature. At 100 kHz, ESR decreases with increasing temperature. The amount of change is influenced by the capacitor and is generally more pronounced for larger values.

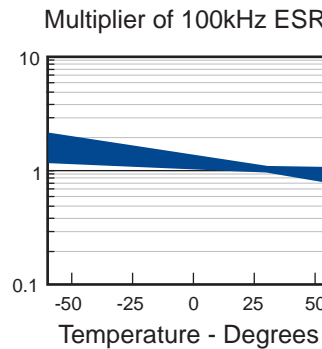

Figure 11b Typical Effect of Temperature on 100 kHz ESR

13. POWER DISSIPATION

Permissible power dissipation is established for all Series and is listed in the respective product section.

See pages 6-41 for hermetic sealed, 42-45 for radial molded, and 61-70 for tantalum capacitors.

It is usually most convenient to calculate permissible power into an AC voltage ripple. For a sinusoidal waveform, the "ripple voltage" is calculated from the impedance and the ripple current. See the respective product section. However, the following may be observed:

where: I = rms ripple current (amperes)
 E = rms ripple voltage (volts)
 P = power (watts)
 Z = impedance at specified frequency (ohms)
 R = equivalent series resistance at specified frequency (ohms)

Maximum allowable rms ripple voltage may be determined as follows:

$$E(\text{max}) @ 25^{\circ}\text{C} = Z \frac{P(\text{max})}{R}$$

$$E(\text{max}) @ 85^{\circ}\text{C} = 0.9 E(\text{max}) @ 25^{\circ}\text{C}$$

$$E(\text{max}) @ 125^{\circ}\text{C} = 0.4 E(\text{max}) @ 25^{\circ}\text{C}$$

$$P(\text{max}) = \text{maximum watts shown on Performance Characteristic pages 5, 42, 49, 58 and 61.}$$

Permissible AC ripple current can be determined by the following:

$$I_{\text{rms}} = \sqrt{\frac{P(\text{max})}{R}}$$

If two polar capacitors are connected back-to-back, (1) the pair may be operated on AC without need for DC bias. The first two criteria above must be observed. If DC is applied, the sum of DC and peak AC must not exceed, in either direction, the maximum working voltage specified for the ambient temperature.

(1) Some KEMET Series provide convenient assemblies of non-polar pairs. The two negative terminals are connected internally. It is also permissible to connect the two positive terminals to form a non-polar pair.

14. LONG-TERM STABILITY

Within the general class of electrolytic capacitors, solid tantalum capacitors offer unusual stability of the three important parameters: capacitance, dissipation factor, and leakage current. These solid-state devices are not subject to the effects of electrolysis, deforming or drying-out associated with liquid-electrolyte capacitors.

When stabilized for measurement at standard conditions, capacitance will typically change less than $\pm 3\%$ during a 10,000 hour life test at $+85^{\circ}\text{C}$. The same comparative change has been observed in shelf tests at $+25^{\circ}\text{C}$ extending for 50,000 hours. (Some of this change may stem from instrument or fixture error.)

Dissipation factor exhibits no typical trend. Data from 10,000 hour life tests at $+85^{\circ}\text{C}$ show that initial limits (at standard conditions) are not exceeded at the conclusion of these tests.

Leakage current is more variable than capacitance or DF; in fact, leakage current typically exhibits a logarithmic dependence in several respects. MIL-C-39003/1 permits leakage current (measured at standard conditions) to rise

temperature. As with any practical capacitor, also possess an inherent, although when operated within the rated conditions.

The dominant failure mode is parametric drifts (see Section 14 "Leakage" of no consequence in circuits suitably designed with capacitors. Catastrophic failure occurs when DC leakage current over a short period of time causes the capacitor to fail. The failed capacitor, while called "leaky", exhibit a DC resistance of 10 to 100 ohms.

If a failed capacitor is in an impedance circuit, continued flow of current through the capacitor may obviously produce severe heating which may melt the internal solder (all solders used in hermetic Series). This may thereby be converted to an open circuit. If the circuit does not open promptly, the capacitor may damage the circuit board components. Protection against such occurrences is provided by limiting devices or fuses provided in the circuit.

Fortunately, the inherent failure rate of tantalum capacitors is low, and this may be further improved by circuit design. Standard test procedures are provided for those capacitors with "A" in the next-to-last position of the part number. The circuit conditions to failure rate is discussed in the section following.

16. RELIABILITY PREDICTION

Three important application conditions are: failure rate: DC voltage, temperature, and ambient humidity. Estimates of the respective failure rates are shown on the nomograph in Figure 12 and on the nomograph related failure rate to voltage. While the table relates failure rate to voltage, the estimates apply to steady-state DC voltage usage within all other rated conditions.

Standard conditions, which include a failure rate factor, are rated voltage, $+85^{\circ}\text{C}$, and circuit impedance. While voltage and temperature are straightforward there is sometimes confusion about impedance. What is required is the total impedance by the capacitor. If several capacitors are connected in parallel, the impedance seen by the source of energy stored in the other capacitors is similarly stored in series inductors.

Failure rate is conventionally expressed in percent per thousand hours. As a sample, suppose a particular batch of capacitors has a failure rate of 0.5% Khr under standard conditions. What is the predicted failure rate at 0.7 times rated voltage and $0.8\Omega/\text{V}$? The nomograph gives a factor of 0.3. The failure rate is

$$0.5 \times 7 \times 10^{-4} \times 0.3 = 1.05 \times 10^{-4} \text{ Khr}$$

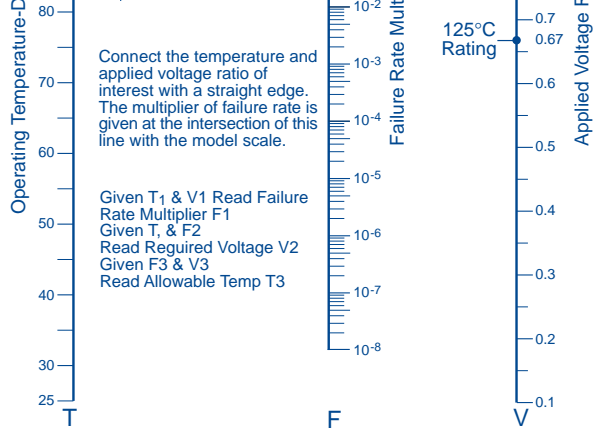

Figure 12. Reliability Nomograph

Circuit Impedance (ohms/volt)	Failure Rate Improvement (multiplying factors)
0.1	1.0
0.2	.8
0.4	.6
0.6	.4
0.8	.3
1.0	.2
2.0	.1
3 or greater	.07

TABLE 3 Relationship of Failure Rate to Impedance

Voltage “de-rating” is a common and useful approach to improved reliability. It can be pursued too far, however, when it leads to installation of higher voltage capacitors of much larger size. Inherent failure rate is roughly proportional to $CV^{1.6}$, where C is capacitance and V is rated voltage. The effect becomes particularly noticeable above 50-volt ratings. It is possible to lose more via higher inherent failure rate than is gained by voltage derating.

The relationships shown are more useful when the failure rate has been statistically determined for a given group of capacitors.

Failure rate is statistically determined for each production batch of KEMET High Reliability capacitors, as described in Specification GR500 Catalog F2956. As noted above, not all capacitance/voltage rate values are inherently equal in failure rate. GR500 capacitors are processed and subjected to 100% reliability testing as a homogeneous group of one capacitance/voltage value. Failure rate under standard conditions is available from 1 to 0.001% Khr, depending upon the capacitance/voltage value.

Several Series are qualified under U.S. military specification MIL-C-39003. Failure rates as low as 0.001%/Khr are available for all capacitance/voltage values in given groups under this test program. The specifications and

series resistance.

17. SURGE CURRENT

All conventional reliability tests are performed at steady-state DC voltage. Experience has shown that, within the limits prescribed, heavy surge currents are possible, however. Circuit impedance and surge current are the standard 0.1 ohm/volt) or there may be a tolerance to cause voltage “ringing” or “overshoot” to appear during turn-on of equipment.

Failure rate under current-surge conditions may not be predictable from conventional life tests. A current test is utilized to ensure against such failures, and a description is available in MIL-C-39003/06/09/10 and KEMET High Reliability Capacitors.

18. ENVIRONMENTAL CONSIDERATIONS

It is not possible to foresee all environmental conditions which every Series will be subjected to. Standard tests which every Series will be subjected to are available (upon request) under military specifications for certain Series.

- LIFE TEST 85°C OR 125°C, 2000 hours. Capacitors subjected to 2000 hours at 85°C at 2/3 of rated voltage, or 125°C at 2/3 of 85°C voltage, then subjected to the following requirements when returned to rated voltage:

The DCL shall be within 1.2 times the rated value.

Capacitance shall be within 10% of the rated value.

The DF shall not exceed the rated value.

- SHELF LIFE +85°, 2000 hours. Capacitors shall meet the following requirements when returned to 25°C:

The DCL shall be within 1.2 times the rated value.

Capacitance shall be within 10% of the rated value.

The DF shall not exceed 1.5 times the rated value.

- LEAD STRENGTH MIL-STD-202. Lead strength testing will be performed as in MIL-STD-202, with the following details and exceptions:
 - a. Test condition letter—A
 - b. The body of the capacitor will not be tested during test.

- ified DC rated voltage shall be applied to the capacitors.
- c. Test condition letter—D (20 G).
 - d. Duration and direction of motion—4 hours in each of two mutually perpendicular directions (total of 8 hours), one parallel and the other perpendicular to the axis.
 - e. Measurements during vibration—During the last cycle, an electrical measurement shall be made to determine intermittent operation or open- or short-circuiting. Observations shall also be made to determine intermittent contact or arcing or open- or short-circuiting. Detecting equipment shall be sufficiently sensitive to detect any interruption with a duration of 0.5 ms, or greater.
 - f. Examination after test—Capacitors shall be visually examined for evidence of mechanical damage.
- **SHOCK TEST:** Per MIL-STD-202, Method 213. The following details shall apply:
 - a. Special mounting means—Capacitors shall be rigidly mounted on a mounting fixture by the body. When securing leads, care shall be taken to avoid pinching the heads.
 - b. Test-condition letter—I (100 G peak). 6 ms. (sawtooth)
 - c. Measurements and electrical loading during shock—During the test, observations shall be made to determine intermittent contact or arcing or open- or short-circuiting. Detecting equipment shall be sufficiently sensitive to detect any interruption with a duration of 0.5 ms. The DC rated voltage shall be applied to the capacitors during the test.
 - d. Examinations after test—Capacitors shall be visually examined for evidence of arcing, breakdown, and mechanical damage.
 - **HUMIDITY LIFE TEST:** Capacitors shall be capable of withstanding 1000 hours at 55°C with an ambient humidity of 90-95% RH with rated DC voltage applied. After the capacitors have stabilized for a period of 24 hours at 25°C, they shall meet the following limits:
 - DCL shall not exceed 5 times the initial limit.
 - Capacitance shall be within $\pm 10\%$ of the initial value.
 - DF shall not exceed 2 times the initial limit.
 - **THERMAL SHOCK—MIL-STD-202, Method 107:** Capacitors shall be subjected to thermal shock in accordance with MIL-STD-202, Method 107, Test Condition A. M39003 Components tested to MIL-STD-202, Method 107, Condition B. Measurements before and after

- MIL-STD-202, Method 107 details:
- a. Mounting—The capacitors shall be mounted by normal mounting means
 - b. Initial Measurements
 - c. Polarizing and Load Voltage—
 - d. Final measurements—After 2 to 6 hours after removal of the humidity chamber, capacitance and DC leakage will be measured.

DCL should not exceed the initial value.
Capacitance should be within $\pm 10\%$ of the measured value.
DF should not exceed the initial value.

- **RESISTANCE TO SOLVENTS—MIL-STD-202, Method 215:**
 - Brushing required after test.
 - DCL meets limit shown in respective Tables.
 - Capacitance meets applicable to respective Tables.
 - DF meets limits shown in respective Tables.
 - No visible damage to case or metal parts.
- **RESISTANCE TO SOLDERING HEAT—MIL-STD-202, Method 210, Test Condition Letter B. (260° for 10 Sec.)**
 - Leads shall be immersed to within 10 mm of the capacitor body. Capacitance, DF, and DCL shall meet the nominal limits shown in respective Tables.
- **SOLDERABILITY — MIL-STD-202, Method 208**
 - Number of terminations on each lead shall be 1.
 - Depth of insertion in flux and solder shall be 1.5 times the capacitor body.
- **FLAMMABILITY — The encapsulated capacitor shall meet the following requirements:**
 - Underwriters Lab. UL 94V-0
 - Oxygen Index per ASTM-D-2869 shall be 28% min.
- **STABILITY AT LOW AND HIGH TEMPERATURES—MIL-STD-202, Method 103**
 - 55°C to 125°C: Capacitors shall be subjected to a succession of continuous steps at -55°C, +85°C, +125°C, +25°C, in the order specified. Measurements shall be brought to thermal

- value; ESR, DF within limit shown in Part Number Tables.
- Step 3, +25°C, DCL as indicated in original limit; capacitance within $\pm 5\%$ of initial value; ESR, DF within limit shown in Part Number Tables.
- Step 4, +85°C, DCL shall not exceed 10 times original DCL limit at 25°C. Capacitance shall be within $\pm 10\%$ of the initial value. DF shall be within 125% of limits shown in Part Number Tables. ESR shall be within limits shown in Part Number Tables.
- Step 5, +125°C, DCL shall not exceed 12.5 times the original limit at 25°C. Capacitance shall be within $\pm 12\%$ of initial value. DF shall be within 150% of limits shown in Part Number Tables. ESR shall be within limits shown in Part Number Tables.
- Step 6, +25°C, DCL as indicated in original limit; capacitance within $\pm 5\%$ of initial value; ESR, DF as indicated in original limit shown in Part Number Tables.

Note: M39003 specifies Δ 's and limits by individual slash sheet.

- DAMP HEAT, STEADY STATE: Meets requirements of IEC Publication 384-15, method IEC 68-2-3. Climatic category 55/125/56.

19. MOUNTING

All encapsulated Series fall into two general classes. The first is provided with leads extending from opposite ends of the body, generally along the principle axis of the body ("axial leads"). The second is provided with parallel leads extending from one side or face of the body ("radial leads"). With either type, mounting points are normally provided by the leads themselves.

Axial leads may be used for point-to-point wiring, but usually, the wires are bent at 90° from the capacitor axis for insertion through printed circuit (PC) boards. Axial capacitors supplied on reels for machine insertion will withstand the mechanical stresses of bending and insert-

ode connection on most Series is and a silver-pigmented paint. If too this solder may remelt and degrade face or cause a direct short-circuit

KEMET's hermetically-sealed space into which molten cathode ing the cathode connection and p the terminals to short-circuit the ca It is also possible to remelt the sold of the glass-metal seal, causing possibly a short-circuit. Finally, so the positive wire may be remelted solder is a high-temperature alloy, less likely to be melted. (Re-dippin ticed by some users, introducing an ing this solder).

Plastic-encased Series have the internal cathode connection. T through the plastic is lower than th hermetic Series, but conduction a wire to remelt this solder is very sin al void within plastic cases, so re remain in its original location and removed. Short-circuiting is very u the internal connection may be co of silver from the paint into the m effect degrades the cathode conn as well.

All encased capacitors will p Soldering Heat Test of MIL-S Condition B. This test dips each le der at +260° C for 10 seconds whi held vertically above the solder. pass this test when the depth o capacitor body (or closest external er as in some hermetic Series) to 0.100 inches from the solder surfac of resistance to solder heat is in a believed to be the industry stand ment must be considered reflectiv ing process.

Shown in Figure 13 is a rec profile for both axial and radial capacitors.

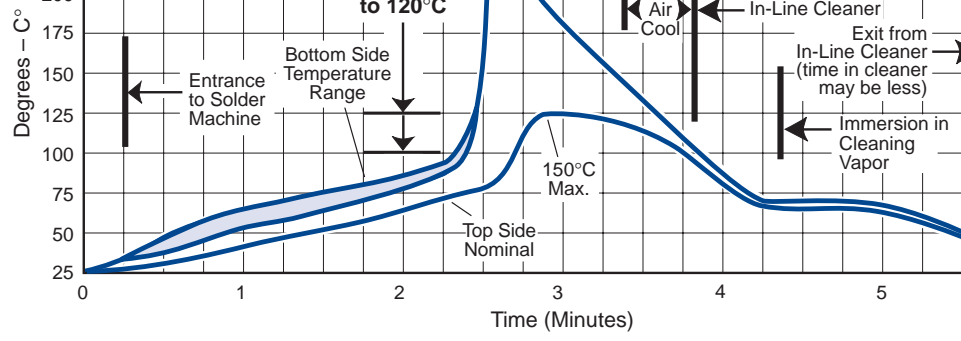

Figure 13.

EEPW 电子产品世界
 .com.cn

KEMET® *Electronics Corporation*

World Sales Headquarters
P.O. Box 5928 • Greenville, SC 29606 • www.kemet.com
Phone: (864) 963-6300 • Fax: (864) 963-6521

USA/Canada Locations

KEMET Electronics Corporation
26 Corporate Plaza, Suite 170
Newport Beach, CA 92660
Phone: 949-640-9320
Fax: 949-720-9807

KEMET Electronics Corporation
2359 Mission College Blvd., Suite 390
Santa Clara, CA 95054
Phone: 408-986-0424
Fax: 408-986-1442

KEMET Electronics Corporation
Schaumburg Corporate Center
Suite 350, 1515 Woodfield Road
Schaumburg, IL 60173
Phone: 847-517-1030
Fax: 847-517-1030

KEMET Electronics Corporation
301 Edgewater Place, Suite 208
Wakefield, MA 01880
Phone: 781-245-4646
Fax: 781-245-1595

KEMET Electronics Corporation
Piedmont Center East, Suite 410
B-137, 37 Villa Road
Greenville, SC 29615
Phone: 864-242-5789
Fax: 864-242-5795

KEMET Electronics Corporation
8445 Freeport Parkway, Suite 320
Irving, TX 75063
Phone: 972-870-9530
Fax: 972-870-9537

KEMET Electronics Canada Ltd.
105-7145 West Credit Ave., Bldg. #2
Mississauga, L5N 6J7, ON
Canada
Phone: 905-542-7930
Fax: 905-542-7949

KEMET Electronics Canada Ltd.
65 boul. Brunswick, Suite 214
Dollard-des-Ormeaux, QC
Canada
Phone: 514-685-3773
Fax: 514-685-4077

Europe/Africa Locations

KEMET Electronics S.A.R.L.
2, Rue Nicolas Ledoux
Silic 254
94568 Rungix Cedex
France
Phone: 33-1-4512-5320
Fax: 33-1-4687-4087

KEMET Electronics GmbH
Postfach 1380
D85531 Haar/Munich
Germany
Phone: 49-89-456-4200
Fax: 49-89-460-4117

KEMET Electronics S.A.
1-3, Avenue de la Paix
P.O.B. 76
CH-1211 Geneva 20,
Switzerland
Phone: 41-22-715-0100
Fax: 41-22-715-0170

KEMET Electronics Ltd.
Waterfront House, 55/61 South St.
Bishop's Stortford
Hertfordshire, CM23 3AL
United Kingdom
Phone: 44-1279-75-7343
Fax: 44-1279-75-7188

Aviv Electronics Ltd.
Hayetzira St. No. 4
P.O. Box 2433
Ra'anana, 43100
Israel
Phone: 972-9-748-3232
Fax: 972-9-741-6510

Multitech Electronics Corporation PTY
P.O. Box 23351
Claremont 7735, South Africa
Phone: 27-21-64-4103
Fax: 27-21-64-1360

Arrow Altech Distribution PTY LTD
53 - 57 Yaldwyn Road
Hughes Ext.
Jet Park 1459
South Africa
Phone: 27-11-923-9600
Fax: 27-11-923-9884

Asia Locations

KEMET Electronics (Shanghai) Co., Ltd.
2/F, No. 7 Bldg., 330 Xlya Rd.
Waigaoqiao Free Trade Zone
Pudong, Shanghai 200137, China
Phone: 86-21-5046-0983
Fax: 86-21-5046-0981

KEMET Electronics Asia Ltd.
(Beijing Representative Office)
Suite 1512, 15/F, Lucky Tower B
3 Dong San Huan Bei Rd., Chao Yang District
Beijing, 100027, China
Phone: 86-10-6462-0173
Fax: 86-10-6461-5707

KEMET Electronics Asia Ltd.
4A Chuan Hing Industrial Bldg.
14 Wang Tai Road
Kowloon Bay, Hong Kong
Phone: 852-2305-1168
Fax: 852-2759-0345

KEMET Electronics Marketing PTE Ltd.
8-2-04, Sunny Point Kompleks, Jalan
Batu Uban, 11700 Penang
Penang, Malaysia
Phone: 60-4-6595200
Fax: 60-4-6595220

KEMET Electronics Marketing PTE Ltd.
101 Thomson Road, #23-03
United Square
Singapore, 307591, Singapore
Phone: 65-353-6636
Fax: 65-353-6656

KEMET Electronics Corporation
Taiwan Branch, 3-4F, No. 148, Section 4
Chung-Hsaio E. Rd.
Taipei, Taiwan ROC
Phone: 886-2-27528585
Fax: 886-2-27213129

Bestrade Limited
28/3 Charoren Vian Road Silcom
Bangrak, Bangkok 10500, Thailand
Phone: 662-235-1613
Fax: 662-237-7132

Crusader Electronics Pty. Ltd.
Unit 3, 92 Bryant Street
Padstow, NSW 2211, Australia
Phone: 612-9792-3922
Fax: 612-9792-1446

Electronic Enterprises Private Ltd.
Post Bag No. 6367
Unit 216 Regal Industrial Estate
Acharya Donde Marg., Sewri
Bombay 400 015, India
Phone: 91-22-413-7096
Fax: 91-22-413-3341

Unicom International Corporation
702 Shinhwa Bldg., Mapo-Gu
Seoul, 121050, Korea

NOTICE: Place 011 in front of the above Phone and Fax numbers for Europe and Asia, when dialing from a United States exchange.
Note: KEMET reserves the right to modify minor details of internal and external construction at any time in the interest of product improvement.
KEMET does not assume any responsibility for infringement that might result from the use of KEMET Capacitors in potential circuit designs.
"KEMET" is a registered trademark of KEMET Electronics Corporation.