



Models Available

Features/Benefits

- Compact size—small footprint
- Single and double pole models
- PC and panel mount options available

Typical Applications

- Hand-held telecommunications
- Instrumentation
- Medical equipment

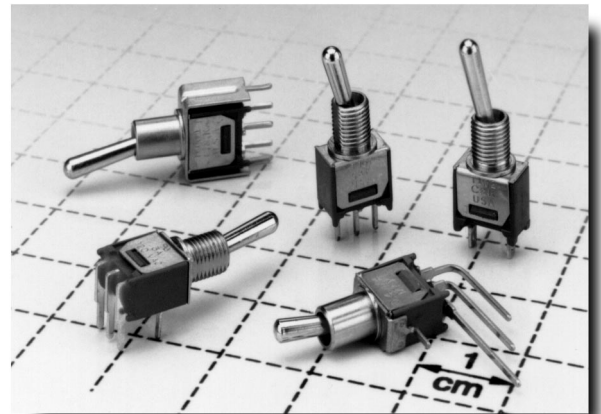

Build-A-Switch

Our easy Build-A-Switch concept allows you to mix and match options to create the switch you need. Below is a complete listing of options shown in catalog. To order, simply select desired option from each category and place in the appropriate box. Switches with standard options are shown on pages A-40 and A-41. Available options are shown and described on pages A-41 thru A-45. For additional options not shown in catalog, consult Customer Service Center. All models have epoxy terminal seal and are compatible with all "bottom-wash" PCB cleaning methods.

Typical Example:



Switch Function

- T101 (STD.) SPDT On-None-On
- T103 (STD.) SPDT On-Off-On
- T105 (STD.) SPDT Mom.-Off-Mom.
- T201 (STD.) DPDT On-None-On
- T102 SPST Off-None-On
- T107 SPDT On-Off-Mom.
- T108 SPDT On-None-Mom.
- T203 DPDT On-Off-On
- T205 DPDT Mom.-Off-Mom.
- T207 DPDT On-Off-Mom.
- T208 DPDT On-None-Mom.
- T211 DPDT On-On-On

Actuator

- M (STD.) .210" high
- P3 (STD.) Flatted, anti-rotation, .450" high
- S (STD.) .370" high
- K Locking lever
- K1 Locking lever
- L .290" high
- L1 .620" high
- M1 .220" high
- S1 .410" high

Bushing

- H (STD.) .220" high, threaded, flat
- H9 (STD.) .220" high, unthreaded, flat
- CF Splashproof, .310" high, threaded, flat
- D9 .260" high, unthreaded, keyway
- K9 .310" high, unthreaded, keyway
- T .310" high, threaded, flat
- T9 .310" high, unthreaded, flat
- TD .260" high, threaded, keyway
- TK .310" high, threaded, keyway
- Y .220" high, threaded, keyway
- Y9 .220" high, unthreaded, keyway

Terminations

- A (STD.) Right angle, PC thru-hole
- AV (STD.) Vertical right angle, PC thru-hole
- C (STD.) PC Thru-hole
- V3 (STD.) Vertical mount V-bracket
- Z (STD.) Solder lug
- W Wire wrap

Contact Material

- B (STD.) Gold
- Q (STD.) Silver
- K Gold
- M Silver
- G Gold over silver
- L Gold over silver

Seal

- E (STD.) Epoxy

Locking Lever Actuator Finish

- NONE (STD.) Natural aluminum
- 2 Black
- 3 Red
- 7 Blue

Specifications

CONTACT RATING: B contact material: 0.4 VA max. @ 20 V AC or DC max. Q contact material (TX01 models): 3 AMPS @ 120 V AC or 28 V DC. All other models: 2 AMPS @ 120 V AC or 28 V DC. See page A-45 for additional ratings.

ELECTRICAL LIFE: TX01 models: 60,000 make-and-break cycles at full load. All other models: 30,000 cycles.

CONTACT RESISTANCE: Below 20 milliohms typ. initial @ 2-4 V DC, 100 mA, for both silver and gold plated contacts.

INSULATION RESISTANCE: 10⁹ ohms min.

DIELECTRIC STRENGTH: 1000 V RMS min. @ sea level.

OPERATING TEMPERATURE: -30°C to 85°C.

SOLDERABILITY: Per MIL-STD-202F method 208D, or EIA RS-186E method 9 (1 hour steam aging).

NOTE: Specifications and materials listed above are for switches with standard options. For information on specific and custom switches, consult Customer Service Center.

Materials

CASE: Glass filled nylon 6/6, flame retardant, heat stabilized or diallyl phthalate (DAP), (UL 94V-0).

ACTUATOR: Brass, chrome plated.

BUSHING: Brass, nickel plated.

HOUSING: Stainless steel.

SWITCH SUPPORT: Brass, tin plated.

END CONTACTS: B contact material: Copper alloy, with gold plate over nickel plate. Q contact material: Coin silver, silver plated. See page A-45 for additional contact materials.

CENTER CONTACTS & TERMINALS: B contact material: Copper alloy, with gold plate over nickel plate. Q contact material: Copper alloy, silver plated. See page A-45 for additional contact materials.

TERMINAL SEAL: Epoxy.

HARDWARE: Nut & Locking Ring: Brass, nickel plated. Lockwasher: Steel, nickel plated.

T Series Subminiature Toggle Switches



SWITCHES WITH STANDARD OPTIONS



A

Toggle



T101SHZQE
SPDT

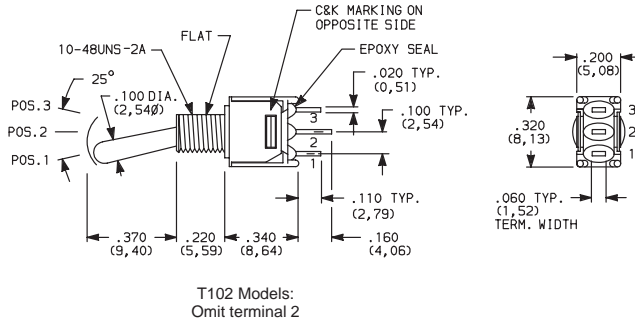

T102 Models:
Omit terminal 2

| PART NUMBER | NO. POLES | POS. 1 | POS. 2 | POS. 3 |
|-------------|-----------|--------|--------|--------|
| | | | | |
| T101SHZQE | SPDT | ON | NONE | ON |

NOTE: For PC termination, replace 'Z' with 'C'.
For panel mounting information, see page A-42.
For PC mounting information, see page A-43.



T201SHZQE
DPDT

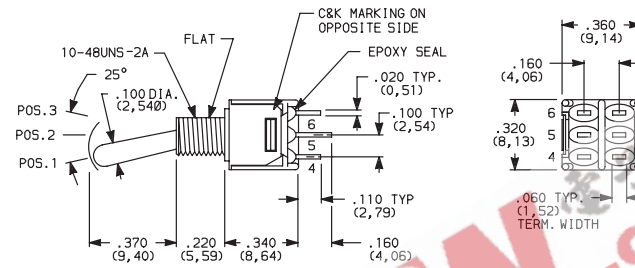

| PART NUMBER | NO. POLES | POS. 1 | POS. 2 | POS. 3 |
|-------------|-----------|--------|--------|--------|
| | | | | |
| T201SHZQE | DPDT | ON | NONE | ON |

NOTE: For PC termination, replace 'Z' with 'C'.
For panel mounting information, see page A-42.
For PC mounting information, see page A-43.



T101MH9ABE
Horizontal Actuation
SPDT

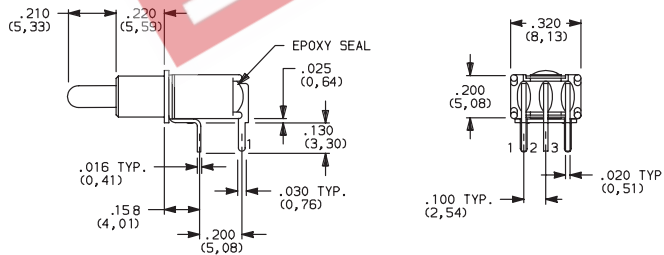

| PART NUMBER | NO. POLES | POS. 1 | POS. 2 | POS. 3 |
|-------------|-----------|--------|--------|--------|
| | | | | |
| T101MH9ABE | SPDT | ON | NONE | ON |
| T103MH9ABE | | ON | OFF | ON |
| T105MH9ABE | | MOM. | OFF | MOM. |
| T107MH9ABE | | ON | OFF | MOM. |
| T108MH9ABE | | ON | NONE | MOM. |

NOTE: For PC mounting information, see page A-43.
MOM. = Momentary

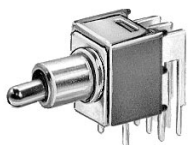

T201MH9ABE
Horizontal Actuation
DPDT

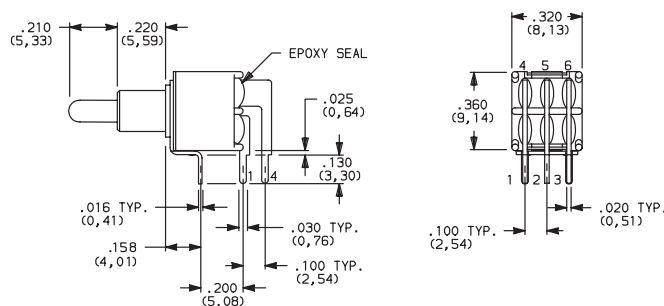

| PART NUMBER | NO. POLES | POS. 1 | POS. 2 | POS. 3 |
|-------------|-----------|--------|--------|--------|
| | | | | |
| T201MH9ABE | DPDT | ON | NONE | ON |

NOTE: For PC mounting information, see page A-43.



T Series Subminiature Toggle Switches

SWITCH WITH STANDARD OPTIONS

| PART NUMBER | NO. POLES | POS. 1 | POS. 2 | POS. 3 |
|--------------------|-----------|--------|--------|--------|
| T101MH9AVBE | SPDT | ON | NONE | ON |

NOTE: For PC mounting information, see page A-44.

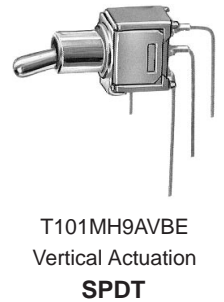
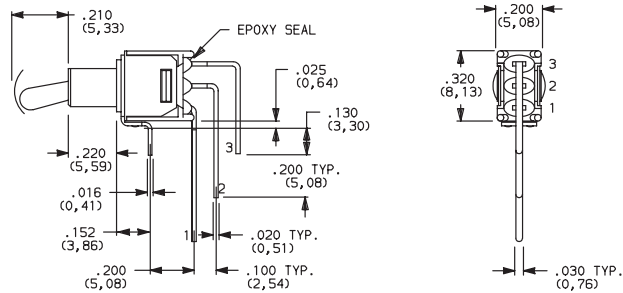

SWITCH FUNCTION

| NO. POLES | MODEL NO. | SWITCH FUNCTION | | | CONNECTED TERMINALS | | | SCHEMATIC |
|-----------|--------------------|-----------------|--------|--------|---------------------|---------|---------|-----------|
| | | POS. 1 | POS. 2 | POS. 3 | POS. 1 | POS. 2 | POS. 3 | |
| SP | T101 (STD.) | ON | NONE | ON | | | | |
| | T103 (STD.) | ON | OFF | ON | | | | |
| | T105 (STD.) | MOM. | OFF | MOM. | 2-3 | OPEN | 2-1 | |
| | T107 | ON | OFF | MOM. | | | | |
| | T108 | ON | NONE | MOM. | | | | |
| | T102 | OFF | NONE | ON | OPEN | N/A | 3-1 | |
| DP | T201 (STD.) | ON | NONE | ON | | | | |
| | T203 | ON | OFF | ON | | | | |
| | T205 | MOM. | OFF | MOM. | 2-3,5-6 | OPEN | 2-1,5-4 | |
| | T207 | ON | OFF | MOM. | | | | |
| | T208 | ON | NONE | MOM. | | | | |
| | T211* | ON | ON | ON | 2-3,5-6 | 2-3,5-4 | 2-1,5-4 | |

MOM. = Momentary

All models with all options when ordered with G, L, M or Q contact material.

* Wiring for 3-way switch, see page L-29.

ACTUATOR

M (STD.) .210" HIGH

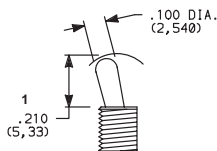

Standard with A, AV or V3 terminations.

S (STD.) .370" HIGH

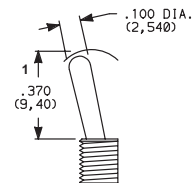

Standard with Z, C or W terminations.

M1 .220" HIGH

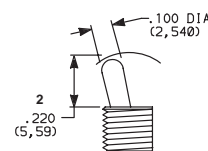

S1 .410" HIGH

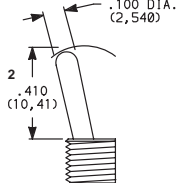

L .290" HIGH

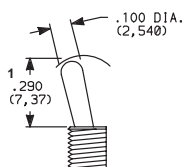

L1 .620" HIGH

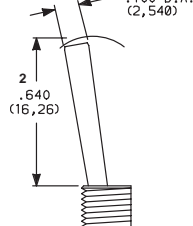

P3 (STD.) ANTI-ROTATION, FLATTED, .450" HIGH

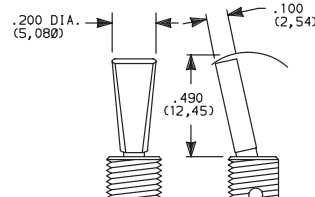

Available with T & T9 bushings only.

1 Actuator shown with standard H bushing. Subtract .040 (1,02) for TD and D9 bushings, subtract .090 (2,29) for T, T9, TK, K9 & CF bushings.

2 Actuators shown with T, TK & CF bushings, add .050 (1,27) for TD and D9 bushings, add .090 (2,29) for H, H9, Y & Y9 bushings.

NOTE: Dress nut part number 709901201 supplied standard with threaded bushing. All actuators have chrome finish (except K & K1). No finish selection required.

T Series Subminiature Toggle Switches



Toggle
A

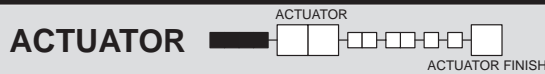

K LOCKING LEVER

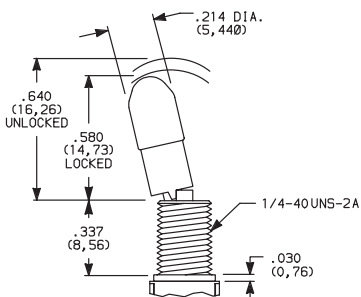

K1 LOCKING LEVER

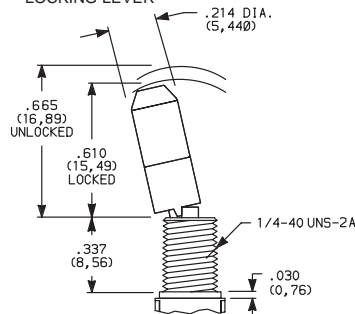

Locking Positions



-01 & -02 Models
2 Position lock



-03 & -11 Models
3 Position lock



-08 Models
1 Position lock

| OPTION CODE | K & K1 ACTUATOR CAP FINISH |
|-------------|----------------------------|
| NONE | (STD.) NATURAL AL. |
| 2 | BLACK ANODIZED AL. |
| 3 | RED ANODIZED AL. |
| 7 | BLUE ANODIZED AL. |

Not available with CF bushing option.

NOTE: Keyway on right side. To prevent accidental actuation, toggles must be lifted before being actuated. When released, toggles again lock in place. Overtightening mounting nut may cause actuator to bind.

Bushing option code not required. Not available with TX05 & TX07 models.

BUSHING

H (STD.) .220" HIGH THREADED, FLAT

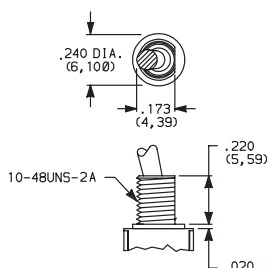

H standard with C, W & Z terminations.
H9 standard with A, AV & V3 terminations.

Y .220" HIGH THREADED, KEYWAY

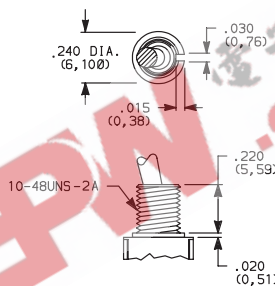

T .310" HIGH THREADED, FLAT

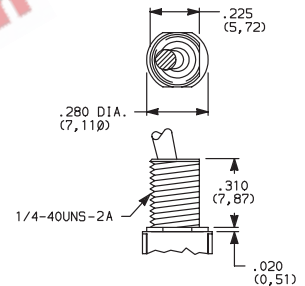

TK .310" HIGH THREADED, KEYWAY

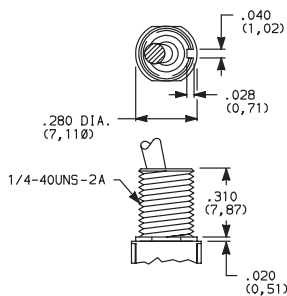

K9 .310" HIGH UNTHREADED, KEYWAY

TD .260" HIGH THREADED, KEYWAY

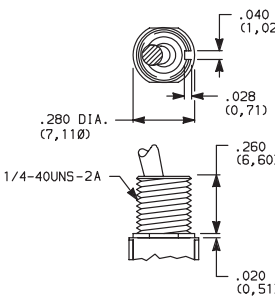

D9 .260" HIGH UNTHREADED, KEYWAY

CF SPLASHPROOF, .310" HIGH THREADED, FLAT

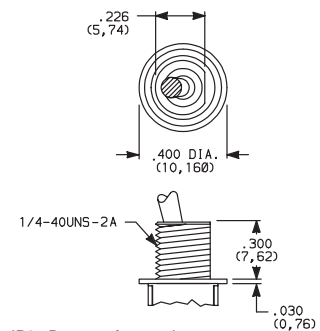

IP67 Degree of protection.
Internal o-ring actuator seal and external bushing seal washer standard.

Not available with K locking lever option.

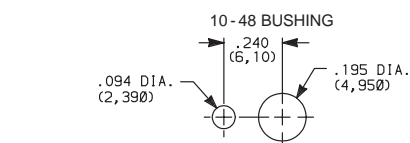

With Standard Locking Ring

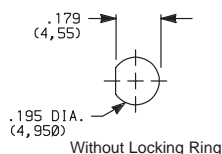

Without Locking Ring

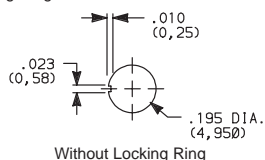

Without Locking Ring

PANEL MOUNTING

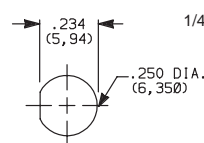

With Standard Locking Ring

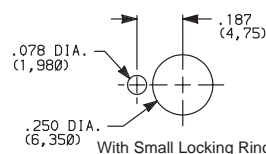

With Small Locking Ring

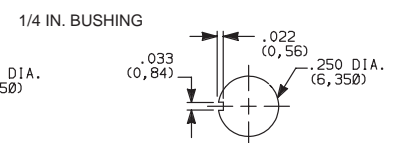

With Standard Locking Ring

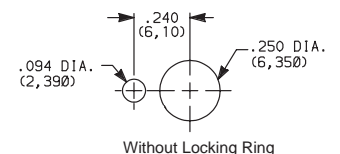

Without Locking Ring

TERMINATIONS



Z (STD.) SOLDER LUG

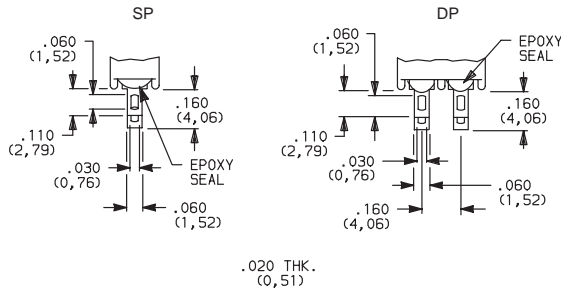

Not available with K, L or M contact materials.

C (STD.) PC THRU-HOLE

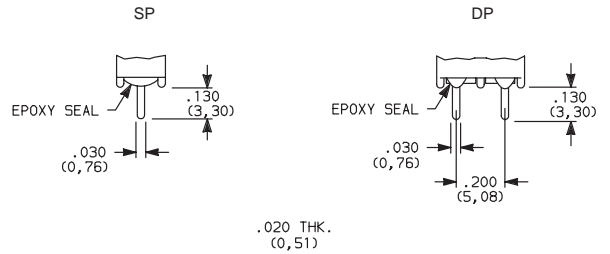

W WIRE WRAP

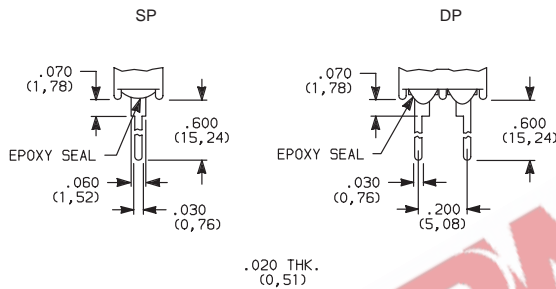

PC MOUNTING

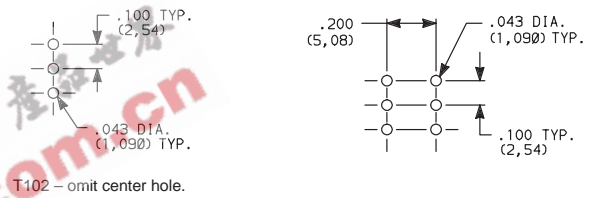

A (STD.) RIGHT ANGLE, PC THRU-HOLE

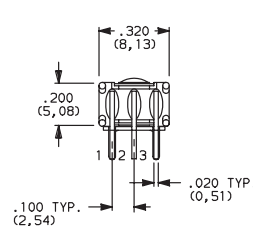
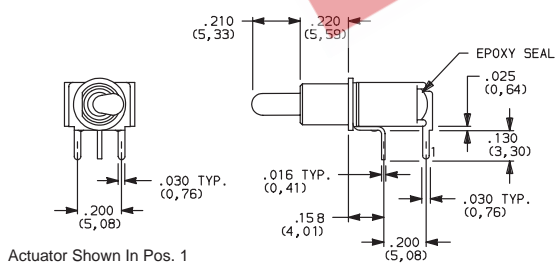

PC MOUNTING

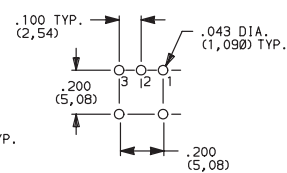

T101MH9ABE
Horizontal Actuation
SPDT

Not available with T102 model.

A (STD.) RIGHT ANGLE, PC THRU-HOLE

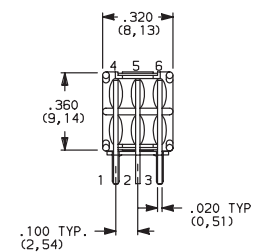
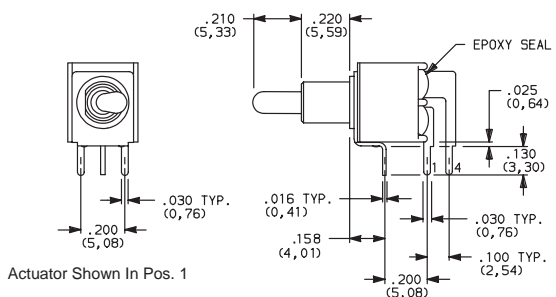

PC MOUNTING

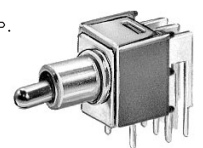
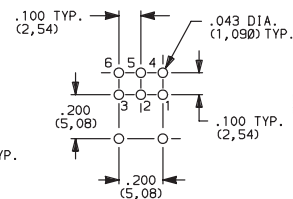

T201MH9ABE
Horizontal Actuation
DPDT

T Series Subminiature Toggle Switches



TERMINATIONS

AV (STD.) VERTICAL RIGHT ANGLE, PC THRU-HOLE

Toggle
A

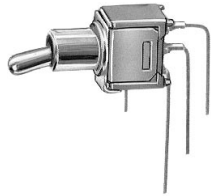

T101MH9AVBE
Vertical Actuation
SPDT

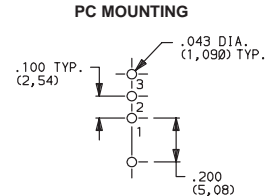
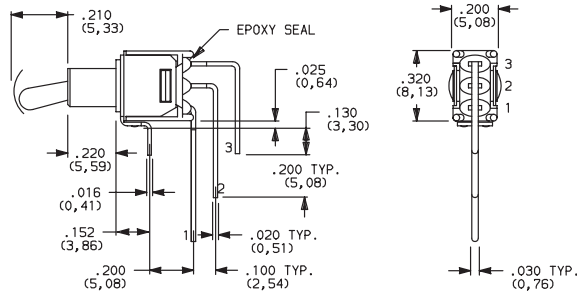
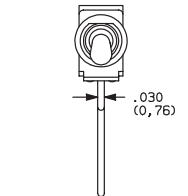

NOTE: Terminal bend radii and lead-in manufacturing option.

AV (STD.) VERTICAL RIGHT ANGLE, PC THRU-HOLE

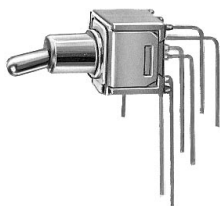

T201MH9AVBE
Vertical Actuation
DPDT

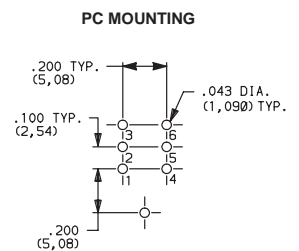
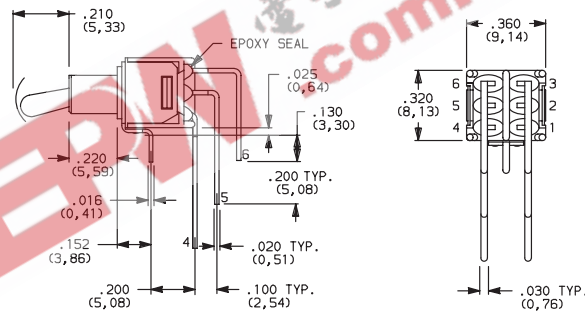
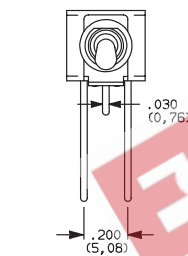

NOTE: Terminal bend radii and lead-in manufacturing option.

V3 (STD.) VERTICAL MOUNT, V-BRACKET



T101MH9V3BE
SPDT

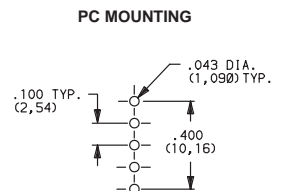
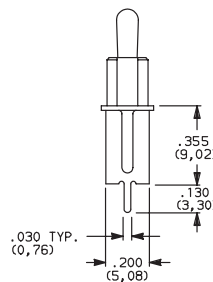
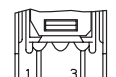
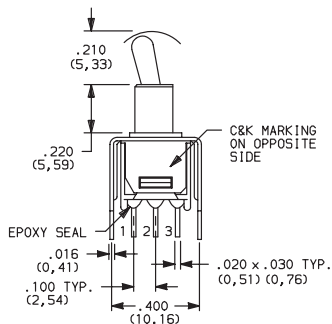

T102 Models:
Omit center hole.

TERMINATIONS

V3 (STD.) VERTICAL MOUNT, V-BRACKET



T201MH9V3BE
DPDT

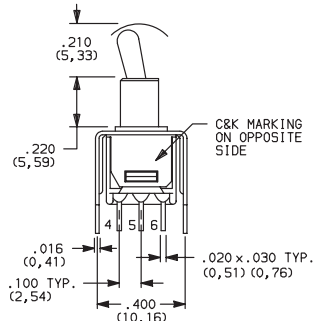

Actuator Shown In Pos. 1

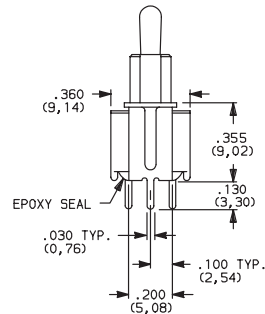

PC MOUNTING

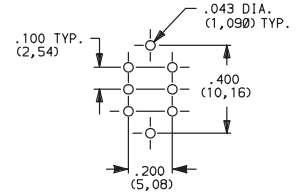

CONTACT MATERIAL

| OPTION CODE | CONTACT MATERIAL | TERMINAL PLATING | RATINGS | |
|-----------------|---------------------------------|-----------------------|----------------------------------|--|
| B (STD.) | GOLD ¹ | GOLD ¹ | LOW LEVEL / DRY CIRCUIT | 0.4 VA MAX. @ 20 V AC OR DC MAX. |
| K | | TIN-LEAD ⁶ | | |
| Q (STD.) | SILVER ^{4,5} | SILVER ⁵ | POWER | TX01 MODELS: 3 AMPS @ 120 V AC OR 28 V DC. ALL OTHER MODELS: 2 AMPS @ 120 V AC OR 28 V DC. |
| M | | TIN-LEAD ⁶ | | |
| G | GOLD OVER SILVER ^{2,3} | GOLD ³ | LOW LEVEL / DRY CIRCUIT OR POWER | TX01 MODELS: 0.4 VA MAX @ 20 V AC OR DC MAX. OR 3 AMPS @ 120 V AC OR 28 V DC. ALL OTHER MODELS: 0.4 VA MAX. @ 20 V AC OR DC MAX. OR 2 AMPS @ 120 V AC OR 28 V DC. |
| L | | TIN-LEAD ⁶ | | |

CONTACT MATERIAL / APPLICATION RECOMMENDATIONS—SEE CHART, PAGE L-31.

¹ CONTACTS & TERMINALS: Copper alloy, with gold plate over nickel plate.

² END CONTACTS: Coin silver, with gold plate over nickel plate.

³ CENTER CONTACTS & ALL TERMINALS: Copper alloy, with gold plate over nickel plate.

⁴ END CONTACTS: Coin silver, silver plated.

⁵ CENTER CONTACT & ALL TERMINALS: Copper alloy, silver plated.

⁶ TERMINALS: Copper alloy, with tin-lead alloy over nickel plate.

All models with all options when ordered with G, L, M or Q contact material.

B contact material standard with A, AV, V3 & W terminations.

Q contact material standard with C & Z terminations.

SEAL

E (STD.) EPOXY SEAL

