

# T2800D

## Triacs

### Silicon Bidirectional Thyristors

Designed primarily for full-wave ac control applications, such as light dimmers, motor controls, heating controls and power supplies.

#### Features

- Blocking Voltage to 400 V
- All Diffused and Glass Passivated Junctions for Greater Parameter Uniformity and Stability
- Small, Rugged, Thermowatt Construction for Low Thermal Resistance, High Heat Dissipation and Durability
- Four Quadrant Gating
- Pb-Free Package is Available\*

#### MAXIMUM RATINGS (T<sub>J</sub> = 25°C unless otherwise noted)

Rating	Symbol	Value	Unit
Peak Repetitive Off-State Voltage (Note 1) (T <sub>J</sub> = -40 to +125°C, Gate Open)	V <sub>DRM</sub> , V <sub>RRM</sub>	400	V
On-State RMS Current (All Conduction Angles, T <sub>C</sub> = +80°C)	I <sub>T(RMS)</sub>	8.0	A
Peak Non-Repetitive Surge Current (One Full Cycle Sine Wave, 60 Hz, T <sub>J</sub> = +80°C)	I <sub>TSM</sub>	100	A
Circuit Fusing Consideration (t = 8.3 ms)	I <sup>2</sup> t	40	A <sup>2</sup> s
Peak Gate Power (Pulse Width = 10 μs, T <sub>C</sub> = +80°C)	P <sub>GM</sub>	16	W
Average Gate Power (t = 8.3 ms, T <sub>C</sub> = +80°C)	P <sub>G(AV)</sub>	0.35	W
Peak Gate Current (Pulse Width = 10 μs, T <sub>C</sub> = +80°C)	I <sub>GM</sub>	4.0	A
Operating Junction Temperature Range	T <sub>J</sub>	-40 to +125	°C
Storage Temperature Range	T <sub>stg</sub>	-40 to +150	°C

Stresses exceeding Maximum Ratings may damage the device. Maximum Ratings are stress ratings only. Functional operation above the Recommended Operating Conditions is not implied. Extended exposure to stresses above the Recommended Operating Conditions may affect device reliability.

1. V<sub>DRM</sub> and V<sub>RRM</sub> for all types can be applied on a continuous basis. Blocking voltages shall not be tested with a constant current source such that the voltage ratings of the devices are exceeded.



**ON Semiconductor®**

<http://onsemi.com>

### TRIACS 8 AMPERES RMS, 400 VOLTS

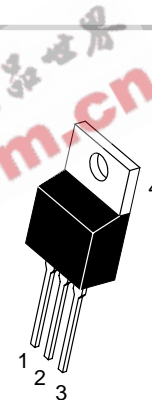
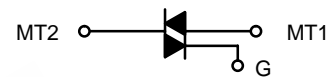

**TO-220AB  
CASE 221A  
STYLE 4**

#### MARKING DIAGRAM

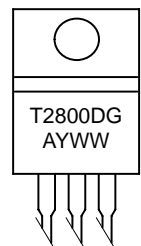

A = Assembly Location  
Y = Year  
WW = Work Week  
G = Pb-Free Package

#### PIN ASSIGNMENT

1	Main Terminal 1
2	Main Terminal 2
3	Gate
4	Main Terminal 2

#### ORDERING INFORMATION

Device	Package	Shipping
T2800D	TO-220AB	500 Units/Box
T2800DG	TO-220AB (Pb-Free)	500 Units/Box

\*For additional information on our Pb-Free strategy and soldering details, please download the ON Semiconductor Soldering and Mounting Techniques Reference Manual, SOLDERRM/D.

# T2800D

## THERMAL CHARACTERISTICS

Characteristic	Symbol	Value	Unit
Thermal Resistance, Junction-to-Case	$R_{\theta JC}$	2.2	$^{\circ}C/W$
Maximum Lead Temperature for Soldering Purposes 1/8" from Case for 10 Sec	$T_L$	260	$^{\circ}C$

## ELECTRICAL CHARACTERISTICS ( $T_C = 25^{\circ}C$ unless otherwise noted; Electricals apply in both directions)

Characteristic	Symbol	Min	Typ	Max	Unit
----------------	--------	-----	-----	-----	------

### OFF CHARACTERISTICS

Peak Repetitive Blocking Current ( $V_D = \text{Rated } V_{DRM}, V_{RRM}; \text{ Gate Open}$ )	$I_{DRM}, I_{RRM}$	-	-	10	$\mu A$
		-	-	2.0	mA
					$T_C = 25^{\circ}C$
					$T_C = 100^{\circ}C$

### ON CHARACTERISTICS

Peak On-State Voltage (Note 2) ( $I_T = \pm 30 A \text{ Peak}$ )	$V_{TM}$	-	1.7	2.0	V
Gate Trigger Current (Continuous dc) ( $V_D = 12 Vdc, R_L = 100 \Omega$ )	$I_{GT}$				mA
	MT2(+), G(+)	-	10	25	
	MT2(+), G(-)	-	20	60	
	MT2(-), G(-)	-	15	25	
	MT2(-), G(+)	-	30	60	
Gate Trigger Voltage (Continuous dc) (All Quadrants) ( $V_D = 12 Vdc, R_L = 100 \Omega$ )	$V_{GT}$	-	1.25	2.5	V
Gate Non-Trigger Voltage (Continuous dc) ( $V_D = 12 V, R_L = 100 \Omega, T_C = 100^{\circ}C$ )	$V_{GD}$	0.2	-	-	V
Holding Current ( $V_D = 12 Vdc, \text{ Initiating Current} = \pm 200 mA, \text{ Gate Open}$ )	$I_H$	-	15	30	mA
Gate Controlled Turn-On Time ( $V_D = \text{Rated } V_{DRM}, I_T = 10 A, I_{GT} = 80 mA, \text{ Rise Time} = 0.1 \mu s$ )	$t_{gt}$	-	1.6	-	$\mu s$

### DYNAMIC CHARACTERISTICS

Critical Rate-of-Rise of Commutation Voltage ( $V_D = \text{Rated } V_{DRM}, I_{T(RMS)} = 8 A, \text{ Commutating } di/dt = 4.1 A/ms, \text{ Gate Unenergized}, T_C = 80^{\circ}C$ )	$dv/dt(c)$	-	10	-	$V/\mu s$
Critical Rate-of-Rise of Off-State Voltage ( $V_D = \text{Rated } V_{DRM}, \text{ Exponential Voltage Rise, Gate Open}, T_C = 100^{\circ}C$ )	$dv/dt$	60	-	-	$V/\mu s$

2. Pulse Test: Pulse Width  $\leq 2.0 ms$ , Duty Cycle  $\leq 2\%$ .

## Voltage Current Characteristic of Triacs (Bidirectional Device)

Symbol	Parameter
$V_{DRM}$	Peak Repetitive Forward Off State Voltage
$I_{DRM}$	Peak Forward Blocking Current
$V_{RRM}$	Peak Repetitive Reverse Off State Voltage
$I_{RRM}$	Peak Reverse Blocking Current
$V_{TM}$	Maximum On State Voltage
$I_H$	Holding Current

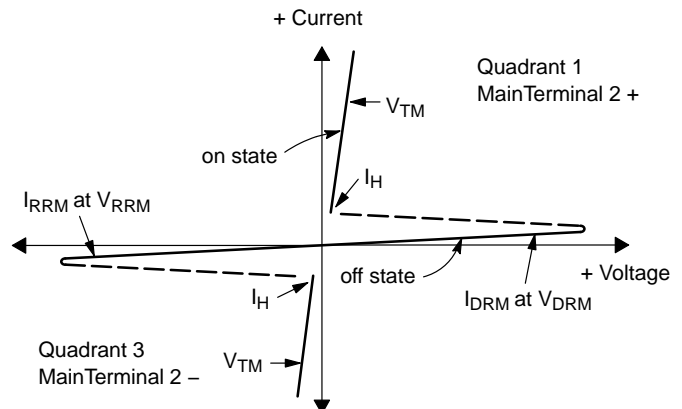

# T2800D

## Quadrant Definitions for a Triac

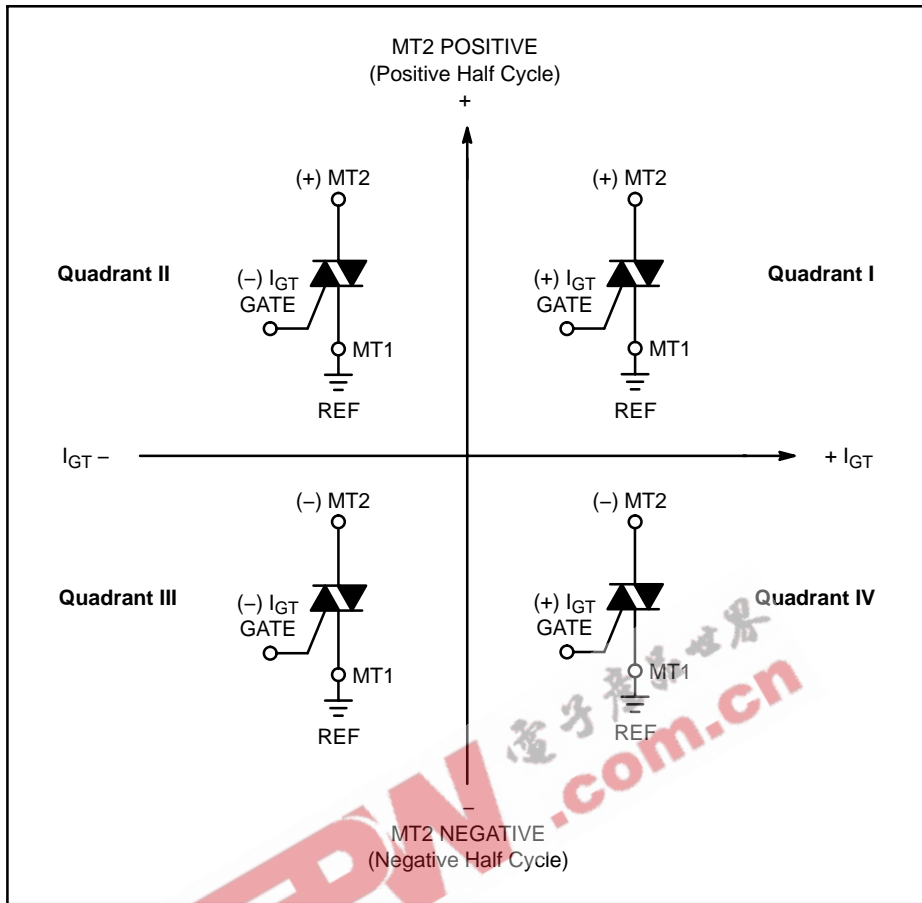

All polarities are referenced to MT1.  
 With in-phase signals (using standard AC lines) quadrants I and III are used.

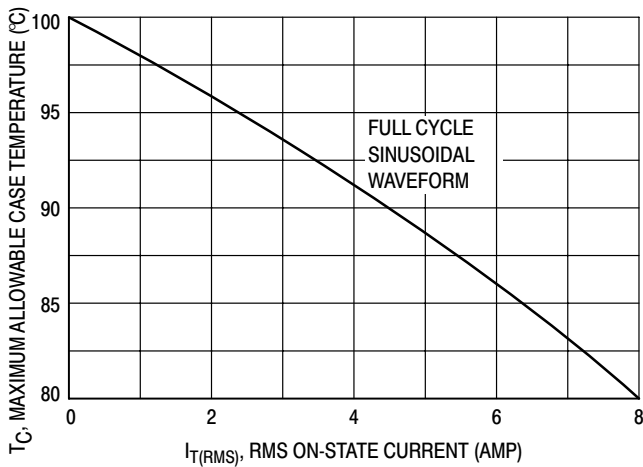

Figure 1. Current Derating

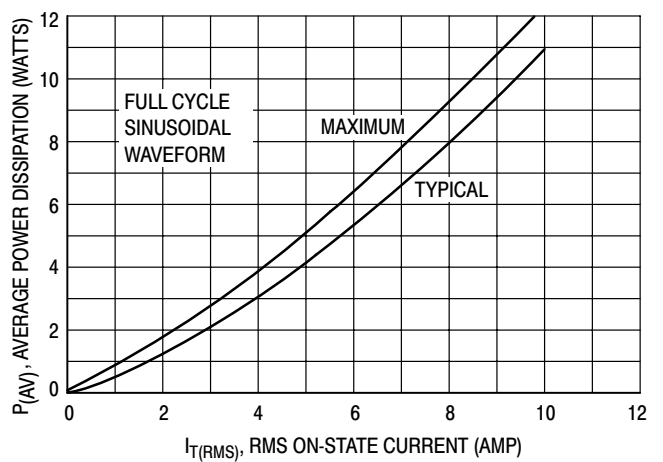
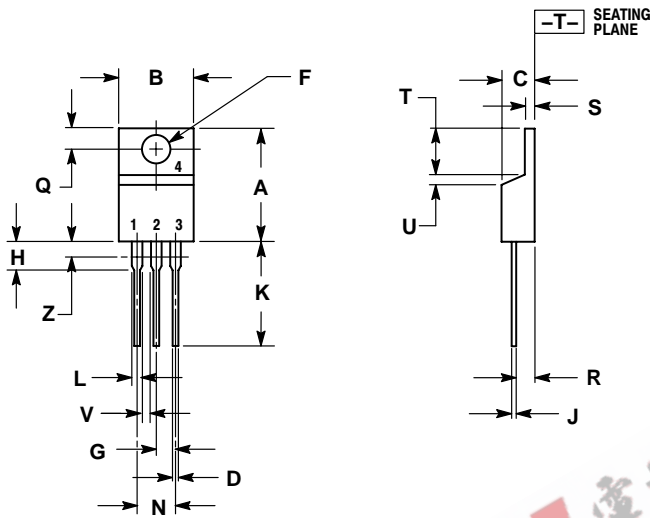

Figure 2. Power Dissipation

# T2800D

## PACKAGE DIMENSIONS

TO-220  
CASE 221A-07  
ISSUE AA



- NOTES:
1. DIMENSIONING AND TOLERANCING PER ANSI Y14.5M, 1982.
  2. CONTROLLING DIMENSION: INCH.
  3. DIMENSION Z DEFINES A ZONE WHERE ALL BODY AND LEAD IRREGULARITIES ARE ALLOWED.

DIM	INCHES		MILLIMETERS	
	MIN	MAX	MIN	MAX
A	0.570	0.620	14.48	15.75
B	0.380	0.405	9.66	10.28
C	0.160	0.190	4.07	4.82
D	0.025	0.035	0.64	0.88
F	0.142	0.147	3.61	3.73
G	0.095	0.105	2.42	2.66
H	0.110	0.155	2.80	3.93
J	0.014	0.022	0.36	0.55
K	0.500	0.562	12.70	14.27
L	0.045	0.060	1.15	1.52
N	0.190	0.210	4.83	5.33
Q	0.100	0.120	2.54	3.04
R	0.080	0.110	2.04	2.79
S	0.045	0.055	1.15	1.39
T	0.235	0.255	5.97	6.47
U	0.000	0.050	0.00	1.27
V	0.045	---	1.15	---
Z	---	0.080	---	2.04

- STYLE 4:
1. MAIN TERMINAL 1
  2. MAIN TERMINAL 2
  3. GATE
  4. MAIN TERMINAL 2

ON Semiconductor and are registered trademarks of Semiconductor Components Industries, LLC (SCILLC). SCILLC reserves the right to make changes without further notice to any products herein. SCILLC makes no warranty, representation or guarantee regarding the suitability of its products for any particular purpose, nor does SCILLC assume any liability arising out of the application or use of any product or circuit, and specifically disclaims any and all liability, including without limitation special, consequential or incidental damages. "Typical" parameters which may be provided in SCILLC data sheets and/or specifications can and do vary in different applications and actual performance may vary over time. All operating parameters, including "Typicals" must be validated for each customer application by customer's technical experts. SCILLC does not convey any license under its patent rights nor the rights of others. SCILLC products are not designed, intended, or authorized for use as components in systems intended for surgical implant into the body, or other applications intended to support or sustain life, or for any other application in which the failure of the SCILLC product could create a situation where personal injury or death may occur. Should Buyer purchase or use SCILLC products for any such unintended or unauthorized application, Buyer shall indemnify and hold SCILLC and its officers, employees, subsidiaries, affiliates, and distributors harmless against all claims, costs, damages, and expenses, and reasonable attorney fees arising out of, directly or indirectly, any claim of personal injury or death associated with such unintended or unauthorized use, even if such claim alleges that SCILLC was negligent regarding the design or manufacture of the part. SCILLC is an Equal Opportunity/Affirmative Action Employer. This literature is subject to all applicable copyright laws and is not for resale in any manner.

### PUBLICATION ORDERING INFORMATION

**LITERATURE FULFILLMENT:**  
Literature Distribution Center for ON Semiconductor  
P.O. Box 5163, Denver, Colorado 80217 USA  
**Phone:** 303-675-2175 or 800-344-3860 Toll Free USA/Canada  
**Fax:** 303-675-2176 or 800-344-3867 Toll Free USA/Canada  
**Email:** orderlit@onsemi.com

**N. American Technical Support:** 800-282-9855 Toll Free USA/Canada  
**Europe, Middle East and Africa Technical Support:**  
Phone: 421 33 790 2910  
**Japan Customer Focus Center**  
Phone: 81-3-5773-3850

**ON Semiconductor Website:** [www.onsemi.com](http://www.onsemi.com)  
**Order Literature:** <http://www.onsemi.com/orderlit>  
For additional information, please contact your local Sales Representative