

Table 1: Main Features

Symbol	Value	Unit
$I_{T(RMS)}$	12	A
V_{DRM}/V_{RRM}	600	V
$I_{GT}(Q_1)$	35	mA

DESCRIPTION

Specifically designed for use in high temperature environment (found in hot appliances such as cookers, ovens, hobs, electric heaters, coffee machines...), the new 12 Amps **T1235H** triacs provide an enhanced performance in terms of power loss and thermal dissipation. This allows for optimization of the heatsinking dimensioning, leading to space and cost effectiveness when compared to electro-mechanical solutions.

Based on ST snubberless technology, they offer high commutation switching capabilities and high noise immunity levels. And, thanks to their clip assembly technique, they provide a superior performance in surge current handling.

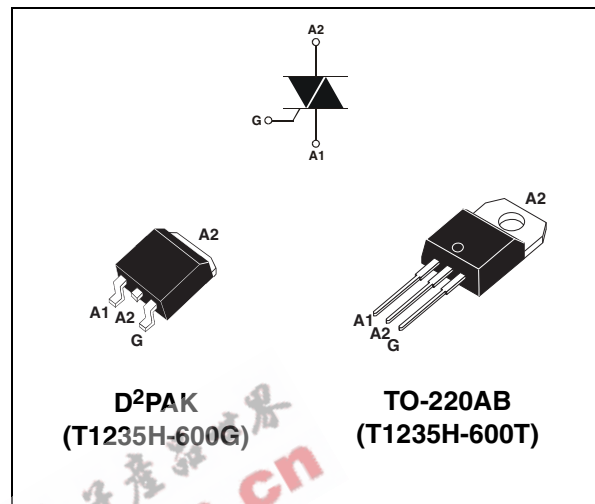

Table 2: Order Codes

Part Number	Marking
T1235H-600G	T1235H600G
T1235H-600G-TR	T1235H600G
T1235H-600TRG	T1235H600T

Table 3: Absolute Maximum Ratings

Symbol	Parameter		Value	Unit	
$I_{T(RMS)}$	RMS on-state current (full sine wave)		$T_c = 135^\circ\text{C}$	12	A
I_{TSM}	Non repetitive surge peak on-state current (full cycle, T_j initial = 25°C)	F = 50 Hz	t = 20 ms	140	A
		F = 60 Hz	t = 16.7 ms	145	
I^2t	I^2t Value for fusing	$t_p = 10$ ms		112	A^2s
di/dt	Critical rate of rise of on-state current $I_G = 2 \times I_{GT}$, $t_r \leq 100$ ns	F = 120 Hz	$T_j = 150^\circ\text{C}$	50	A/ μs
V_{DSM}/V_{RSM}	Non repetitive surge peak off-state voltage	$t_p = 10$ ms	$T_j = 25^\circ\text{C}$	700	V
I_{GM}	Peak gate current	$t_p = 20$ μs	$T_j = 150^\circ\text{C}$	4	A
$P_{G(AV)}$	Average gate power dissipation	$T_j = 150^\circ\text{C}$		1	W
T_{stg} T_j	Storage junction temperature range Operating junction temperature range		- 40 to + 150 - 40 to + 150		$^\circ\text{C}$

T1235H

Tables 4: Electrical Characteristics ($T_j = 25^\circ\text{C}$, unless otherwise specified)

Symbol	Test Conditions	Quadrant		Value	Unit
I_{GT} (1)	$V_D = 12\text{ V}$ $R_L = 33\ \Omega$	I - II - III	MAX.	35	mA
V_{GT}		I - II - III	MAX.	1.3	V
V_{GD}	$V_D = V_{DRM}$ $R_L = 3.3\ \text{k}\Omega$ $T_j = 150^\circ\text{C}$	I - II - III	MIN.	0.15	V
I_H (2)	$I_T = 100\ \text{mA}$		MAX.	35	mA
I_L	$I_G = 1.2 I_{GT}$	I - III	MAX.	50	mA
		II		80	
dV/dt (2)	$V_D = 67\ \%V_{DRM}$ gate open $T_j = 150^\circ\text{C}$		MIN.	300	V/ μs
$(dI/dt)_c$ (2)	Without snubber $T_j = 150^\circ\text{C}$		MIN.	5.3	A/ms

Table 5: Static Characteristics

Symbol	Test Conditions			Value	Unit	
V_T (2)	$I_{TM} = 17\ \text{A}$	$t_p = 380\ \mu\text{s}$	$T_j = 25^\circ\text{C}$	MAX.	1.55	V
V_{to} (2)	Threshold voltage		$T_j = 150^\circ\text{C}$	MAX.	0.80	V
R_d (2)	Dynamic resistance		$T_j = 150^\circ\text{C}$	MAX.	25	m Ω
I_{DRM} I_{RRM}	$V_{DRM} = V_{RRM}$		$T_j = 25^\circ\text{C}$	MAX.	5	μA
			$T_j = 150^\circ\text{C}$		5.5	mA
	$V_{DRM}/V_{RRM} = 400\text{V}$ (at mains peak voltage)	$T_j = 150^\circ\text{C}$	3.5			

Note 1: minimum I_{GT} is guaranteed at 10% of I_{GT} max.

Note 2: for both polarities of A2 referenced to A1.

Table 6: Thermal resistance

Symbol	Parameter		Value	Unit	
$R_{th(j-c)}$	Junction to case (AC)		D ² PAK	1.2	$^\circ\text{C}/\text{W}$
			TO-220AB		
$R_{th(j-a)}$	Junction to ambient	S = 1 cm ²	D ² PAK	45	$^\circ\text{C}/\text{W}$
			TO-220AB	60	

S = Copper surface under tab.

Figure 1: Maximum power dissipation versus RMS on-state current (full cycle)

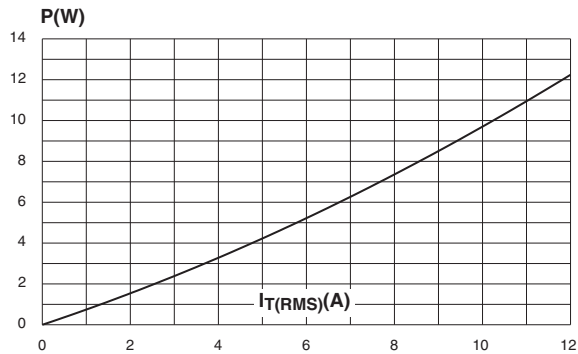

Figure 2: RMS on-state current versus case temperature (full cycle)

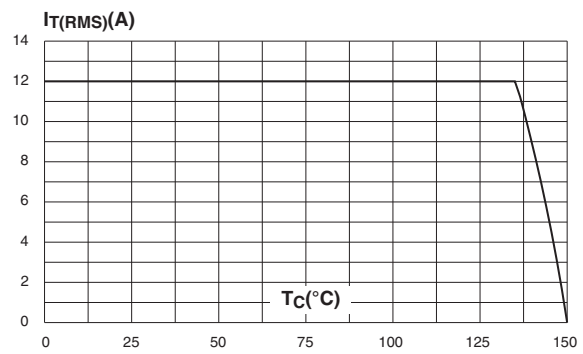

Figure 3: RMS on-state current versus ambient temperature (printed circuit board FR4, copper thickness: 35µm) (full cycle)

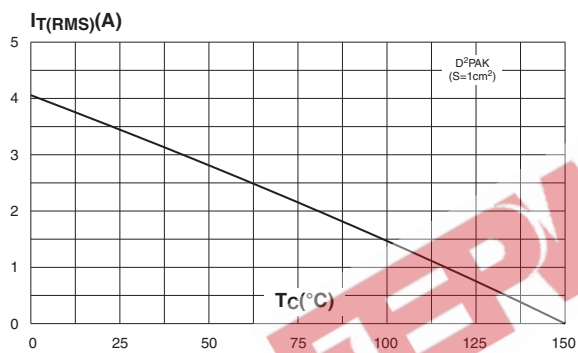

Figure 4: Relative variation of thermal impedance versus pulse duration

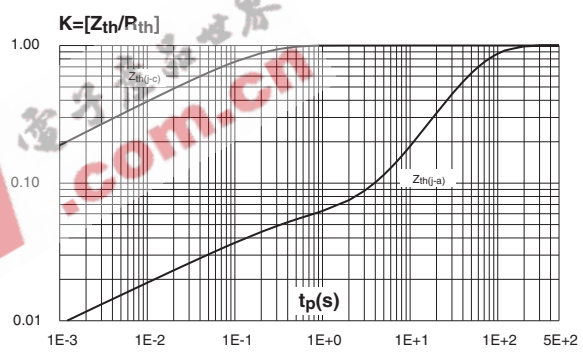

Figure 5: On-state characteristics (maximum values)

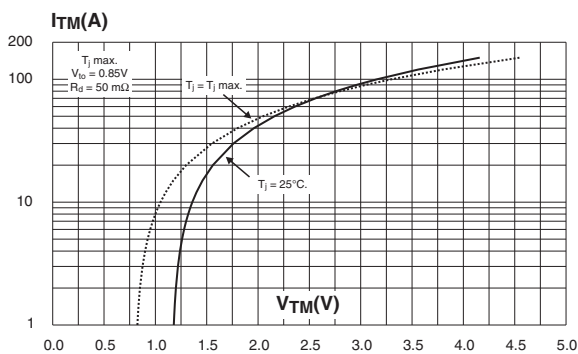

Figure 6: Surge peak on-state current versus number of cycles

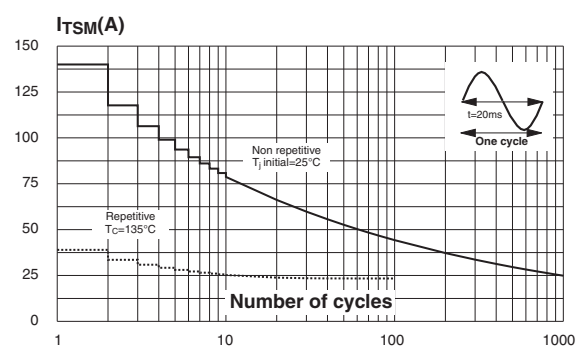

Figure 7: Non-repetitive surge peak on-state current for a sinusoidal pulse with width $t_p < 10$ ms and corresponding value of I^2t

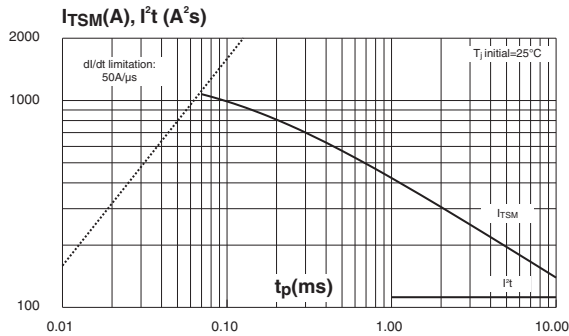

Figure 8: Relative variation of gate trigger current, holding current and latching current versus junction temperature (typical values)

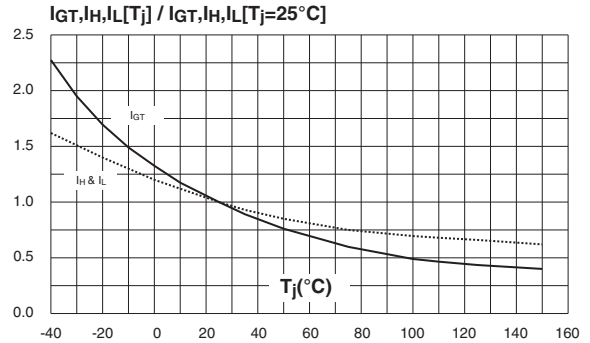

Figure 9: Relative variation of critical rate of decrease of main current versus $(dV/dt)_c$ (typical values)

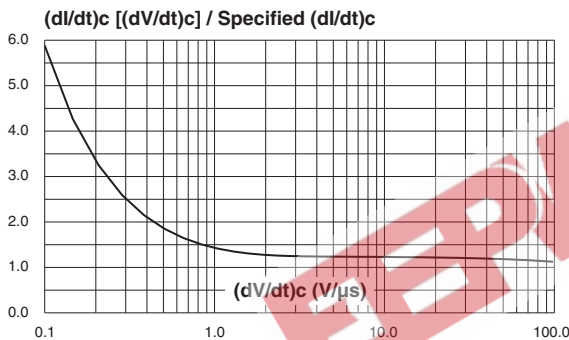

Figure 10: Relative variation of critical rate of decrease of main current versus junction temperature

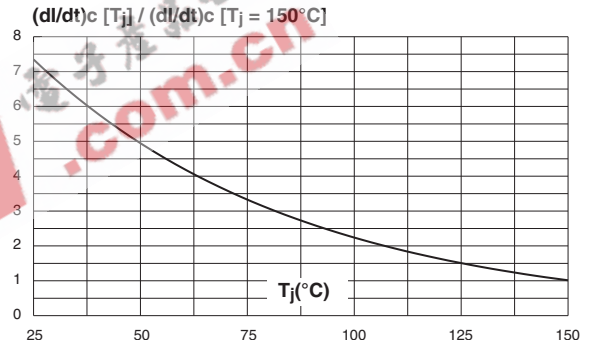

Figure 11: Leakage current versus junction temperature for different values of blocking voltage (typical values)

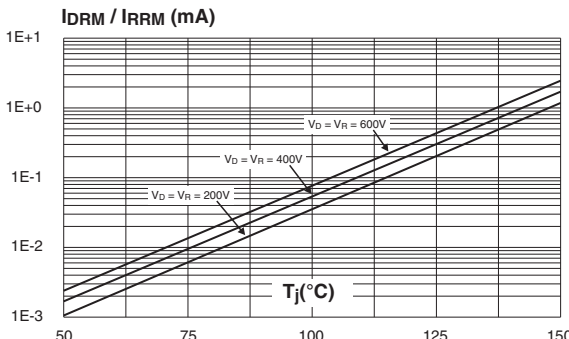

Figure 12: Acceptable repetitive peak off-state voltage versus case-ambient thermal resistance

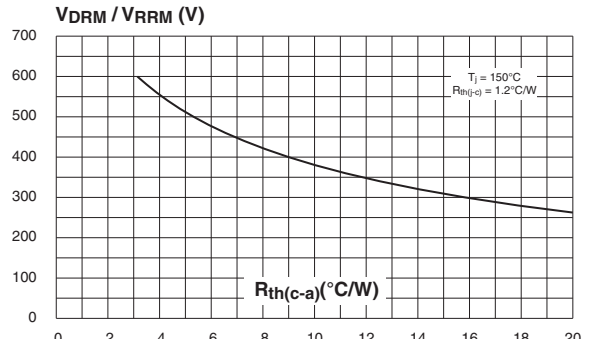

Figure 13: D²PAK Thermal resistance junction to ambient versus copper surface under tab (printed circuit board FR4, copper thickness: 35 μm)

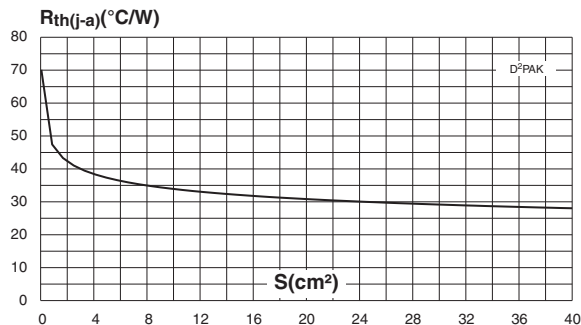

Figure 14: Ordering Information Scheme

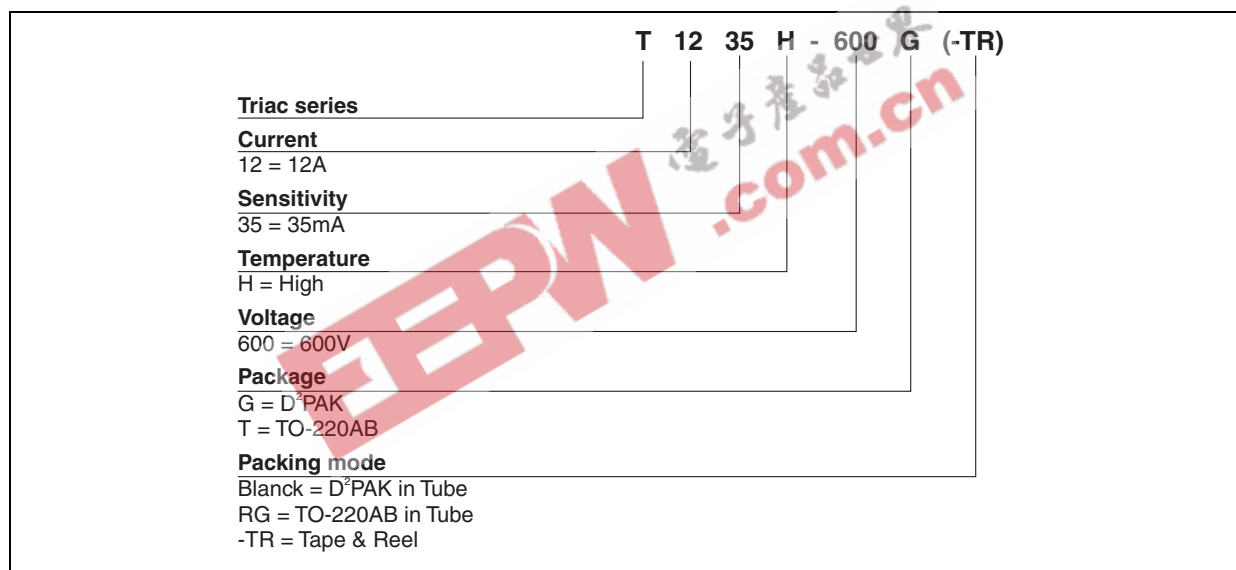

Table 7: Product Selector

Part Numbers	Voltage	Sensitivity	Type	Package
T1235H-600G	600 V	35 mA	Snubberless	D ² PAK
T1235H-600T	600 V	35 mA	Snubberless	TO-220AB

Figure 15: D²PAK Package Mechanical Data

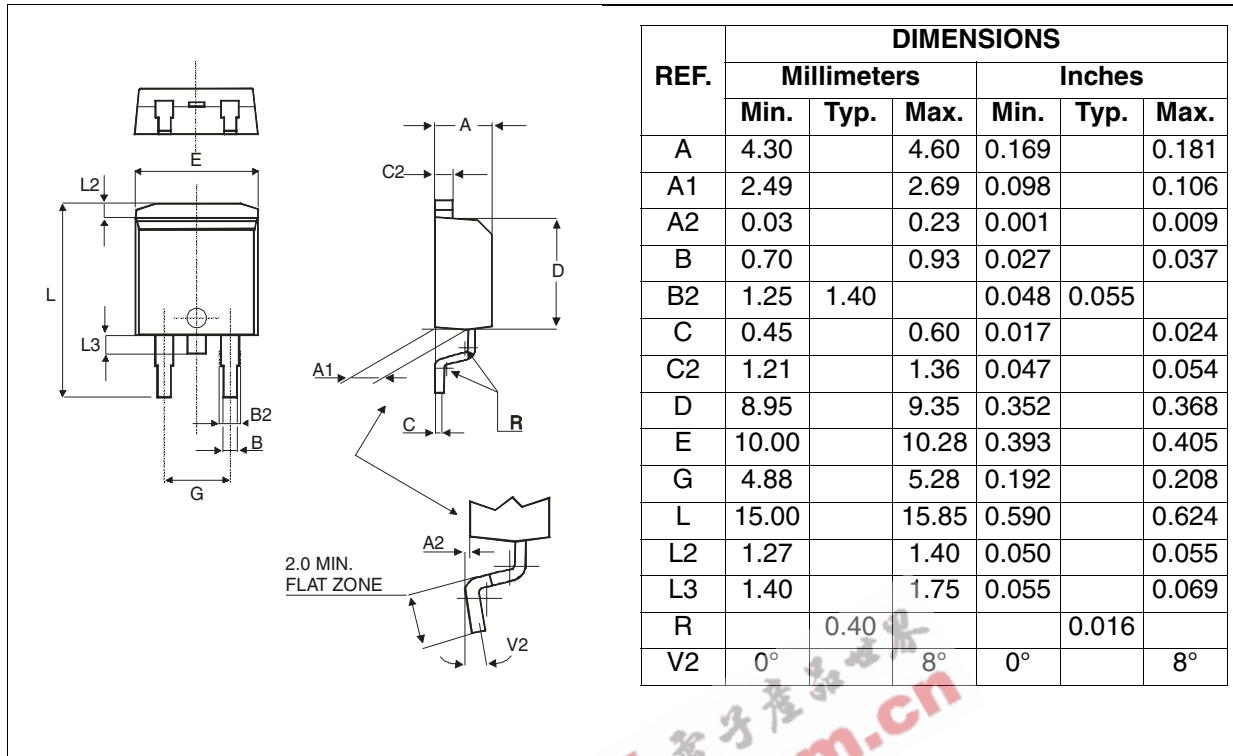

Figure 16: D²PAK Foot Print Dimensions (in millimeters)

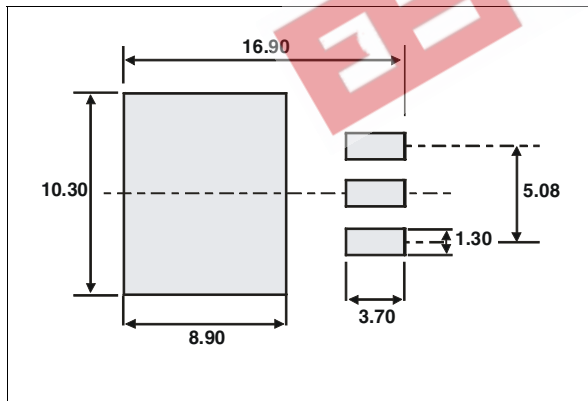
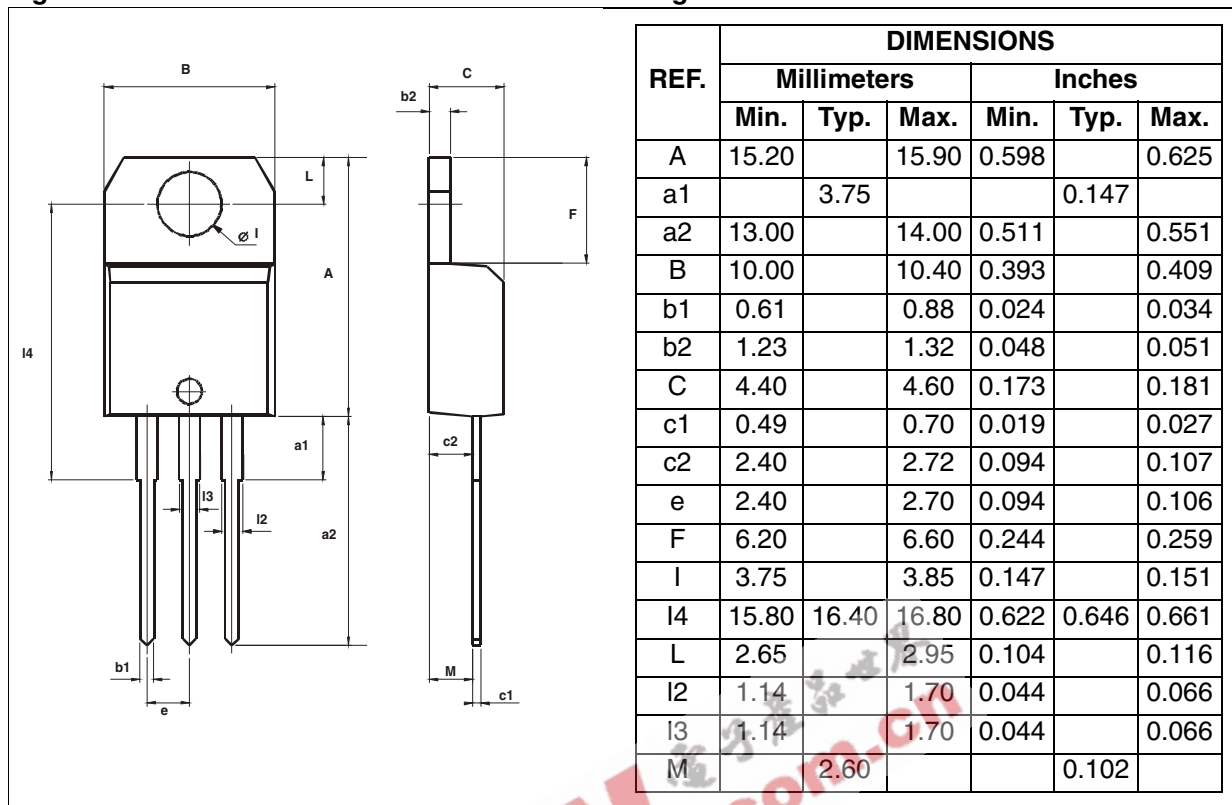

Figure 17: TO-220AB and TO-220AB Insulated Package Mechanical Data



In order to meet environmental requirements, ST offers these devices in ECOPACK® packages. These packages have a Lead-free second level interconnect. The category of second level interconnect is marked on the package and on the inner box label, in compliance with JEDEC Standard JESD97. The maximum ratings related to soldering conditions are also marked on the inner box label. ECOPACK is an ST trademark. ECOPACK specifications are available at: www.st.com.

Table 8: Ordering Information

Ordering type	Marking	Package	Weight	Base qty	Delivery mode
T1235H-600TRG	T1235H600T	TO-220AB	2.3 g	50	Tube
T1235H-600G	T1235H600G	D ² PAK	1.5 g	50	Tube
T1235H-600G-TR	T1235H600G			1000	Tape & reel

Table 9: Revision History

Date	Revision	Description of Changes
Apr-2002	5A	Last update.
13-Feb-2006	6	TO-220AB delivery mode changed from bulk to tube. ECOPACK statement added.



Information furnished is believed to be accurate and reliable. However, STMicroelectronics assumes no responsibility for the consequences of use of such information nor for any infringement of patents or other rights of third parties which may result from its use. No license is granted by implication or otherwise under any patent or patent rights of STMicroelectronics. Specifications mentioned in this publication are subject to change without notice. This publication supersedes and replaces all information previously supplied. STMicroelectronics products are not authorized for use as critical components in life support devices or systems without express written approval of STMicroelectronics.

The ST logo is a registered trademark of STMicroelectronics.
All other names are the property of their respective owners

© 2006 STMicroelectronics - All rights reserved

STMicroelectronics group of companies

Australia - Belgium - Brazil - Canada - China - Czech Republic - Finland - France - Germany - Hong Kong - India - Israel - Italy - Japan - Malaysia - Malta - Morocco - Singapore - Spain - Sweden - Switzerland - United Kingdom - United States of America
www.st.com