



# T4 Series

SNUBBERLESS™ & LOGIC LEVEL

4A TRIACs

## MAIN FEATURES:

Symbol	Value	Unit
$I_{T(RMS)}$	4	A
$V_{DRM}/V_{RRM}$	600 to 800	V
$I_{GTT} (Q_1)$	5 to 35	mA

## DESCRIPTION

Based on ST's Snubberless / Logic level technology providing high commutation performances, the T4 series is suitable for use on AC inductive loads. They are recommended for applications using universal motors, electrovalves.... such as kitchen aid equipments, power tools, dishwashers,... Available in a fully insulated package, the T4...-...W version complies with UL standards (ref. E81734).

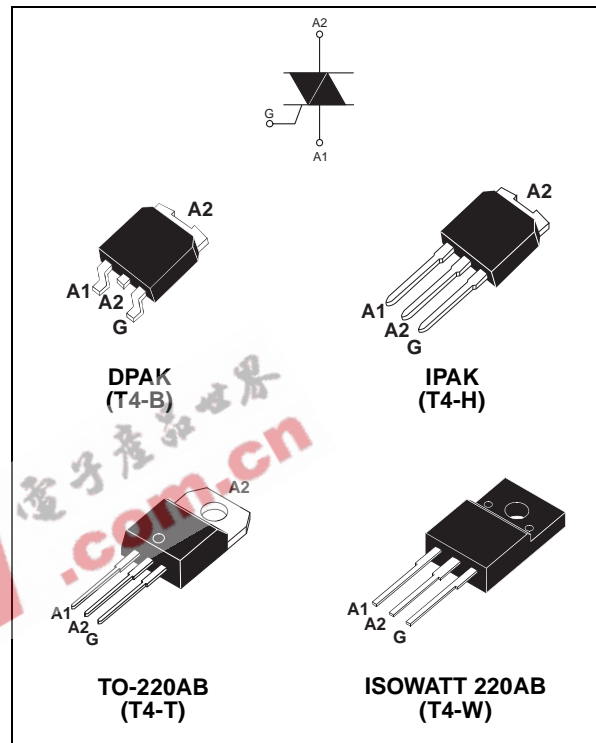

## ABSOLUTE MAXIMUM RATINGS

Symbol	Parameter		Value	Unit	
$I_{T(RMS)}$	RMS on-state current (full sine wave)	DKPAK / IPAK TO-220AB	$T_c = 110^\circ\text{C}$	4	A
		ISOWATT 220AB	$T_c = 105^\circ\text{C}$		
$I_{TSM}$	Non repetitive surge peak on-state current (full cycle, $T_j$ initial = $25^\circ\text{C}$ )	F = 50 Hz	t = 20 ms	30	A
		F = 60 Hz	t = 16.7 ms	31	
$I^2t$	$I^2t$ Value for fusing	tp = 10 ms		5.1	$\text{A}^2\text{s}$
dl/dt	Critical rate of rise of on-state current $I_G = 2 \times I_{GT}$ , tr ≤ 100 ns	F = 120 Hz	$T_j = 125^\circ\text{C}$	50	$\text{A}/\mu\text{s}$
$I_{GM}$	Peak gate current	tp = 20 μs	$T_j = 125^\circ\text{C}$	4	A
$P_{G(AV)}$	Average gate power dissipation		$T_j = 125^\circ\text{C}$	1	W
$T_{stg}$ $T_j$	Storage junction temperature range Operating junction temperature range			- 40 to + 150 - 40 to + 125	$^\circ\text{C}$

## T4 Series

### ELECTRICAL CHARACTERISTICS (T<sub>j</sub> = 25°C, unless otherwise specified)

Symbol	Test Conditions	Quadrant		T4			Unit
				T405	T410	T435	
I <sub>GT</sub> (1)	V <sub>D</sub> = 12 V    R <sub>L</sub> = 30 Ω	I - II - III	MAX.	5	10	35	mA
V <sub>GT</sub>		I - II - III	MAX.	1.3			V
V <sub>GD</sub>	V <sub>D</sub> = V <sub>DRM</sub> R <sub>L</sub> = 33 kΩ T <sub>j</sub> = 125°C	I - II - III	MIN.	0.2			V
I <sub>H</sub> (2)	I <sub>T</sub> = 100 mA		MAX.	10	15	35	mA
I <sub>L</sub>	I <sub>G</sub> = 1.2 I <sub>GT</sub>	I - III	MAX.	10	25	50	mA
		II		15	30	60	
dV/dt (2)	V <sub>D</sub> = 67 %V <sub>DRM</sub> gate open    T <sub>j</sub> = 125°C		MIN.	20	40	400	V/μs
(di/dt) <sub>c</sub> (2)	(dV/dt) <sub>c</sub> = 0.1 V/μs    T <sub>j</sub> = 125°C		MIN.	1.8	2.7	-	A/ms
	(dV/dt) <sub>c</sub> = 10 V/μs    T <sub>j</sub> = 125°C			0.9	2.0	-	
	Without snubber    T <sub>j</sub> = 125°C			-	-	2.5	

### STATIC CHARACTERISTICS

Symbol	Test Conditions		Value	Unit	
V <sub>TM</sub> (2)	I <sub>TM</sub> = 5.5 A	tp = 380 μs	T <sub>j</sub> = 25°C    MAX.	1.6	V
V <sub>to</sub> (2)	Threshold voltage		T <sub>j</sub> = 125°C    MAX.	0.9	V
R <sub>d</sub> (2)	Dynamic resistance		T <sub>j</sub> = 125°C    MAX.	120	mΩ
I <sub>DRM</sub> I <sub>RDM</sub>	V <sub>DRM</sub> = V <sub>RDM</sub>		T <sub>j</sub> = 25°C    MAX.	5	μA
			T <sub>j</sub> = 125°C	1	mA

**Note 1:** minimum IGT is guaranteed at 5% of IGT max.

**Note 2:** for both polarities of A2 referenced to A1

### THERMAL RESISTANCES

Symbol	Parameter		Value	Unit	
R <sub>th(j-c)</sub>	Junction to case (AC)		DPAK IPAK TO-220AB	2.6	°C/W
			ISOWATT220AB	4.0	
R <sub>th(j-a)</sub>	Junction to ambient	S = 0.5 cm <sup>2</sup>	DPAK	70	°C/W
			TO-220AB ISOWATT220AB	60	
			IPAK	100	

S = Copper surface under tab

PRODUCT SELECTOR

Part Number	Voltage (xxx)			Sensitivity	Type	Package
	600 V	700 V	800 V			
T405-xxxB	X	X	X	5 mA	Logic level	DPAK
T405-xxxH	X	X	X	5 mA	Logic level	IPAK
T405-xxxT	X	X	X	5 mA	Logic level	TO-220AB
T405-xxxW	X	X	X	5 mA	Logic level	ISOWATT220AB
T410-xxxB	X	X	X	10 mA	Logic level	DPAK
T410-xxxH	X	X	X	10 mA	Logic level	IPAK
T410-xxxT	X	X	X	10 mA	Logic level	TO-220AB
T410-xxxW	X	X	X	10 mA	Logic level	ISOWATT220AB
T435-xxxB	X	X	X	35 mA	Snubberless	DPAK
T435-xxxH	X	X	X	35 mA	Snubberless	IPAK
T435-xxxT	X	X	X	35 mA	Snubberless	TO-220AB
T435-xxxW	X	X	X	35 mA	Snubberless	ISOWATT220AB

ORDERING INFORMATION

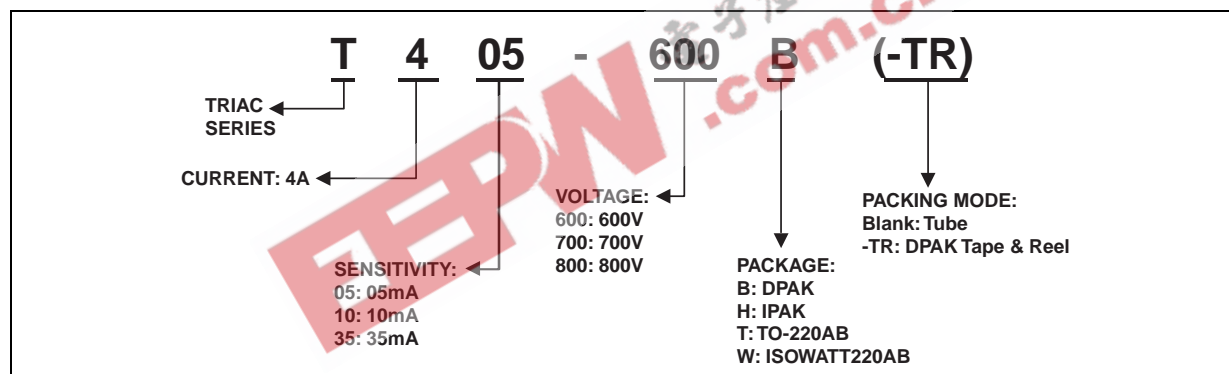

OTHER INFORMATION

Part Number	Marking	Weight	Base quantity	Packing mode
T4xx-yyyB	T4xyyyyB	0.3 g	75	Tube
T4xx-yyyB-TR	T4xyyyyB	0.3 g	2500	Tape & reel
T4xx-yyyH	T4xyyyy	0.4 g	75	Tube
T4xx-yyyT	T4xyyyyT	2.3 g	50	Tube
T4xx-yyyW	T4xyyyyW	2.1 g	50	Tube

Note: xx = sensitivity, yyy = voltage

**Fig. 1:** Maximum power dissipation versus RMS on-state current (full cycle).

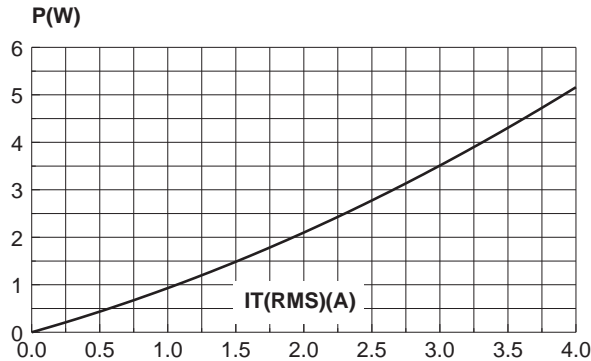

**Fig. 2-1:** RMS on-state current case versus temperature (full cycle).

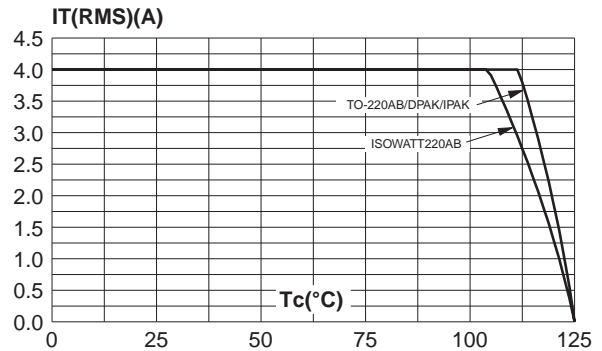

**Fig. 2-2:** RMS on-state current versus ambient temperature (printed circuit FR4, copper thickness: 35µm), full cycle.

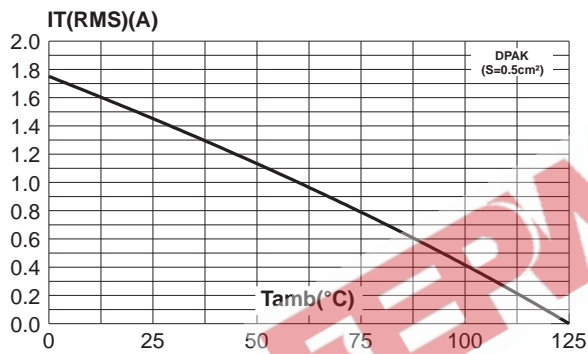

**Fig. 3:** Relative variation of thermal impedance versus pulse duration.

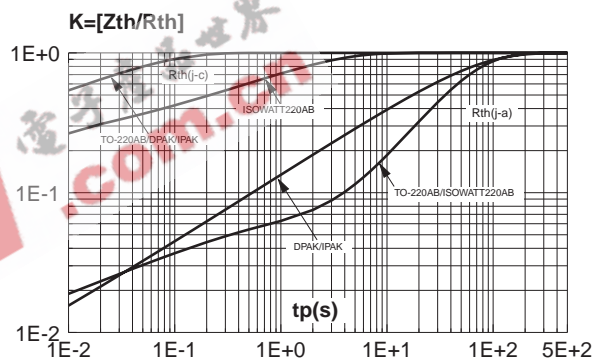

**Fig. 4:** Relative variation of gate trigger current, holding current and latching current versus junction temperature (typical values).

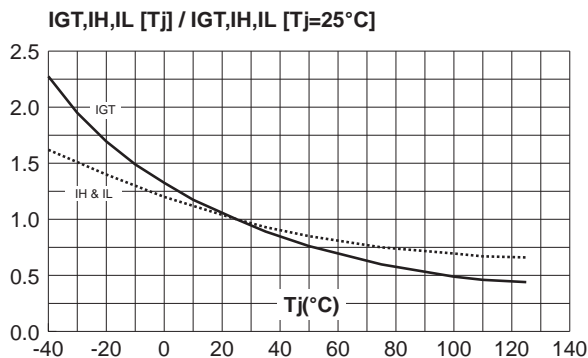

**Fig. 5:** Surge peak on-state current versus number of cycles.

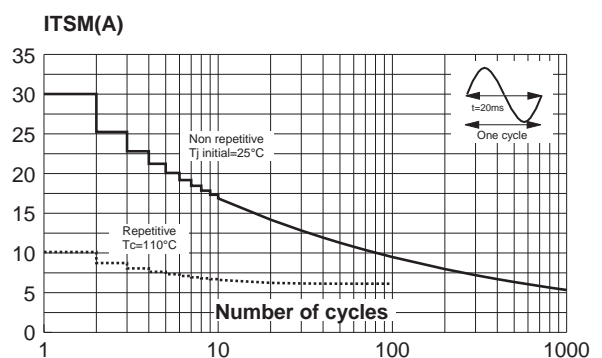

**Fig. 6:** Non-repetitive surge peak on-state current for a sinusoidal pulse with width  $t_p < 10\text{ms}$ , and corresponding value of  $I^2t$ .

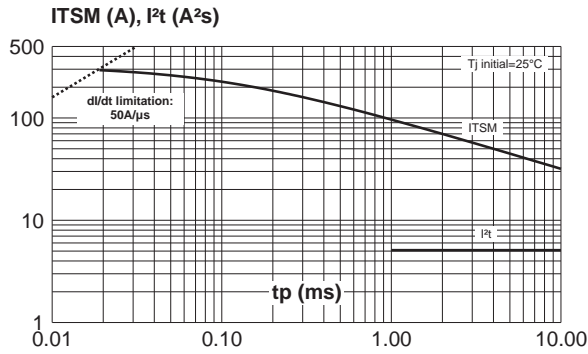

**Fig. 7:** On-state characteristics (maximum values).

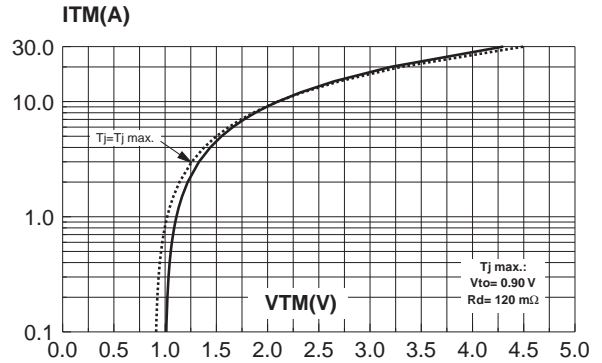

**Fig. 8:** Relative variation of critical rate of decrease of main current versus  $(dV/dt)_c$  (typical values).

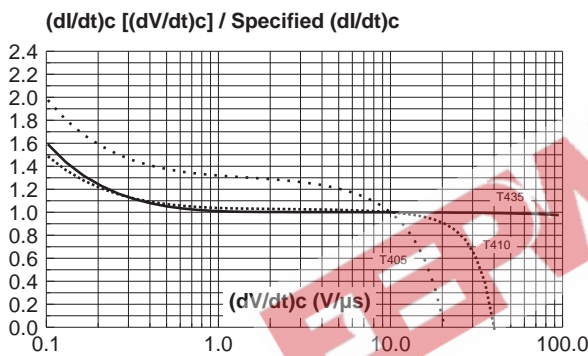

**Fig. 9:** Relative variation of critical rate of decrease of main current versus junction temperature.

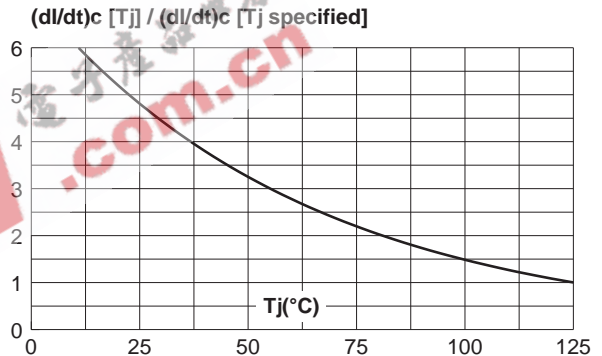

**Fig. 10:** DPAK thermal resistance junction to ambient versus copper surface under tab (printed circuit board FR4, copper thickness: 35 $\mu$ m).

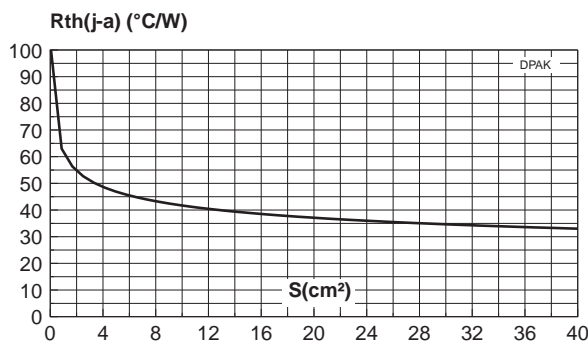

## T4 Series

### PACKAGE MECHANICAL DATA

DPAK (Plastic)

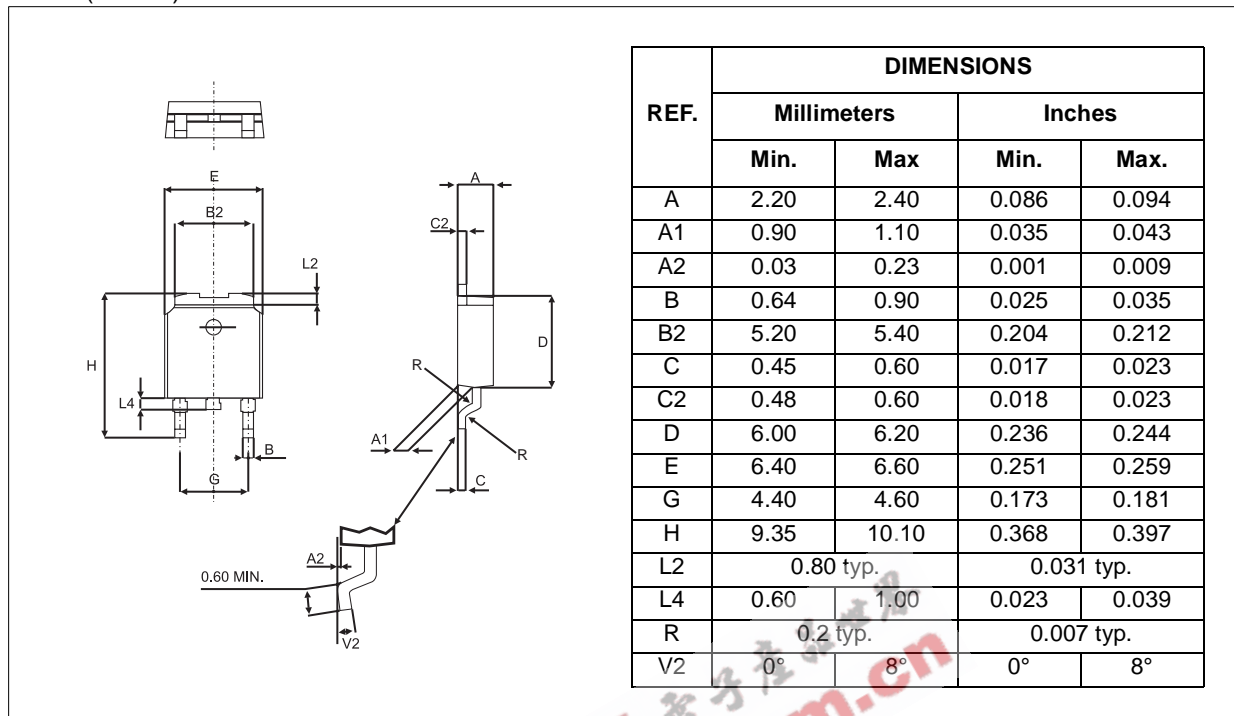

### FOOTPRINT DIMENSIONS (in millimeters)

DPAK (Plastic)

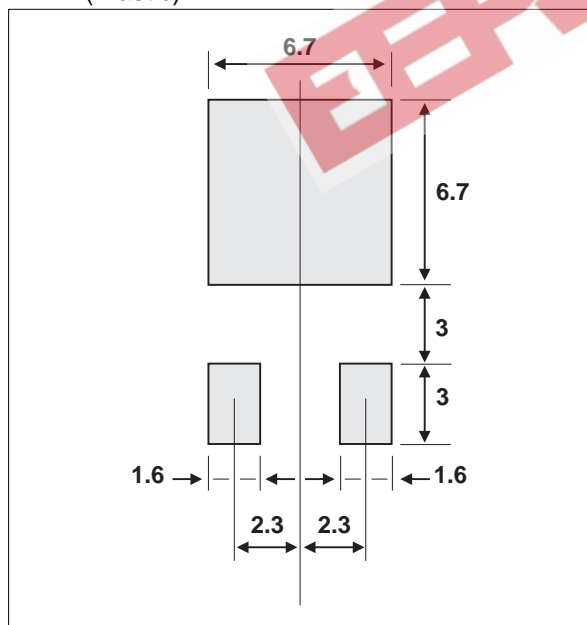

**PACKAGE MECHANICAL DATA**

ISOWATT220AB (Plastic)

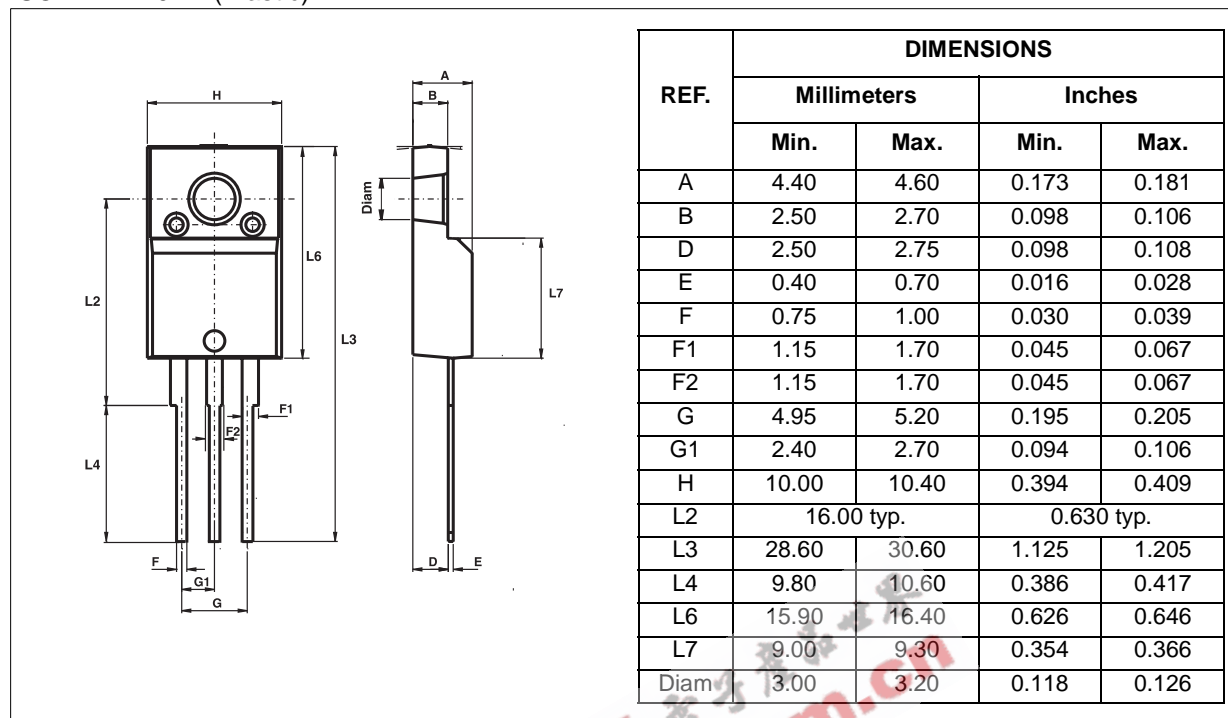

**PACKAGE MECHANICAL DATA**

TO-220AB (Plastic)

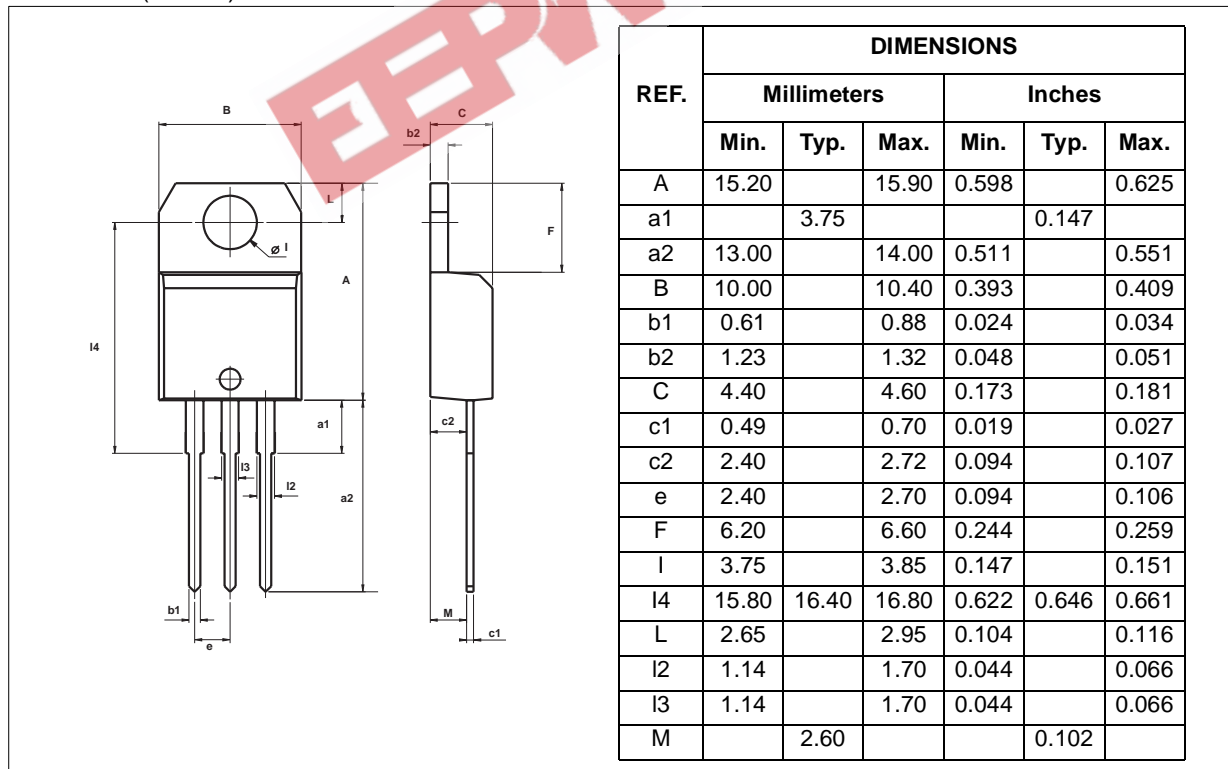

## T4 Series

### PACKAGE MECHANICAL DATA

#### IPAK (Plastic)

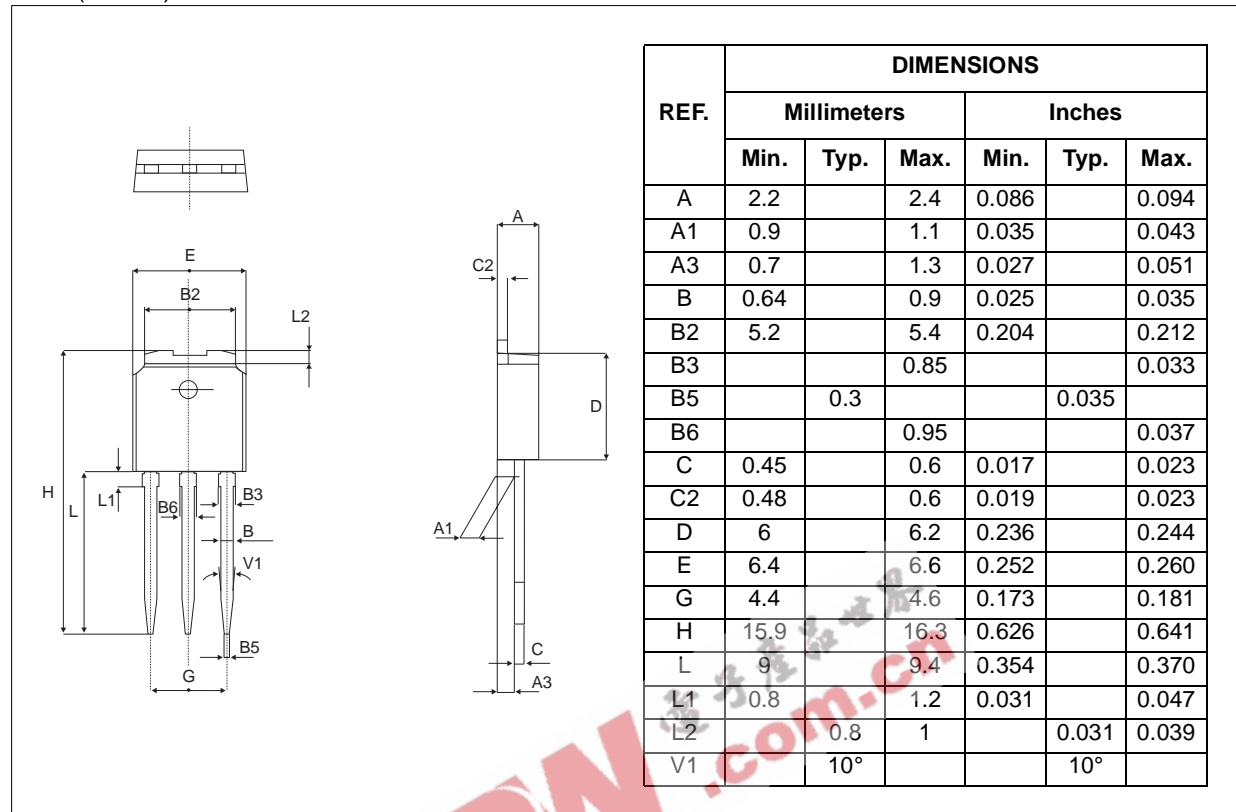

Information furnished is believed to be accurate and reliable. However, STMicroelectronics assumes no responsibility for the consequences of use of such information nor for any infringement of patents or other rights of third parties which may result from its use. No license is granted by implication or otherwise under any patent or patent rights of STMicroelectronics. Specifications mentioned in this publication are subject to change without notice. This publication supersedes and replaces all information previously supplied. STMicroelectronics products are not authorized for use as critical components in life support devices or systems without express written approval of STMicroelectronics.

© The ST logo is a registered trademark of STMicroelectronics

© 2003 STMicroelectronics - Printed in Italy - All Rights Reserved

STMicroelectronics GROUP OF COMPANIES

Australia - Brazil - China - Finland - France - Germany - Hong Kong - India - Italy - Japan - Malaysia  
Malta - Morocco - Singapore - Spain - Sweden - Switzerland - United Kingdom - U.S.A

<http://www.st.com>