



TC1054/TC1055/TC1186

50 mA, 100 mA and 150 mA CMOS LDOs with Shutdown and ERROR Output

Features

- Low Ground Current for Longer Battery Life
- Low Dropout Voltage
- Choice of 50 mA (TC1054), 100 mA (TC1055) and 150 mA (TC1186) Output
- High Output Voltage Accuracy
- Standard or Custom Output Voltages:
 - 1.8V, 2.5V, 2.6V, 2.7V, 2.8V, 2.85V, 3.0V, 3.3V, 3.6V, 4.0V, 5.0V
- Power-Saving Shutdown Mode
- ERROR Output Can Be Used as a Low Battery Detector or Microcontroller Reset Generator
- Overcurrent and Overtemperature Protection
- 5-Pin SOT-23 Package
- Pin Compatible Upgrades for Bipolar Regulators

Applications

- Battery Operated Systems
- Portable Computers
- Medical Instruments
- Instrumentation
- Cellular/GSM/PHS Phones
- Linear Post-Regulators for SMPS
- Pagers

Typical Application

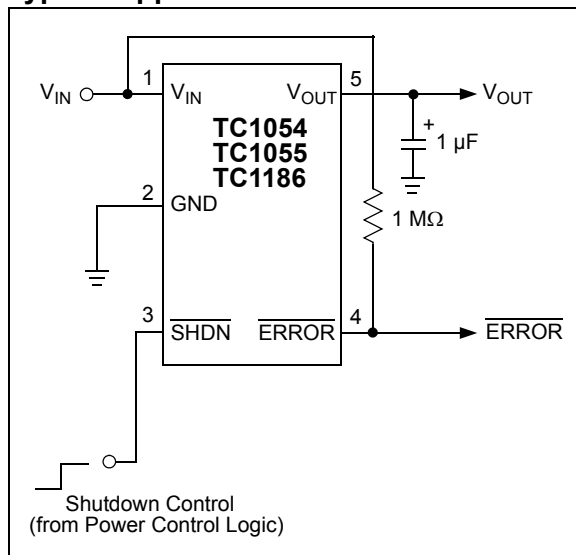

General Description

The TC1054, TC1055 and TC1186 are high accuracy (typically $\pm 0.5\%$) CMOS upgrades for older (bipolar) low dropout regulators. Designed specifically for battery-operated systems, the devices' CMOS construction minimizes ground current, extending battery life. Total supply current is typically 50 μA at full load (20 to 60 times lower than in bipolar regulators).

The devices' key features include low noise operation, low dropout voltage – typically 85 mV (TC1054), 180 mV (TC1055) and 270 mV (TC1186) at full load — and fast response to step changes in load. An error output (ERROR) is asserted when the devices are out-of-regulation (due to a low input voltage or excessive output current). ERROR can be used as a low battery warning or as a processor RESET signal (with the addition of an external RC network). Supply current is reduced to 0.5 μA (max), with both V_{OUT} and ERROR disabled when the shutdown input is low. The devices incorporate both over-temperature and over-current protection.

The TC1054, TC1055 and TC1186 are stable with an output capacitor of only 1 μF and have a maximum output current of 50 mA, 100 mA and 150 mA, respectively. For higher output current regulators, please refer to the TC1173 ($I_{\text{OUT}} = 300 \text{ mA}$) data sheet (DS21632).

Package Type

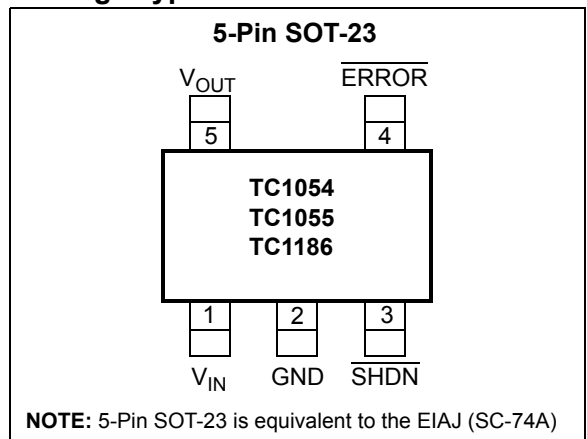

TC1054/TC1055/TC1186

1.0 ELECTRICAL CHARACTERISTICS

Absolute Maximum Ratings †

Input Voltage	6.5V
Output Voltage	(-0.3V) to (V _{IN} + 0.3V)
Power Dissipation	Internally Limited (Note 6)
Maximum Voltage on Any Pin	V _{IN} + 0.3V to -0.3V
Operating Junction Temperature Range ..	-40°C < T _J < 125°C
Storage Temperature.....	-65°C to +150°C

† Stresses above those listed under "Absolute Maximum Ratings" may cause permanent damage to the device. These are stress ratings only and functional operation of the device at these or any other conditions above those indicated in the operation sections of the specifications is not implied. Exposure to Absolute Maximum Rating conditions for extended periods may affect device reliability.

DC CHARACTERISTICS

Electrical Specifications: Unless otherwise noted, V _{IN} = V _{OUT} + 1V, I _L = 100 μA, C _L = 3.3 μF, SHDN > V _{IH} , T _A = +25°C. Boldface type specifications apply for junction temperatures of -40°C to +125°C.						
Parameters	Sym	Min	Typ	Max	Units	Conditions
Input Operating Voltage	V _{IN}	2.7	—	6.0	V	Note 8
Maximum Output Current	I _{OUTMAX}	50 100 150	— — —	— — —	mA	TC1054 TC1055 TC1186
Output Voltage	V _{OUT}	V_R - 2.5%	V _R ± 0.5%	V_R + 2.5%	V	Note 1
V _{OUT} Temperature Coefficient	TCV _{OUT}	— —	20 40	— —	ppm/°C	Note 2
Line Regulation	ΔV _{OUT} /ΔV _{IN}	—	0.05	0.35	%	(V _R + 1V) ≤ V _{IN} ≤ 6V
Load Regulation: TC1054; TC1055 TC1186	ΔV _{OUT} /V _{OUT}	— —	0.5 0.5	2 3	%	(Note 3) I _L = 0.1 mA to I _{OUTMAX} I _L = 0.1 mA to I _{OUTMAX}
Dropout Voltage: TC1055; TC1186 TC1186	V _{IN} -V _{OUT}	— — — — —	2 65 85 180 270	— — 120 250 400	mV	I _L = 100 μA I _L = 20 mA I _L = 50 mA I _L = 100 mA I _L = 150 mA (Note 4)
Supply Current	I _{IN}	—	50	80	μA	SHDN = V _{IH} , I _L = 0 μA (Note 9)
Shutdown Supply Current	I _{INSD}	—	0.05	0.5	μA	SHDN = 0V
Power Supply Rejection Ratio	PSRR	—	64	—	dB	f ≤ 1 kHz
Output Short Circuit Current	I _{OUTSC}	—	300	450	mA	V _{OUT} = 0V
Thermal Regulation	ΔV _{OUT} /ΔP _D	—	0.04	—	V/W	Notes 5, 6
Thermal Shutdown Die Temperature	T _{SD}	—	160	—	°C	
Thermal Shutdown Hysteresis	ΔT _{SD}	—	10	—	°C	

Note 1: V_R is the regulator output voltage setting. For example: V_R = 1.8V, 2.5V, 2.7V, 2.85V, 3.0V, 3.3V, 3.6V, 4.0V, 5.0V.

Note 2: $TC V_{OUT} = \frac{(V_{OUTMAX} - V_{OUTMIN}) \times 10^6}{V_{OUT} \times \Delta T}$

- 3:** Regulation is measured at a constant junction temperature using low duty cycle pulse testing. Load regulation is tested over a load range from 0.1 mA to the maximum specified output current. Changes in output voltage due to heating effects are covered by the thermal regulation specification.
- 4:** Dropout voltage is defined as the input to output differential at which the output voltage drops 2% below its nominal value.
- 5:** Thermal Regulation is defined as the change in output voltage at a time T after a change in power dissipation is applied, excluding load or line regulation effects. Specifications are for a current pulse equal to I_{LMAX} at V_{IN} = 6V for T = 10 ms.
- 6:** The maximum allowable power dissipation is a function of ambient temperature, the maximum allowable junction temperature and the thermal resistance from junction-to-air (i.e., T_A, T_J, θ_{JA}). Exceeding the maximum allowable power dissipation causes the device to initiate thermal shutdown. Please see **Section 5.0 "Thermal Considerations"**, "Thermal Considerations", for more details.
- 7:** Hysteresis voltage is referenced by V_R.
- 8:** The minimum V_{IN} has to justify the conditions: V_{IN} ≥ V_R + V_{DROPOUT} and V_{IN} ≥ 2.7V for I_L = 0.1 mA to I_{OUTMAX}.
- 9:** Apply for junction temperatures of -40C to +85C.

TC1054/TC1055/TC1186

DC CHARACTERISTICS (CONTINUED)

Electrical Specifications: Unless otherwise noted, $V_{IN} = V_{OUT} + 1V$, $I_L = 100 \mu A$, $C_L = 3.3 \mu F$, $\overline{SHDN} > V_{IH}$, $T_A = +25^\circ C$. Boldface type specifications apply for junction temperatures of $-40^\circ C$ to $+125^\circ C$.						
Parameters	Sym	Min	Typ	Max	Units	Conditions
Output Noise	eN	—	260	—	nV/ \sqrt{Hz}	$I_L = I_{OUTMAX}$
SHDN Input						
SHDN Input High Threshold	V_{IH}	45	—	—	% V_{IN}	$V_{IN} = 2.5V$ to $6.5V$
SHDN Input Low Threshold	V_{IL}	—	—	15	% V_{IN}	$V_{IN} = 2.5V$ to $6.5V$
ERROR Output						
Minimum V_{IN} Operating Voltage	V_{INMIN}	1.0	—	—	V	
Output Logic Low Voltage	V_{OL}	—	—	400	mV	1 mA Flows to ERROR
ERROR Threshold Voltage	V_{TH}	—	$0.95 \times V_R$	—	V	See Figure 4-2
ERROR Positive Hysteresis	V_{HYS}	—	50	—	mV	Note 7
V_{OUT} to ERROR Delay	t_{DELAY}	—	2.5	—	ms	V_{OUT} falling from V_R to $V_R - 10\%$

Note 1: V_R is the regulator output voltage setting. For example: $V_R = 1.8V, 2.5V, 2.7V, 2.85V, 3.0V, 3.3V, 3.6V, 4.0V, 5.0V$.

Note 2: $TC V_{OUT} = \frac{(V_{OUTMAX} - V_{OUTMIN}) \times 10^6}{V_{OUT} \times \Delta T}$

- 3: Regulation is measured at a constant junction temperature using low duty cycle pulse testing. Load regulation is tested over a load range from 0.1 mA to the maximum specified output current. Changes in output voltage due to heating effects are covered by the thermal regulation specification.
- 4: Dropout voltage is defined as the input to output differential at which the output voltage drops 2% below its nominal value.
- 5: Thermal Regulation is defined as the change in output voltage at a time T after a change in power dissipation is applied, excluding load or line regulation effects. Specifications are for a current pulse equal to I_{LMAX} at $V_{IN} = 6V$ for $T = 10$ ms.
- 6: The maximum allowable power dissipation is a function of ambient temperature, the maximum allowable junction temperature and the thermal resistance from junction-to-air (i.e., T_A, T_J, θ_{JA}). Exceeding the maximum allowable power dissipation causes the device to initiate thermal shutdown. Please see **Section 5.0 "Thermal Considerations"**, "Thermal Considerations", for more details.
- 7: Hysteresis voltage is referenced by V_R .
- 8: The minimum V_{IN} has to justify the conditions: $V_{IN} \geq V_R + V_{DROPOUT}$ and $V_{IN} \geq 2.7V$ for $I_L = 0.1$ mA to I_{OUTMAX} .
- 9: Apply for junction temperatures of $-40C$ to $+85C$.

TC1054/TC1055/TC1186

2.0 TYPICAL PERFORMANCE CURVES

Note: The graphs and tables provided following this note are a statistical summary based on a limited number of samples and are provided for informational purposes only. The performance characteristics listed herein are not tested or guaranteed. In some graphs or tables, the data presented may be outside the specified operating range (e.g., outside specified power supply range) and therefore outside the warranted range.

Note: Unless otherwise indicated, $V_{IN} = V_{OUT} + 1V$, $I_L = 100 \mu A$, $C_L = 3.3 \mu F$, $\overline{SHDN} > V_{IH}$, $T_A = +25^\circ C$.

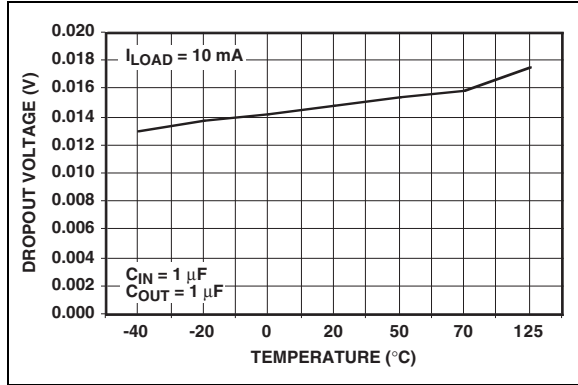

FIGURE 2-1: Dropout Voltage vs. Temperature ($I_{LOAD} = 10 \text{ mA}$).

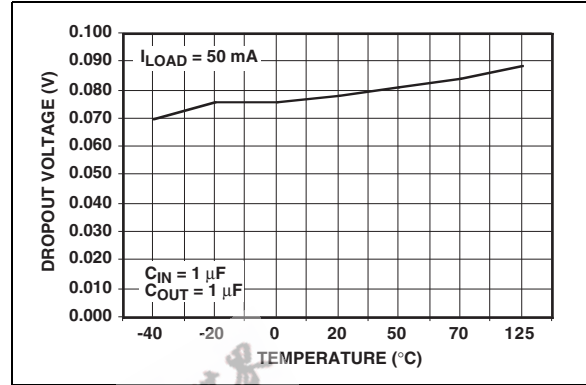

FIGURE 2-4: Dropout Voltage vs. Temperature ($I_{LOAD} = 50 \text{ mA}$).

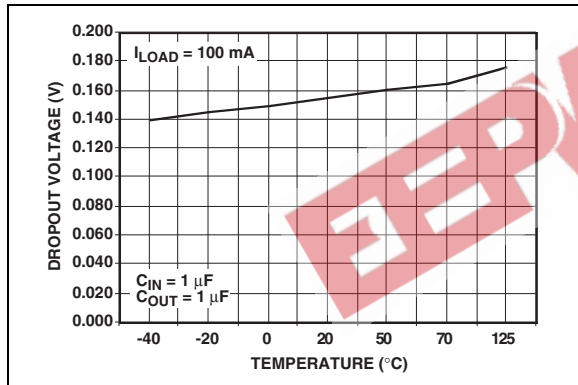

FIGURE 2-2: Dropout Voltage vs. Temperature ($I_{LOAD} = 100 \text{ mA}$).

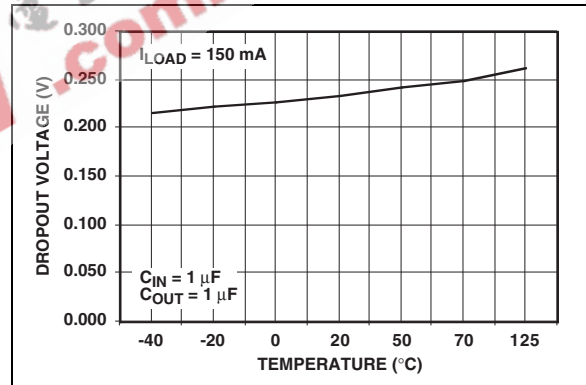

FIGURE 2-5: Dropout Voltage vs. Temperature ($I_{LOAD} = 150 \text{ mA}$).

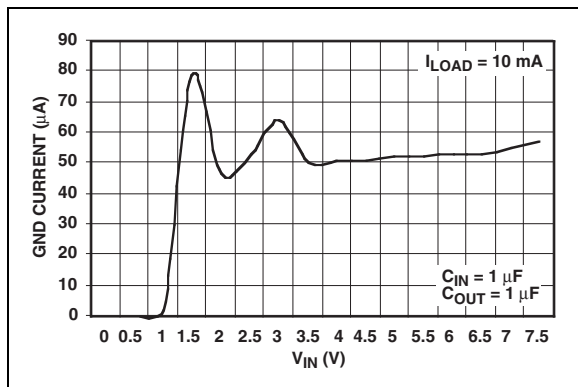

FIGURE 2-3: Ground Current vs. V_{IN} ($I_{LOAD} = 10 \text{ mA}$).

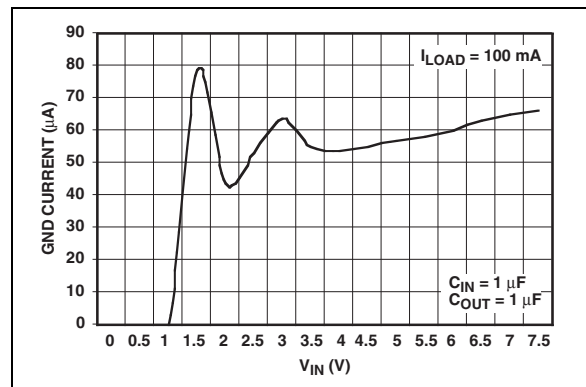

FIGURE 2-6: Ground Current vs. V_{IN} ($I_{LOAD} = 100 \text{ mA}$).

TC1054/TC1055/TC1186

Note: Unless otherwise indicated, $V_{IN} = V_{OUT} + 1V$, $I_L = 100 \mu A$, $C_L = 3.3 \mu F$, $\overline{SHDN} > V_{IH}$, $T_A = +25^\circ C$.

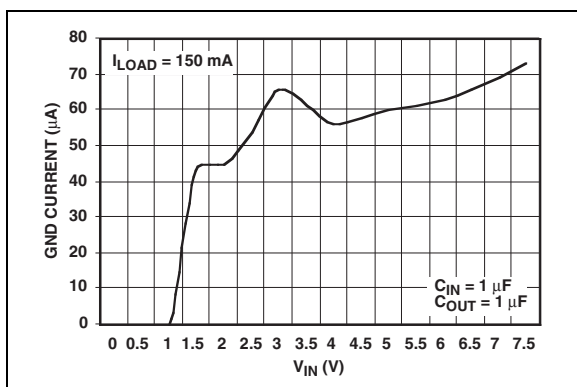

FIGURE 2-7: Ground Current vs. V_{IN} ($I_{LOAD} = 150 \text{ mA}$).

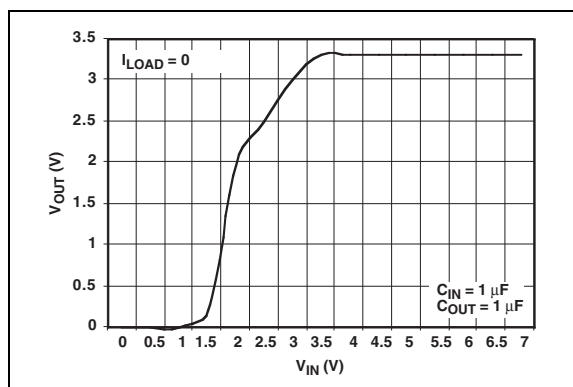

FIGURE 2-10: V_{OUT} vs. V_{IN} ($I_{LOAD} = 0 \text{ mA}$).

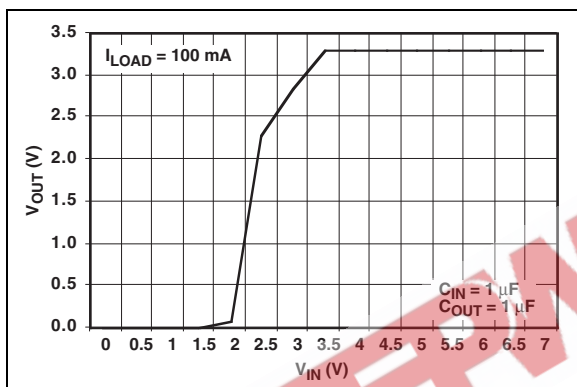

FIGURE 2-8: V_{OUT} vs. V_{IN} ($I_{LOAD} = 100 \text{ mA}$).

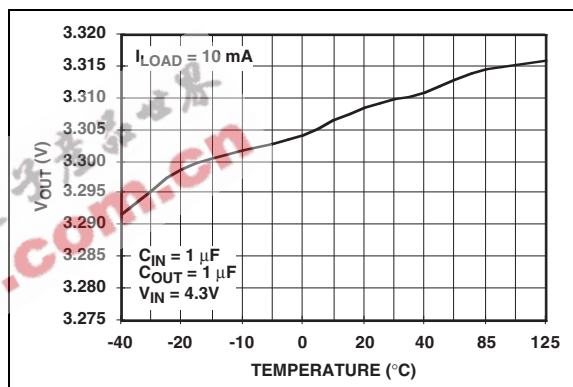

FIGURE 2-11: Output Voltage (3.3V) vs. Temperature ($I_{LOAD} = 10 \text{ mA}$).

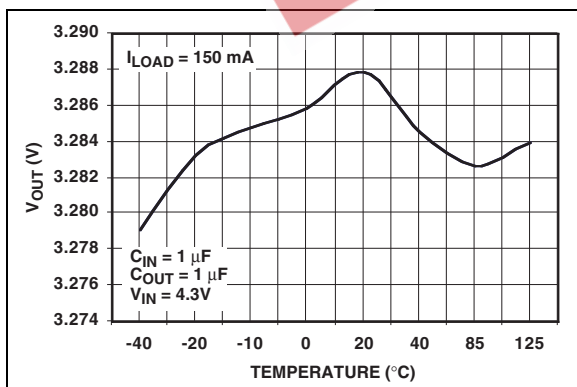

FIGURE 2-9: V_{OUT} vs. V_{IN} ($I_{LOAD} = 150 \text{ mA}$).

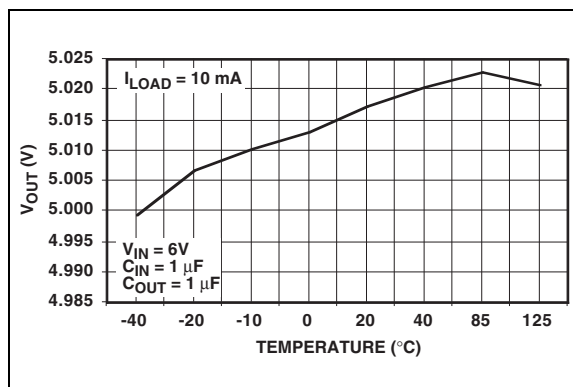

FIGURE 2-12: Output Voltage (5V) vs. Temperature ($I_{LOAD} = 10 \text{ mA}$).

TC1054/TC1055/TC1186

Note: Unless otherwise indicated, $V_{IN} = V_{OUT} + 1V$, $I_L = 100 \mu A$, $C_L = 3.3 \mu F$, $\overline{SHDN} > V_{IH}$, $T_A = +25^\circ C$.

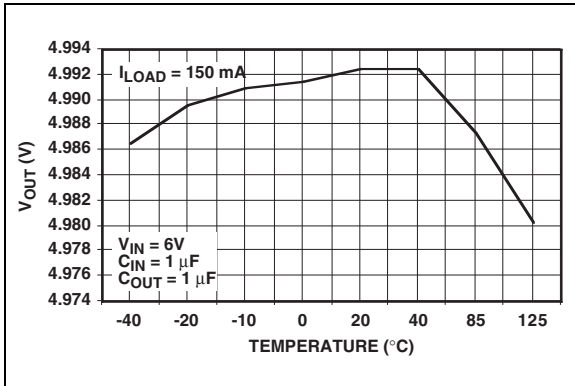

FIGURE 2-13: Output Voltage (5V) vs. Temperature ($I_{LOAD} = 10 \text{ mA}$).

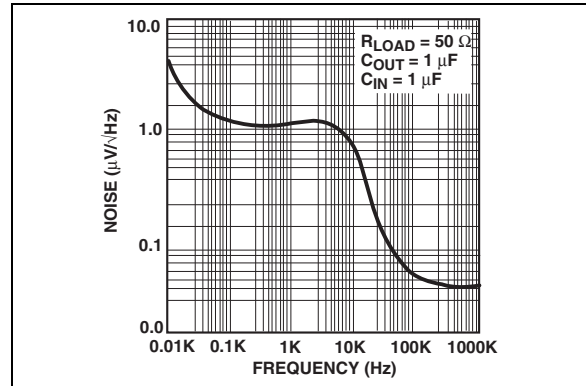

FIGURE 2-16: Output Noise vs. Frequency.

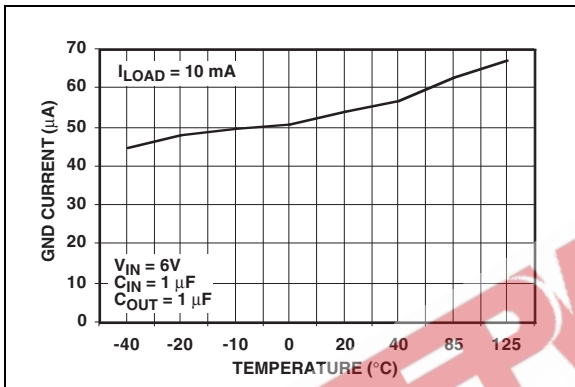

FIGURE 2-14: GND Current vs. Temperature ($I_{LOAD} = 10 \text{ mA}$).

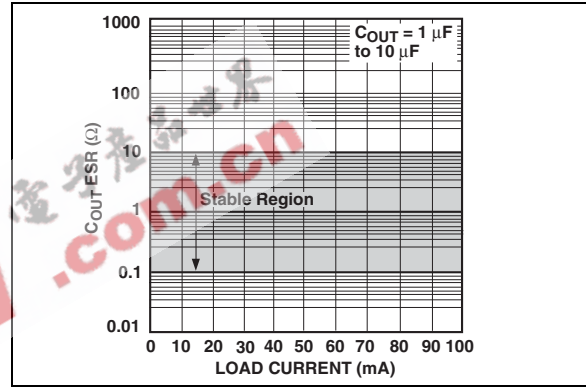

FIGURE 2-17: Stability Region vs. Load Current.

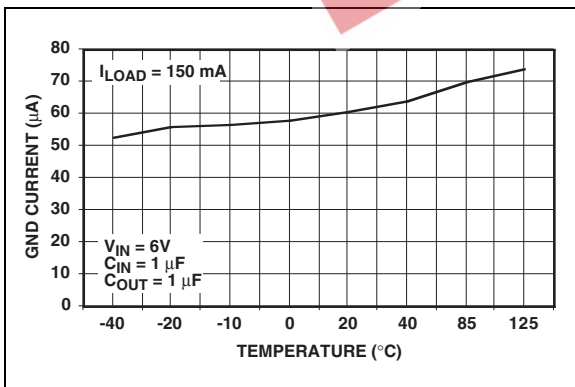

FIGURE 2-15: GND Current vs. Temperature ($I_{LOAD} = 150 \text{ mA}$).

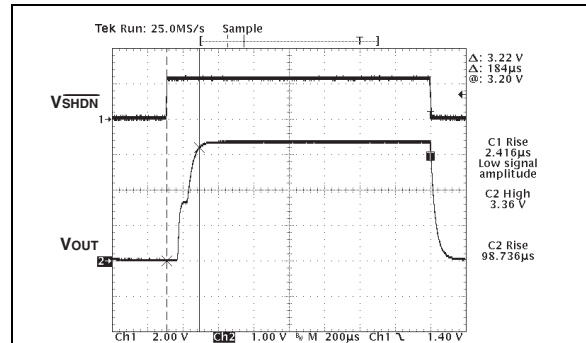

FIGURE 2-18: Measure Rise Time of 3.3V LDO.

TC1054/TC1055/TC1186

Note: Unless otherwise indicated, $V_{IN} = V_{OUT} + 1V$, $I_L = 100 \mu A$, $C_L = 3.3 \mu F$, $\overline{SHDN} > V_{IH}$, $T_A = +25^\circ C$.

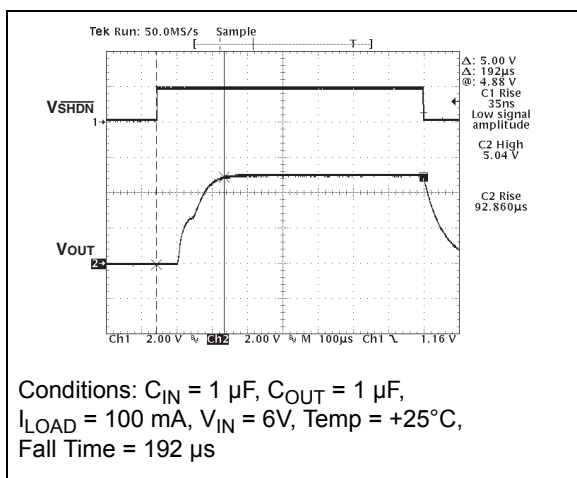

FIGURE 2-19: Measure Rise Time of 5.0V LDO.

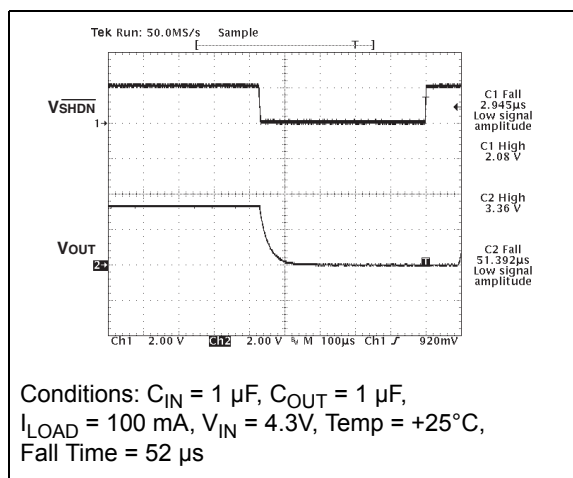

FIGURE 2-21: Measure Fall Time of 3.3V LDO.

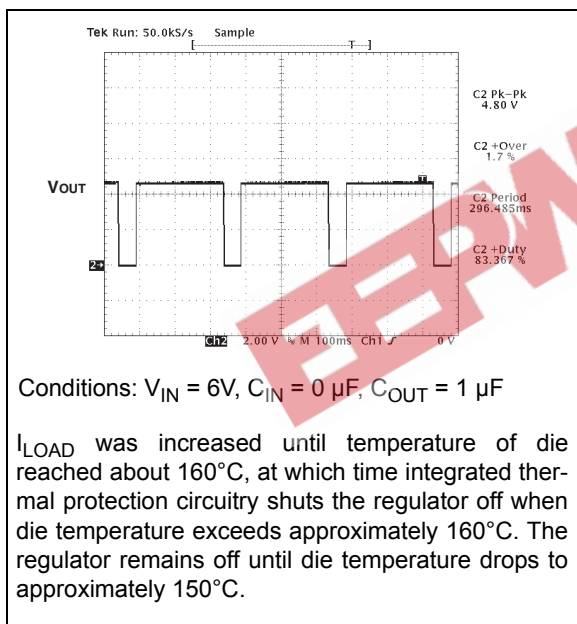

FIGURE 2-20: Thermal Shutdown Response of 5.0V LDO.

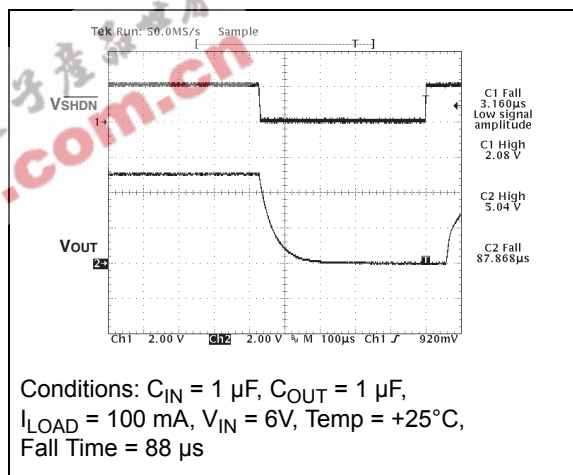

FIGURE 2-22: Measure Fall Time of 5.0V LDO.

TC1054/TC1055/TC1186

3.0 PIN DESCRIPTIONS

The descriptions of the pins are listed in [Table 3-1](#).

TABLE 3-1: PIN FUNCTION TABLE

Pin No.	Symbol	Description
1	V_{IN}	Unregulated supply input
2	GND	Ground terminal
3	$\overline{\text{SHDN}}$	Shutdown control input
4	$\overline{\text{ERROR}}$	Out-of-Regulation Flag (Open-drain output)
5	V_{OUT}	Regulated voltage output

3.1 Unregulated Supply Input (V_{IN})

Connect unregulated input supply to the V_{IN} pin. If there is a large distance between the input supply and the LDO regulator, some input capacitance is necessary for proper operation. A 1 μF capacitor connected from V_{IN} to ground is recommended for most applications.

3.2 Ground Terminal (GND)

Connect the unregulated input supply ground return to GND. Also connect the negative side of the 1 μF typical input decoupling capacitor close to GND and the negative side of the output capacitor C_{OUT} to GND.

3.3 Shutdown Control Input ($\overline{\text{SHDN}}$)

The regulator is fully enabled when a logic-high is applied to $\overline{\text{SHDN}}$. The regulator enters shutdown when a logic-low is applied to $\overline{\text{SHDN}}$. During shutdown, output voltage falls to zero, $\overline{\text{ERROR}}$ is open-circuited and supply current is reduced to 0.5 μA (max).

3.4 Out Of Regulation Flag ($\overline{\text{ERROR}}$)

$\overline{\text{ERROR}}$ goes low when V_{OUT} is out-of-tolerance by approximately -5%.

3.5 Regulated Voltage Output (V_{OUT})

Connect the output load to V_{OUT} of the LDO. Also connect the positive side of the LDO output capacitor as close as possible to the V_{OUT} pin.

TC1054/TC1055/TC1186

4.0 DETAILED DESCRIPTION

The TC1054, TC1055 and TC1186 are precision fixed output voltage regulators (If an adjustable version is desired, please see the TC1070/TC1071/TC1187 data sheet (DS21353)). Unlike bipolar regulators, the TC1054, TC1055 and TC1186 supply current does not increase with load current.

Figure 4-1 shows a typical application circuit, where the regulator is enabled any time the shutdown input ($\overline{\text{SHDN}}$) is at or above V_{IH} , and shutdown (disabled) when $\overline{\text{SHDN}}$ is at or below V_{IL} . $\overline{\text{SHDN}}$ may be controlled by a CMOS logic gate or I/O port of a microcontroller. If the SHDN input is not required, it should be connected directly to the input supply. While in shutdown, supply current decreases to 0.05 μA (typical), V_{OUT} falls to zero volts, and $\overline{\text{ERROR}}$ is open-circuited.

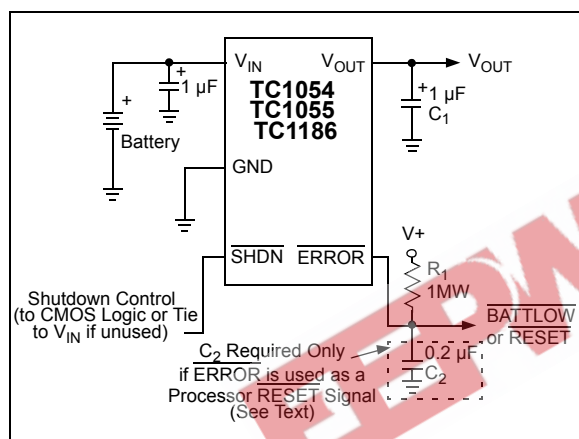

FIGURE 4-1: Typical Application Circuit.

4.1 $\overline{\text{ERROR}}$ Open-Drain Output

$\overline{\text{ERROR}}$ is driven low whenever V_{OUT} falls out of regulation by more than -5% (typical). This condition may be caused by low input voltage, output current limiting or thermal limiting. The $\overline{\text{ERROR}}$ threshold is 5% below rated V_{OUT} , regardless of the programmed output voltage value (e.g. $\overline{\text{ERROR}} = V_{OL}$ at 4.75V (typ.) for a 5.0V regulator and 2.85V (typ.) for a 3.0V regulator). $\overline{\text{ERROR}}$ output operation is shown in Figure 4-2.

Note that $\overline{\text{ERROR}}$ is active when V_{OUT} falls to V_{TH} and inactive when V_{OUT} rises above V_{TH} by V_{HYS} .

As shown in Figure 4-1, $\overline{\text{ERROR}}$ can be used either as a battery low flag or as a processor $\overline{\text{RESET}}$ signal (with the addition of timing capacitor C_2). $R_1 \times C_2$ should be chosen to maintain $\overline{\text{ERROR}}$ below V_{IH} of the processor $\overline{\text{RESET}}$ input for at least 200 ms to allow time for the system to stabilize. Pull-up resistor R_1 can be tied to V_{OUT} , V_{IN} or any other voltage less than $(V_{IN} + 0.3V)$.

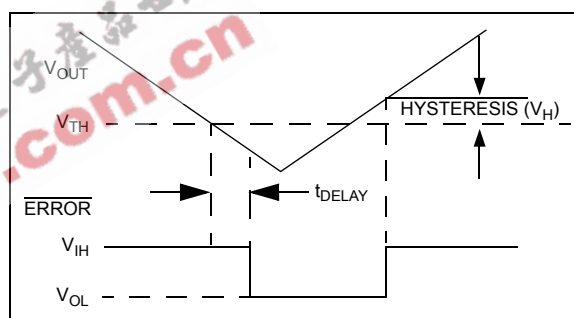

FIGURE 4-2: $\overline{\text{Error}}$ Output Operation.

4.2 Output Capacitor

A 1 μF (minimum) capacitor from V_{OUT} to ground is recommended. The output capacitor should have an effective series resistance greater than 0.1 Ω and less than 5.0 Ω , with a resonant frequency above 1 MHz. A 1 μF capacitor should be connected from V_{IN} to GND if there is more than 10 inches of wire between the regulator and the AC filter capacitor or if a battery is used as the power source. Aluminum electrolytic or tantalum capacitor types can be used (Since many aluminum electrolytic capacitors freeze at approximately -30°C, solid tantalums are recommended for applications operating below -25°C.). When operating from sources other than batteries, supply-noise rejection and transient response can be improved by increasing the value of the input and output capacitors and employing passive filtering techniques.

TC1054/TC1055/TC1186

5.0 THERMAL CONSIDERATIONS

5.1 Thermal Shutdown

Integrated thermal protection circuitry shuts the regulator off when die temperature exceeds 160°C. The regulator remains off until the die temperature drops to approximately 150°C.

5.2 Power Dissipation

The amount of power the regulator dissipates is primarily a function of input voltage, output voltage and output current. The following equation is used to calculate worst case actual power dissipation:

EQUATION 5-1:

$$P_D \approx (V_{INMAX} - V_{OUTMIN}) I_{LOADMAX}$$

Where:

- P_D = Worst case actual power dissipation
- V_{INMAX} = Maximum voltage on V_{IN}
- V_{OUTMIN} = Minimum regulator output voltage
- $I_{LOADMAX}$ = Maximum output (load) current

The maximum allowable power dissipation (Equation 5-2) is a function of the maximum ambient temperature (T_{AMAX}), the maximum allowable die temperature (T_{JMAX}) and the thermal resistance from junction-to-air (θ_{JA}). The 5-Pin SOT-23 package has a θ_{JA} of approximately 220°C/Watt.

EQUATION 5-2:

$$P_{DMAX} = \frac{(T_{JMAX} - T_{AMAX})}{\theta_{JA}}$$

Where all terms are previously defined.

Equation 5-1 can be used in conjunction with Equation 5-2 to ensure regulator thermal operation is within limits.

For example:

Given:

- $V_{INMAX} = 3.0V + 5\%$
- $V_{OUTMIN} = 2.7V - 2.5\%$
- $I_{LOADMAX} = 40 \text{ mA}$
- $T_{JMAX} = +125^\circ\text{C}$
- $T_{AMAX} = +55^\circ\text{C}$

- Find:
1. Actual power dissipation
 2. Maximum allowable dissipation

Actual power dissipation:

$$\begin{aligned} P_D &\approx (V_{INMAX} - V_{OUTMIN}) I_{LOADMAX} \\ &= [(3.0 \times 1.05) - (2.7 \times 0.975)] 40 \times 10^{-3} \\ &= 20.7 \text{ mW} \end{aligned}$$

Maximum allowable power dissipation:

$$\begin{aligned} P_{DMAX} &= \frac{(T_{JMAX} - T_{AMAX})}{\theta_{JA}} \\ &= \frac{(125 - 55)}{220} \\ &= 318 \text{ mW} \end{aligned}$$

In this example, the TC1054 dissipates a maximum of 20.7 mW; below the allowable limit of 318 mW. In a similar manner, Equation 5-1 and Equation 5-2 can be used to calculate maximum current and/or input voltage limits.

5.3 Layout Considerations

The primary path of heat conduction out of the package is via the package leads. Therefore, layouts having a ground plane, wide traces at the pads and wide power supply bus lines combine to lower θ_{JA} and, therefore, increase the maximum allowable power dissipation limit.

TC1054/TC1055/TC1186

6.0 PACKAGING INFORMATION

6.1 Package Marking Information

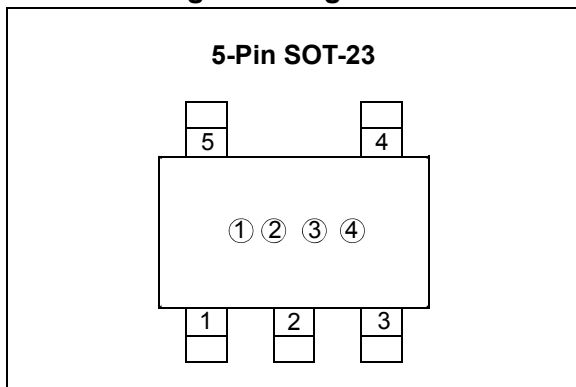

①&② represents part number code + temperature range and voltage

(V)	TC1054 Code	TC1055 Code	TC1186 Code
1.8	CY	DY	PY
2.5	C1	D1	P1
2.6	CT	DT	PV
2.7	C2	D2	P2
2.8	CZ	DZ	PZ
2.85	C8	D8	P8
3.0	C3	D3	P3
3.3	C4	D4	P5
3.6	C9	D9	P9
4.0	C0	D0	P0
5.0	C6	D6	P7

③ represents year and quarter code

④ represents lot ID number

TC1054/TC1055/TC1186

5-Lead Plastic Small Outline Transistor (CT) [SOT-23]

Note: For the most current package drawings, please see the Microchip Packaging Specification located at <http://www.microchip.com/packaging>

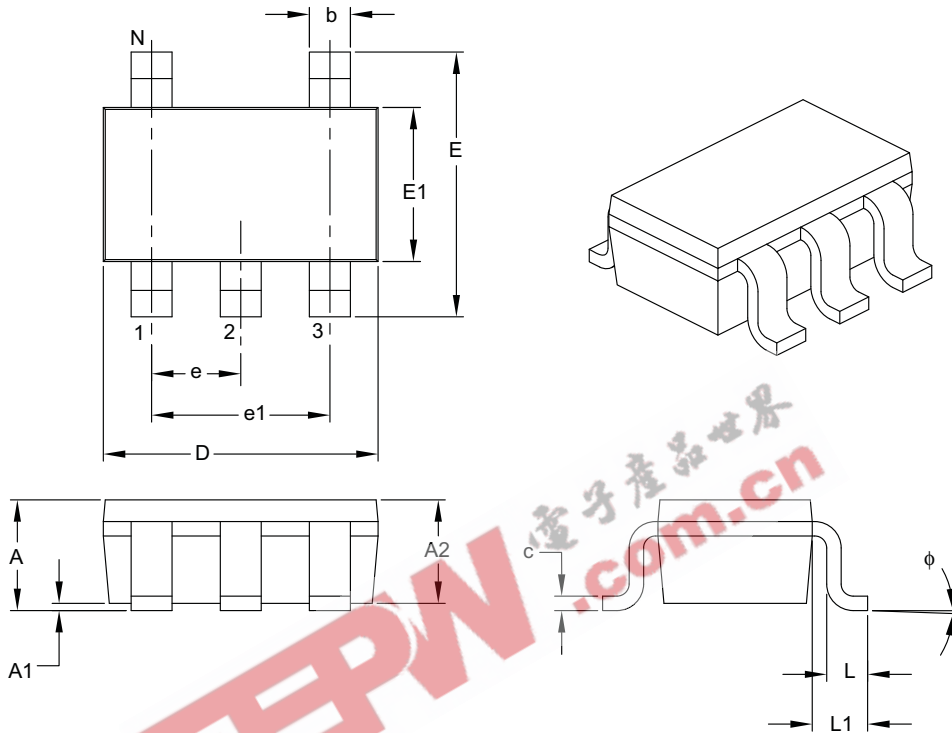

Dimension Limits	Units	MILLIMETERS		
		MIN	NOM	MAX
Number of Pins	N	5		
Lead Pitch	e	0.95 BSC		
Outside Lead Pitch	e1	1.90 BSC		
Overall Height	A	0.90	–	1.45
Molded Package Thickness	A2	0.89	–	1.30
Standoff	A1	0.00	–	0.15
Overall Width	E	2.20	–	3.20
Molded Package Width	E1	1.30	–	1.80
Overall Length	D	2.70	–	3.10
Foot Length	L	0.10	–	0.60
Footprint	L1	0.35	–	0.80
Foot Angle	ϕ	0°	–	30°
Lead Thickness	c	0.08	–	0.26
Lead Width	b	0.20	–	0.51

Notes:

- Dimensions D and E1 do not include mold flash or protrusions. Mold flash or protrusions shall not exceed 0.127 mm per side.
- Dimensioning and tolerancing per ASME Y14.5M.

BSC: Basic Dimension. Theoretically exact value shown without tolerances.

Microchip Technology Drawing C04-091B

APPENDIX A: REVISION HISTORY

Revision D (February 2007)

- Corrected standard output voltages on page 1 and in “**Product Identification System**”.
- Added T_{DELAY} parameter in DC Characteristics table in “**Electrical Characteristics**”.
- Changes to Figure 4-2.
- “**Packaging Information**”: Corrected SOT-23 Packaging Informaton.

Revision C (March 2003)

- Undocumented changes.

Revision B (May 2002)

- Undocumented changes.

Revision A (March 2002)

- Original Release of this Document.

EEPW 电子产品世界
.com.cn

TC1054/TC1055/TC1186

NOTES:

EEPW 电子产品世界
.com.cn

TC1054/TC1055/TC1186

PRODUCT IDENTIFICATION SYSTEM

To order or obtain information, e.g., on pricing or delivery, refer to the factory or the listed sales office.

<u>PART NO.</u>	—	<u>X.X</u>	<u>X</u>	<u>XXXXX</u>	
Device		Output Voltage	Temperature Range	Package	Examples:
Device:		TC1054:	50 mA LDO with Shutdown & <u>Error</u> output		a) TC1054-1.8VCT713: 1.8V LDO Regulator
		TC1055:	100 mA LDO with Shutdown & <u>Error</u> output		b) TC1054-2.5VCT713: 2.5V LDO Regulator
		TC1186:	150 mA LDO with Shutdown & <u>Error</u> output		c) TC1054-2.6VCT713: 2.6V LDO Regulator
Output Voltage *:		1.8 =	1.8V "Standard"		d) TC1054-2.7VCT713: 2.7V LDO Regulator
		2.5 =	2.5V "Standard"		e) TC1054-2.8VCT713: 2.8V LDO Regulator
		2.6 =	2.6V "Standard"		f) TC1054-2.85VCT713: 2.85V LDO Regulator
		2.7 =	2.7V "Standard"		g) TC1054-3.0VCT713: 3.0V LDO Regulator
		2.8 =	2.8V "Standard"		h) TC1054-3.3VCT713: 3.3V LDO Regulator
		2.85 =	2.85V "Standard"		i) TC1054-3.6VCT713: 3.6V LDO Regulator
		3.0 =	3.0V "Standard"		j) TC1054-4.0VCT713: 4.0V LDO Regulator
		3.3 =	3.3V "Standard"		k) TC1054-5.0VCT713: 5.0V LDO Regulator
		3.6 =	3.6V "Standard"		a) TC1055-1.8VCT713: 1.8V LDO Regulator
		4.0 =	4.0V "Standard"		b) TC1055-2.5VCT713: 2.5V LDO Regulator
		5.0 =	5.0V "Standard"		c) TC1055-2.6VCT713: 2.6V LDO Regulator
		*Contact factory for other output voltage options.			d) TC1055-2.7VCT713: 2.7V LDO Regulator
Temperature Range:	V	=	-40°C to +125°C		e) TC1055-2.8VCT713: 2.8V LDO Regulator
Package:		CT713 =	5L SOT-23, Tape and Reel		f) TC1055-2.85VCT713: 2.85V LDO Regulator
					g) TC1055-3.0VCT713: 3.0V LDO Regulator
					h) TC1055-3.3VCT713: 3.3V LDO Regulator
					i) TC1055-3.6VCT713: 3.6V LDO Regulator
					j) TC1055-4.0VCT713: 4.0V LDO Regulator
					k) TC1055-5.0VCT713: 5.0V LDO Regulator
					a) TC1186-1.8VCT713: 1.8V LDO Regulator
					b) TC1186-2.5VCT713: 2.5V LDO Regulator
					c) TC1186-2.6VCT713: 2.6V LDO Regulator
					d) TC1186-2.7VCT713: 2.7V LDO Regulator
					e) TC1186-2.8VCT713: 2.8V LDO Regulator
					f) TC1186-2.85VCT713: 2.85V LDO Regulator
					g) TC1186-3.0VCT713: 3.0V LDO Regulator
					h) TC1186-3.3VCT713: 3.3V LDO Regulator
					i) TC1186-3.6VCT713: 3.6V LDO Regulator
					j) TC1186-4.0VCT713: 4.0V LDO Regulator
					k) TC1186-5.0VCT713: 5.0V LDO Regulator

TC1054/TC1055/TC1186

NOTES:

EEPW 电子产品世界
.com.cn

Note the following details of the code protection feature on Microchip devices:

- Microchip products meet the specification contained in their particular Microchip Data Sheet.
- Microchip believes that its family of products is one of the most secure families of its kind on the market today, when used in the intended manner and under normal conditions.
- There are dishonest and possibly illegal methods used to breach the code protection feature. All of these methods, to our knowledge, require using the Microchip products in a manner outside the operating specifications contained in Microchip's Data Sheets. Most likely, the person doing so is engaged in theft of intellectual property.
- Microchip is willing to work with the customer who is concerned about the integrity of their code.
- Neither Microchip nor any other semiconductor manufacturer can guarantee the security of their code. Code protection does not mean that we are guaranteeing the product as "unbreakable."

Code protection is constantly evolving. We at Microchip are committed to continuously improving the code protection features of our products. Attempts to break Microchip's code protection feature may be a violation of the Digital Millennium Copyright Act. If such acts allow unauthorized access to your software or other copyrighted work, you may have a right to sue for relief under that Act.

Information contained in this publication regarding device applications and the like is provided only for your convenience and may be superseded by updates. It is your responsibility to ensure that your application meets with your specifications. MICROCHIP MAKES NO REPRESENTATIONS OR WARRANTIES OF ANY KIND WHETHER EXPRESS OR IMPLIED, WRITTEN OR ORAL, STATUTORY OR OTHERWISE, RELATED TO THE INFORMATION, INCLUDING BUT NOT LIMITED TO ITS CONDITION, QUALITY, PERFORMANCE, MERCHANTABILITY OR FITNESS FOR PURPOSE. Microchip disclaims all liability arising from this information and its use. Use of Microchip devices in life support and/or safety applications is entirely at the buyer's risk, and the buyer agrees to defend, indemnify and hold harmless Microchip from any and all damages, claims, suits, or expenses resulting from such use. No licenses are conveyed, implicitly or otherwise, under any Microchip intellectual property rights.

Trademarks

The Microchip name and logo, the Microchip logo, Accuron, dsPIC, KEELOQ, KEELOQ logo, microID, MPLAB, PIC, PICmicro, PICSTART, PRO MATE, PowerSmart, rPIC, and SmartShunt are registered trademarks of Microchip Technology Incorporated in the U.S.A. and other countries.

AmpLab, FilterLab, Linear Active Thermistor, Migratable Memory, MXDEV, MXLAB, PS logo, SEEVAL, SmartSensor and The Embedded Control Solutions Company are registered trademarks of Microchip Technology Incorporated in the U.S.A.

Analog-for-the-Digital Age, Application Maestro, CodeGuard, dsPICDEM, dsPICDEM.net, dsPICworks, ECAN, ECONOMONITOR, FanSense, FlexROM, fuzzyLAB, In-Circuit Serial Programming, ICSP, ICEPIC, Mindi, MiWi, MPASM, MPLAB Certified logo, MPLIB, MPLINK, PICKit, PICDEM, PICDEM.net, PICLAB, PICtail, PowerCal, PowerInfo, PowerMate, PowerTool, REAL ICE, rLAB, rPICDEM, Select Mode, Smart Serial, SmartTel, Total Endurance, UNI/O, WiperLock and ZENA are trademarks of Microchip Technology Incorporated in the U.S.A. and other countries.

SQTP is a service mark of Microchip Technology Incorporated in the U.S.A.

All other trademarks mentioned herein are property of their respective companies.

© 2007, Microchip Technology Incorporated, Printed in the U.S.A., All Rights Reserved.

 Printed on recycled paper.

**QUALITY MANAGEMENT SYSTEM
CERTIFIED BY DNV
== ISO/TS 16949:2002 ==**

Microchip received ISO/TS-16949:2002 certification for its worldwide headquarters, design and wafer fabrication facilities in Chandler and Tempe, Arizona, Gresham, Oregon and Mountain View, California. The Company's quality system processes and procedures are for its PIC[®] MCUs and dsPIC[®] DSCs, KEELOQ[®] code hopping devices, Serial EEPROMs, microperipherals, nonvolatile memory and analog products. In addition, Microchip's quality system for the design and manufacture of development systems is ISO 9001:2000 certified.



WORLDWIDE SALES AND SERVICE

AMERICAS

Corporate Office
2355 West Chandler Blvd.
Chandler, AZ 85224-6199
Tel: 480-792-7200
Fax: 480-792-7277
Technical Support:
<http://support.microchip.com>
Web Address:
www.microchip.com

Atlanta
Duluth, GA
Tel: 678-957-9614
Fax: 678-957-1455

Boston
Westborough, MA
Tel: 774-760-0087
Fax: 774-760-0088

Chicago
Itasca, IL
Tel: 630-285-0071
Fax: 630-285-0075

Dallas
Addison, TX
Tel: 972-818-7423
Fax: 972-818-2924

Detroit
Farmington Hills, MI
Tel: 248-538-2250
Fax: 248-538-2260

Kokomo
Kokomo, IN
Tel: 765-864-8360
Fax: 765-864-8387

Los Angeles
Mission Viejo, CA
Tel: 949-462-9523
Fax: 949-462-9608

Santa Clara
Santa Clara, CA
Tel: 408-961-6444
Fax: 408-961-6445

Toronto
Mississauga, Ontario,
Canada
Tel: 905-673-0699
Fax: 905-673-6509

ASIA/PACIFIC

Asia Pacific Office
Suites 3707-14, 37th Floor
Tower 6, The Gateway
Harbour City, Kowloon
Hong Kong
Tel: 852-2401-1200
Fax: 852-2401-3431

Australia - Sydney
Tel: 61-2-9868-6733
Fax: 61-2-9868-6755

China - Beijing
Tel: 86-10-8528-2100
Fax: 86-10-8528-2104

China - Chengdu
Tel: 86-28-8665-5511
Fax: 86-28-8665-7889

China - Fuzhou
Tel: 86-591-8750-3506
Fax: 86-591-8750-3521

China - Hong Kong SAR
Tel: 852-2401-1200
Fax: 852-2401-3431

China - Qingdao
Tel: 86-532-8502-7355
Fax: 86-532-8502-7205

China - Shanghai
Tel: 86-21-5407-5533
Fax: 86-21-5407-5066

China - Shenyang
Tel: 86-24-2334-2829
Fax: 86-24-2334-2393

China - Shenzhen
Tel: 86-755-8203-2660
Fax: 86-755-8203-1760

China - Shunde
Tel: 86-757-2839-5507
Fax: 86-757-2839-5571

China - Wuhan
Tel: 86-27-5980-5300
Fax: 86-27-5980-5118

China - Xian
Tel: 86-29-8833-7250
Fax: 86-29-8833-7256

ASIA/PACIFIC

India - Bangalore
Tel: 91-80-4182-8400
Fax: 91-80-4182-8422

India - New Delhi
Tel: 91-11-4160-8631
Fax: 91-11-4160-8632

India - Pune
Tel: 91-20-2566-1512
Fax: 91-20-2566-1513

Japan - Yokohama
Tel: 81-45-471-6166
Fax: 81-45-471-6122

Korea - Gumi
Tel: 82-54-473-4301
Fax: 82-54-473-4302

Korea - Seoul
Tel: 82-2-554-7200
Fax: 82-2-558-5932 or
82-2-558-5934

Malaysia - Penang
Tel: 60-4-646-8870
Fax: 60-4-646-5086

Philippines - Manila
Tel: 63-2-634-9065
Fax: 63-2-634-9069

Singapore
Tel: 65-6334-8870
Fax: 65-6334-8850

Taiwan - Hsin Chu
Tel: 886-3-572-9526
Fax: 886-3-572-6459

Taiwan - Kaohsiung
Tel: 886-7-536-4818
Fax: 886-7-536-4803

Taiwan - Taipei
Tel: 886-2-2500-6610
Fax: 886-2-2508-0102

Thailand - Bangkok
Tel: 66-2-694-1351
Fax: 66-2-694-1350

EUROPE

Austria - Wels
Tel: 43-7242-2244-39
Fax: 43-7242-2244-393

Denmark - Copenhagen
Tel: 45-4450-2828
Fax: 45-4485-2829

France - Paris
Tel: 33-1-69-53-63-20
Fax: 33-1-69-30-90-79

Germany - Munich
Tel: 49-89-627-144-0
Fax: 49-89-627-144-44

Italy - Milan
Tel: 39-0331-742611
Fax: 39-0331-466781

Netherlands - Druen
Tel: 31-416-690399
Fax: 31-416-690340

Spain - Madrid
Tel: 34-91-708-08-90
Fax: 34-91-708-08-91

UK - Wokingham
Tel: 44-118-921-5869
Fax: 44-118-921-5820