

## 6A High-Speed MOSFET Drivers

### Features

- Latch-Up Protected: Will Withstand >1.5A Reverse Output Current
- Logic Input Will Withstand Negative Swing Up To 5V
- ESD Protected: 4 kV
- Matched Rise and Fall Times:
  - 25 ns (2500 pF load)
- High Peak Output Current: 6A
- Wide Input Supply Voltage Operating Range:
  - 4.5V to 18V
- High Capacitive Load Drive Capability: 10,000 pF
- Short Delay Time: 55 ns (typ.)
- CMOS/TTL Compatible Input
- Low Supply Current With Logic '1' Input:
  - 450  $\mu$ A (typ.)
- Low Output Impedance: 2.5 $\Omega$
- Output Voltage Swing to Within 25 mV of Ground or  $V_{DD}$
- Space-Saving 8-Pin SOIC and 8-Pin 6x5 DFN Packages

### Applications

- Switch-Mode Power Supplies
- Motor Controls
- Pulse Transformer Driver
- Class D Switching Amplifiers

### General Description

The TC4420/TC4429 are 6A (peak), single-output MOSFET drivers. The TC4429 is an inverting driver (pin-compatible with the TC429), while the TC4420 is a non-inverting driver. These drivers are fabricated in CMOS for lower power and more efficient operation versus bipolar drivers.

Both devices have TTL/CMOS compatible inputs that can be driven as high as  $V_{DD} + 0.3V$  or as low as  $-5V$  without upset or damage to the device. This eliminates the need for external level-shifting circuitry and its associated cost and size. The output swing is rail-to-rail, ensuring better drive voltage margin, especially during power-up/power-down sequencing. Propagational delay time is only 55 ns (typ.) and the output rise and fall times are only 25 ns (typ.) into 2500 pF across the usable power supply range.

Unlike other drivers, the TC4420/TC4429 are virtually latch-up proof. They replace three or more discrete components, saving PCB area, parts and improving overall system reliability.

### Package Types<sup>(1)</sup>

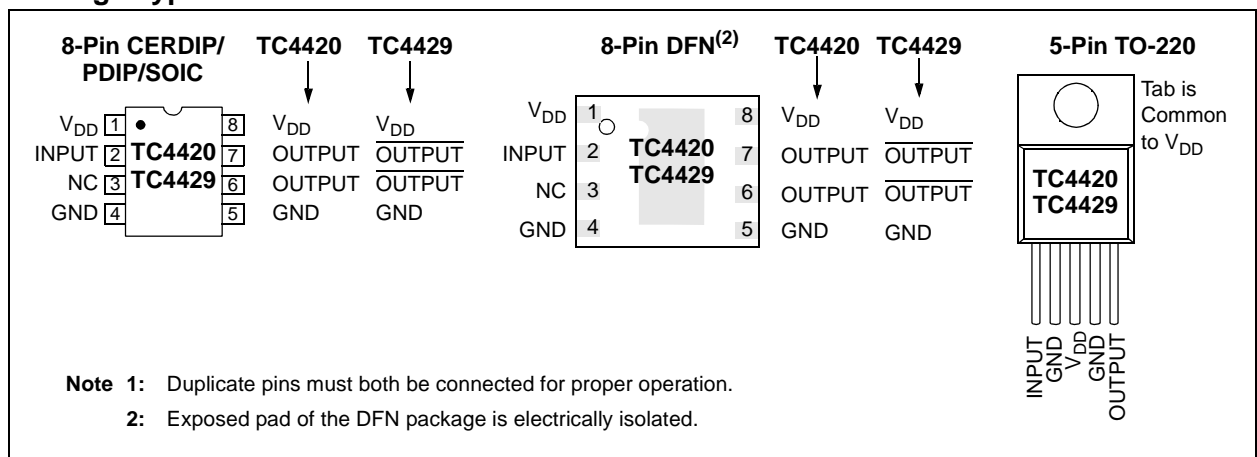

# TC4420/TC4429

## Functional Block Diagram

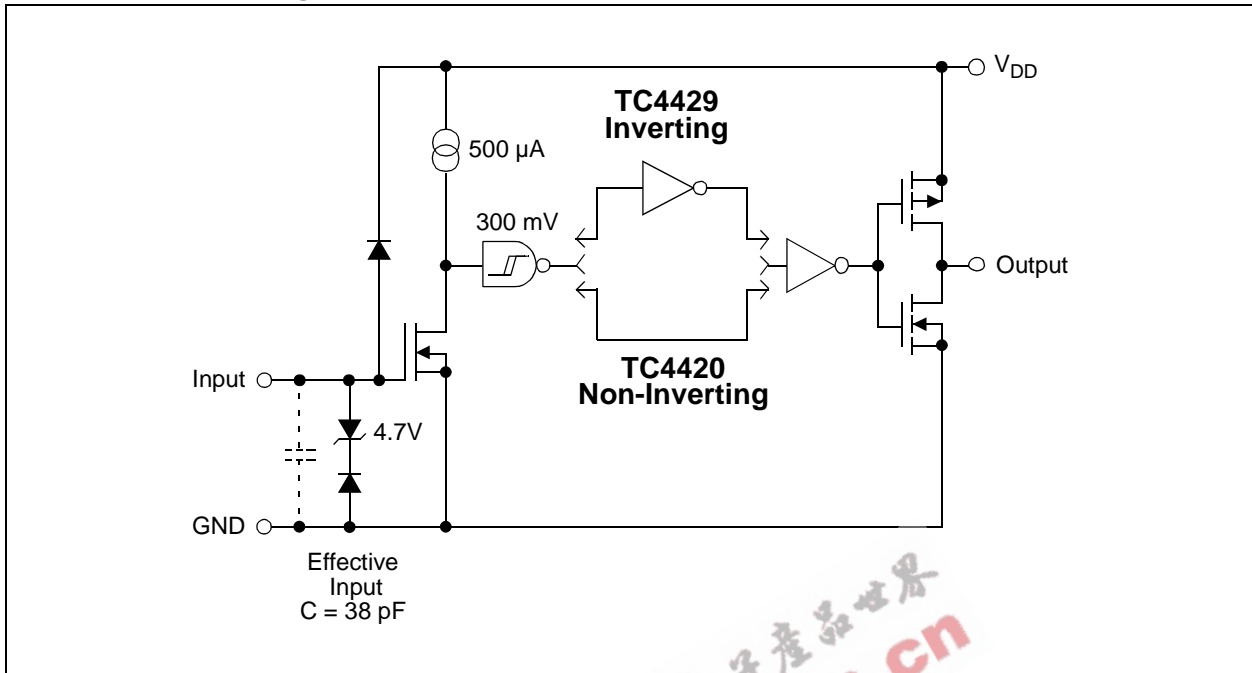

## 1.0 ELECTRICAL CHARACTERISTICS

### Absolute Maximum Ratings†

Supply Voltage .....	+20V
Input Voltage .....	- 5V to $V_{DD} + 0.3V$
Input Current ( $V_{IN} > V_{DD}$ ).....	50 mA
Power Dissipation ( $T_A \leq 70^\circ C$ )	
5-Pin TO-220 .....	1.6W
CERDIP .....	800 mW
DFN .....	<b>Note 2</b>
PDIP .....	730 mW
SOIC.....	470 mW
Package Power Dissipation ( $T_A \leq 25^\circ C$ )	
5-Pin TO-220 (With Heatsink) .....	12.5W
Thermal Impedances (To Case)	
5-Pin TO-220 $R_{\theta J-C}$ .....	10°C/W

† Stresses above those listed under "Absolute Maximum Ratings" may cause permanent damage to the device. These are stress ratings only and functional operation of the device at these or any other conditions above those indicated in the operation sections of the specifications is not implied. Exposure to Absolute Maximum Rating conditions for extended periods may affect device reliability.

### DC CHARACTERISTICS

Electrical Specifications: Unless otherwise noted, $T_A = +25^\circ C$ with $4.5V \leq V_{DD} \leq 18V$ .						
Parameters	Sym	Min	Typ	Max	Units	Conditions
<b>Input</b>						
Logic '1', High Input Voltage	$V_{IH}$	2.4	1.8	—	V	
Logic '0', Low Input Voltage	$V_{IL}$	—	1.3	0.8	V	
Input Voltage Range	$V_{IN}$	-5	—	$V_{DD}+0.3$	V	
Input Current	$I_{IN}$	-10	—	+10	$\mu A$	$0V \leq V_{IN} \leq V_{DD}$
<b>Output</b>						
High Output Voltage	$V_{OH}$	$V_{DD} - 0.025$	—	—	V	DC TEST
Low Output Voltage	$V_{OL}$	—	—	0.025	V	DC TEST
Output Resistance, High	$R_{OH}$	—	2.1	2.8	$\Omega$	$I_{OUT} = 10 \text{ mA}, V_{DD} = 18V$
Output Resistance, Low	$R_{OL}$	—	1.5	2.5	$\Omega$	$I_{OUT} = 10 \text{ mA}, V_{DD} = 18V$
Peak Output Current	$I_{PK}$	—	6.0	—	A	$V_{DD} = 18V$
Latch-Up Protection Withstand Reverse Current	$I_{REV}$	—	> 1.5	—	A	Duty cycle $\leq 2\%$ , $t \leq 300 \mu\text{sec}$
<b>Switching Time (Note 1)</b>						
Rise Time	$t_R$	—	25	35	ns	Figure 4-1, $C_L = 2,500 \text{ pF}$
Fall Time	$t_F$	—	25	35	ns	Figure 4-1, $C_L = 2,500 \text{ pF}$
Delay Time	$t_{D1}$	—	55	75	ns	Figure 4-1
Delay Time	$t_{D2}$	—	55	75	ns	Figure 4-1
<b>Power Supply</b>						
Power Supply Current	$I_S$	—	0.45	1.5	mA	$V_{IN} = 3V$
		—	55	150	$\mu A$	$V_{IN} = 0V$
Operating Input Voltage	$V_{DD}$	4.5	—	18	V	

**Note 1:** Switching times ensured by design.

**2:** Package power dissipation is dependent on the copper pad area on the PCB.

# TC4420/TC4429

## DC CHARACTERISTICS (OVER OPERATING TEMPERATURE RANGE)

Electrical Specifications: Unless otherwise noted, over operating temperature range with $4.5V \leq V_{DD} \leq 18V$ .						
Parameters	Sym	Min	Typ	Max	Units	Conditions
<b>Input</b>						
Logic '1', High Input Voltage	$V_{IH}$	2.4	—	—	V	
Logic '0', Low Input Voltage	$V_{IL}$	—	—	0.8	V	
Input Voltage Range	$V_{IN}$	-5	—	$V_{DD} + 0.3$	V	
Input Current	$I_{IN}$	-10	—	+10	$\mu A$	$0V \leq V_{IN} \leq V_{DD}$
<b>Output</b>						
High Output Voltage	$V_{OH}$	$V_{DD} - 0.025$	—	—	V	DC TEST
Low Output Voltage	$V_{OL}$	—	—	0.025	V	DC TEST
Output Resistance, High	$R_{OH}$	—	3	5	$\Omega$	$I_{OUT} = 10 \text{ mA}$ , $V_{DD} = 18V$
Output Resistance, Low	$R_{OL}$	—	2.3	5	$\Omega$	$I_{OUT} = 10 \text{ mA}$ , $V_{DD} = 18V$
<b>Switching Time (Note 1)</b>						
Rise Time	$t_R$	—	32	60	ns	Figure 4-1, $C_L = 2,500 \text{ pF}$
Fall Time	$t_F$	—	34	60	ns	Figure 4-1, $C_L = 2,500 \text{ pF}$
Delay Time	$t_{D1}$	—	50	100	ns	Figure 4-1
Delay Time	$t_{D2}$	—	65	100	ns	Figure 4-1
<b>Power Supply</b>						
Power Supply Current	$I_S$	—	0.45 60	3 400	mA $\mu A$	$V_{IN} = 3V$ $V_{IN} = 0V$
Operating Input Voltage	$V_{DD}$	4.5	—	18	V	

**Note 1:** Switching times ensured by design.

## TEMPERATURE CHARACTERISTICS

Electrical Specifications: Unless otherwise noted, all parameters apply with $4.5V \leq V_{DD} \leq 18V$ .						
Parameters	Sym	Min	Typ	Max	Units	Conditions
<b>Temperature Ranges</b>						
Specified Temperature Range (C)	$T_A$	0	—	+70	$^{\circ}C$	
Specified Temperature Range (I)	$T_A$	-25	—	+85	$^{\circ}C$	
Specified Temperature Range (E)	$T_A$	-40	—	+85	$^{\circ}C$	
Specified Temperature Range (V)	$T_A$	-40	—	+125	$^{\circ}C$	
Maximum Junction Temperature	$T_J$	—	—	+150	$^{\circ}C$	
Storage Temperature Range	$T_A$	-65	—	+150	$^{\circ}C$	
<b>Package Thermal Resistances</b>						
Thermal Resistance, 5L-TO-220	$\theta_{JA}$	—	71	—	$^{\circ}C/W$	
Thermal Resistance, 8L-CERDIP	$\theta_{JA}$	—	150	—	$^{\circ}C/W$	
Thermal Resistance, 8L-6x5 DFN	$\theta_{JA}$	—	33.2	—	$^{\circ}C/W$	Typical four-layer board with vias to ground plane.
Thermal Resistance, 8L-PDIP	$\theta_{JA}$	—	125	—	$^{\circ}C/W$	
Thermal Resistance, 8L-SOIC	$\theta_{JA}$	—	155	—	$^{\circ}C/W$	

## 2.0 TYPICAL PERFORMANCE CURVES

**Note:** The graphs and tables provided following this note are a statistical summary based on a limited number of samples and are provided for informational purposes only. The performance characteristics listed herein are not tested or guaranteed. In some graphs or tables, the data presented may be outside the specified operating range (e.g., outside specified power supply range) and therefore outside the warranted range.

**Note:** Unless otherwise indicated,  $T_A = +25^\circ\text{C}$  with  $4.5\text{V} \leq V_{DD} \leq 18\text{V}$ .

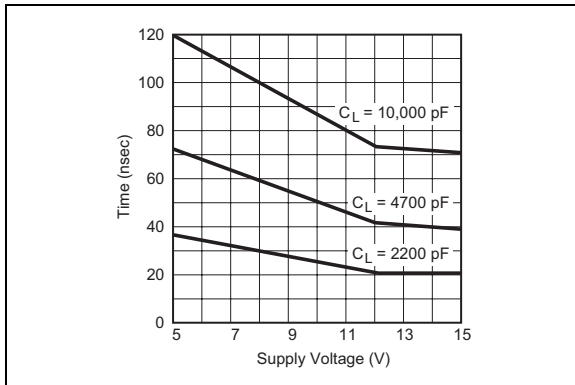

**FIGURE 2-1:** Rise Time vs. Supply Voltage.

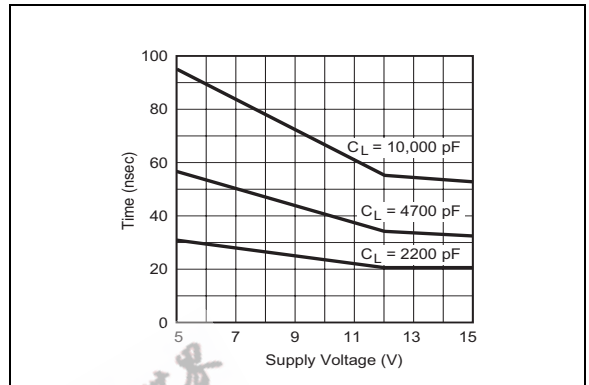

**FIGURE 2-4:** Fall Time vs. Supply Voltage.

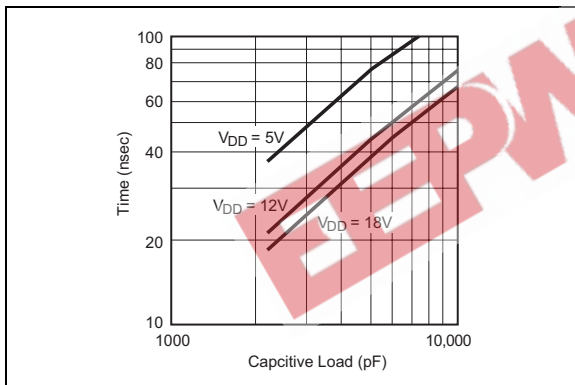

**FIGURE 2-2:** Rise Time vs. Capacitive Load.

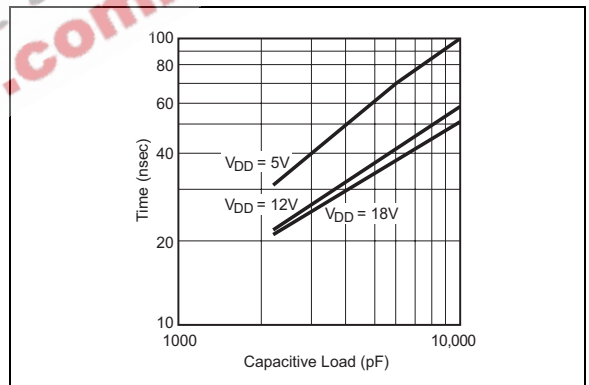

**FIGURE 2-5:** Fall Time vs. Capacitive Load.

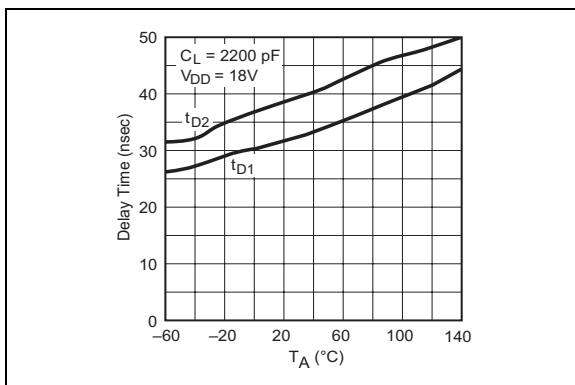

**FIGURE 2-3:** Propagation Delay Time vs. Temperature.

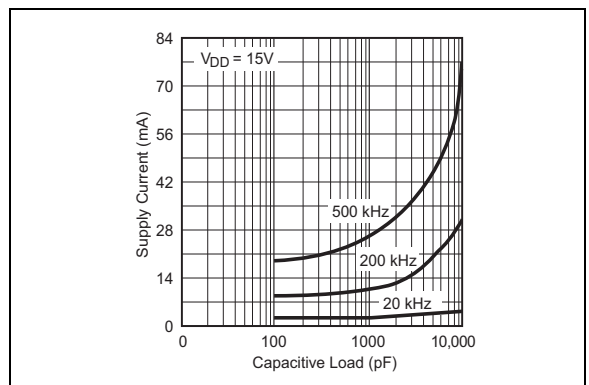

**FIGURE 2-6:** Supply Current vs. Capacitive Load.

# TC4420/TC4429

**Note:** Unless otherwise indicated,  $T_A = +25^\circ\text{C}$  with  $4.5\text{V} \leq V_{DD} \leq 18\text{V}$ .

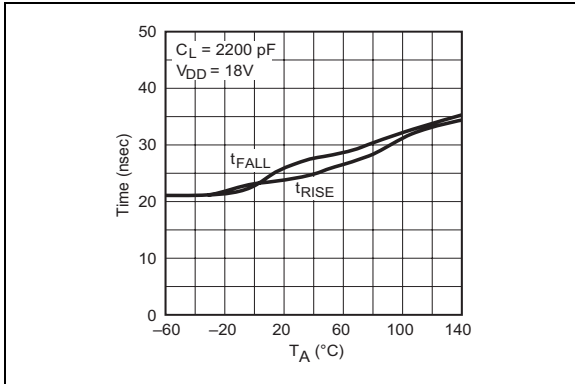

**FIGURE 2-7:** Rise and Fall Times vs. Temperature.

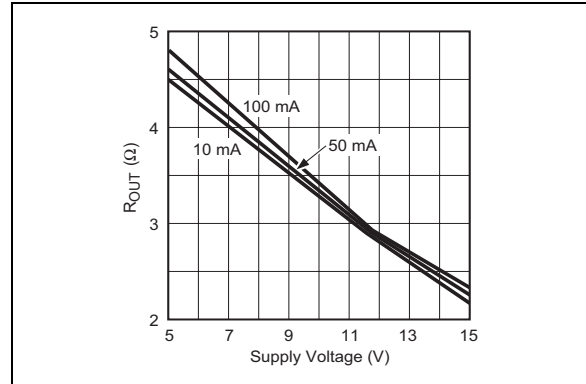

**FIGURE 2-10:** High-State Output Resistance vs. Supply Voltage.

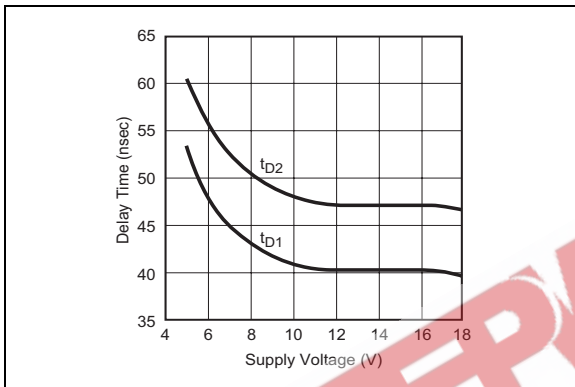

**FIGURE 2-8:** Propagation Delay Time vs. Supply Voltage.

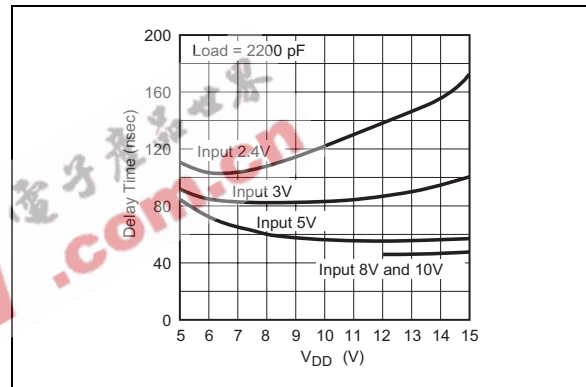

**FIGURE 2-11:** Effect of Input Amplitude on Propagation Delay.

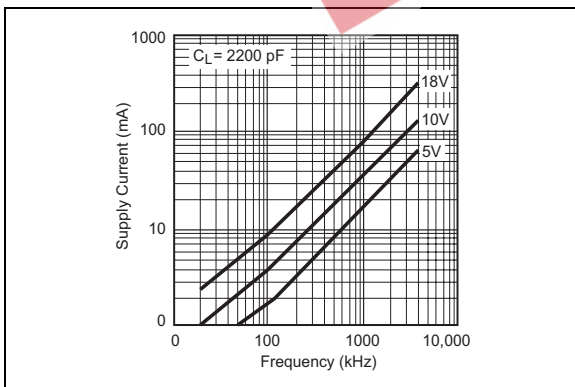

**FIGURE 2-9:** Supply Current vs. Frequency.

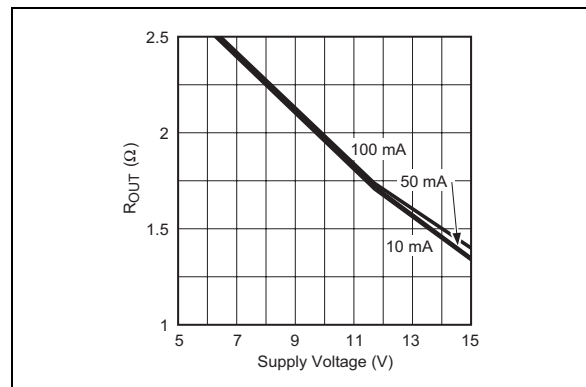

**FIGURE 2-12:** Low-State Output Resistance vs. Supply Voltage.

# TC4420/TC4429

**Note:** Unless otherwise indicated,  $T_A = +25^\circ\text{C}$  with  $4.5\text{V} \leq V_{DD} \leq 18\text{V}$ .

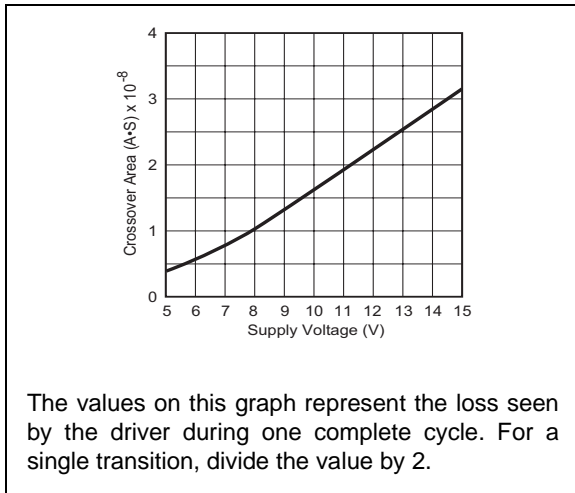

**FIGURE 2-13:** Crossover Energy.

EEPW 电子产品世界  
.com.cn

# TC4420/TC4429

## 3.0 PIN DESCRIPTIONS

The descriptions of the pins are listed in Table 3-1.

TABLE 3-1: PIN FUNCTION TABLE

Pin No. 8-Pin CERDIP/ PDIP/SOIC	Pin No. 8-Pin DFN	Pin No. 5-Pin TO-220	Symbol	Description
1	1	—	$V_{DD}$	Supply input, 4.5V to 18V
2	2	1	INPUT	Control input, TTL/CMOS compatible input
3	3	—	NC	No Connection
4	4	2	GND	Ground
5	5	4	GND	Ground
6	6	5	OUTPUT	CMOS push-pull output
7	7	—	OUTPUT	CMOS push-pull output
8	8	3	$V_{DD}$	Supply input, 4.5V to 18V
—	PAD	—	NC	Exposed Metal Pad
—	—	TAB	$V_{DD}$	Metal Tab is at the $V_{DD}$ Potential

### 3.1 Supply Input ( $V_{DD}$ )

The  $V_{DD}$  input is the bias supply for the MOSFET driver and is rated for 4.5V to 18V with respect to the ground pins. The  $V_{DD}$  input should be bypassed to ground with a local ceramic capacitor. The value of the capacitor should be chosen based on the capacitive load that is being driven. A minimum value of 1.0  $\mu$ F is suggested.

### 3.2 Control Input

The MOSFET driver input is a high-impedance, TTL/CMOS compatible input. The input circuitry of the TC4420/TC4429 MOSFET driver also has a “speed-up” capacitor. This helps to decrease the propagation delay times of the driver. Because of this, input signals with slow rising or falling edges should not be used, as this can result in double-pulsing of the MOSFET driver output.

### 3.3 CMOS Push-Pull Output

The MOSFET driver output is a low-impedance, CMOS, push-pull style output capable of driving a capacitive load with 6.0A peak currents. The MOSFET driver output is capable of withstanding 1.5A peak reverse currents of either polarity.

### 3.4 Ground

The ground pins are the return path for the bias current and the high peak currents that discharge the load capacitor. The ground pins should be tied into a ground plane or have very short traces to the bias supply source return.

### 3.5 Exposed Metal Pad

The exposed metal pad of the 6x5 DFN package is not internally connected to any potential. Therefore, this pad can be connected to a ground plane or other copper plane on a printed circuit board (PCB) to aid in heat removal from the package.



## 4.0 APPLICATIONS INFORMATION

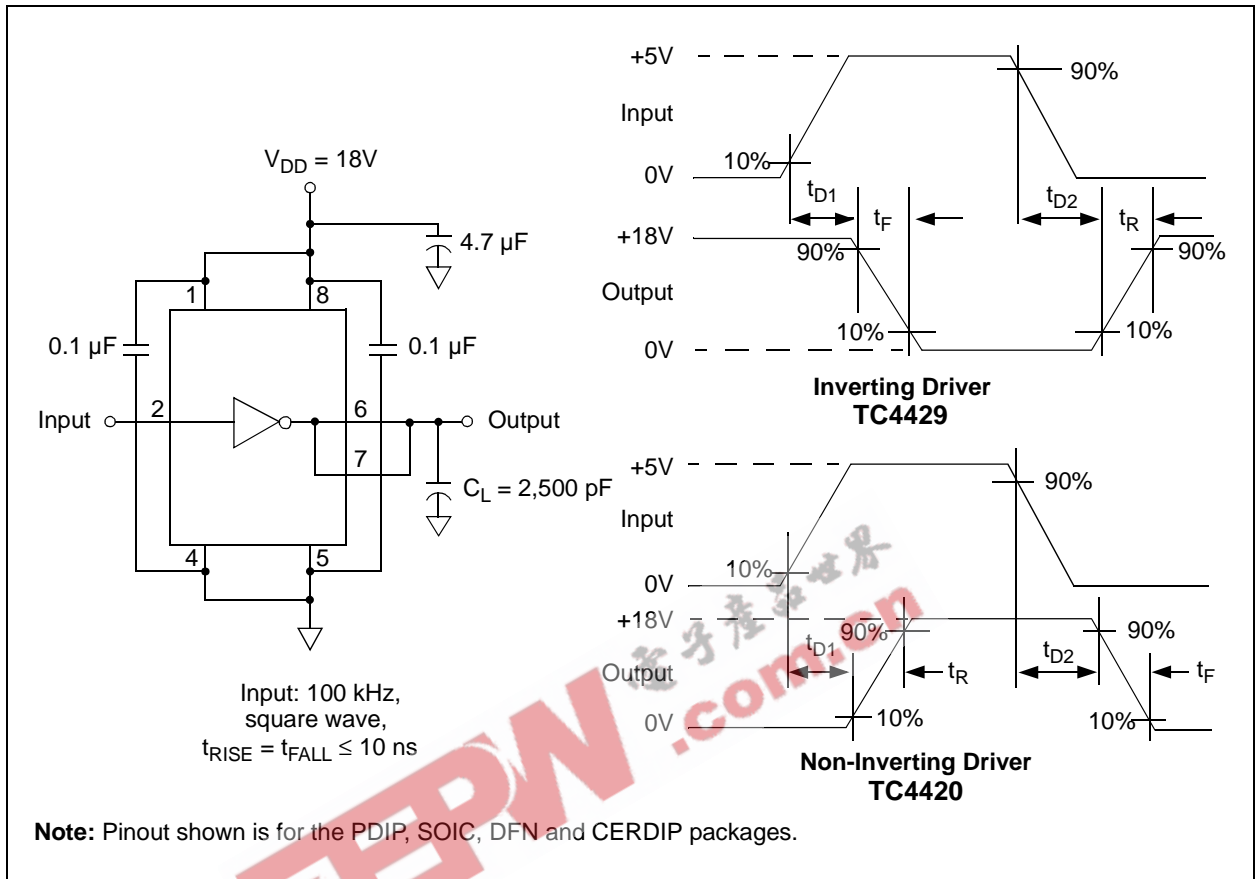

**FIGURE 4-1:** Switching Time Test Circuits.

# TC4420/TC4429

## 5.0 PACKAGING INFORMATION

### 5.1 Package Marking Information

5-Lead TO-220

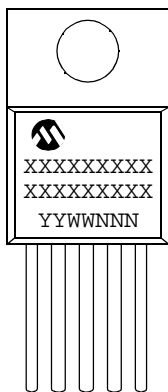

Example:



8-Lead CERDIP (300 mil)

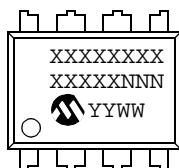

Example:

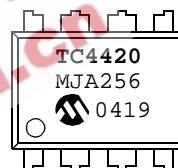

8-Lead DFN

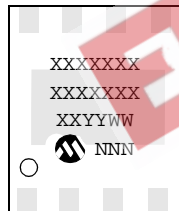

Example:

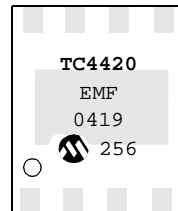

**Legend:** XX...X Customer specific information\*  
YY Year code (last 2 digits of calendar year)  
WW Week code (week of January 1 is week '01')  
NNN Alphanumeric traceability code

**Note:** In the event the full Microchip part number cannot be marked on one line, it will be carried over to the next line thus limiting the number of available characters for customer specific information.

\* Standard OTP marking consists of Microchip part number, year code, week code, and traceability code.

# TC4420/TC4429

## Package Marking Information (Continued)

8-Lead PDIP (300 mil)

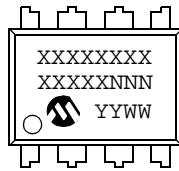

Example:

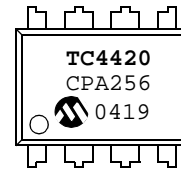

8-Lead SOIC (150 mil)

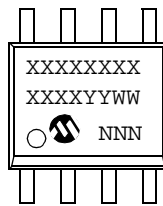

Example:

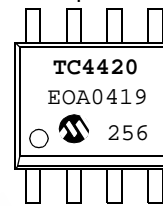

EEPW 电子产品世界  
.com.cn

# TC4420/TC4429

## 5-Lead Plastic Transistor Outline (AT) (TO-220)

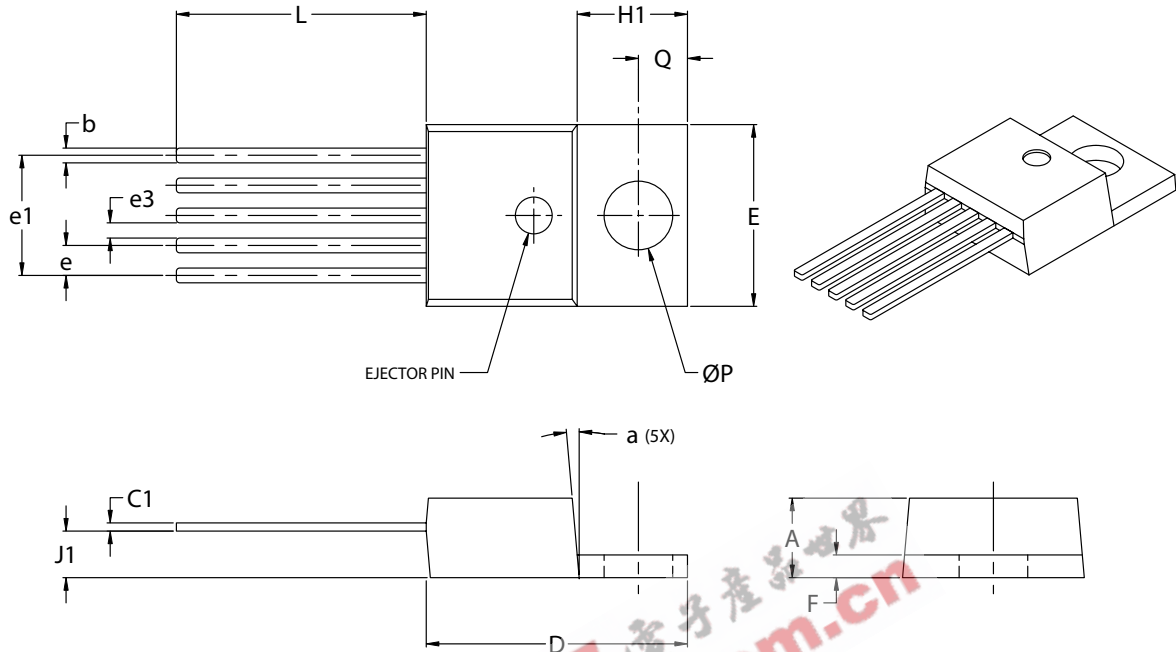

Dimension Limits	Units	INCHES*		MILLIMETERS	
		MIN	MAX	MIN	MAX
Lead Pitch	e	.060	.072	1.52	1.83
Overall Lead Centers	e1	.263	.273	6.68	6.93
Space Between Leads	e3	.030	.040	0.76	1.02
Overall Height	A	.160	.190	4.06	4.83
Overall Width	E	.385	.415	9.78	10.54
Overall Length	D	.560	.590	14.22	14.99
Flag Length	H1	.234	.258	5.94	6.55
Flag Thickness	F	.045	.055	1.14	1.40
Through Hole Center	Q	.103	.113	2.62	2.87
Through Hole Diameter	P	.146	.156	3.71	3.96
Lead Length	L	.540	.560	13.72	14.22
Base to Bottom of Lead	J1	.090	.115	2.29	2.92
Lead Thickness	C1	.014	.022	0.36	0.56
Lead Width	b	.025	.040	0.64	1.02
Mold Draft Angle	a	3°	7°	3°	7°

\*Controlling Parameter

Notes:

Dimensions D and E1 do not include mold flash or protrusions. Mold flash or protrusions shall not exceed .010" (0.254mm) per side.

JEDEC equivalent: TO-220

Drawing No. C04-036

# TC4420/TC4429

## 8-Lead Ceramic Dual In-line – 300 mil (JA) (CERDIP)

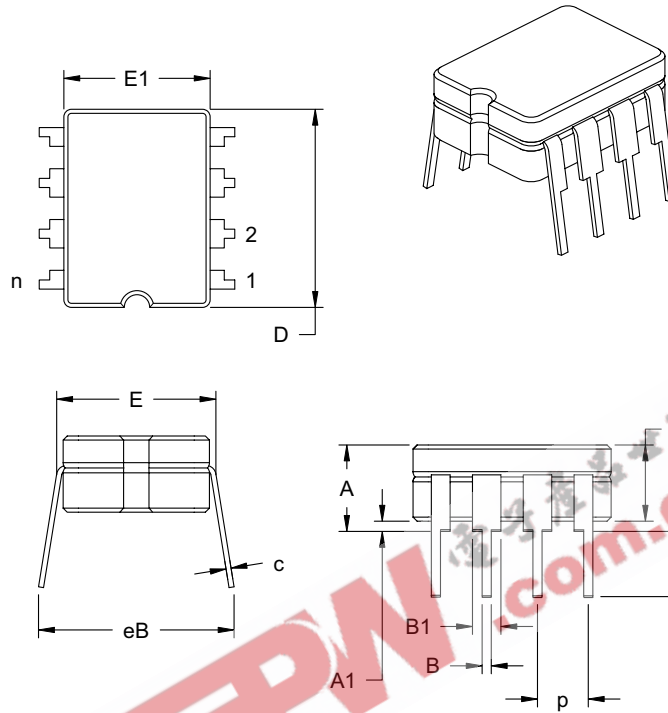

Dimension Limits	Units	INCHES*			MILLIMETERS		
		MIN	NOM	MAX	MIN	NOM	MAX
Number of Pins	n		8			8	
Pitch	p		.100			2.54	
Top to Seating Plane	A	.160	.180	.200	4.06	4.57	5.08
Standoff §	A1	.020	.030	.040	0.51	0.77	1.02
Shoulder to Shoulder Width	E	.290	.305	.320	7.37	7.75	8.13
Ceramic Pkg. Width	E1	.230	.265	.300	5.84	6.73	7.62
Overall Length	D	.370	.385	.400	9.40	9.78	10.16
Tip to Seating Plane	L	.125	.163	.200	3.18	4.13	5.08
Lead Thickness	c	.008	.012	.015	0.20	0.29	0.38
Upper Lead Width	B1	.045	.055	.065	1.14	1.40	1.65
Lower Lead Width	B	.016	.018	.020	0.41	0.46	0.51
Overall Row Spacing	eB	.320	.360	.400	8.13	9.15	10.16

\*Controlling Parameter

JEDEC Equivalent: MS-030

Drawing No. C04-010

# TC4420/TC4429

## 8-Lead Plastic Dual Flat No Lead Package (MF) 6x5 mm Body (DFN-S) – Saw Singulated

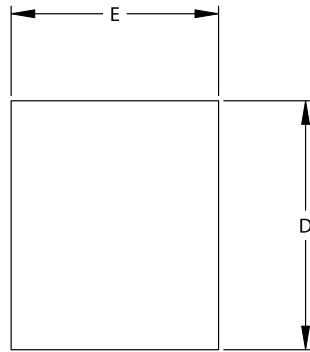

TOP VIEW

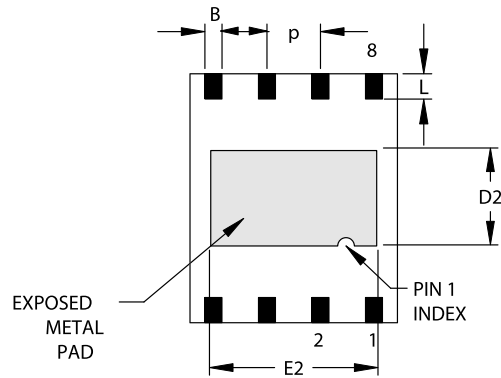

BOTTOM VIEW

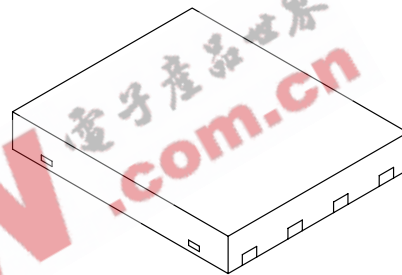
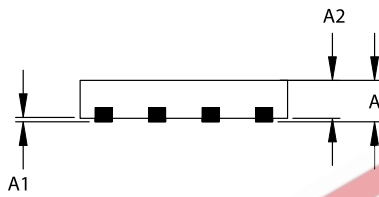

Dimension Limits	Units	INCHES			MILLIMETERS*		
		MIN	NOM	MAX	MIN	NOM	MAX
Number of Pins	n	8			8		
Pitch	P	.050 BSC			1.27 BSC		
Overall Height	A	.033	.035	.037	0.85	0.90	0.95
Package Thickness	A2	.031	.035	.037	0.80	0.89	0.95
Standoff	A1	.000	.0004	.002	0.00	0.01	0.05
Base Thickness	A3	.007	.008	.009	0.17	0.20	0.23
Overall Length	E	.195	.197	.199	4.95	5.00	5.05
Exposed Pad Length	E2	.152	.157	.163	3.85	4.00	4.15
Overall Width	D	.234	.236	.238	5.95	6.00	6.05
Exposed Pad Width	D2	.089	.091	.093	2.25	2.30	2.35
Lead Width	B	.014	.016	.019	0.35	0.40	0.47
Lead Length	L	.024		.026	0.60		0.65

Notes:

JEDEC equivalent: MO-220

Drawing No. C04-122

Revised 11/3/03

# TC4420/TC4429

## 8-Lead Plastic Dual In-line (PA) – 300 mil (PDIP)

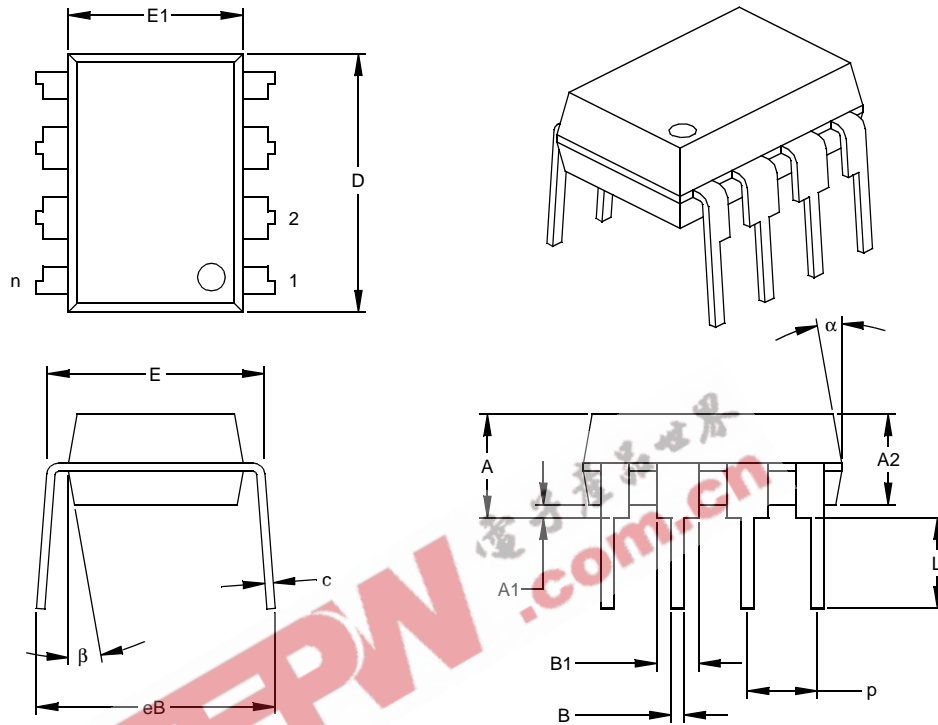

Dimension	Units	INCHES*			MILLIMETERS		
		MIN	NOM	MAX	MIN	NOM	MAX
Number of Pins	n		8			8	
Pitch	P		.100			2.54	
Top to Seating Plane	A	.140	.155	.170	3.56	3.94	4.32
Molded Package Thickness	A2	.115	.130	.145	2.92	3.30	3.68
Base to Seating Plane	A1	.015			0.38		
Shoulder to Shoulder Width	E	.300	.313	.325	7.62	7.94	8.26
Molded Package Width	E1	.240	.250	.260	6.10	6.35	6.60
Overall Length	D	.360	.373	.385	9.14	9.46	9.78
Tip to Seating Plane	L	.125	.130	.135	3.18	3.30	3.43
Lead Thickness	c	.008	.012	.015	0.20	0.29	0.38
Upper Lead Width	B1	.045	.058	.070	1.14	1.46	1.78
Lower Lead Width	B	.014	.018	.022	0.36	0.46	0.56
Overall Row Spacing	§ eB	.310	.370	.430	7.87	9.40	10.92
Mold Draft Angle Top	α	5	10	15	5	10	15
Mold Draft Angle Bottom	β	5	10	15	5	10	15

\* Controlling Parameter  
 § Significant Characteristic

Notes:  
 Dimensions D and E1 do not include mold flash or protrusions. Mold flash or protrusions shall not exceed .010" (0.254mm) per side.  
 JEDEC Equivalent: MS-001  
 Drawing No. C04-018

# TC4420/TC4429

## 8-Lead Plastic Small Outline (OA) – Narrow, 150 mil (SOIC)

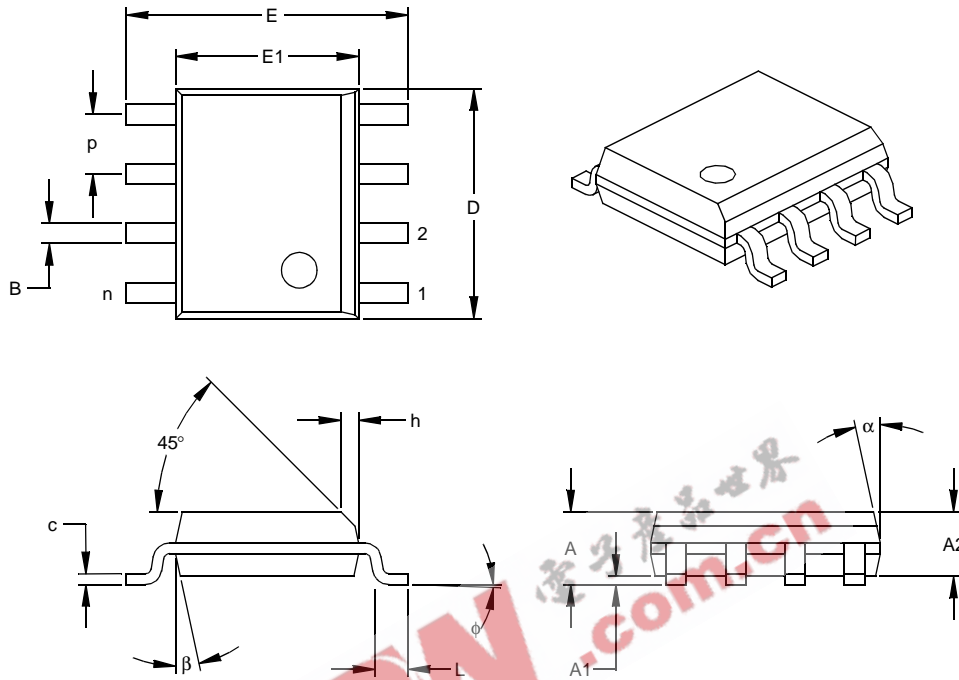

Dimension	Units	INCHES*			MILLIMETERS		
		MIN	NOM	MAX	MIN	NOM	MAX
Number of Pins	n		8			8	
Pitch	P		.050			1.27	
Overall Height	A	.053	.061	.069	1.35	1.55	1.75
Molded Package Thickness	A2	.052	.056	.061	1.32	1.42	1.55
Standoff §	A1	.004	.007	.010	0.10	0.18	0.25
Overall Width	E	.228	.237	.244	5.79	6.02	6.20
Molded Package Width	E1	.146	.154	.157	3.71	3.91	3.99
Overall Length	D	.189	.193	.197	4.80	4.90	5.00
Chamfer Distance	h	.010	.015	.020	0.25	0.38	0.51
Foot Length	L	.019	.025	.030	0.48	0.62	0.76
Foot Angle	φ	0	4	8	0	4	8
Lead Thickness	c	.008	.009	.010	0.20	0.23	0.25
Lead Width	B	.013	.017	.020	0.33	0.42	0.51
Mold Draft Angle Top	α	0	12	15	0	12	15
Mold Draft Angle Bottom	β	0	12	15	0	12	15

\* Controlling Parameter  
 § Significant Characteristic

Notes:  
 Dimensions D and E1 do not include mold flash or protrusions. Mold flash or protrusions shall not exceed .010" (0.254mm) per side.  
 JEDEC Equivalent: MS-012  
 Drawing No. C04-057



# TC4420/TC4429

## PRODUCT IDENTIFICATION SYSTEM

To order or obtain information, e.g., on pricing or delivery, refer to the factory or the listed sales office.

<u>PART NO.</u>	<u>X</u>	<u>XX</u>	<u>XXX</u>	<u>X</u>	<b>Examples:</b>
<b>Device</b>	<b>Temperature Range</b>	<b>Package</b>	<b>Tape and Reel</b>	<b>PB Free</b>	
Device:	TC4420:	6A High-Speed MOSFET Driver, Non-Inverting			a) TC4420CAT: 6A High-Speed MOSFET Driver, Non-inverting, TO-220 package, 0°C to +70°C. b) TC4420EOA: 6A High-Speed MOSFET Driver, Non-inverting, SOIC package, -40°C to +85°C. c) TC4420VMF: 6A High-Speed MOSFET Driver, Non-inverting, DFN package, -40°C to +125°C.
	TC4429:	6A High-Speed MOSFET Driver, Inverting			
Temperature Range:	C =	0°C to +70°C (PDIP, SOIC, and TO-220 Only)			a) TC4429CAT: 6A High-Speed MOSFET Driver, Inverting, TO-220 package, 0°C to +70°C b) TC4429EPA: 6A High-Speed MOSFET Driver, Inverting, PDIP package, -40°C to +85°C c) TC4429VMF: 6A High-Speed MOSFET Driver, Inverting, DFN package, -40°C to +125°C
	I =	-25°C to +85°C (CERDIP Only)			
	E =	-40°C to +85°C			
	V =	-40°C to +125°C			
Package:	AT =	TO-220, 5-lead (C-Temp Only)			* Available on selected packages. Contact your local sales representative for availability
	JA =	Ceramic Dual In-line (300 mil Body), 8-lead (I-Temp Only)			
	MF =	Dual, Flat, No-Lead (6X5 mm Body), 8-lead			
	MF713 =	Dual, Flat, No-Lead (6X5 mm Body), 8-lead (Tape and Reel)			
	PA =	Plastic DIP (300 mil Body), 8-lead			
	OA =	Plastic SOIC, (150 mil Body), 8-lead			
	OA713 =	Plastic SOIC, (150 mil Body), 8-lead (Tape and Reel)			
PB Free	G =	Lead-Free device*			
		= Blank			

## Sales and Support

### Data Sheets

Products supported by a preliminary Data Sheet may have an errata sheet describing minor operational differences and recommended workarounds. To determine if an errata sheet exists for a particular device, please contact one of the following:

1. Your local Microchip sales office
2. The Microchip Corporate Literature Center U.S. FAX: (480) 792-7277
3. The Microchip Worldwide Site ([www.microchip.com](http://www.microchip.com))

Please specify which device, revision of silicon and Data Sheet (include Literature #) you are using.

### Customer Notification System

Register on our web site ([www.microchip.com/cn](http://www.microchip.com/cn)) to receive the most current information on our products.

# TC4420/TC4429

---

NOTES:

EEPW 电子产品世界  
.com.cn

---

**Note the following details of the code protection feature on Microchip devices:**

- Microchip products meet the specification contained in their particular Microchip Data Sheet.
- Microchip believes that its family of products is one of the most secure families of its kind on the market today, when used in the intended manner and under normal conditions.
- There are dishonest and possibly illegal methods used to breach the code protection feature. All of these methods, to our knowledge, require using the Microchip products in a manner outside the operating specifications contained in Microchip's Data Sheets. Most likely, the person doing so is engaged in theft of intellectual property.
- Microchip is willing to work with the customer who is concerned about the integrity of their code.
- Neither Microchip nor any other semiconductor manufacturer can guarantee the security of their code. Code protection does not mean that we are guaranteeing the product as "unbreakable."

Code protection is constantly evolving. We at Microchip are committed to continuously improving the code protection features of our products. Attempts to break Microchip's code protection feature may be a violation of the Digital Millennium Copyright Act. If such acts allow unauthorized access to your software or other copyrighted work, you may have a right to sue for relief under that Act.

---

Information contained in this publication regarding device applications and the like is intended through suggestion only and may be superseded by updates. It is your responsibility to ensure that your application meets with your specifications. No representation or warranty is given and no liability is assumed by Microchip Technology Incorporated with respect to the accuracy or use of such information, or infringement of patents or other intellectual property rights arising from such use or otherwise. Use of Microchip's products as critical components in life support systems is not authorized except with express written approval by Microchip. No licenses are conveyed, implicitly or otherwise, under any intellectual property rights.

**Trademarks**

The Microchip name and logo, the Microchip logo, Accuron, dsPIC, KEELOQ, microID, MPLAB, PIC, PICmicro, PICSTART, PRO MATE, PowerSmart, rfPIC, and SmartShunt are registered trademarks of Microchip Technology Incorporated in the U.S.A. and other countries.

AmpLab, FilterLab, MXDEV, MXLAB, PICMASTER, SEEVAL, SmartSensor and The Embedded Control Solutions Company are registered trademarks of Microchip Technology Incorporated in the U.S.A.

Analog-for-the-Digital Age, Application Maestro, dsPICDEM, dsPICDEM.net, dsPICworks, ECAN, ECONOMONITOR, FanSense, FlexROM, fuzzyLAB, In-Circuit Serial Programming, ICSP, ICEPIC, Migratable Memory, MPASM, MPLIB, MPLINK, MPSIM, PICkit, PICDEM, PICDEM.net, PICLAB, PICTail, PowerCal, PowerInfo, PowerMate, PowerTool, rLAB, rfPICDEM, Select Mode, Smart Serial, SmartTel and Total Endurance are trademarks of Microchip Technology Incorporated in the U.S.A. and other countries.

SQTP is a service mark of Microchip Technology Incorporated in the U.S.A.

All other trademarks mentioned herein are property of their respective companies.

© 2004, Microchip Technology Incorporated, Printed in the U.S.A., All Rights Reserved.

 Printed on recycled paper.

**QUALITY MANAGEMENT SYSTEM  
CERTIFIED BY DNV  
== ISO/TS 16949:2002 ==**

*Microchip received ISO/TS-16949:2002 quality system certification for its worldwide headquarters, design and wafer fabrication facilities in Chandler and Tempe, Arizona and Mountain View, California in October 2003. The Company's quality system processes and procedures are for its PICmicro® 8-bit MCUs, KEELOQ® code hopping devices, Serial EEPROMs, microperipherals, nonvolatile memory and analog products. In addition, Microchip's quality system for the design and manufacture of development systems is ISO 9001:2000 certified.*



## WORLDWIDE SALES AND SERVICE

### AMERICAS

**Corporate Office**  
2355 West Chandler Blvd.  
Chandler, AZ 85224-6199  
Tel: 480-792-7200  
Fax: 480-792-7277  
Technical Support:  
480-792-7627  
Web Address:  
www.microchip.com

#### Atlanta

Alpharetta, GA  
Tel: 770-640-0034  
Fax: 770-640-0307

#### Boston

Westford, MA  
Tel: 978-692-3848  
Fax: 978-692-3821

#### Chicago

Itasca, IL  
Tel: 630-285-0071  
Fax: 630-285-0075

#### Dallas

Addison, TX  
Tel: 972-818-7423  
Fax: 972-818-2924

#### Detroit

Farmington Hills, MI  
Tel: 248-538-2250  
Fax: 248-538-2260

#### Kokomo

Kokomo, IN  
Tel: 765-864-8360  
Fax: 765-864-8387

#### Los Angeles

Mission Viejo, CA  
Tel: 949-462-9523  
Fax: 949-462-9608

#### San Jose

Mountain View, CA  
Tel: 650-215-1444  
Fax: 650-961-0286

#### Toronto

Mississauga, Ontario,  
Canada  
Tel: 905-673-0699  
Fax: 905-673-6509

### ASIA/PACIFIC

**Australia - Sydney**  
Tel: 61-2-9868-6733  
Fax: 61-2-9868-6755

**China - Beijing**  
Tel: 86-10-8528-2100  
Fax: 86-10-8528-2104

**China - Chengdu**  
Tel: 86-28-8676-6200  
Fax: 86-28-8676-6599

**China - Fuzhou**  
Tel: 86-591-750-3506  
Fax: 86-591-750-3521

#### China - Hong Kong SAR

Tel: 852-2401-1200  
Fax: 852-2401-3431

#### China - Shanghai

Tel: 86-21-6275-5700  
Fax: 86-21-6275-5060

#### China - Shenzhen

Tel: 86-755-8290-1380  
Fax: 86-755-8295-1393

#### China - Shunde

Tel: 86-757-2839-5507  
Fax: 86-757-2839-5571

#### China - Qingdao

Tel: 86-532-502-7355  
Fax: 86-532-502-7205

### ASIA/PACIFIC

**India - Bangalore**  
Tel: 91-80-2229-0061  
Fax: 91-80-2229-0062

**India - New Delhi**  
Tel: 91-11-5160-8632  
Fax: 91-11-5160-8632

**Japan - Kanagawa**  
Tel: 81-45-471-6166  
Fax: 81-45-471-6122

**Korea - Seoul**  
Tel: 82-2-554-7200  
Fax: 82-2-558-5932 or  
82-2-558-5934

**Singapore**  
Tel: 65-6334-8870  
Fax: 65-6334-8850

**Taiwan - Kaohsiung**  
Tel: 886-7-536-4816  
Fax: 886-7-536-4817

**Taiwan - Taipei**  
Tel: 886-2-2500-6610  
Fax: 886-2-2508-0102

**Taiwan - Hsinchu**  
Tel: 886-3-572-9526  
Fax: 886-3-572-6459

### EUROPE

**Austria - Weis**  
Tel: 43-7242-2244-399  
Fax: 43-7242-2244-393

**Denmark - Ballerup**  
Tel: 45-4420-9895  
Fax: 45-4420-9910

**France - Massy**  
Tel: 33-1-69-53-63-20  
Fax: 33-1-69-30-90-79

**Germany - Ismaning**  
Tel: 49-89-627-144-0  
Fax: 49-89-627-144-44

**Italy - Milan**  
Tel: 39-0331-742611  
Fax: 39-0331-466781

**Netherlands - Druen**  
Tel: 31-416-690399  
Fax: 31-416-690340

**England - Berkshire**  
Tel: 44-118-921-5869  
Fax: 44-118-921-5820