

## 50mA and 100mA CMOS LDOs with Shutdown, $\overline{\text{ERROR}}$ Output and $V_{\text{REF}}$ Bypass

### Features:

- 50  $\mu\text{A}$  Ground Current for Longer Battery Life
- Very Low Dropout Voltage
- Choice of 50 mA (TC1072) and 100 mA (TC1073) Output
- High Output Voltage Accuracy
- Standard or Custom Output Voltages
- Power-Saving Shutdown Mode
- $\overline{\text{ERROR}}$  Output Can Be Used as a Low Battery Detector or Processor Reset Generator
- Bypass Input for Ultra Quiet Operation
- Overcurrent and Overtemperature Protection
- Space-Saving 6-Pin SOT-23 Package
- Pin Compatible Upgrades for Bipolar Regulators
- Standard Output Voltage Options:
  - 1.8V, 2.5V, 2.6V, 2.7V, 2.8V, 2.85V, 3.0V, 3.3V, 3.6V, 4.0V, 5.0V
- Other output voltages are available. Please contact Microchip Technology Inc. for details.

### Applications:

- Battery Operated Systems
- Portable Computers
- Medical Instruments
- Instrumentation
- Cellular/GSM/PHS Phones
- Linear Post-Regulators for SMPS
- Pagers

### Typical Application Circuit

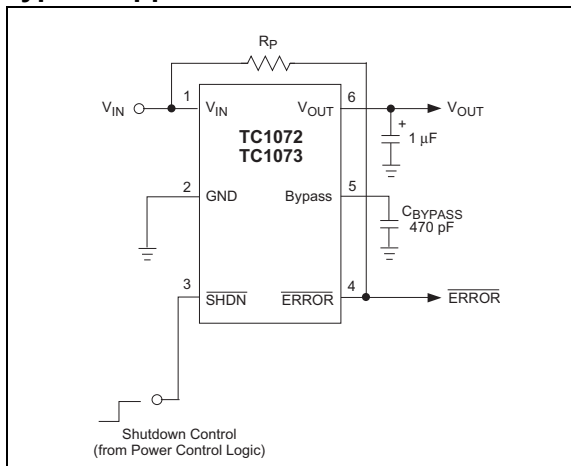

### General Description

The TC1072 and TC1073 are high accuracy (typically  $\pm 0.5\%$ ) CMOS upgrades for older (bipolar) low dropout regulators. Designed specifically for battery-operated systems, the devices' CMOS construction eliminates wasted ground current, significantly extending battery life. Total supply current is typically 50  $\mu\text{A}$  at full load (20 to 60 times lower than in bipolar regulators).

The devices' key features include ultra low noise operation (plus optional Bypass input); very low dropout voltage (typically 85 mV, TC1072 and 180 mV, TC1073 at full load) and fast response to step changes in load. An error output ( $\overline{\text{ERROR}}$ ) is asserted when the devices are out-of-regulation (due to a low input voltage or excessive output current).  $\overline{\text{ERROR}}$  can be used as a low battery warning or as a processor RESET signal (with the addition of an external RC network). Supply current is reduced to 0.5  $\mu\text{A}$  (max) and both  $V_{\text{OUT}}$  and  $\overline{\text{ERROR}}$  are disabled when the shutdown input is low. The devices incorporate both overtemperature and overcurrent protection.

The TC1072 and TC1073 are stable with an output capacitor of only 1  $\mu\text{F}$  and have a maximum output current of 50 mA, and 100 mA, respectively. For higher output current versions, please see the TC1185, TC1186, TC1187 ( $I_{\text{OUT}} = 150 \text{ mA}$ ) and TC1107, TC1108 and TC1173 ( $I_{\text{OUT}} = 300 \text{ mA}$ ) data sheets.

### Package Type

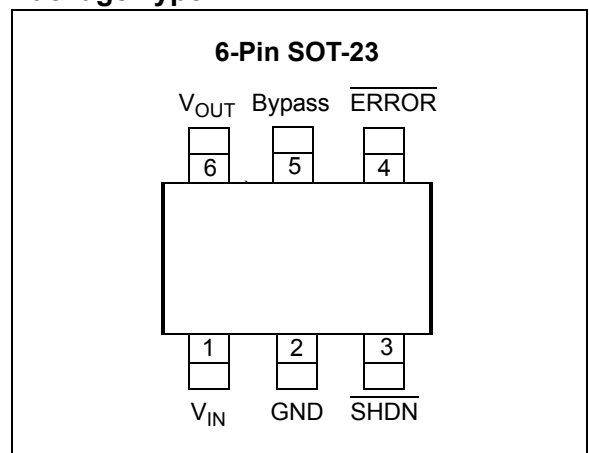

# TC1072/TC1073

## 1.0 ELECTRICAL CHARACTERISTICS

### Absolute Maximum Ratings†

Input Voltage .....	6.5V
Output Voltage.....	(-0.3V) to (V <sub>IN</sub> + 0.3V)
Power Dissipation.....	Internally Limited ( <b>Note 6</b> )
Maximum Voltage on Any Pin .....	V <sub>IN</sub> + 0.3V to -0.3V
Operating Temperature Range.....	-40°C < T <sub>J</sub> < 125°C
Storage Temperature.....	-65°C to +150°C

† **Note:** Stresses above those listed under "Absolute Maximum Ratings" may cause permanent damage to the device. These are stress ratings only and functional operation of the device at these or any other conditions above those indicated in the operation sections of the specifications is not implied. Exposure to Absolute Maximum Rating conditions for extended periods may affect device reliability.

## TC1072/TC1073 ELECTRICAL SPECIFICATIONS

<b>Electrical Characteristics:</b> Unless otherwise noted, V <sub>IN</sub> = V <sub>OUT</sub> + 1V, I <sub>L</sub> = 0.1 mA, C <sub>L</sub> = 3.3 μF, $\overline{\text{SHDN}} > V_{IH}$ , T <sub>A</sub> = +25°C. <b>Boldface</b> type specifications apply for junction temperatures of -40°C to +125°C.						
Symbol	Parameter	Min	Typ	Max	Units	Test Conditions
V <sub>IN</sub>	Input Operating Voltage	<b>2.7</b>	—	<b>6.0</b>	V	<b>Note 9</b>
I <sub>OUTMAX</sub>	Maximum Output Current	<b>50</b> <b>100</b>	—	—	mA mA	TC1072 TC1073
V <sub>OUT</sub>	Output Voltage	<b>V<sub>R</sub> - 2.5%</b>	V <sub>R</sub> ±0.5%	<b>V<sub>R</sub> + 2.5%</b>	V	<b>Note 1</b>
TCV <sub>OUT</sub>	V <sub>OUT</sub> Temperature Coefficient	—	20 40	—	ppm/°C	<b>Note 2</b>
ΔV <sub>OUT</sub> /ΔV <sub>IN</sub>	Line Regulation	—	0.05	<b>0.35</b>	%	(V <sub>R</sub> + 1V) ≤ V <sub>IN</sub> ≤ 6V
ΔV <sub>OUT</sub> /V <sub>OUT</sub>	Load Regulation	—	0.5	<b>2.0</b>	%	I <sub>L</sub> = 0.1 mA to I <sub>OUTMAX</sub> <b>(Note 3)</b>
V <sub>IN</sub> -V <sub>OUT</sub>	Dropout Voltage	—	2 65 85 180	— — <b>120</b> <b>250</b>	mV	I <sub>L</sub> = 0.1 mA I <sub>L</sub> = 20 mA I <sub>L</sub> = 50 mA I <sub>L</sub> = 100 mA ( <b>Note 4</b> ), TC1073
I <sub>IN</sub>	Supply Current	—	50	<b>80</b>	μA	$\overline{\text{SHDN}} = V_{IH}$ , I <sub>L</sub> = 0 ( <b>Note 8</b> )
I <sub>INSD</sub>	Shutdown Supply Current	—	0.05	0.5	μA	$\overline{\text{SHDN}} = 0V$
PSRR	Power Supply Rejection Ratio	—	64	—	dB	F <sub>RE</sub> ≤ 1 kHz
I <sub>OUTSC</sub>	Output Short Circuit Current	—	300	450	mA	V <sub>OUT</sub> = 0V
ΔV <sub>OUT</sub> /ΔP <sub>D</sub>	Thermal Regulation	—	0.04	—	V/W	<b>Notes 5, 6</b>
T <sub>SD</sub>	Thermal Shutdown Die Temperature	—	160	—	°C	
ΔT <sub>SD</sub>	Thermal Shutdown Hysteresis	—	10	—	°C	
eN	Output Noise	—	260	—	nV/√Hz	I <sub>L</sub> = I <sub>OUTMAX</sub> 470 pF from Bypass to GND

- Note 1:** V<sub>R</sub> is the regulator output voltage setting. For example: V<sub>R</sub> = 2.5V, 2.7V, 2.85V, 3.0V, 3.3V, 3.6V, 4.0V, 5.0V.  
**Note 2:**  $TC V_{OUT} = \frac{(V_{OUTMAX} - V_{OUTMIN}) \times 10^6}{V_{OUT} \times \Delta T}$   
**Note 3:** Regulation is measured at a constant junction temperature using low duty cycle pulse testing. Load regulation is tested over a load range from 0.1 mA to the maximum specified output current. Changes in output voltage due to heating effects are covered by the thermal regulation specification.  
**Note 4:** Dropout voltage is defined as the input to output differential at which the output voltage drops 2% below its nominal value.  
**Note 5:** Thermal Regulation is defined as the change in output voltage at a time T after a change in power dissipation is applied, excluding load or line regulation effects. Specifications are for a current pulse equal to I<sub>LMAX</sub> at V<sub>IN</sub> = 6V for T = 10 ms.  
**Note 6:** The maximum allowable power dissipation is a function of ambient temperature, the maximum allowable junction temperature and the thermal resistance from junction-to-air (i.e., T<sub>A</sub>, T<sub>J</sub>, θ<sub>JA</sub>). Exceeding the maximum allowable power dissipation causes the device to initiate thermal shutdown. Please see **Section 5.0 "Thermal Considerations"** for more details.  
**Note 7:** Hysteresis voltage is referenced by V<sub>R</sub>.  
**Note 8:** Apply for Junction Temperatures of -40°C to +85°C.  
**Note 9:** The minimum V<sub>IN</sub> has to justify the conditions = V<sub>IN</sub> ≥ V<sub>R</sub> + V<sub>DROPOUT</sub> and V<sub>IN</sub> ≥ 2.7V for I<sub>L</sub> = 0.1 mA to I<sub>OUTMAX</sub>.

## TC1072/TC1073 ELECTRICAL SPECIFICATIONS (CONTINUED)

<b>Electrical Characteristics:</b> Unless otherwise noted, $V_{IN} = V_{OUT} + 1V$ , $I_L = 0.1\text{ mA}$ , $C_L = 3.3\text{ }\mu\text{F}$ , $\overline{\text{SHDN}} > V_{IH}$ , $T_A = +25^\circ\text{C}$ . <b>Boldface</b> type specifications apply for junction temperatures of $-40^\circ\text{C}$ to $+125^\circ\text{C}$ .						
Symbol	Parameter	Min	Typ	Max	Units	Test Conditions
<b>SHDN Input</b>						
$V_{IH}$	$\overline{\text{SHDN}}$ Input High Threshold	45	—	—	$\%V_{IN}$	$V_{IN} = 2.5\text{V to }6.5\text{V}$
$V_{IL}$	$\overline{\text{SHDN}}$ Input Low Threshold	—	—	15	$\%V_{IN}$	$V_{IN} = 2.5\text{V to }6.5\text{V}$
<b>ERROR Open Drain Output</b>						
$V_{INMIN}$	Minimum $V_{IN}$ Operating Voltage	1.0	—	—	V	
$V_{OL}$	Output Logic Low Voltage	—	—	400	mV	1 mA Flows to $\overline{\text{ERROR}}$
$V_{TH}$	$\overline{\text{ERROR}}$ Threshold Voltage	—	$0.95 \times V_R$	—	V	See <a href="#">Figure 4-2</a>
$V_{HYS}$	$\overline{\text{ERROR}}$ Positive Hysteresis	—	50	—	mV	<b>Note 7</b>
$t_{DELAY}$	$V_{OUT}$ to $\overline{\text{ERROR}}$ Delay	—	2.5	—	ms	$V_{out}$ falling from $V_R$ to $V_R - 10\%$

**Note 1:**  $V_R$  is the regulator output voltage setting. For example:  $V_R = 2.5\text{V}, 2.7\text{V}, 2.85\text{V}, 3.0\text{V}, 3.3\text{V}, 3.6\text{V}, 4.0\text{V}, 5.0\text{V}$ .

**Note 2:**  $TC\ V_{OUT} = \frac{(V_{OUTMAX} - V_{OUTMIN}) \times 10^6}{V_{OUT} \times \Delta T}$

- Note 3:** Regulation is measured at a constant junction temperature using low duty cycle pulse testing. Load regulation is tested over a load range from 0.1 mA to the maximum specified output current. Changes in output voltage due to heating effects are covered by the thermal regulation specification.
- Note 4:** Dropout voltage is defined as the input to output differential at which the output voltage drops 2% below its nominal value.
- Note 5:** Thermal Regulation is defined as the change in output voltage at a time T after a change in power dissipation is applied, excluding load or line regulation effects. Specifications are for a current pulse equal to  $I_{LMAX}$  at  $V_{IN} = 6\text{V}$  for  $T = 10\text{ ms}$ .
- Note 6:** The maximum allowable power dissipation is a function of ambient temperature, the maximum allowable junction temperature and the thermal resistance from junction-to-air (i.e.,  $T_A, T_J, \theta_{JA}$ ). Exceeding the maximum allowable power dissipation causes the device to initiate thermal shutdown. Please see **Section 5.0 "Thermal Considerations"** for more details.
- Note 7:** Hysteresis voltage is referenced by  $V_R$ .
- Note 8:** Apply for Junction Temperatures of  $-40^\circ\text{C}$  to  $+85^\circ\text{C}$ .
- Note 9:** The minimum  $V_{IN}$  has to justify the conditions =  $V_{IN} \geq V_R + V_{DROPOUT}$  and  $V_{IN} \geq 2.7\text{V}$  for  $I_L = 0.1\text{ mA}$  to  $I_{OUTMAX}$ .

# TC1072/TC1073

## 2.0 TYPICAL CHARACTERISTICS CURVES

**Note:** The graphs and tables provided following this note are a statistical summary based on a limited number of samples and are provided for informational purposes only. The performance characteristics listed herein are not tested or guaranteed. In some graphs or tables, the data presented may be outside the specified operating range (e.g., outside specified power supply range) and therefore outside the warranted range.

**Note:** Unless otherwise specified, all parts are measured at temperature = +25°C.

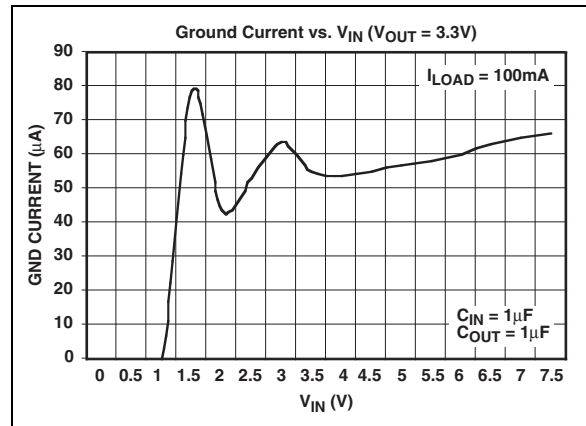
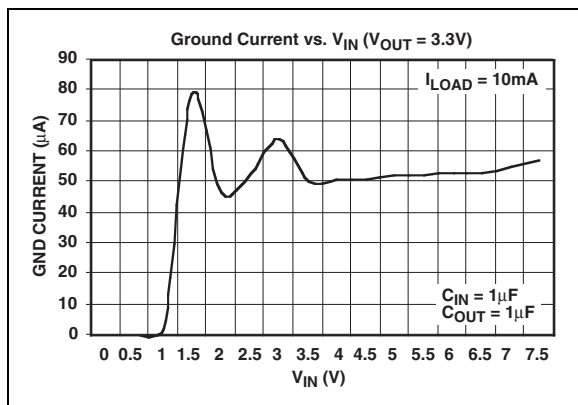
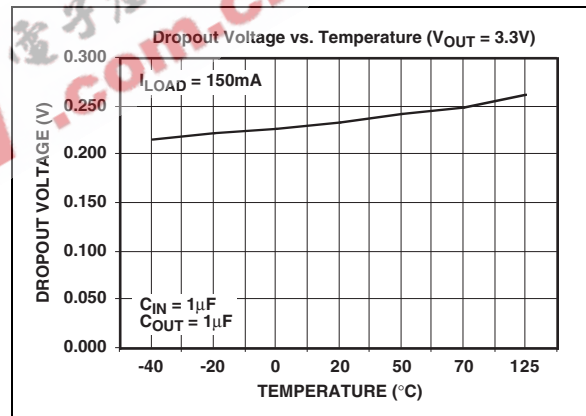
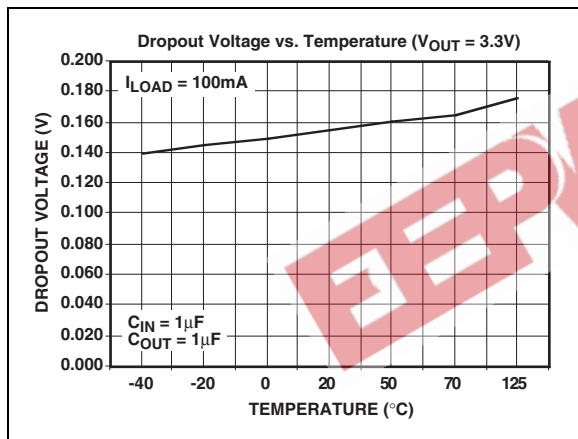
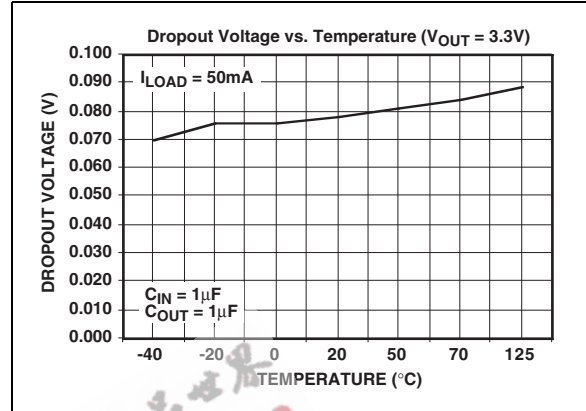
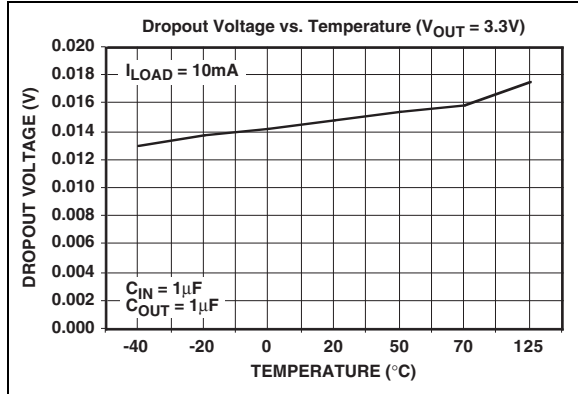

# TC1072/TC1073

**Note:** Unless otherwise specified, all parts are measured at temperature = +25°C.

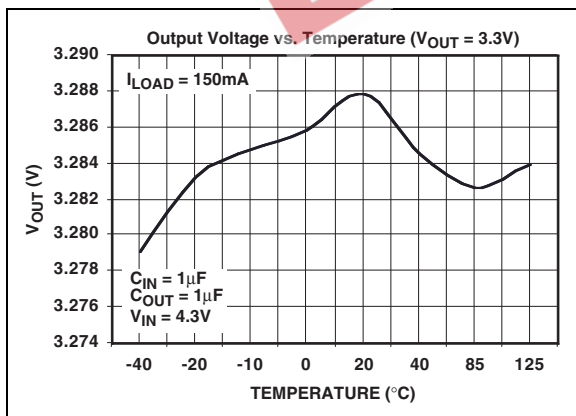
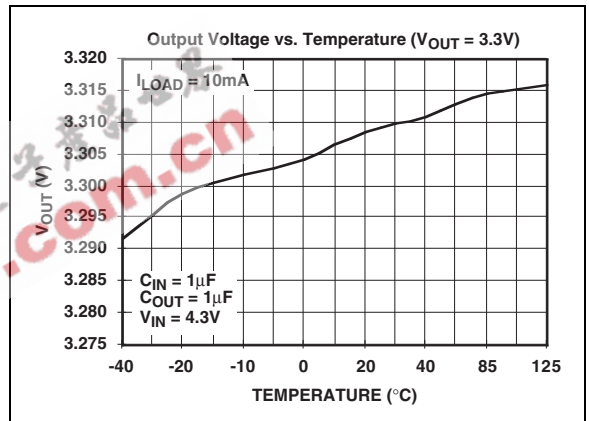
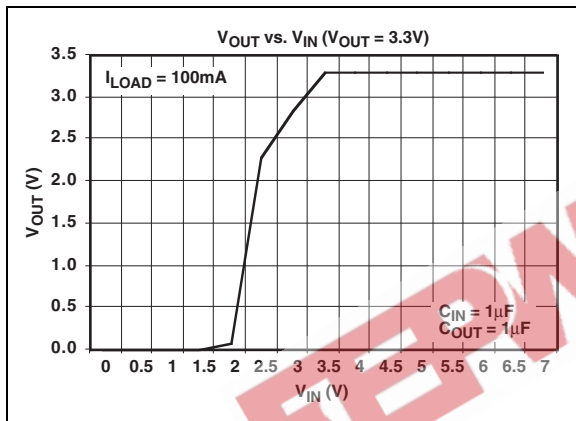
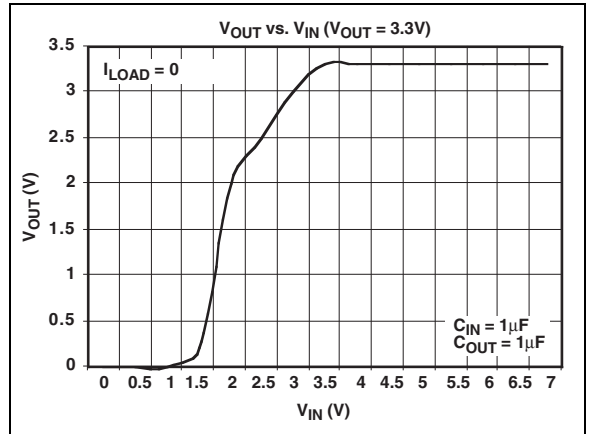
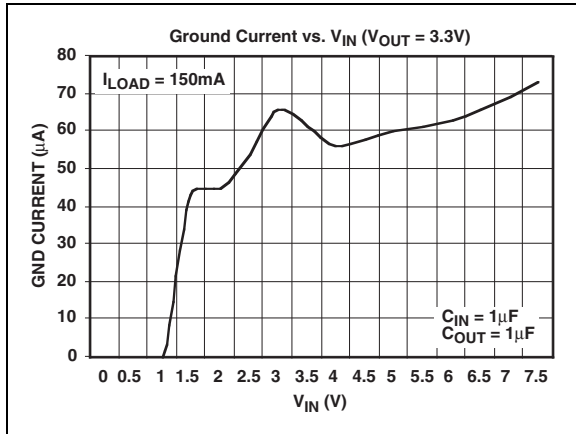

# TC1072/TC1073

**Note:** Unless otherwise specified, all parts are measured at temperature = +25°C.

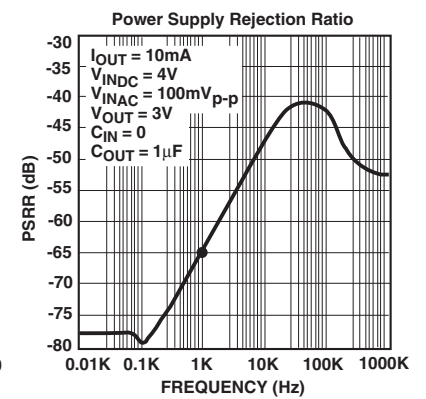
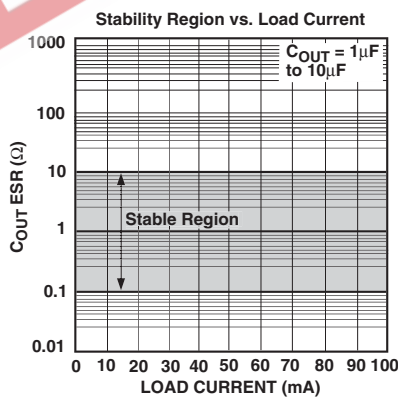
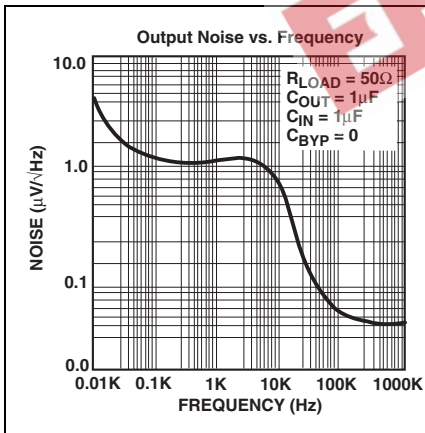
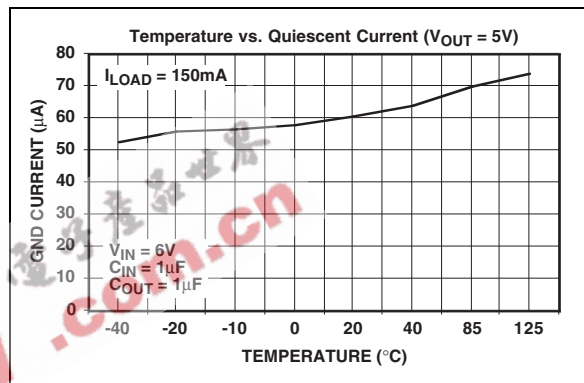
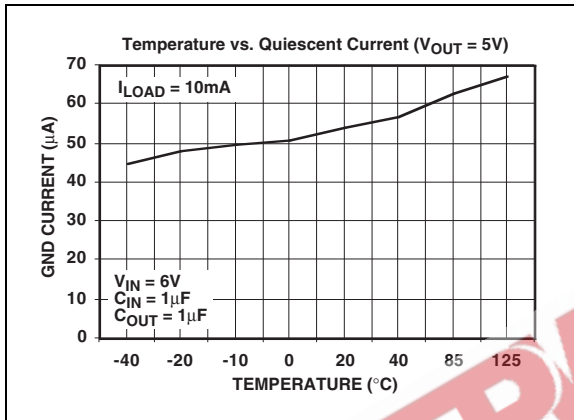
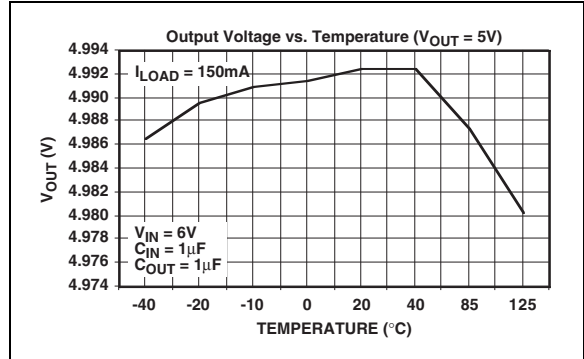
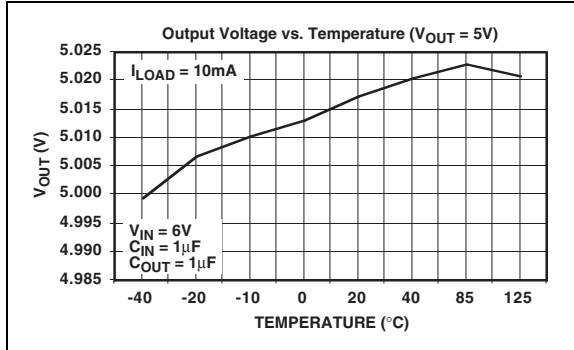

# TC1072/TC1073

**Note:** Unless otherwise specified, all parts are measured at temperature = +25°C.

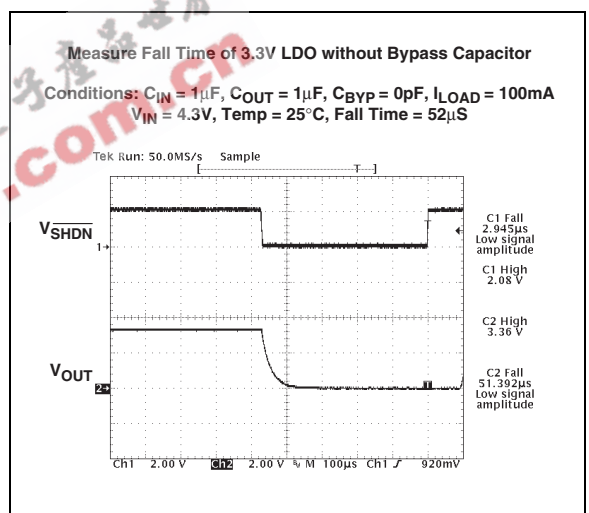
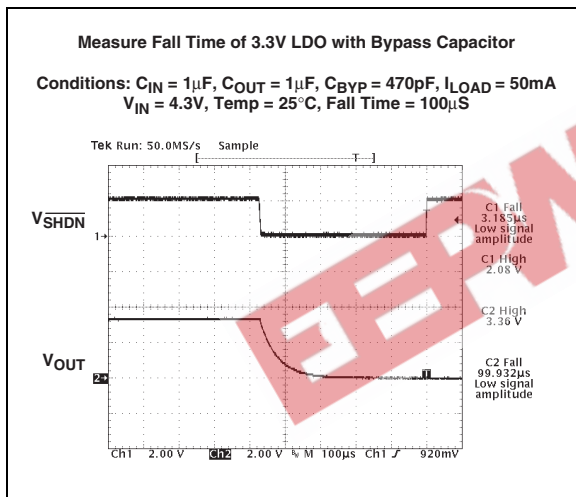
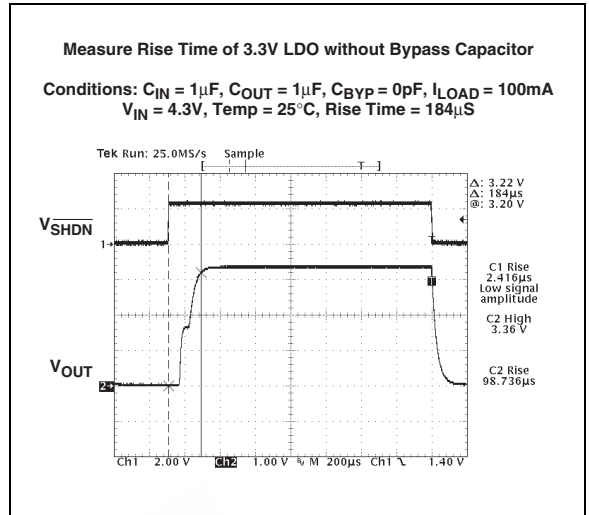
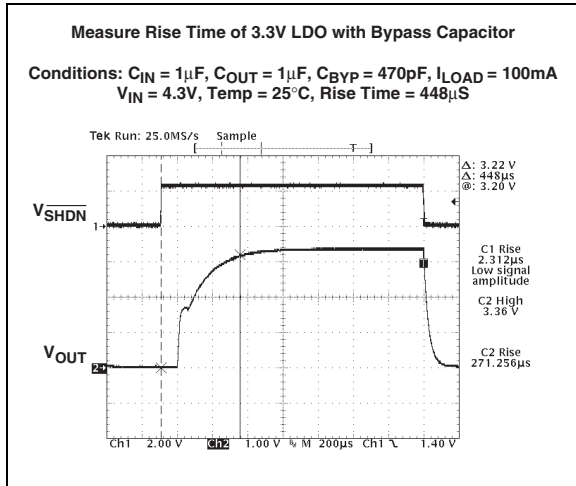

# TC1072/TC1073

**Note:** Unless otherwise specified, all parts are measured at temperature = +25°C.

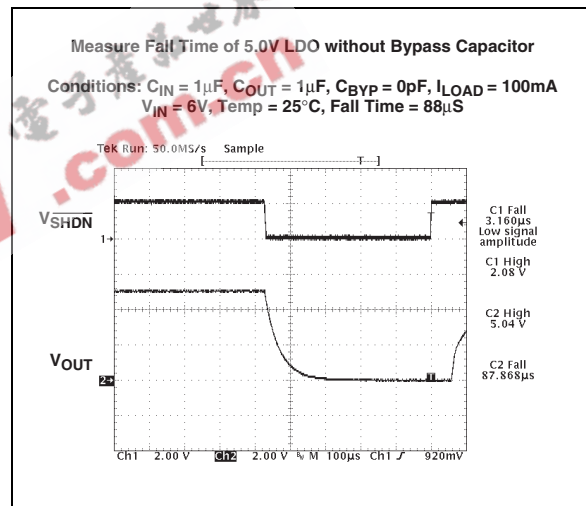
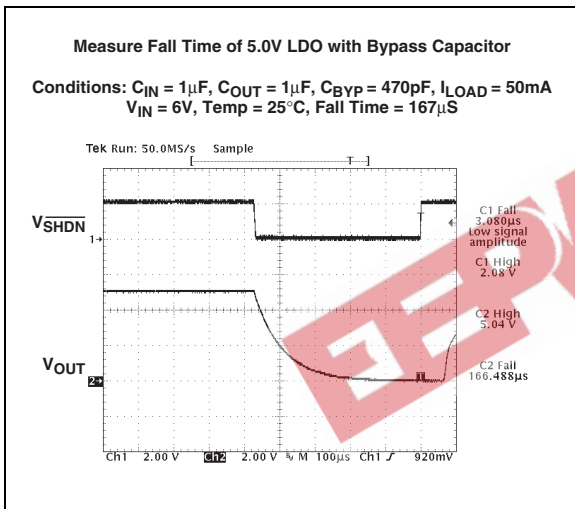
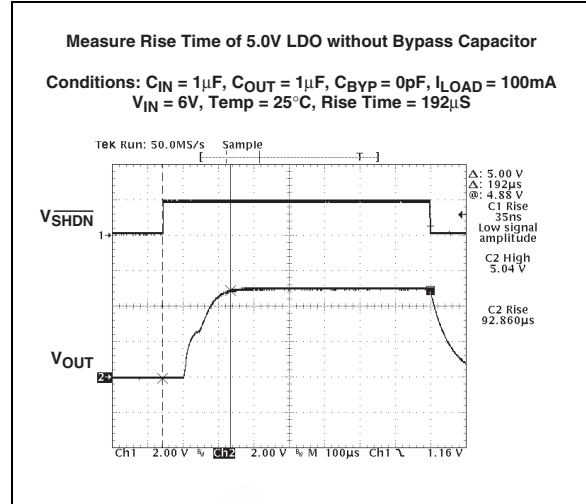
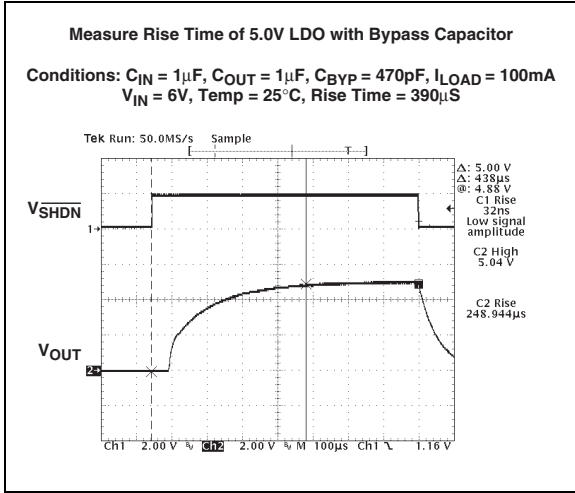



# TC1072/TC1073

**Note:** Unless otherwise specified, all parts are measured at temperature = +25°C.

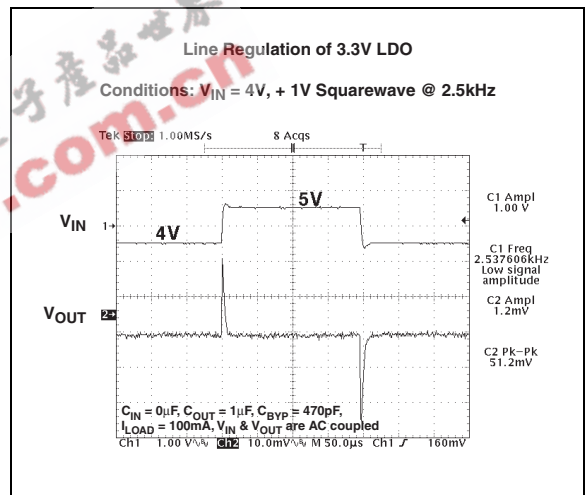
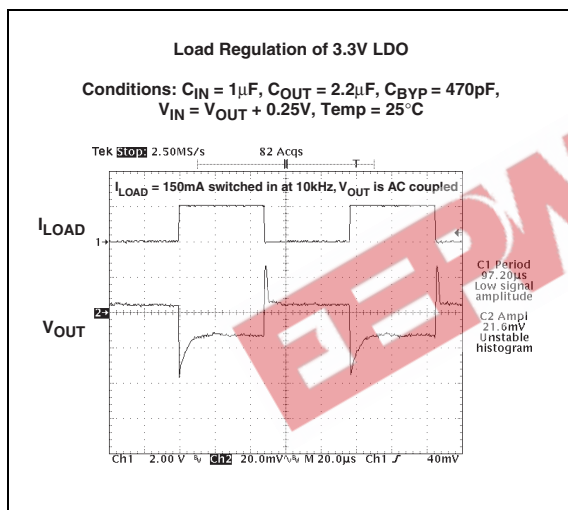
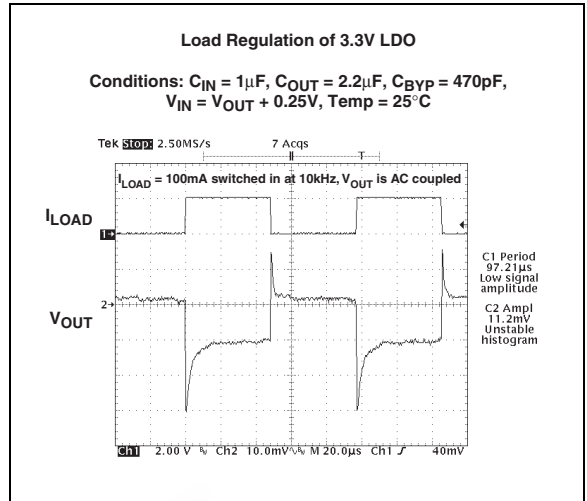
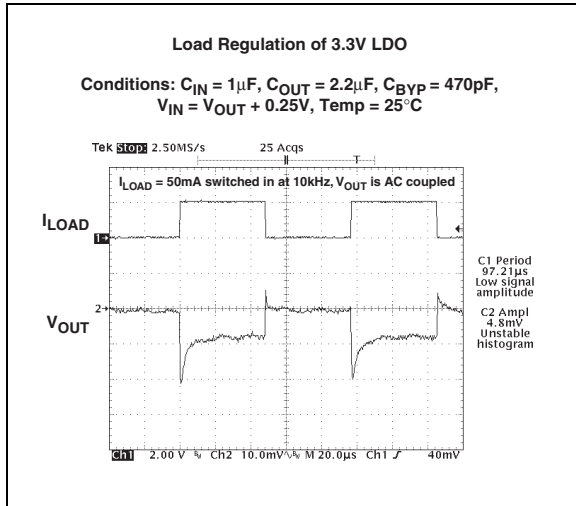

# TC1072/TC1073

**Note:** Unless otherwise specified, all parts are measured at temperature = +25°C.

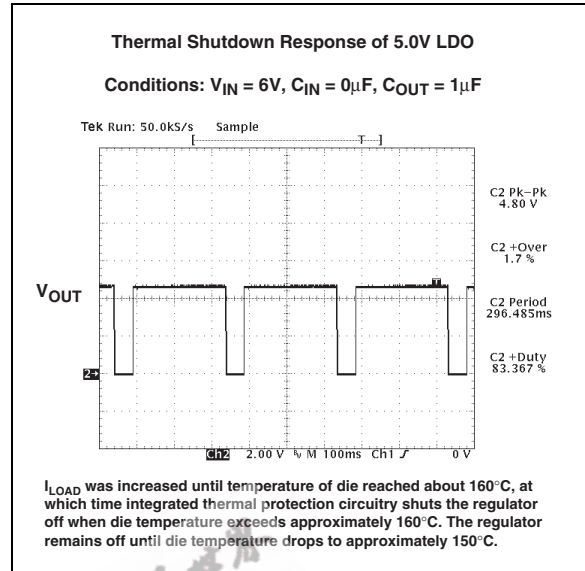
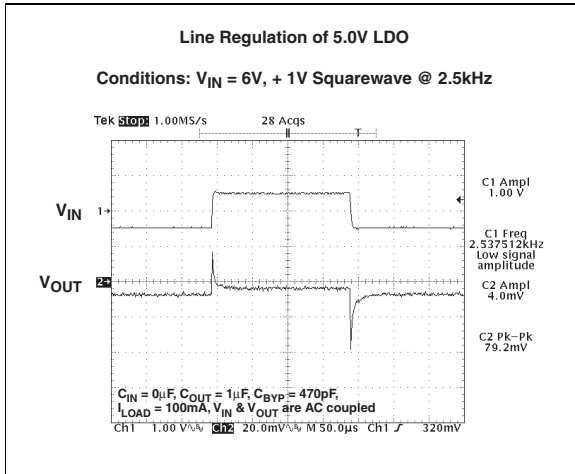

## 3.0 PIN DESCRIPTIONS

The descriptions of the pins are listed in [Table 3-1](#).

**TABLE 3-1: PIN FUNCTION TABLE**

Pin No. (6-Pin SOT-23)	Symbol	Description
1	$V_{IN}$	Unregulated supply input.
2	GND	Ground terminal.
3	$\overline{\text{SHDN}}$	Shutdown control input.
4	$\overline{\text{ERROR}}$	Out-of-Regulation Flag. (Open drain output).
5	Bypass	Reference bypass input.
6	$V_{OUT}$	Regulated voltage output.

### 3.1 Input Voltage Supply ( $V_{IN}$ )

Connect unregulated input supply to the  $V_{IN}$  pin. If there is a large distance between the input supply and the LDO regulator, some input capacitance is necessary for proper operation. A 1  $\mu\text{F}$  capacitor connected from  $V_{IN}$  to ground is recommended for most applications.

### 3.2 Ground (GND)

Connect the unregulated input supply ground return to GND. Also connect the negative side of the 1  $\mu\text{F}$  typical input decoupling capacitor close to GND and the negative side of the output capacitor  $C_{OUT}$  to GND.

### 3.3 Shutdown Control Input ( $\overline{\text{SHDN}}$ )

The regulator is fully enabled when a logic-high is applied to  $\overline{\text{SHDN}}$ . The regulator enters shutdown when a logic-low is applied to  $\overline{\text{SHDN}}$ . During shutdown, output voltage falls to zero,  $\overline{\text{ERROR}}$  is open-circuited and supply current is reduced to 0.5  $\mu\text{A}$  (maximum).

### 3.4 Out-Of-Regulation Flag ( $\overline{\text{ERROR}}$ )

$\overline{\text{ERROR}}$  goes low when  $V_{OUT}$  is out-of-tolerance by approximately – 5%.

### 3.5 Reference Bypass Input (Bypass)

Connecting a 470 pF to this input further reduces output noise.

### 3.6 Regulated Voltage Output ( $V_{OUT}$ )

Connect the output load to  $V_{OUT}$  of the LDO. Also connect the positive side of the LDO output capacitor as close as possible to the  $V_{OUT}$  pin.

# TC1072/TC1073

## 4.0 DETAILED DESCRIPTION

The TC1072 and TC1073 are precision fixed output voltage regulators. (If an adjustable version is desired, please see the TC1070/TC1071/TC1187 data sheet.) Unlike bipolar regulators, the TC1072 and TC1073's supply current does not increase with load current. In addition,  $V_{OUT}$  remains stable and within regulation over the entire 0 mA to  $I_{OUTMAX}$  load current range, (an important consideration in RTC and CMOS RAM battery back-up applications).

Figure 4-1 shows a typical application circuit. The regulator is enabled any time the shutdown input (SHDN) is at or above  $V_{IH}$ , and shutdown (disabled) when SHDN is at or below  $V_{IL}$ . SHDN may be controlled by a CMOS logic gate, or I/O port of a microcontroller. If the SHDN input is not required, it should be connected directly to the input supply. While in shutdown, supply current decreases to 0.05  $\mu$ A (typical),  $V_{OUT}$  falls to zero volts, and ERROR is open-circuited.

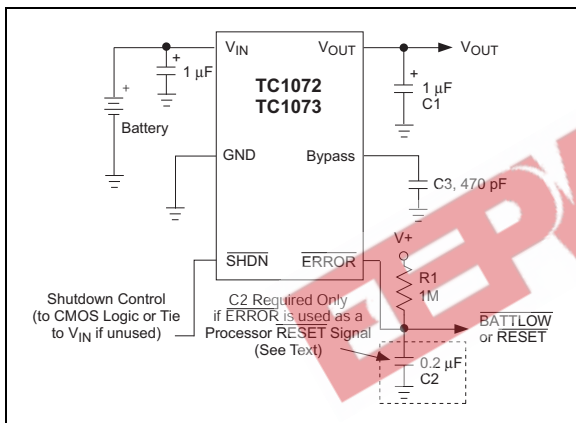

FIGURE 4-1: Typical Application Circuit.

### 4.1 ERROR Open-Drain Output

ERROR is driven low whenever  $V_{OUT}$  falls out of regulation by more than -5% (typical). This condition may be caused by low input voltage, output current limiting, or thermal limiting. The ERROR output voltage value (e.g.  $\overline{ERROR} = V_{OL}$  at 4.75V (typical) for a 5.0V regulator and 2.85V (typical) for a 3.0V regulator). ERROR output operation is shown in Figure 4-2.

Note that  $\overline{ERROR}$  is active tDELAY (typically, 2.5  $\mu$ s) after  $V_{OUT}$  falls to  $V_{TH}$ , and inactive when  $V_{OUT}$  rises above  $V_{TH}$  by  $V_{HYS}$ .

As shown in Figure 4-1,  $\overline{ERROR}$  can be used as a battery low flag, or as a processor RESET signal (with the addition of timing capacitor  $C_2$ ).  $R_1 \times C_2$  should be chosen to maintain ERROR below  $V_{IH}$  of the processor RESET input for at least 200 ms to allow time for the system to stabilize. Pull-up resistor  $R_1$  can be tied to  $V_{OUT}$ ,  $V_{IN}$  or any other voltage less than  $(V_{IN} + 0.3V)$ .

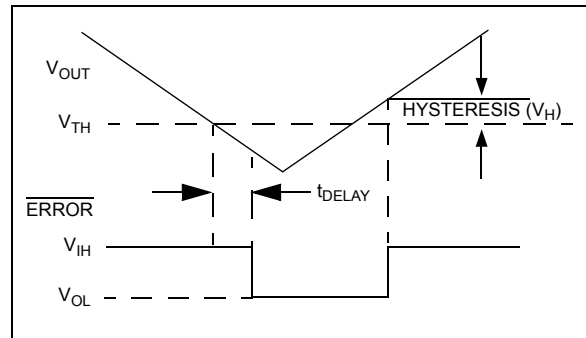

FIGURE 4-2: Error Output Operation.

### 4.2 Output Capacitor

A 1  $\mu$ F (minimum) capacitor from  $V_{OUT}$  to ground is recommended. The output capacitor should have an effective series resistance greater than 0.1 $\Omega$  and less than 5.0 $\Omega$ , and a resonant frequency above 1 MHz. A 1  $\mu$ F capacitor should be connected from  $V_{IN}$  to GND if there is more than 10 inches of wire between the regulator and the AC filter capacitor, or if a battery is used as the power source. Aluminum electrolytic or tantalum capacitor types can be used. (Since many aluminum electrolytic capacitors freeze at approximately -30°C, solid tantalums are recommended for applications operating below -25°C.) When operating from sources other than batteries, supply-noise rejection and transient response can be improved by increasing the value of the input and output capacitors and employing passive filtering techniques.

### 4.3 Bypass Input

A 470 pF capacitor connected from the Bypass input to ground reduces noise present on the internal reference, which in turn significantly reduces output noise. If output noise is not a concern, this input may be left unconnected. Larger capacitor values may be used, but results in a longer time period to rated output voltage when power is initially applied.

## 5.0 THERMAL CONSIDERATIONS

### 5.1 Thermal Shutdown

Integrated thermal protection circuitry shuts the regulator off when die temperature exceeds 160°C. The regulator remains off until the die temperature drops to approximately 150°C.

### 5.2 Power Dissipation

The amount of power the regulator dissipates is primarily a function of input and output voltage, and output current. The following equation is used to calculate worst-case *actual* power dissipation:

#### EQUATION 5-1:

$$P_D \approx (V_{INMAX} - V_{OUTMIN}) I_{LOADMAX}$$

Where:

$P_D$  = Worst-case actual power dissipation  
 $V_{INMAX}$  = Maximum voltage on  $V_{IN}$   
 $V_{OUTMIN}$  = Minimum regulator output voltage  
 $I_{LOADMAX}$  = Maximum output (load) current

The maximum *allowable* power dissipation (Equation 5-2) is a function of the maximum ambient temperature ( $T_{AMAX}$ ), the maximum allowable die temperature ( $T_{JMAX}$ ) and the thermal resistance from junction-to-air ( $\theta_{JA}$ ). The 6-Pin SOT-23 package has a  $\theta_{JA}$  of approximately 220°C/Watt.

#### EQUATION 5-2:

$$P_{DMAX} = \frac{(T_{JMAX} - T_{AMAX})}{\theta_{JA}}$$

where all terms are previously defined.

Equation 5-1 can be used in conjunction with Equation 5-2 to ensure regulator thermal operation is within limits. For example:

Given:

$$\begin{aligned} V_{INMAX} &= 3.0V \pm 5\% \\ V_{OUTMIN} &= 2.7V - 2.5\% \\ I_{LOADMAX} &= 40 \text{ mA} \\ T_{JMAX} &= 125^\circ\text{C} \\ T_{AMAX} &= 55^\circ\text{C} \end{aligned}$$

Find: 1. Actual power dissipation  
 2. Maximum allowable dissipation

Actual power dissipation:

$$\begin{aligned} P_D &\approx (V_{INMAX} - V_{OUTMIN}) I_{LOADMAX} \\ &= [(3.0 \times 1.05) - (2.7 \times 0.975)] \times 40 \times 10^{-3} \\ &= 20.7 \text{ mW} \end{aligned}$$

Maximum allowable power dissipation:

$$\begin{aligned} P_{DMAX} &= \frac{(T_{JMAX} - T_{AMAX})}{\theta_{JA}} \\ &= \frac{(125 - 55)}{220} \\ &= 318 \text{ mW} \end{aligned}$$

In this example, the TC1072 dissipates a maximum of 20.7 mW; below the allowable limit of 318 mW. In a similar manner, Equation 5-1 and Equation 5-2 can be used to calculate maximum current and/or input voltage limits.

### 5.3 Layout Considerations

The primary path of heat conduction out of the package is via the package leads. Therefore, layouts having a ground plane, wide traces at the pads, and wide power supply bus lines combine to lower  $\theta_{JA}$  and therefore increase the maximum allowable power dissipation limit.

# TC1072/TC1073

## 6.0 PACKAGING INFORMATION

### 6.1 Package Marking Information

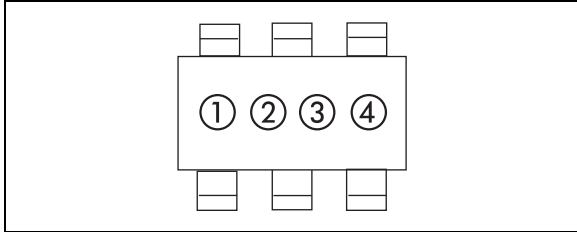

① & ② = part number code + threshold voltage (two-digit code)

(V)	TC1072 Code	TC1073 Code
1.8	EY	FY
2.5	E1	F1
2.6	ET	FT
2.7	E2	F2
2.8	EZ	FZ
2.85	E8	F8
3.0	E3	F3
3.3	E4	F4
3.6	E9	F9
4.0	E0	F0
5.0	E6	F6

③ represents year and quarter code

④ represents production lot ID code

### 6.2 Taping Form

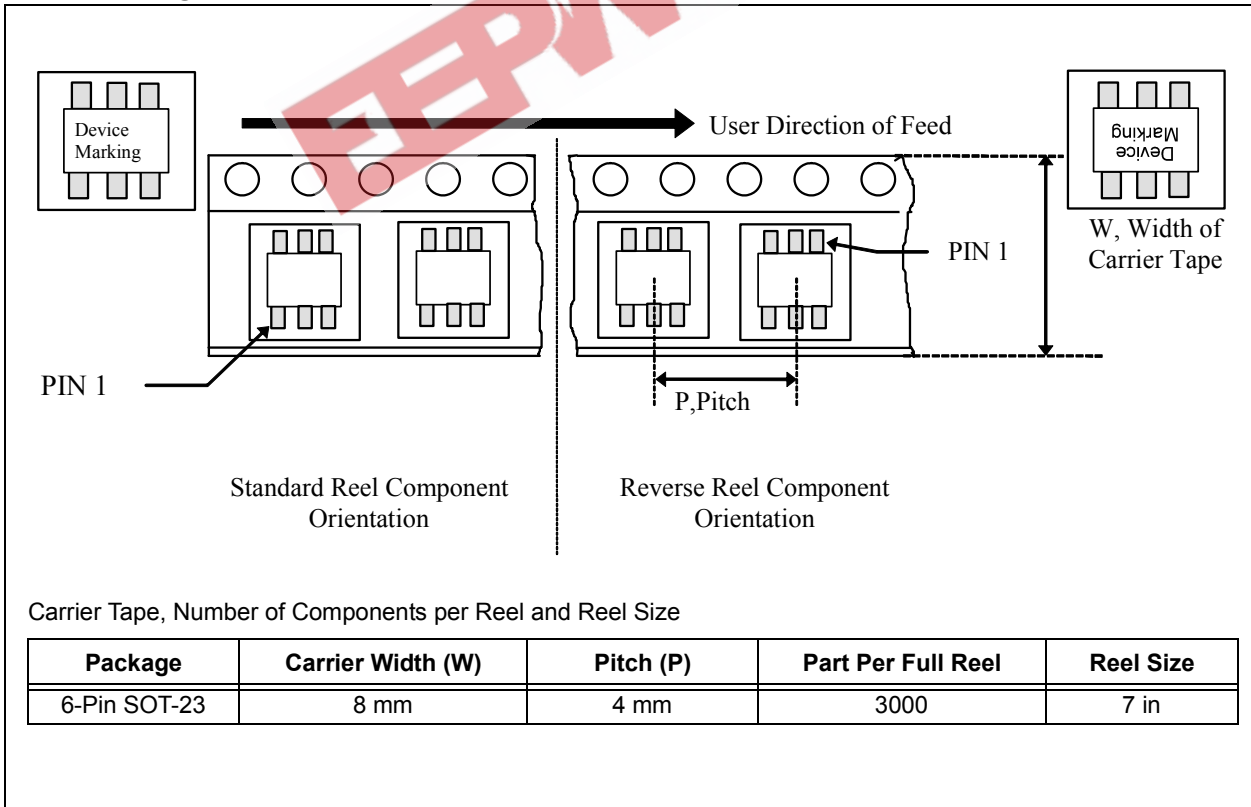

# TC1072/TC1073

## 6-Lead Plastic Small Outline Transistor (CH) [SOT-23]

**Note:** For the most current package drawings, please see the Microchip Packaging Specification located at <http://www.microchip.com/packaging>

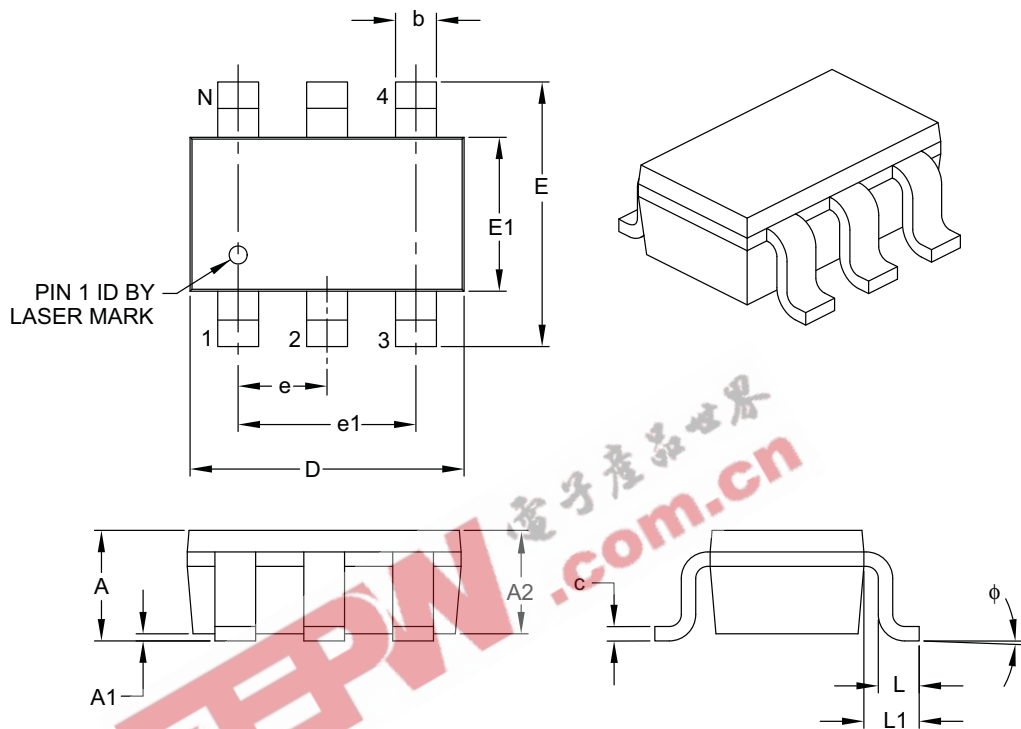

Dimension Limits	Units	MILLIMETERS		
		MIN	NOM	MAX
Number of Pins	N	6		
Pitch	e	0.95 BSC		
Outside Lead Pitch	e1	1.90 BSC		
Overall Height	A	0.90	–	1.45
Molded Package Thickness	A2	0.89	–	1.30
Standoff	A1	0.00	–	0.15
Overall Width	E	2.20	–	3.20
Molded Package Width	E1	1.30	–	1.80
Overall Length	D	2.70	–	3.10
Foot Length	L	0.10	–	0.60
Footprint	L1	0.35	–	0.80
Foot Angle	$\phi$	0°	–	30°
Lead Thickness	c	0.08	–	0.26
Lead Width	b	0.20	–	0.51

**Notes:**

- Dimensions D and E1 do not include mold flash or protrusions. Mold flash or protrusions shall not exceed 0.127 mm per side.
- Dimensioning and tolerancing per ASME Y14.5M.  
BSC: Basic Dimension. Theoretically exact value shown without tolerances.

Microchip Technology Drawing C04-028B

# TC1072/TC1073

---

NOTES:

EEPW 电子产品世界  
.com.cn



## APPENDIX A: REVISION HISTORY

### Revision D (February 2007)

- **Page 1:** Ground current changed to 50  $\mu$ A.
- Package type changed from SOT-23A to SOT-23.
- Added voltage options.
- $T_{\text{DELAY}}$  added to Table 1-1.
- **Section 3.0 “Pin Descriptions”:** Added pin descriptions.
- **Section 4.1 “ERROR Open-Drain Output”:** Defined  $t_{\text{DELAY}}$ .
- Changed Figure 4-2.
- Updated Packaging Information.

### Revision C (January 2006)

- Undocumented changes.

### Revision B (May 2002)

- Undocumented changes.

### Revision A (March 2002)

- Original Release of this Document.

EEPW 电子产品世界  
.com.cn

# TC1072/TC1073

---

NOTES:

EEPW 电子产品世界  
.com.cn

# TC1072/TC1073

## PRODUCT IDENTIFICATION SYSTEM

To order or obtain information, e.g., on pricing or delivery, refer to the factory or the listed sales office.

<u>PART NO.</u>	—	<u>X,X</u>		<u>X</u>		<u>XXXXX</u>
Device		Threshold Voltage		Temperature Range		Package
Device		TC1072: CMOS LDO with Shutdown, $\overline{\text{ERROR}}$ Output & $V_{\text{REF}}$ Bypass				
		TC1073: CMOS LDO with Shutdown, $\overline{\text{ERROR}}$ Output & $V_{\text{REF}}$ Bypass				
Threshold voltage (typical)		1.8 = 1.8V				
		2.5 = 2.5V				
		2.6 = 2.6V				
		2.7 = 2.7V				
		2.8 = 2.8V				
		2.85 = 2.85V				
		3.0 = 3.0V				
		3.3 = 3.3V				
		3.6 = 3.6V				
		4.0 = 4.0V				
		5.0 = 5.0V				
Temperature Range	V			-40° C to +125° C		
Package		CH713 =		Plastic small outline transistor (CH) SOT-23, 6 lead, (tape and reel).		

Examples:	
a)	TC1072-1.8VCH713: 1.8V
b)	TC1072-2.5VCH713 2.5V
c)	TC1072-2.6VCH713 2.6V
d)	TC1072-2.7VCH713 2.7V
e)	TC1072-2.8VCH713 2.8V
f)	TC1072-2.85VCH713 2.85V
g)	TC1072-3.0VCH713 3.0V
h)	TC1072-3.3VCH713 3.3V
i)	TC1072-3.6VCH713 3.6V
j)	TC1072-4.0VCH713 4.0V
k)	TC1072-5.0VCH713 5.0V
a)	TC1073-1.8VCH713: 1.8V
b)	TC1073-2.5VCH713 2.5V
c)	TC1073-2.6VCH713 2.6V
d)	TC1073-2.7VCH713 2.7V
e)	TC1073-2.8VCH713 2.8V
f)	TC1073-2.85VCH713 2.85V
g)	TC1073-3.0VCH713 3.0V
h)	TC1073-3.3VCH713 3.3V
i)	TC1073-3.6VCH713 3.6V
j)	TC1073-4.0VCH713 4.0V
k)	TC1073-5.0VCH713 5.0V

# TC1072/TC1073

---

NOTES:

EEPW 电子产品世界  
.com.cn

---

---

**Note the following details of the code protection feature on Microchip devices:**

- Microchip products meet the specification contained in their particular Microchip Data Sheet.
- Microchip believes that its family of products is one of the most secure families of its kind on the market today, when used in the intended manner and under normal conditions.
- There are dishonest and possibly illegal methods used to breach the code protection feature. All of these methods, to our knowledge, require using the Microchip products in a manner outside the operating specifications contained in Microchip's Data Sheets. Most likely, the person doing so is engaged in theft of intellectual property.
- Microchip is willing to work with the customer who is concerned about the integrity of their code.
- Neither Microchip nor any other semiconductor manufacturer can guarantee the security of their code. Code protection does not mean that we are guaranteeing the product as "unbreakable."

Code protection is constantly evolving. We at Microchip are committed to continuously improving the code protection features of our products. Attempts to break Microchip's code protection feature may be a violation of the Digital Millennium Copyright Act. If such acts allow unauthorized access to your software or other copyrighted work, you may have a right to sue for relief under that Act.

---

Information contained in this publication regarding device applications and the like is provided only for your convenience and may be superseded by updates. It is your responsibility to ensure that your application meets with your specifications. MICROCHIP MAKES NO REPRESENTATIONS OR WARRANTIES OF ANY KIND WHETHER EXPRESS OR IMPLIED, WRITTEN OR ORAL, STATUTORY OR OTHERWISE, RELATED TO THE INFORMATION, INCLUDING BUT NOT LIMITED TO ITS CONDITION, QUALITY, PERFORMANCE, MERCHANTABILITY OR FITNESS FOR PURPOSE. Microchip disclaims all liability arising from this information and its use. Use of Microchip devices in life support and/or safety applications is entirely at the buyer's risk, and the buyer agrees to defend, indemnify and hold harmless Microchip from any and all damages, claims, suits, or expenses resulting from such use. No licenses are conveyed, implicitly or otherwise, under any Microchip intellectual property rights.

**Trademarks**

The Microchip name and logo, the Microchip logo, Accuron, dsPIC, KEELOQ, KEELOQ logo, microID, MPLAB, PIC, PICmicro, PICSTART, PRO MATE, PowerSmart, rPIC, and SmartShunt are registered trademarks of Microchip Technology Incorporated in the U.S.A. and other countries.

AmpLab, FilterLab, Linear Active Thermistor, Migratable Memory, MXDEV, MXLAB, PS logo, SEEVAL, SmartSensor and The Embedded Control Solutions Company are registered trademarks of Microchip Technology Incorporated in the U.S.A.

Analog-for-the-Digital Age, Application Maestro, CodeGuard, dsPICDEM, dsPICDEM.net, dsPICworks, ECAN, ECONOMONITOR, FanSense, FlexROM, fuzzyLAB, In-Circuit Serial Programming, ICSP, ICEPIC, Mindi, MiWi, MPASM, MPLAB Certified logo, MPLIB, MPLINK, PICKit, PICDEM, PICDEM.net, PICLAB, PICtail, PowerCal, PowerInfo, PowerMate, PowerTool, REAL ICE, rLAB, rPICDEM, Select Mode, Smart Serial, SmartTel, Total Endurance, UNI/O, WiperLock and ZENA are trademarks of Microchip Technology Incorporated in the U.S.A. and other countries.

SQTP is a service mark of Microchip Technology Incorporated in the U.S.A.

All other trademarks mentioned herein are property of their respective companies.

© 2007, Microchip Technology Incorporated, Printed in the U.S.A., All Rights Reserved.

 Printed on recycled paper.

**QUALITY MANAGEMENT SYSTEM  
CERTIFIED BY DNV  
== ISO/TS 16949:2002 ==**

*Microchip received ISO/TS-16949:2002 certification for its worldwide headquarters, design and wafer fabrication facilities in Chandler and Tempe, Arizona, Gresham, Oregon and Mountain View, California. The Company's quality system processes and procedures are for its PIC<sup>®</sup> MCUs and dsPIC<sup>®</sup> DSCs, KEELOQ<sup>®</sup> code hopping devices, Serial EEPROMs, microperipherals, nonvolatile memory and analog products. In addition, Microchip's quality system for the design and manufacture of development systems is ISO 9001:2000 certified.*



## WORLDWIDE SALES AND SERVICE

### AMERICAS

**Corporate Office**  
2355 West Chandler Blvd.  
Chandler, AZ 85224-6199  
Tel: 480-792-7200  
Fax: 480-792-7277  
Technical Support:  
<http://support.microchip.com>  
Web Address:  
[www.microchip.com](http://www.microchip.com)

**Atlanta**  
Duluth, GA  
Tel: 678-957-9614  
Fax: 678-957-1455

**Boston**  
Westborough, MA  
Tel: 774-760-0087  
Fax: 774-760-0088

**Chicago**  
Itasca, IL  
Tel: 630-285-0071  
Fax: 630-285-0075

**Dallas**  
Addison, TX  
Tel: 972-818-7423  
Fax: 972-818-2924

**Detroit**  
Farmington Hills, MI  
Tel: 248-538-2250  
Fax: 248-538-2260

**Kokomo**  
Kokomo, IN  
Tel: 765-864-8360  
Fax: 765-864-8387

**Los Angeles**  
Mission Viejo, CA  
Tel: 949-462-9523  
Fax: 949-462-9608

**Santa Clara**  
Santa Clara, CA  
Tel: 408-961-6444  
Fax: 408-961-6445

**Toronto**  
Mississauga, Ontario,  
Canada  
Tel: 905-673-0699  
Fax: 905-673-6509

### ASIA/PACIFIC

**Asia Pacific Office**  
Suites 3707-14, 37th Floor  
Tower 6, The Gateway  
Harbour City, Kowloon  
Hong Kong  
Tel: 852-2401-1200  
Fax: 852-2401-3431

**Australia - Sydney**  
Tel: 61-2-9868-6733  
Fax: 61-2-9868-6755

**China - Beijing**  
Tel: 86-10-8528-2100  
Fax: 86-10-8528-2104

**China - Chengdu**  
Tel: 86-28-8665-5511  
Fax: 86-28-8665-7889

**China - Fuzhou**  
Tel: 86-591-8750-3506  
Fax: 86-591-8750-3521

**China - Hong Kong SAR**  
Tel: 852-2401-1200  
Fax: 852-2401-3431

**China - Qingdao**  
Tel: 86-532-8502-7355  
Fax: 86-532-8502-7205

**China - Shanghai**  
Tel: 86-21-5407-5533  
Fax: 86-21-5407-5066

**China - Shenyang**  
Tel: 86-24-2334-2829  
Fax: 86-24-2334-2393

**China - Shenzhen**  
Tel: 86-755-8203-2660  
Fax: 86-755-8203-1760

**China - Shunde**  
Tel: 86-757-2839-5507  
Fax: 86-757-2839-5571

**China - Wuhan**  
Tel: 86-27-5980-5300  
Fax: 86-27-5980-5118

**China - Xian**  
Tel: 86-29-8833-7250  
Fax: 86-29-8833-7256

### ASIA/PACIFIC

**India - Bangalore**  
Tel: 91-80-4182-8400  
Fax: 91-80-4182-8422

**India - New Delhi**  
Tel: 91-11-4160-8631  
Fax: 91-11-4160-8632

**India - Pune**  
Tel: 91-20-2566-1512  
Fax: 91-20-2566-1513

**Japan - Yokohama**  
Tel: 81-45-471-6166  
Fax: 81-45-471-6122

**Korea - Gumi**  
Tel: 82-54-473-4301  
Fax: 82-54-473-4302

**Korea - Seoul**  
Tel: 82-2-554-7200  
Fax: 82-2-558-5932 or  
82-2-558-5934

**Malaysia - Penang**  
Tel: 60-4-646-8870  
Fax: 60-4-646-5086

**Philippines - Manila**  
Tel: 63-2-634-9065  
Fax: 63-2-634-9069

**Singapore**  
Tel: 65-6334-8870  
Fax: 65-6334-8850

**Taiwan - Hsin Chu**  
Tel: 886-3-572-9526  
Fax: 886-3-572-6459

**Taiwan - Kaohsiung**  
Tel: 886-7-536-4818  
Fax: 886-7-536-4803

**Taiwan - Taipei**  
Tel: 886-2-2500-6610  
Fax: 886-2-2508-0102

**Thailand - Bangkok**  
Tel: 66-2-694-1351  
Fax: 66-2-694-1350

### EUROPE

**Austria - Wels**  
Tel: 43-7242-2244-39  
Fax: 43-7242-2244-393

**Denmark - Copenhagen**  
Tel: 45-4450-2828  
Fax: 45-4485-2829

**France - Paris**  
Tel: 33-1-69-53-63-20  
Fax: 33-1-69-30-90-79

**Germany - Munich**  
Tel: 49-89-627-144-0  
Fax: 49-89-627-144-44

**Italy - Milan**  
Tel: 39-0331-742611  
Fax: 39-0331-466781

**Netherlands - Druen**  
Tel: 31-416-690399  
Fax: 31-416-690340

**Spain - Madrid**  
Tel: 34-91-708-08-90  
Fax: 34-91-708-08-91

**UK - Wokingham**  
Tel: 44-118-921-5869  
Fax: 44-118-921-5820