



MICROCHIP TC4423M/TC4424M/TC4425M

3A Dual High-Speed Power MOSFET Drivers

Features

- High Peak Output Current: 3A
- Wide Input Supply Voltage Operating Range:
 - 4.5V to 18V
- High Capacitive Load Drive Capability:
 - 1800 pF in 25 ns
- Short Delay Times: <40 ns (typ)
- Matched Rise/Fall Times
- Low Supply Current:
 - With Logic '1' Input – 3.5 mA (Max)
 - With Logic '0' Input – 350 μ A (Max)
- Low Output Impedance: 3.5 Ω (typ)
- Latch-Up Protected: Will Withstand 1.5A Reverse Current
- Logic Input: Will Withstand Negative Swing Up To 5V
- ESD Protected: 4 kV
- Pin-compatible with the TC4426M/TC4427M/TC4428M and TC4426AM/TC4427AM/TC4428AM devices
- Wide Operating Temperature Range:
 - -55°C to +125°C
- See TC4423/TC4424/TC4425 Data Sheet (DS21421) for additional temperature range and packaging offerings

Applications

- Switch-mode Power Supplies
- Pulse Transformer Drive
- Line Drivers

General Description

The TC4423M/TC4424M/TC4425M devices are a family of 3A, dual output buffers/MOSFET drivers. Pin-compatible with both the TC4426M/TC4427M/TC4428M and TC4426AM/4427AM/4428AM families (dual 1.5A drivers), the TC4423M/TC4424M/TC4425M family has an increased latch-up current rating of 1.5A, making them even more robust for operation in harsh electrical environments.

As MOSFET drivers, the TC4423M/TC4424M/TC4425M can easily charge 1800 pF gate capacitance in under 35 nsec, while providing low enough impedances in both the on and off states to ensure the MOSFET's intended state will not be affected, even by large transients.

The TC4423M/TC4424M/TC4425M inputs may be driven directly from either TTL or CMOS (2.4V to 18V). In addition, 300 mV of hysteresis is built-in to provide noise immunity and to allow the device to be driven from slowly rising or falling waveforms.

Package Types

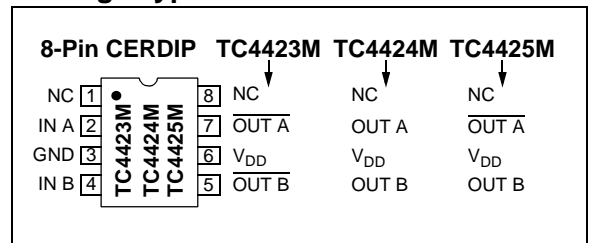

TC4423M/TC4424M/TC4425M

Functional Block Diagram

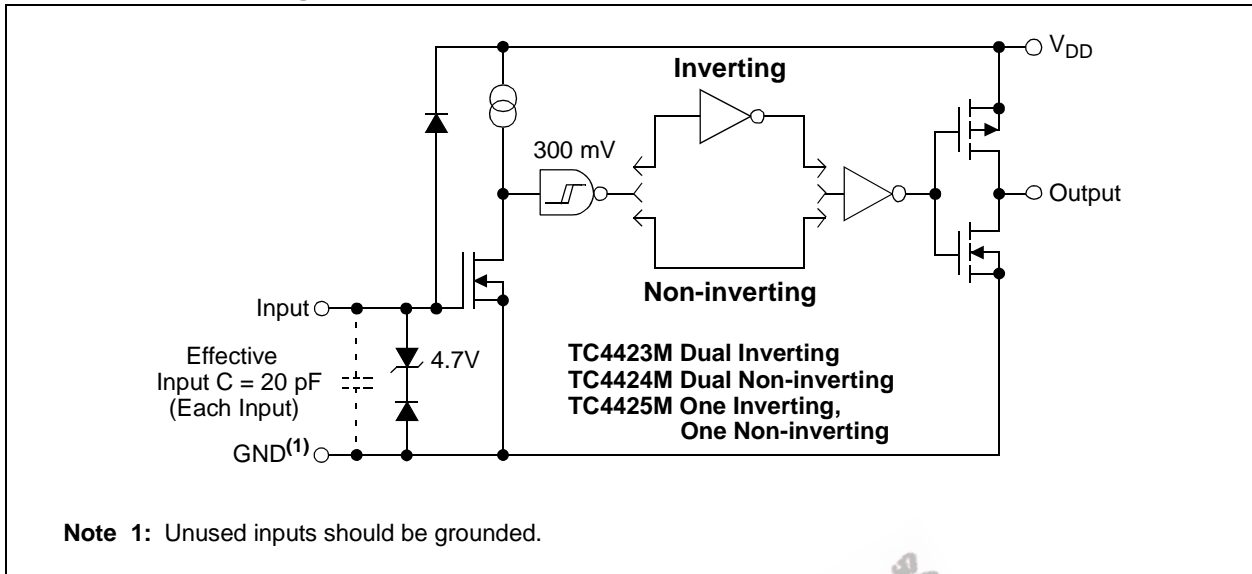

EEPW 电子产品世界 .com.cn

TC4423M/TC4424M/TC4425M

1.0 ELECTRICAL CHARACTERISTICS

† **Notice:** Stresses above those listed under "Maximum Ratings" may cause permanent damage to the device. This is a stress rating only and functional operation of the device at those or any other conditions above those indicated in the operational sections of this specification is not intended. Exposure to maximum rating conditions for extended periods may affect device reliability.

Absolute Maximum Ratings †

Supply Voltage+22V
 Input Voltage, IN A or IN B ($V_{DD} + 0.3V$) to (GND – 5V)

DC CHARACTERISTICS

| Electrical Specifications: Unless otherwise indicated, $T_A = +25^\circ C$, with $4.5V \leq V_{DD} \leq 18V$. | | | | | | |
|---|-----------|------------------|------|-------|----------|--|
| Parameters | Sym | Min | Typ | Max | Units | Conditions |
| Input | | | | | | |
| Logic '1', High Input Voltage | V_{IH} | 2.4 | — | — | V | |
| Logic '0', Low Input Voltage | V_{IL} | — | — | 0.8 | V | |
| Input Current | I_{IN} | -1 | — | 1 | μA | $0V \leq V_{IN} \leq V_{DD}$ |
| Output | | | | | | |
| High Output Voltage | V_{OH} | $V_{DD} - 0.025$ | — | — | V | |
| Low Output Voltage | V_{OL} | — | — | 0.025 | V | |
| Output Resistance, High | R_{OH} | — | 2.8 | 5 | Ω | $I_{OUT} = 10\text{ mA}$, $V_{DD} = 18V$ |
| Output Resistance, Low | R_{OL} | — | 3.5 | 5 | Ω | $I_{OUT} = 10\text{ mA}$, $V_{DD} = 18V$ |
| Peak Output Current | I_{PK} | — | 3 | — | A | |
| Latch-Up Protection Withstand Reverse Current | I_{REV} | — | >1.5 | — | A | Duty cycle $\leq 2\%$, $t \leq 300\ \mu\text{sec}$. |
| Switching Time (Note 1) | | | | | | |
| Rise Time | t_R | — | 23 | 35 | ns | Figure 4-1, Figure 4-2, $C_L = 1800\text{ pF}$ |
| Fall Time | t_F | — | 25 | 35 | ns | Figure 4-1, Figure 4-2, $C_L = 1800\text{ pF}$ |
| Delay Time | t_{D1} | — | 33 | 75 | ns | Figure 4-1, Figure 4-2, $C_L = 1800\text{ pF}$ |
| Delay Time | t_{D2} | — | 38 | 75 | ns | Figure 4-1, Figure 4-2, $C_L = 1800\text{ pF}$ |
| Power Supply | | | | | | |
| Power Supply Current | I_S | — | 1.5 | 2.5 | mA | $V_{IN} = 3V$ (Both inputs) $V_{IN} = 0V$ (Both inputs) |

Note 1: Switching times ensured by design.

TC4423M/TC4424M/TC4425M

DC CHARACTERISTICS (OVER OPERATING TEMPERATURE RANGE)

| Electrical Specifications: Unless otherwise indicated, operating temperature range with $4.5V \leq V_{DD} \leq 18V$. | | | | | | |
|--|-----------|------------------|------|-------|----------|--|
| Parameters | Sym | Min | Typ | Max | Units | Conditions |
| Input | | | | | | |
| Logic '1', High Input Voltage | V_{IH} | 2.4 | — | — | V | |
| Logic '0', Low Input Voltage | V_{IL} | — | — | 0.8 | V | |
| Input Current | I_{IN} | -10 | — | +10 | μA | $0V \leq V_{IN} \leq V_{DD}$ |
| Output | | | | | | |
| High Output Voltage | V_{OH} | $V_{DD} - 0.025$ | — | — | V | |
| Low Output Voltage | V_{OL} | — | — | 0.025 | V | |
| Output Resistance, High | R_{OH} | — | 3.7 | 8 | Ω | $I_{OUT} = 10 \text{ mA}, V_{DD} = 18V$ |
| Output Resistance, Low | R_{OL} | — | 4.3 | 8 | Ω | $I_{OUT} = 10 \text{ mA}, V_{DD} = 18V$ |
| Peak Output Current | I_{PK} | — | 3.0 | — | A | |
| Latch-Up Protection Withstand Reverse Current | I_{REV} | — | >1.5 | — | A | Duty cycle $\leq 2\%$, $t \leq 300 \mu\text{sec}$ |
| Switching Time (Note 1) | | | | | | |
| Rise Time | t_R | — | 28 | 60 | ns | Figure 4-1, Figure 4-2, $C_L = 1800 \text{ pF}$ |
| Fall Time | t_F | — | 32 | 60 | ns | Figure 4-1, Figure 4-2, $C_L = 1800 \text{ pF}$ |
| Delay Time | t_{D1} | — | 32 | 100 | ns | Figure 4-1, Figure 4-2, $C_L = 1800 \text{ pF}$ |
| Delay Time | t_{D2} | — | 38 | 100 | ns | Figure 4-1, Figure 4-2, $C_L = 1800 \text{ pF}$ |
| Power Supply | | | | | | |
| Power Supply Current | I_S | — | 2.0 | 3.5 | mA | $V_{IN} = 3V$ (Both inputs) $V_{IN} = 0V$ (Both inputs) |

Note 1: Switching times ensured by design.

TEMPERATURE CHARACTERISTICS

| Electrical Specifications: Unless otherwise noted, all parameters apply with $4.5V \leq V_{DD} \leq 18V$. | | | | | | |
|---|---------------|-----|-----|------|---------------|------------|
| Parameters | Sym | Min | Typ | Max | Units | Conditions |
| Temperature Ranges | | | | | | |
| Specified Temperature Range (M) | T_A | -55 | — | +125 | $^{\circ}C$ | |
| Maximum Junction Temperature | T_J | — | — | +150 | $^{\circ}C$ | |
| Storage Temperature Range | T_A | -65 | — | +150 | $^{\circ}C$ | |
| Package Thermal Resistances | | | | | | |
| Thermal Resistance, 8L-CERDIP | θ_{JA} | — | 150 | — | $^{\circ}C/W$ | |

TC4423M/TC4424M/TC4425M

2.0 TYPICAL PERFORMANCE CURVES

Note: The graphs and tables provided following this note are a statistical summary based on a limited number of samples and are provided for informational purposes only. The performance characteristics listed herein are not tested or guaranteed. In some graphs or tables, the data presented may be outside the specified operating range (e.g., outside specified power supply range) and therefore outside the warranted range.

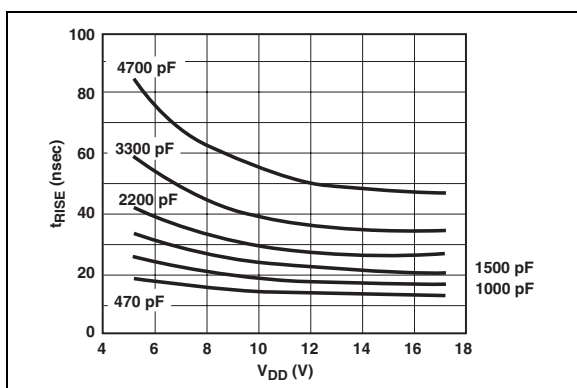

FIGURE 2-1: Rise Time vs. Supply Voltage.

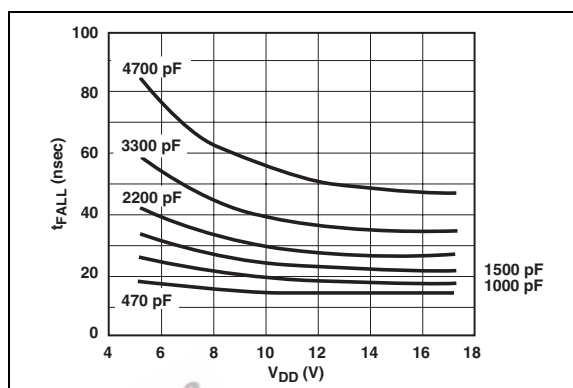

FIGURE 2-4: Fall Time vs. Supply Voltage.

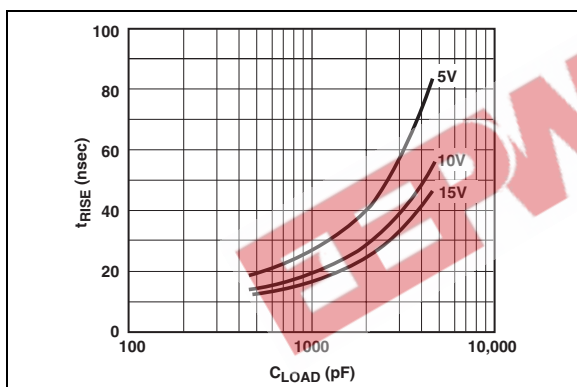

FIGURE 2-2: Rise Time vs. Capacitive Load.

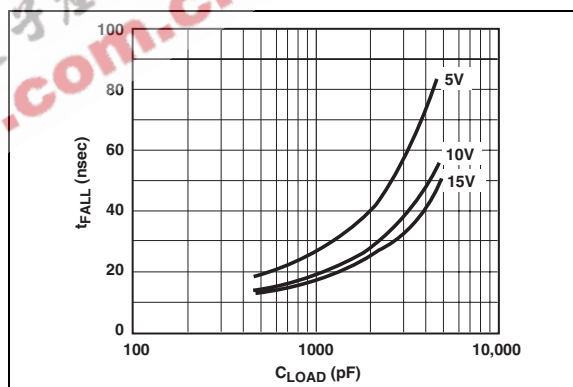

FIGURE 2-5: Fall Time vs. Capacitive Load.

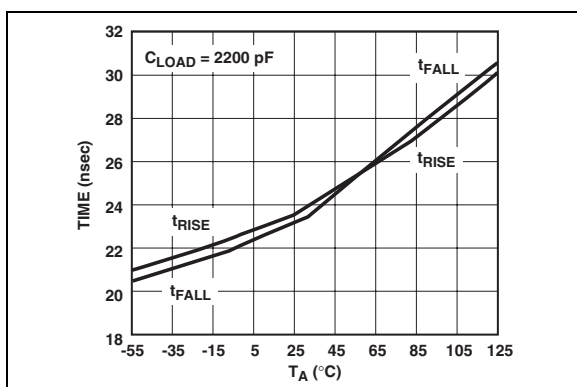

FIGURE 2-3: Rise and Fall Times vs. Temperature.

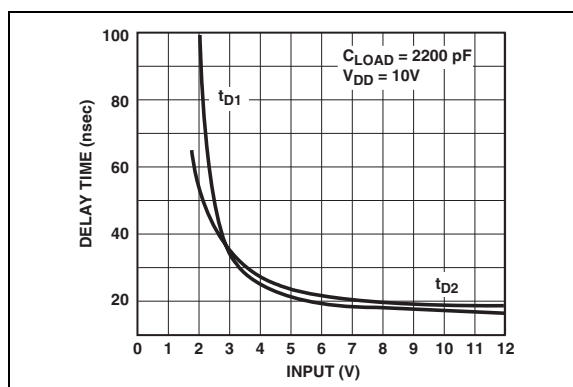

FIGURE 2-6: Propagation Delay vs. Input Amplitude.

TC4423M/TC4424M/TC4425M

Typical Performance Curves (Continued)

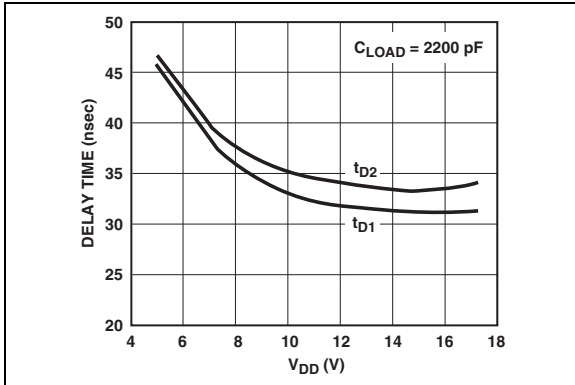

FIGURE 2-7: Propagation Delay Time vs. Supply Voltage.

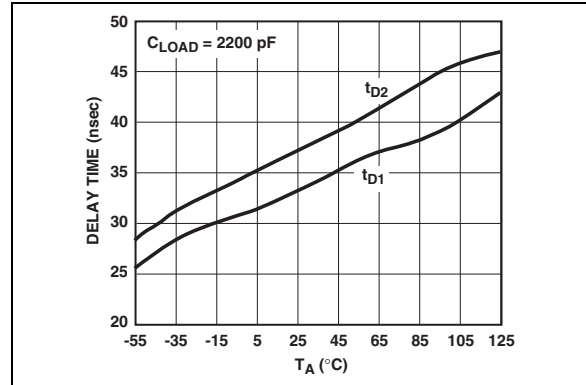

FIGURE 2-10: Propagation Delay Time vs. Temperature.

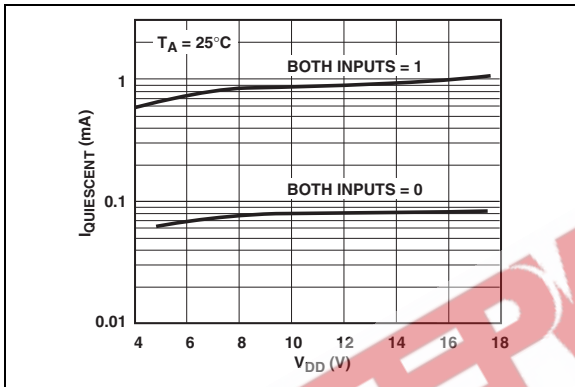

FIGURE 2-8: Quiescent Current vs. Supply Voltage.

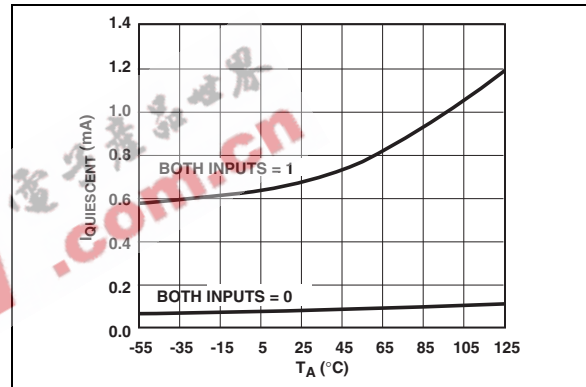

FIGURE 2-11: Quiescent Current vs. Temperature.

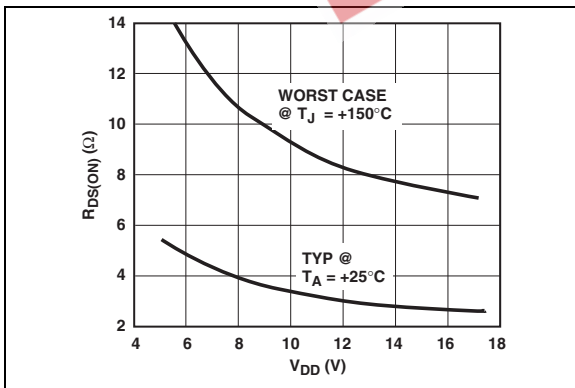

FIGURE 2-9: Output Resistance (Output High) vs. Supply Voltage.

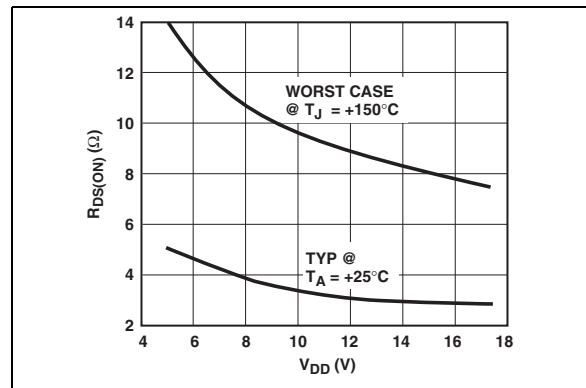

FIGURE 2-12: Output Resistance (Output Low) vs. Supply Voltage.

TC4423M/TC4424M/TC4425M

Typical Performance Curves (Continued)

Note: Load on single output only

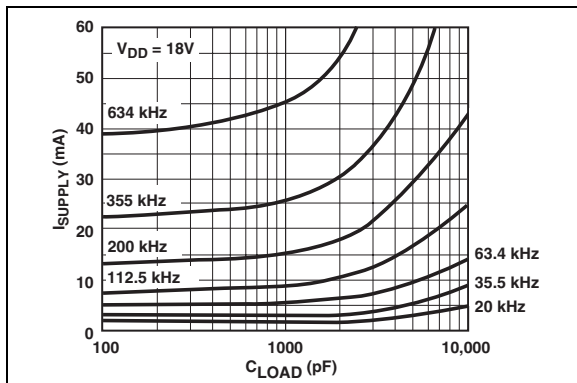

FIGURE 2-13: Supply Current vs. Capacitive Load.

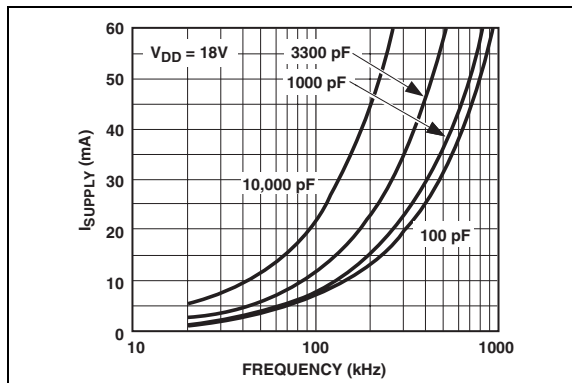

FIGURE 2-16: Supply Current vs. Frequency.

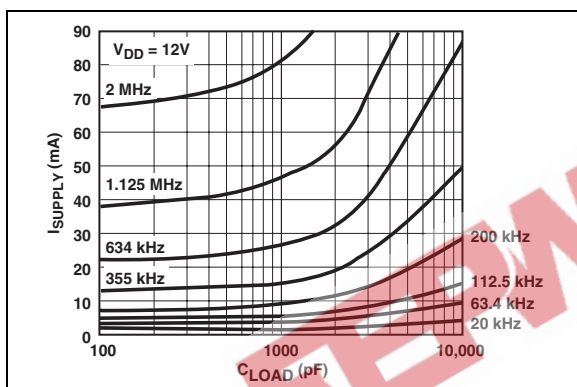

FIGURE 2-14: Supply Current vs. Capacitive Load.

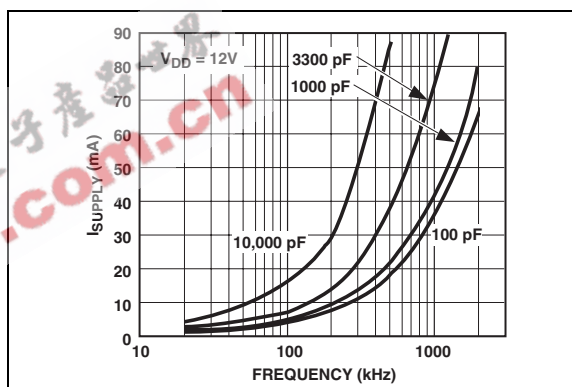

FIGURE 2-17: Supply Current vs. Frequency.

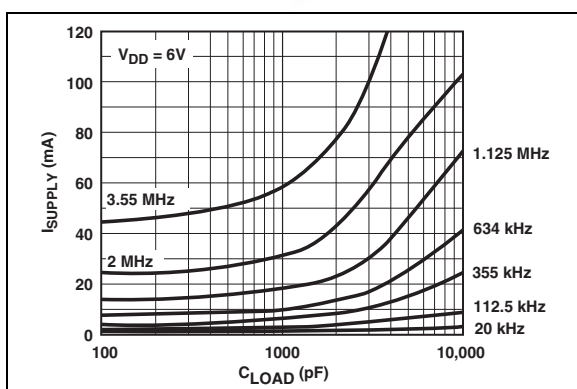

FIGURE 2-15: Supply Current vs. Capacitive Load.

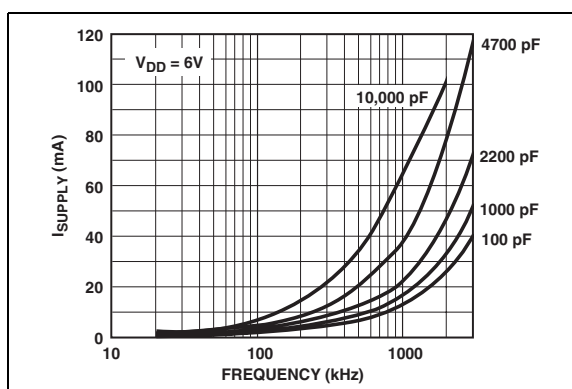

FIGURE 2-18: Supply Current vs. Frequency.

TC4423M/TC4424M/TC4425M

Typical Performance Curves (Continued)

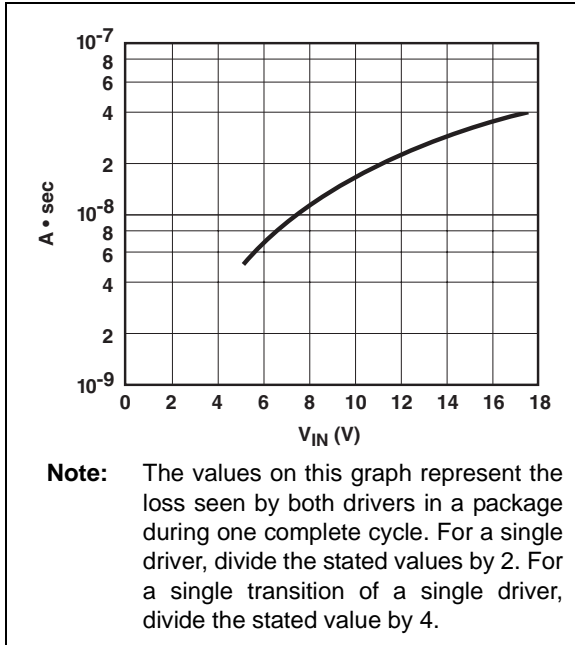

FIGURE 2-19: TC4423M Crossover Energy.

EEPW.com.cn 电子产品世界

TC4423M/TC4424M/TC4425M

3.0 PIN DESCRIPTIONS

The descriptions of the pins are listed in Table 3-1.

TABLE 3-1: PIN FUNCTION TABLE

| 8-Pin CERDIP | Symbol | Description |
|--------------|-----------------|---------------|
| 1 | NC | No connection |
| 2 | IN A | Input A |
| 3 | GND | Ground |
| 4 | IN B | Input B |
| 5 | OUT B | Output B |
| 6 | V _{DD} | Supply input |
| 7 | OUT A | Output A |
| 8 | NC | No connection |

3.1 Input A (IN A)

IN A is a TTL/CMOS-compatible input that controls OUT A. This input has 300 mV of hysteresis between the high and low input levels that allows it to be driven from slow rising and falling signals, as well as providing noise immunity.

3.2 Input B (IN B)

IN B is a TTL/CMOS-compatible input that controls OUT B. This input has 300 mV of hysteresis between the high and low input levels that allows it to be driven from slow rising and falling signals, as well as providing noise immunity.

3.3 Output B (OUT B)

OUT B is a CMOS push-pull output that is capable of sourcing and sinking 3A peaks of current ($V_{DD} = 18V$). The low output impedance ensures the gate of the external MOSFET will stay in the intended state even during large transients. This output also has a reverse current latch-up rating of 1.5A.

3.4 Output A (OUT A)

OUT A is a CMOS, push-pull output that is capable of sourcing and sinking 3A peaks of current ($V_{DD} = 18V$). The low output impedance ensures the gate of the external MOSFET will stay in the intended state even during large transients. This output also has a reverse current latch-up rating of 1.5A.

3.5 Supply Input (V_{DD})

V_{DD} is the bias supply input for the MOSFET driver and has a voltage range of 4.5V to 18V. This input must be decoupled to ground with a local ceramic capacitor. This bypass capacitor provides a localized low-impedance path for the peak currents that are to be provided to the load.

3.6 Ground (GND)

GND is the device return pin. The ground pin(s) should have a low-impedance connection to the bias supply source return. High peak currents will flow out the ground pin(s) when the capacitive load is being discharged.

TC4423M/TC4424M/TC4425M

4.0 APPLICATIONS INFORMATION

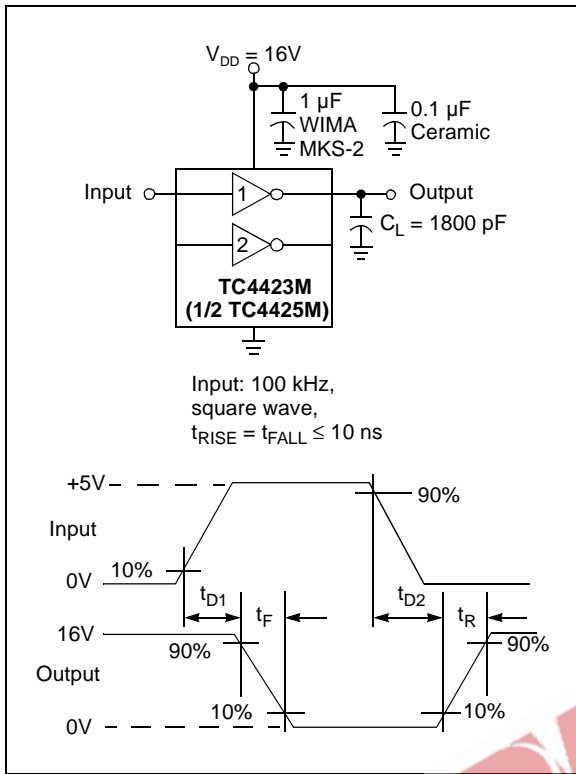

FIGURE 4-1: Inverting Driver Switching Time.

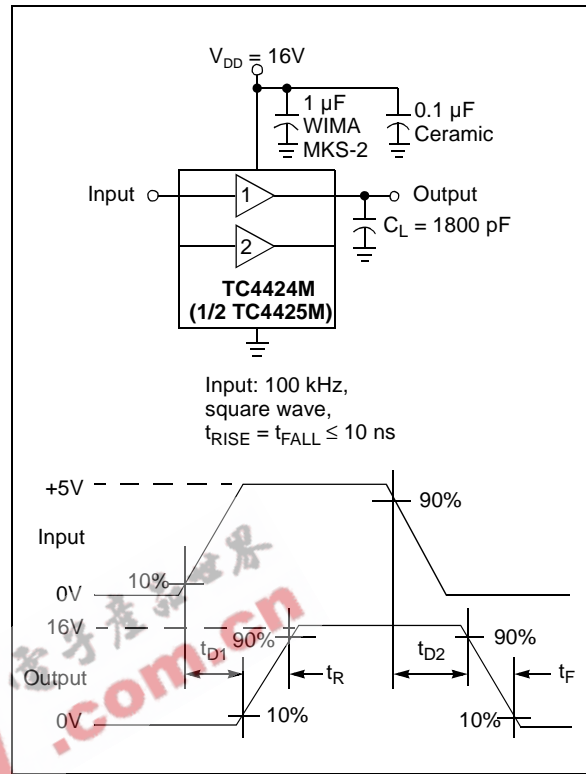

FIGURE 4-2: Non-inverting Driver Switching Time.

TC4423M/TC4424M/TC4425M

5.0 PACKAGING INFORMATION

5.1 Package Marking Information

8-Lead CERDIP (300 mil)

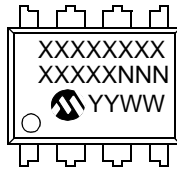

Example:

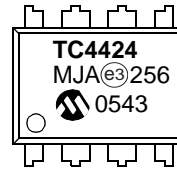

| | | |
|----------------|-----------------|---|
| Legend: | XX...X | Customer-specific information |
| | Y | Year code (last digit of calendar year) |
| | YY | Year code (last 2 digits of calendar year) |
| | WW | Week code (week of January 1 is week '01') |
| | NNN | Alphanumeric traceability code |
| | ^(e3) | Pb-free JEDEC designator for Matte Tin (Sn) |
| | * | This package is Pb-free. The Pb-free JEDEC designator ^(e3) can be found on the outer packaging for this package. |

Note: In the event the full Microchip part number cannot be marked on one line, it will be carried over to the next line, thus limiting the number of available characters for customer-specific information.

TC4423M/TC4424M/TC4425M

8-Lead Ceramic Dual In-line – 300 mil (CERDIP)

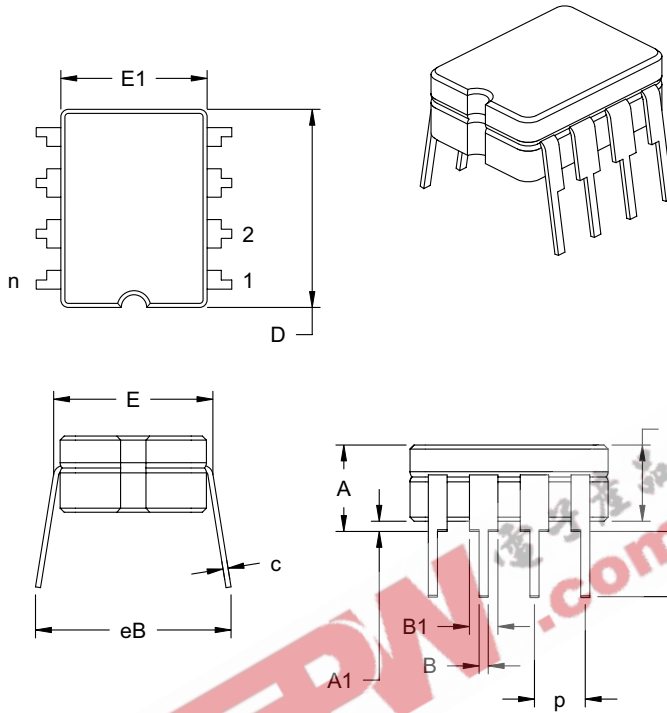

| Dimension Limits | Units | INCHES* | | | MILLIMETERS | | |
|----------------------------|-------|---------|------|------|-------------|------|-------|
| | | MIN | NOM | MAX | MIN | NOM | MAX |
| Number of Pins | n | | 8 | | | 8 | |
| Pitch | p | | .100 | | | 2.54 | |
| Top to Seating Plane | A | .160 | .180 | .200 | 4.06 | 4.57 | 5.08 |
| Standoff § | A1 | .020 | .030 | .040 | 0.51 | 0.77 | 1.02 |
| Shoulder to Shoulder Width | E | .290 | .305 | .320 | 7.37 | 7.75 | 8.13 |
| Ceramic Pkg. Width | E1 | .230 | .265 | .300 | 5.84 | 6.73 | 7.62 |
| Overall Length | D | .370 | .385 | .400 | 9.40 | 9.78 | 10.16 |
| Tip to Seating Plane | L | .125 | .163 | .200 | 3.18 | 4.13 | 5.08 |
| Lead Thickness | c | .008 | .012 | .015 | 0.20 | 0.29 | 0.38 |
| Upper Lead Width | B1 | .045 | .055 | .065 | 1.14 | 1.40 | 1.65 |
| Lower Lead Width | B | .016 | .018 | .020 | 0.41 | 0.46 | 0.51 |
| Overall Row Spacing | eB | .320 | .360 | .400 | 8.13 | 9.15 | 10.16 |

*Controlling Parameter

JEDEC Equivalent: MS-030

Drawing No. C04-010

TC4423M/TC4424M/TC4425M

APPENDIX A: REVISION HISTORY

Revision A (March 2005)

- Original Release of this Document.

EEPW 电子产品世界
.com.cn

TC4423M/TC4424M/TC4425M

NOTES:

EEPW 电子产品世界
.com.cn

TC4423M/TC4424M/TC4425M

PRODUCT IDENTIFICATION SYSTEM

To order or obtain information, e.g., on pricing or delivery, refer to the factory or the listed sales office.

| <u>PART NO.</u> | <u>XX</u> | Examples: |
|-------------------------------------|--|--|
| Device and Temperature Range | Package | |
| Device: | TC4423M: 3A Dual MOSFET Driver, Inverting, -55°C to +125°C TC4424M: 3A Dual MOSFET Driver, Non-Inverting, -55°C to +125°C TC4425M: 3A Dual MOSFET Driver, Complementary, -55°C to +125°C | a) TC4423MJA: 3A Dual MOSFET Driver, Inverting, -55°C to +125°C, 8LD CERDIP package. a) TC4424MJA: 3A Dual MOSFET Driver, Non-Inverting, -55°C to +125°C, 8LD CERDIP package. a) TC4425MJA: 3A Dual MOSFET Driver, Complementary, -55°C to +125°C, 8LD CERDIP package. |
| Package: | JA = Ceramic DIP, (300 mil body), 8-lead | |

EEPW 电子产品世界 .com.cn

TC4423M/TC4424M/TC4425M

NOTES:

EEPW 电子产品世界
.com.cn

Note the following details of the code protection feature on Microchip devices:

- Microchip products meet the specification contained in their particular Microchip Data Sheet.
- Microchip believes that its family of products is one of the most secure families of its kind on the market today, when used in the intended manner and under normal conditions.
- There are dishonest and possibly illegal methods used to breach the code protection feature. All of these methods, to our knowledge, require using the Microchip products in a manner outside the operating specifications contained in Microchip's Data Sheets. Most likely, the person doing so is engaged in theft of intellectual property.
- Microchip is willing to work with the customer who is concerned about the integrity of their code.
- Neither Microchip nor any other semiconductor manufacturer can guarantee the security of their code. Code protection does not mean that we are guaranteeing the product as "unbreakable."

Code protection is constantly evolving. We at Microchip are committed to continuously improving the code protection features of our products. Attempts to break Microchip's code protection feature may be a violation of the Digital Millennium Copyright Act. If such acts allow unauthorized access to your software or other copyrighted work, you may have a right to sue for relief under that Act.

Information contained in this publication regarding device applications and the like is provided only for your convenience and may be superseded by updates. It is your responsibility to ensure that your application meets with your specifications. MICROCHIP MAKES NO REPRESENTATIONS OR WARRANTIES OF ANY KIND WHETHER EXPRESS OR IMPLIED, WRITTEN OR ORAL, STATUTORY OR OTHERWISE, RELATED TO THE INFORMATION, INCLUDING BUT NOT LIMITED TO ITS CONDITION, QUALITY, PERFORMANCE, MERCHANTABILITY OR FITNESS FOR PURPOSE. Microchip disclaims all liability arising from this information and its use. Use of Microchip's products as critical components in life support systems is not authorized except with express written approval by Microchip. No licenses are conveyed, implicitly or otherwise, under any Microchip intellectual property rights.

Trademarks

The Microchip name and logo, the Microchip logo, Accuron, dsPIC, KEELOQ, microID, MPLAB, PIC, PICmicro, PICSTART, PRO MATE, PowerSmart, rfPIC, and SmartShunt are registered trademarks of Microchip Technology Incorporated in the U.S.A. and other countries.

AmpLab, FilterLab, Migratable Memory, MXDEV, MXLAB, PICMASTER, SEEVAL, SmartSensor and The Embedded Control Solutions Company are registered trademarks of Microchip Technology Incorporated in the U.S.A.

Analog-for-the-Digital Age, Application Maestro, dsPICDEM, dsPICDEM.net, dsPICworks, ECAN, ECONOMONITOR, FanSense, FlexROM, fuzzyLAB, In-Circuit Serial Programming, ICSP, ICEPIC, MPASM, MPLIB, MPLINK, MPSIM, PICkit, PICDEM, PICDEM.net, PICLAB, PICtail, PowerCal, PowerInfo, PowerMate, PowerTool, rFLAB, rfPICDEM, Select Mode, Smart Serial, SmartTel, Total Endurance and WiperLock are trademarks of Microchip Technology Incorporated in the U.S.A. and other countries.

SQTP is a service mark of Microchip Technology Incorporated in the U.S.A.

All other trademarks mentioned herein are property of their respective companies.

© 2005, Microchip Technology Incorporated, Printed in the U.S.A., All Rights Reserved.

 Printed on recycled paper.

**QUALITY MANAGEMENT SYSTEM
CERTIFIED BY DNV
== ISO/TS 16949:2002 ==**

Microchip received ISO/TS-16949:2002 quality system certification for its worldwide headquarters, design and wafer fabrication facilities in Chandler and Tempe, Arizona and Mountain View, California in October 2003. The Company's quality system processes and procedures are for its PICmicro® 8-bit MCUs, KEELOQ® code hopping devices, Serial EEPROMs, microperipherals, nonvolatile memory and analog products. In addition, Microchip's quality system for the design and manufacture of development systems is ISO 9001:2000 certified.



WORLDWIDE SALES AND SERVICE

AMERICAS

Corporate Office
2355 West Chandler Blvd.
Chandler, AZ 85224-6199
Tel: 480-792-7200
Fax: 480-792-7277
Technical Support:
<http://support.microchip.com>
Web Address:
www.microchip.com

Atlanta

Alpharetta, GA
Tel: 770-640-0034
Fax: 770-640-0307

Boston

Westford, MA
Tel: 978-692-3848
Fax: 978-692-3821

Chicago

Itasca, IL
Tel: 630-285-0071
Fax: 630-285-0075

Dallas

Addison, TX
Tel: 972-818-7423
Fax: 972-818-2924

Detroit

Farmington Hills, MI
Tel: 248-538-2250
Fax: 248-538-2260

Kokomo

Kokomo, IN
Tel: 765-864-8360
Fax: 765-864-8387

Los Angeles

Mission Viejo, CA
Tel: 949-462-9523
Fax: 949-462-9608

San Jose

Mountain View, CA
Tel: 650-215-1444
Fax: 650-961-0286

Toronto

Mississauga, Ontario,
Canada
Tel: 905-673-0699
Fax: 905-673-6509

ASIA/PACIFIC

Australia - Sydney
Tel: 61-2-9868-6733
Fax: 61-2-9868-6755

China - Beijing
Tel: 86-10-8528-2100
Fax: 86-10-8528-2104

China - Chengdu
Tel: 86-28-8676-6200
Fax: 86-28-8676-6599

China - Fuzhou
Tel: 86-591-8750-3506
Fax: 86-591-8750-3521

China - Hong Kong SAR
Tel: 852-2401-1200
Fax: 852-2401-3431

China - Shanghai
Tel: 86-21-5407-5533
Fax: 86-21-5407-5066

China - Shenyang
Tel: 86-24-2334-2829
Fax: 86-24-2334-2393

China - Shenzhen
Tel: 86-755-8203-2660
Fax: 86-755-8203-1760

China - Shunde
Tel: 86-757-2839-5507
Fax: 86-757-2839-5571

China - Qingdao
Tel: 86-532-502-7355
Fax: 86-532-502-7205

ASIA/PACIFIC

India - Bangalore
Tel: 91-80-2229-0061
Fax: 91-80-2229-0062

India - New Delhi
Tel: 91-11-5160-8631
Fax: 91-11-5160-8632

Japan - Kanagawa
Tel: 81-45-471-6166
Fax: 81-45-471-6122

Korea - Seoul
Tel: 82-2-554-7200
Fax: 82-2-558-5932 or
82-2-558-5934

Singapore
Tel: 65-6334-8870
Fax: 65-6334-8850

Taiwan - Kaohsiung
Tel: 886-7-536-4818
Fax: 886-7-536-4803

Taiwan - Taipei
Tel: 886-2-2500-6610
Fax: 886-2-2508-0102

Taiwan - Hsinchu
Tel: 886-3-572-9526
Fax: 886-3-572-6459

EUROPE

Austria - Weis
Tel: 43-7242-2244-399
Fax: 43-7242-2244-393

Denmark - Ballerup
Tel: 45-4450-2828
Fax: 45-4485-2829

France - Massy
Tel: 33-1-69-53-63-20
Fax: 33-1-69-30-90-79

Germany - Ismaning
Tel: 49-89-627-144-0
Fax: 49-89-627-144-44

Italy - Milan
Tel: 39-0331-742611
Fax: 39-0331-466781

Netherlands - Druen
Tel: 31-416-690399
Fax: 31-416-690340

England - Berkshire
Tel: 44-118-921-5869
Fax: 44-118-921-5820