

## 9A High-Speed MOSFET Drivers

### Features

- High Peak Output Current: 9A
- Wide Input Supply Voltage Operating Range:
  - 4.5V to 18V
- High Continuous Output Current: 2A Max
- Fast Rise and Fall Times:
  - 30 ns with 4,700 pF Load
  - 180 ns with 47,000 pF Load
- Short Propagation Delays: 30 ns (typ)
- Low Supply Current:
  - With Logic '1' Input – 200  $\mu$ A (typ)
  - With Logic '0' Input – 55  $\mu$ A (typ)
- Low Output Impedance: 1.4 $\Omega$  (typ)
- Latch-Up Protected: Will Withstand 1.5A Output Reverse Current
- Input Will Withstand Negative Inputs Up To 5V
- Pin-Compatible with the TC4420/TC4429 6A MOSFET Driver
- Space-saving 8-Pin 6x5 DFN Package

### Applications

- Line Drivers for Extra Heavily-Loaded Lines
- Pulse Generators
- Driving the Largest MOSFETs and IGBTs
- Local Power ON/OFF Switch
- Motor and Solenoid Driver

### General Description

The TC4421/TC4422 are high-current buffer/drivers capable of driving large MOSFETs and IGBTs.

These devices are essentially immune to any form of upset, except direct overvoltage or over-dissipation. They cannot be latched under any conditions within their power and voltage ratings. These parts are not subject to damage or improper operation when up to 5V of ground bounce is present on their ground terminals. They can accept, without damage or logic upset, more than 1A inductive current of either polarity being forced back into their outputs. In addition, all terminals are fully protected against up to 4 kV of electrostatic discharge.

The TC4421/TC4422 inputs may be driven directly from either TTL or CMOS (3V to 18V). In addition, 300 mV of hysteresis is built into the input, providing noise immunity and allowing the device to be driven from slowly rising or falling waveforms.

With both surface-mount and pin-through-hole packages and four operating temperature range offerings, the TC4421/22 family of 9A MOSFET drivers fit into most any application where high gate/line capacitance drive is required.

### Package Types<sup>(1)</sup>

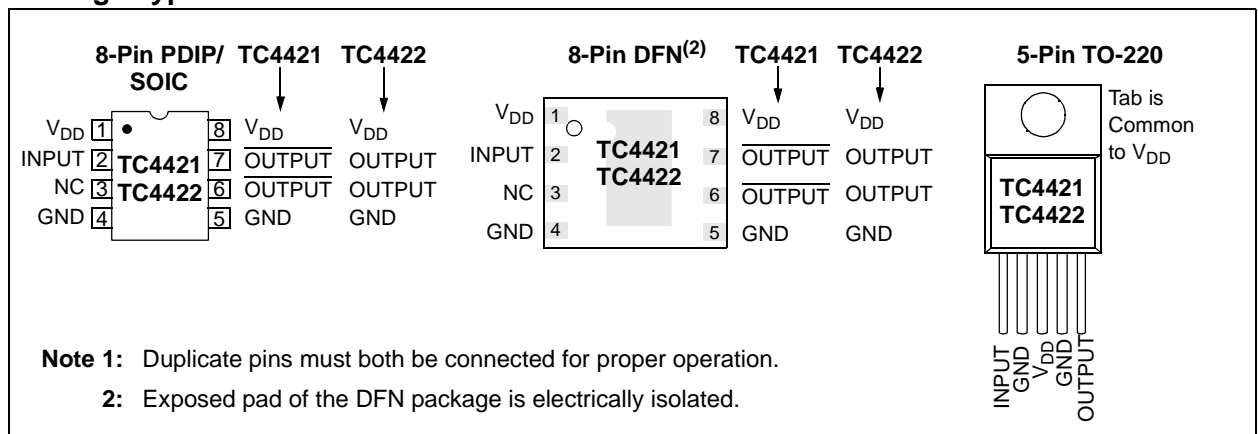

# TC4421/TC4422

## Functional Block Diagram

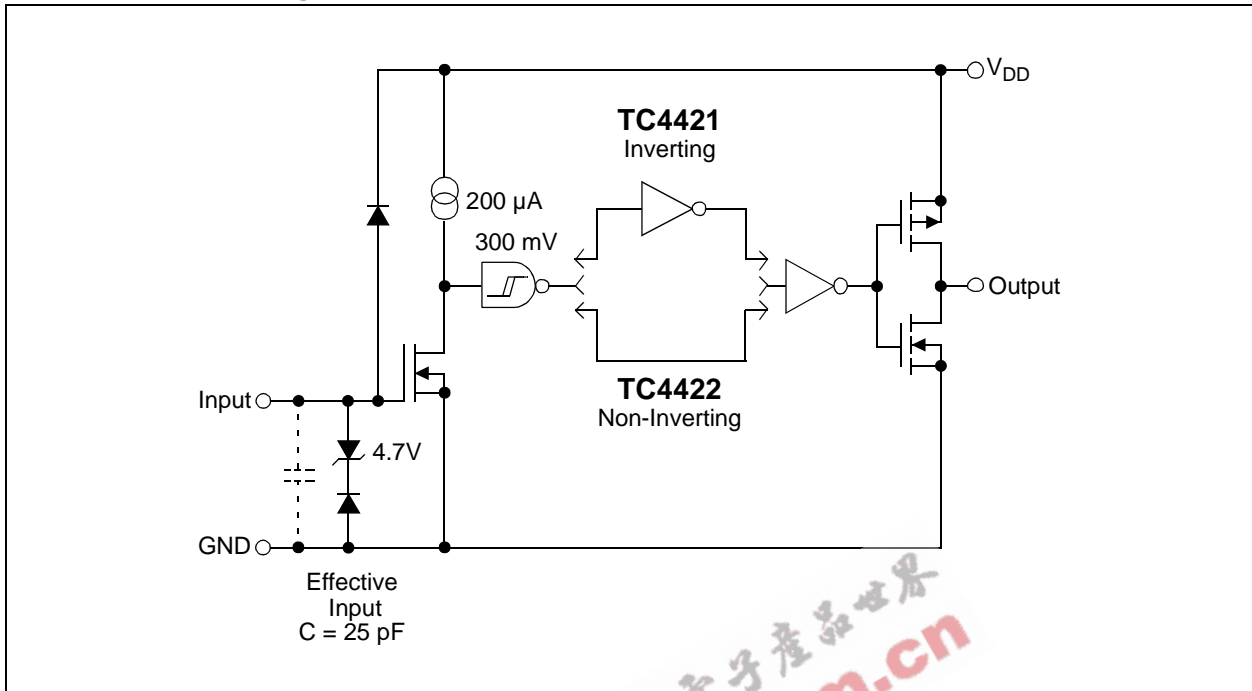

# TC4421/TC4422

## 1.0 ELECTRICAL CHARACTERISTICS

### Absolute Maximum Ratings†

Supply Voltage .....	+20V
Input Voltage .....	( $V_{DD} + 0.3V$ ) to (GND – 5V)
Input Current ( $V_{IN} > V_{DD}$ ) .....	50 mA
Package Power Dissipation ( $T_A \leq 70^\circ C$ )	
5-Pin TO-220 .....	1.6W
DFN .....	<b>Note 2</b>
PDIP .....	730 mW
SOIC .....	750 mW
Package Power Dissipation ( $T_A \leq 25^\circ C$ )	
5-Pin TO-220 (With Heatsink) .....	12.5W
Thermal Impedances (To Case)	
5-Pin TO-220 $R_{\theta J-C}$ .....	10°C/W

† Stresses above those listed under “Absolute Maximum Ratings” may cause permanent damage to the device. These are stress ratings only and functional operation of the device at these or any other conditions above those indicated in the operation sections of the specifications is not implied. Exposure to Absolute Maximum Rating conditions for extended periods may affect device reliability.

## DC CHARACTERISTICS

Electrical Specifications: Unless otherwise noted, $T_A = +25^\circ C$ with $4.5V \leq V_{DD} \leq 18V$ .						
Parameters	Sym	Min	Typ	Max	Units	Conditions
<b>Input</b>						
Logic '1', High Input Voltage	$V_{IH}$	2.4	1.8	—	V	
Logic '0', Low Input Voltage	$V_{IL}$	—	1.3	0.8	V	
Input Current	$I_{IN}$	-10	—	+10	$\mu A$	$0V \leq V_{IN} \leq V_{DD}$
<b>Output</b>						
High Output Voltage	$V_{OH}$	$V_{DD} - 0.025$	—	—	V	DC TEST
Low Output Voltage	$V_{OL}$	—	—	0.025	V	DC TEST
Output Resistance, High	$R_{OH}$	—	1.4	—	$\Omega$	$I_{OUT} = 10 \text{ mA}$ , $V_{DD} = 18V$
Output Resistance, Low	$R_{OL}$	—	0.9	1.7	$\Omega$	$I_{OUT} = 10 \text{ mA}$ , $V_{DD} = 18V$
Peak Output Current	$I_{PK}$	—	9.0	—	A	$V_{DD} = 18V$
Continuous Output Current	$I_{DC}$	2	—	—	A	$10V \leq V_{DD} \leq 18V$ , $T_A = +25^\circ C$ (TC4421/TC4422 CAT only) ( <b>Note 3</b> )
Latch-Up Protection Withstand Reverse Current	$I_{REV}$	—	>1.5	—	A	Duty cycle $\leq 2\%$ , $t \leq 300 \mu\text{sec}$
<b>Switching Time (Note 1)</b>						
Rise Time	$t_R$	—	60	75	ns	Figure 4-1, $C_L = 10,000 \text{ pF}$
Fall Time	$t_F$	—	60	75	ns	Figure 4-1, $C_L = 10,000 \text{ pF}$
Delay Time	$t_{D1}$	—	30	60	ns	Figure 4-1
Delay Time	$t_{D2}$	—	33	60	ns	Figure 4-1
<b>Power Supply</b>						
Power Supply Current	$I_S$	—	0.2	1.5	mA	$V_{IN} = 3V$
		—	55	150	$\mu A$	$V_{IN} = 0V$
Operating Input Voltage	$V_{DD}$	4.5	—	18	V	

**Note 1:** Switching times ensured by design.

**2:** Package power dissipation is dependent on the copper pad area on the PCB.

**3:** Tested during characterization, not production tested.

# TC4421/TC4422

## DC CHARACTERISTICS (OVER OPERATING TEMPERATURE RANGE)

<b>Electrical Specifications:</b> Unless otherwise noted, over operating temperature range with $4.5V \leq V_{DD} \leq 18V$ .						
Parameters	Sym	Min	Typ	Max	Units	Conditions
<b>Input</b>						
Logic '1', High Input Voltage	$V_{IH}$	2.4	—	—	V	
Logic '0', Low Input Voltage	$V_{IL}$	—	—	0.8	V	
Input Current	$I_{IN}$	-10	—	+10	$\mu A$	$0V \leq V_{IN} \leq V_{DD}$
<b>Output</b>						
High Output Voltage	$V_{OH}$	$V_{DD} - 0.025$	—	—	V	DC TEST
Low Output Voltage	$V_{OL}$	—	—	0.025	V	DC TEST
Output Resistance, High	$R_{OH}$	—	2.4	3.6	$\Omega$	$I_{OUT} = 10 \text{ mA}$ , $V_{DD} = 18V$
Output Resistance, Low	$R_{OL}$	—	1.8	2.7	$\Omega$	$I_{OUT} = 10 \text{ mA}$ , $V_{DD} = 18V$
<b>Switching Time (Note 1)</b>						
Rise Time	$t_R$	—	60	120	ns	Figure 4-1, $C_L = 10,000 \text{ pF}$
Fall Time	$t_F$	—	60	120	ns	Figure 4-1, $C_L = 10,000 \text{ pF}$
Delay Time	$t_{D1}$	—	50	80	ns	Figure 4-1
Delay Time	$t_{D2}$	—	65	80	ns	Figure 4-1
<b>Power Supply</b>						
Power Supply Current	$I_S$	—	—	3	mA	$V_{IN} = 3V$ $V_{IN} = 0V$
Operating Input Voltage	$V_{DD}$	4.5	—	18	V	

**Note 1:** Switching times ensured by design.

## TEMPERATURE CHARACTERISTICS

<b>Electrical Specifications:</b> Unless otherwise noted, all parameters apply with $4.5V \leq V_{DD} \leq 18V$ .						
Parameters	Sym	Min	Typ	Max	Units	Conditions
<b>Temperature Ranges</b>						
Specified Temperature Range (C)	$T_A$	0	—	+70	$^{\circ}C$	
Specified Temperature Range (E)	$T_A$	-40	—	+85	$^{\circ}C$	
Specified Temperature Range (V)	$T_A$	-40	—	+125	$^{\circ}C$	
Maximum Junction Temperature	$T_J$	—	—	+150	$^{\circ}C$	
Storage Temperature Range	$T_A$	-65	—	+150	$^{\circ}C$	
<b>Package Thermal Resistances</b>						
Thermal Resistance, 5L-TO-220	$\theta_{JA}$	—	71	—	$^{\circ}C/W$	
Thermal Resistance, 8L-6x5 DFN	$\theta_{JA}$	—	33.2	—	$^{\circ}C/W$	Typical 4-layer board with vias to ground plane
Thermal Resistance, 8L-PDIP	$\theta_{JA}$	—	125	—	$^{\circ}C/W$	
Thermal Resistance, 8L-SOIC	$\theta_{JA}$	—	120	—	$^{\circ}C/W$	

## 2.0 TYPICAL PERFORMANCE CURVES

**Note:** The graphs and tables provided following this note are a statistical summary based on a limited number of samples and are provided for informational purposes only. The performance characteristics listed herein are not tested or guaranteed. In some graphs or tables, the data presented may be outside the specified operating range (e.g., outside specified power supply range) and therefore outside the warranted range.

**Note:** Unless otherwise indicated,  $T_A = +25^\circ\text{C}$  with  $4.5\text{V} \leq V_{DD} \leq 18\text{V}$ .

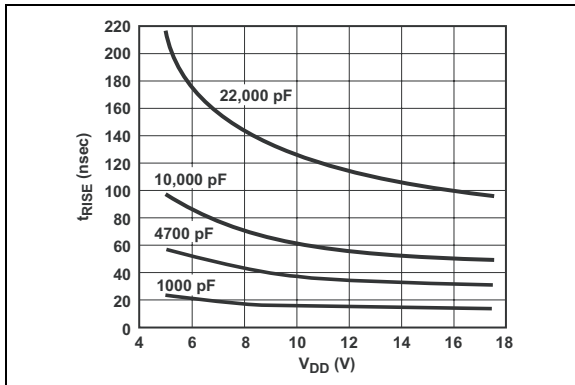

**FIGURE 2-1:** Rise Time vs. Supply Voltage.

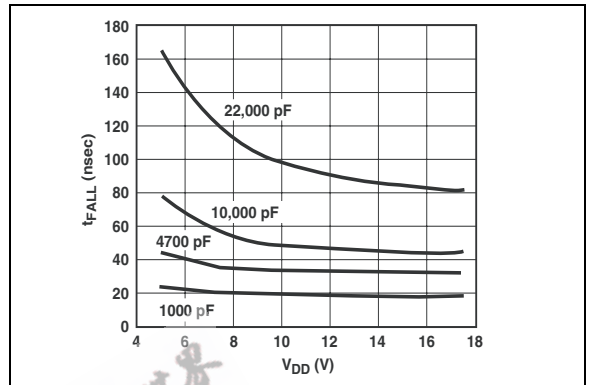

**FIGURE 2-4:** Fall Time vs. Supply Voltage.

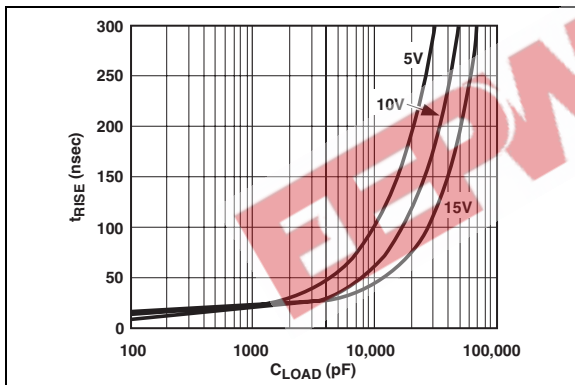

**FIGURE 2-2:** Rise Time vs. Capacitive Load.

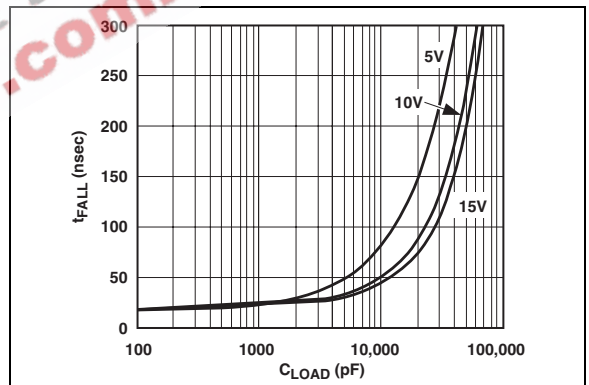

**FIGURE 2-5:** Fall Time vs. Capacitive Load.

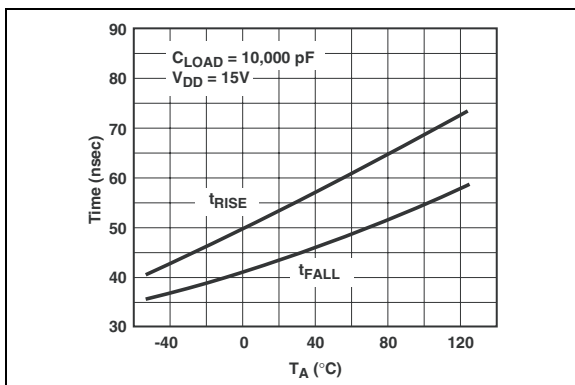

**FIGURE 2-3:** Rise and Fall Times vs. Temperature.

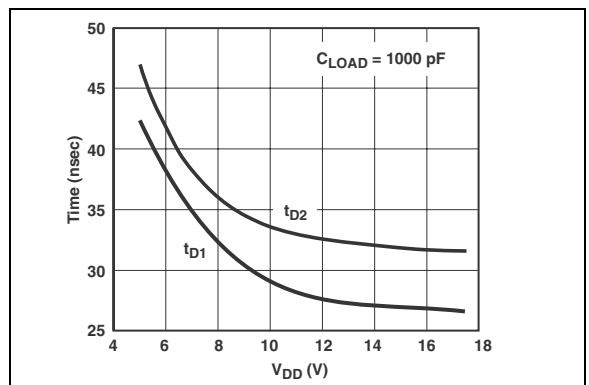

**FIGURE 2-6:** Propagation Delay vs. Supply Voltage.

# TC4421/TC4422

**Note:** Unless otherwise indicated,  $T_A = +25^\circ\text{C}$  with  $4.5\text{V} \leq V_{DD} \leq 18\text{V}$ .

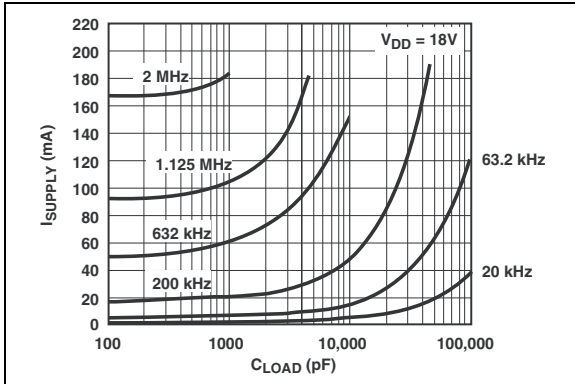

**FIGURE 2-7:** Supply Current vs. Capacitive Load ( $V_{DD} = 18\text{V}$ ).

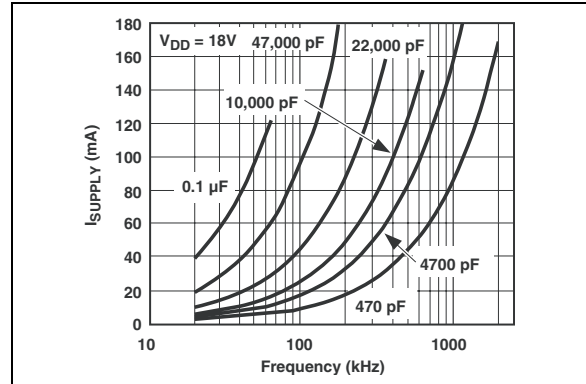

**FIGURE 2-10:** Supply Current vs. Frequency ( $V_{DD} = 18\text{V}$ ).

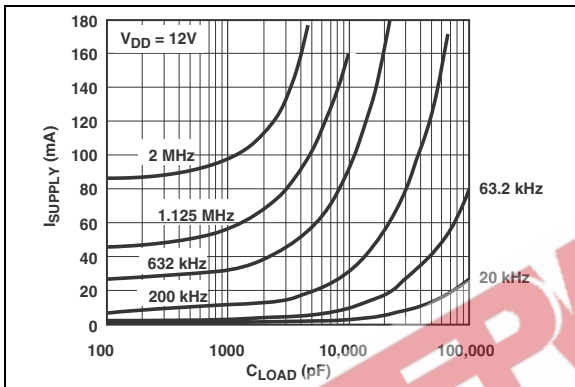

**FIGURE 2-8:** Supply Current vs. Capacitive Load ( $V_{DD} = 12\text{V}$ ).

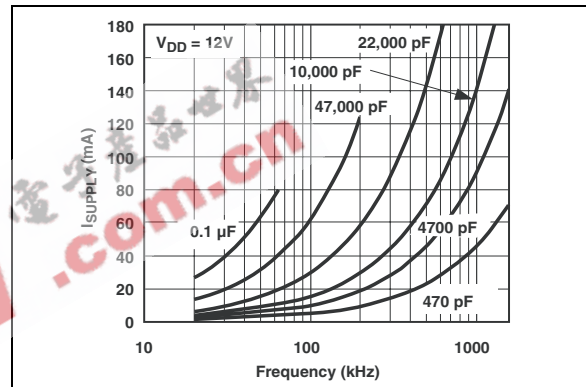

**FIGURE 2-11:** Supply Current vs. Frequency ( $V_{DD} = 12\text{V}$ ).

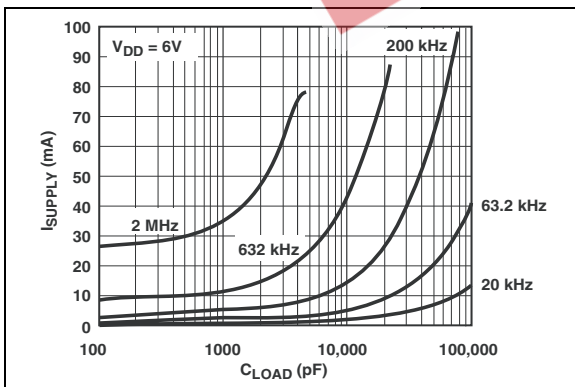

**FIGURE 2-9:** Supply Current vs. Capacitive Load ( $V_{DD} = 6\text{V}$ ).

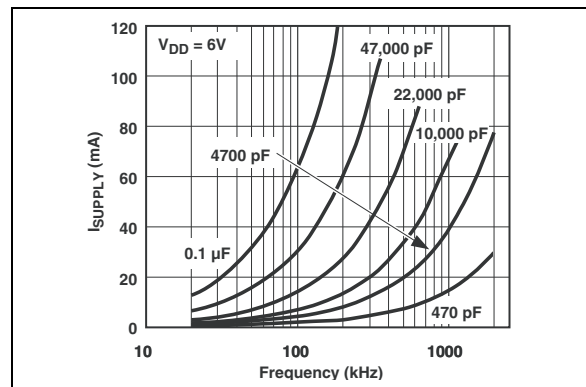

**FIGURE 2-12:** Supply Current vs. Frequency ( $V_{DD} = 6\text{V}$ ).

# TC4421/TC4422

**Note:** Unless otherwise indicated,  $T_A = +25^\circ\text{C}$  with  $4.5\text{V} \leq V_{DD} \leq 18\text{V}$ .

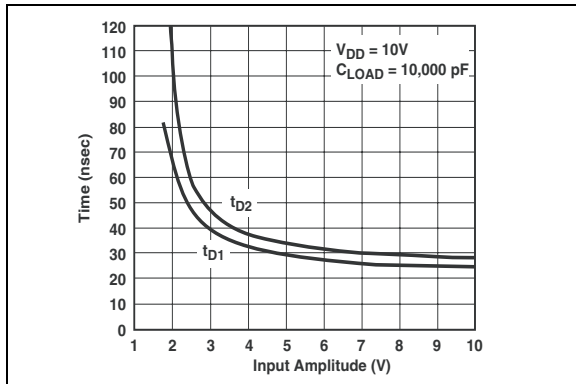

**FIGURE 2-13:** Propagation Delay vs. Input Amplitude.

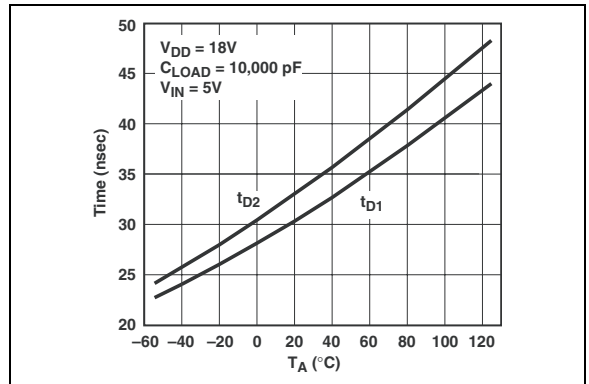

**FIGURE 2-16:** Propagation Delay vs. Temperature.

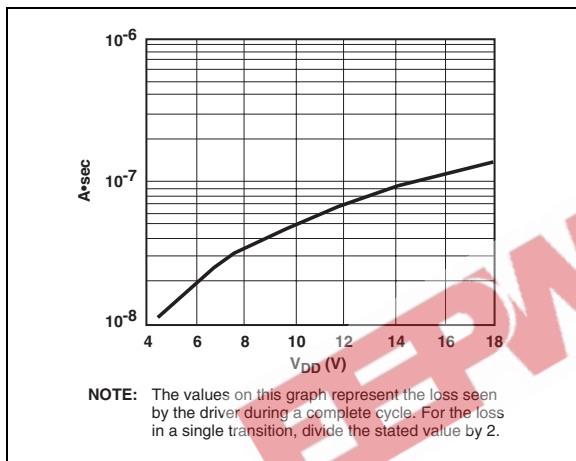

**FIGURE 2-14:** Crossover Energy vs. Supply Voltage.

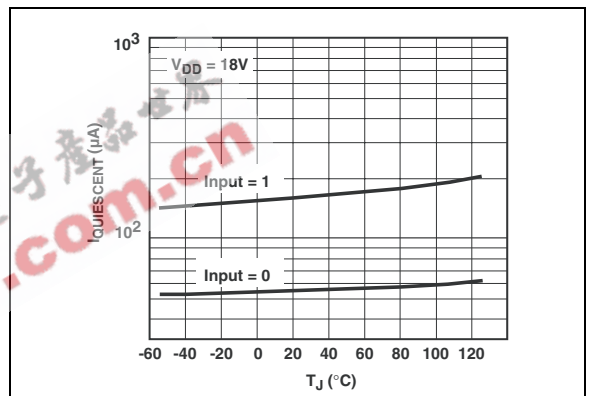

**FIGURE 2-17:** Quiescent Supply Current vs. Temperature.

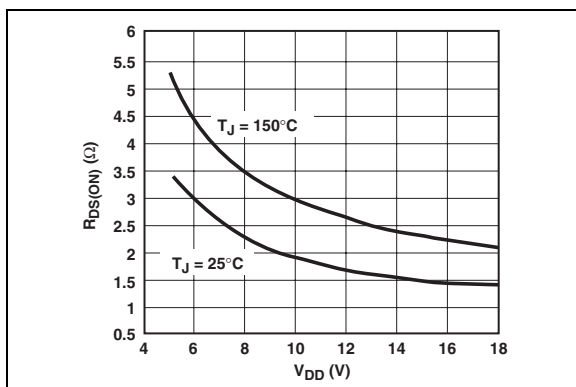

**FIGURE 2-15:** High-State Output Resistance vs. Supply Voltage.

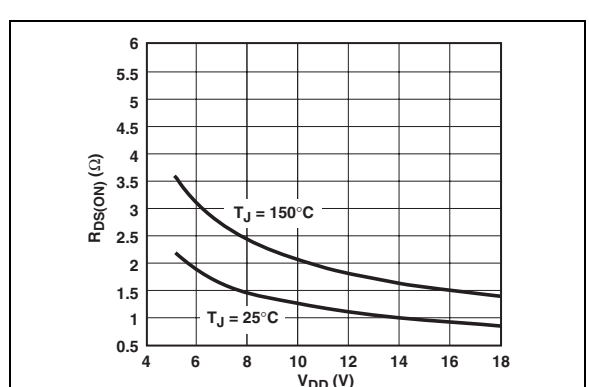

**FIGURE 2-18:** Low-State Output Resistance vs. Supply Voltage.

# TC4421/TC4422

## 3.0 PIN DESCRIPTIONS

The descriptions of the pins are listed in Table 3-1.

TABLE 3-1: PIN FUNCTION TABLE

Pin No. 8-Pin PDIP, SOIC	Pin No. 8-Pin DFN	Pin No. 5-Pin TO-220	Symbol	Description
1	1	—	$V_{DD}$	Supply input, 4.5V to 18V
2	2	1	INPUT	Control input, TTL/CMOS compatible input
3	3	—	NC	No connection
4	4	2	GND	Ground
5	5	4	GND	Ground
6	6	5	OUTPUT	CMOS push-pull output
7	7	—	OUTPUT	CMOS push-pull output
8	8	3	$V_{DD}$	Supply input, 4.5V to 18V
—	PAD	—	NC	Exposed metal pad
—	—	TAB	$V_{DD}$	Metal tab is at the $V_{DD}$ potential

### 3.1 Supply Input ( $V_{DD}$ )

The  $V_{DD}$  input is the bias supply for the MOSFET driver and is rated for 4.5V to 18V with respect to the ground pin. The  $V_{DD}$  input should be bypassed to ground with a local ceramic capacitor. The value of the capacitor should be chosen based on the capacitive load that is being driven. A minimum value of 1.0  $\mu$ F is suggested.

### 3.2 Control Input

The MOSFET driver input is a high-impedance, TTL/CMOS compatible input. The input also has 300 mV of hysteresis between the high and low thresholds that prevents output glitching even when the rise and fall time of the input signal is very slow.

### 3.3 CMOS Push-Pull Output

The MOSFET driver output is a low-impedance, CMOS, push-pull style output capable of driving a capacitive load with 9.0A peak currents. The MOSFET driver output is capable of withstanding 1.5A peak reverse currents of either polarity.

### 3.4 Ground

The ground pins are the return path for the bias current and for the high peak currents that discharge the load capacitor. The ground pins should be tied into a ground plane or have very short traces to the bias supply source return.

### 3.5 Exposed Metal Pad

The exposed metal pad of the 6x5 DFN package is not internally connected to any potential. Therefore, this pad can be connected to a ground plane or other copper plane on a printed circuit board to aid in heat removal from the package.



## 4.0 APPLICATIONS INFORMATION

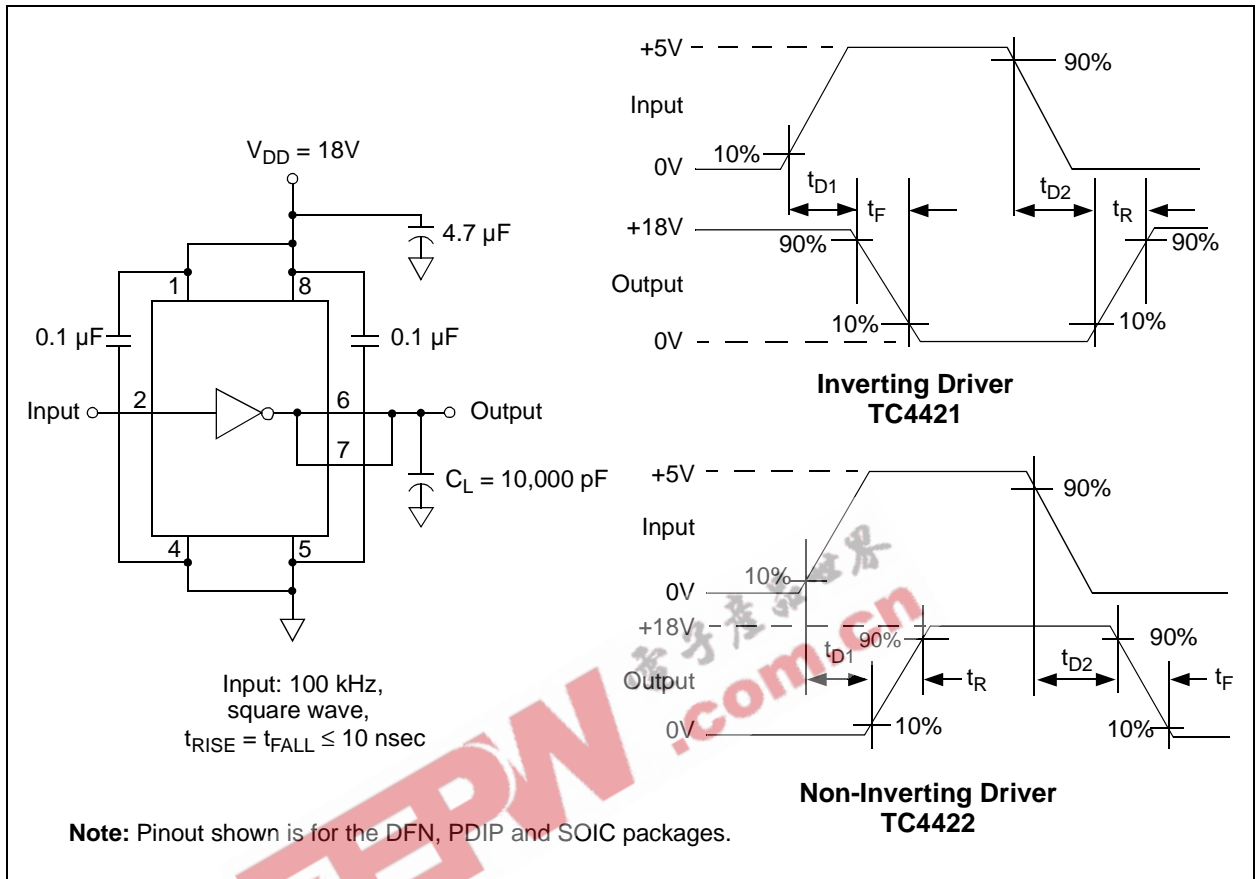

**FIGURE 4-1:** Switching Time Test Circuits.

# TC4421/TC4422

## 5.0 PACKAGING INFORMATION

### 5.1 Package Marking Information

5-Lead TO-220

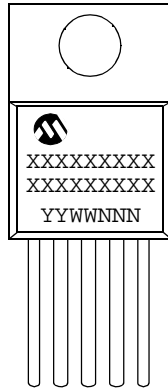

Example:

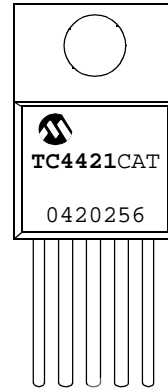

8-Lead DFN

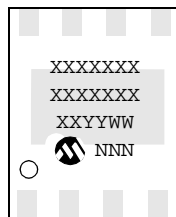

Example:

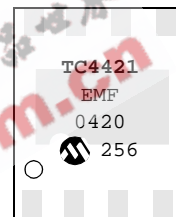

8-Lead PDIP (300 mil)

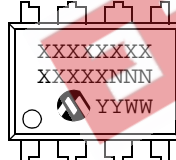

Example:

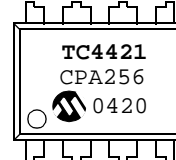

8-Lead SOIC (208 mil)

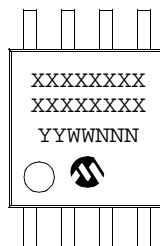

Example:

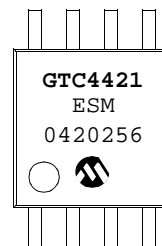

**Legend:** XX...X Customer specific information\*  
 YY Year code (last 2 digits of calendar year)  
 WW Week code (week of January 1 is week '01')  
 NNN Alphanumeric traceability code

**Note:** In the event the full Microchip part number cannot be marked on one line, it will be carried over to the next line thus limiting the number of available characters for customer specific information.

\* Standard OTP marking consists of Microchip part number, year code, week code, and traceability code.

# TC4421/TC4422

## 5-Lead Plastic Transistor Outline (AT) (TO-220)

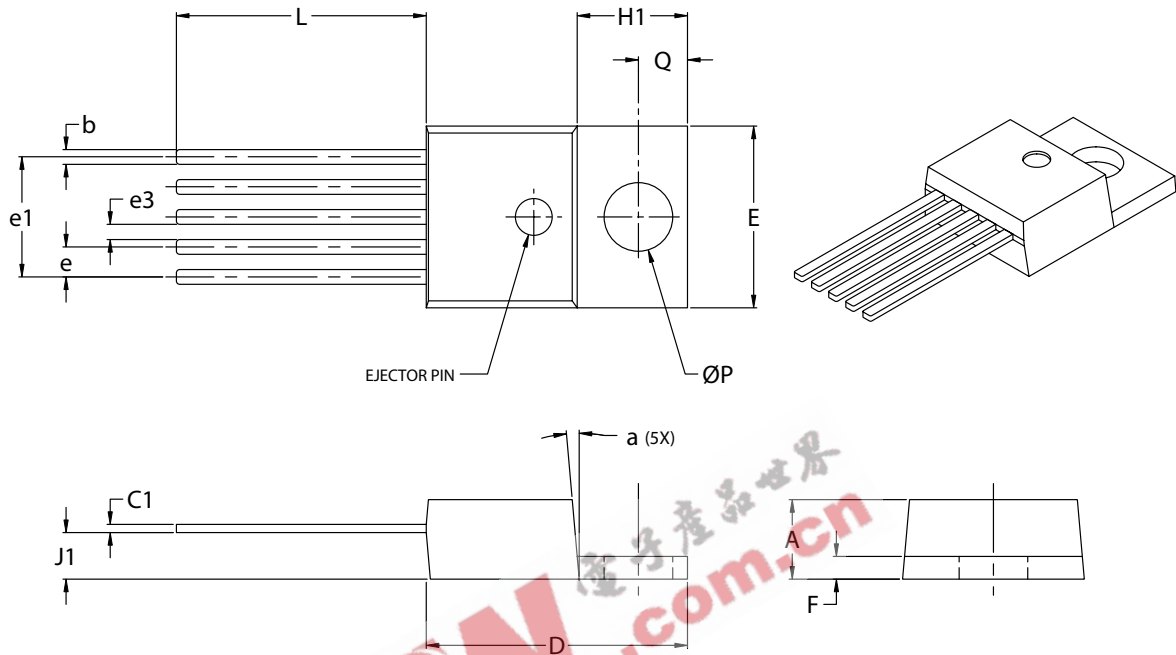

Dimension Limits	Units	INCHES*		MILLIMETERS	
		MIN	MAX	MIN	MAX
Lead Pitch	e	.060	.072	1.52	1.83
Overall Lead Centers	e1	.263	.273	6.68	6.93
Space Between Leads	e3	.030	.040	0.76	1.02
Overall Height	A	.160	.190	4.06	4.83
Overall Width	E	.385	.415	9.78	10.54
Overall Length	D	.560	.590	14.22	14.99
Flag Length	H1	.234	.258	5.94	6.55
Flag Thickness	F	.045	.055	1.14	1.40
Through Hole Center	Q	.103	.113	2.62	2.87
Through Hole Diameter	P	.146	.156	3.71	3.96
Lead Length	L	.540	.560	13.72	14.22
Base to Bottom of Lead	J1	.090	.115	2.29	2.92
Lead Thickness	C1	.014	.022	0.36	0.56
Lead Width	b	.025	.040	0.64	1.02
Mold Draft Angle	a	3°	7°	3°	7°

\*Controlling Parameter

Notes:

Dimensions D and E1 do not include mold flash or protrusions. Mold flash or protrusions shall not exceed .010" (0.254mm) per side.

JEDEC equivalent: TO-220

Drawing No. C04-036

# TC4421/TC4422

## 8-Lead Plastic Dual Flat No Lead Package (MF) 6x5 mm Body (DFN-S) – Saw Singulated

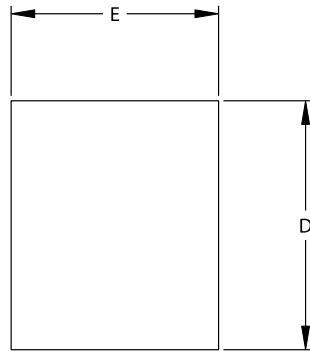

TOP VIEW

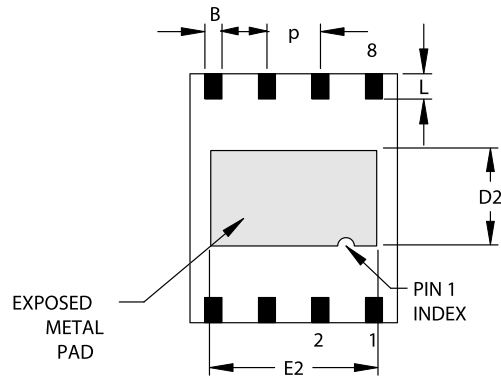

BOTTOM VIEW

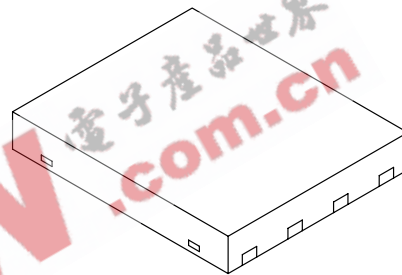
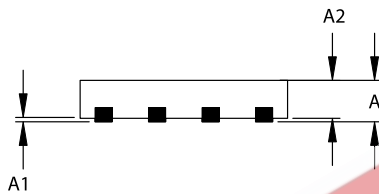

Dimension Limits	Units	INCHES			MILLIMETERS*		
		MIN	NOM	MAX	MIN	NOM	MAX
Number of Pins	n	8			8		
Pitch	P	.050 BSC			1.27 BSC		
Overall Height	A	.033	.035	.037	0.85	0.90	0.95
Package Thickness	A2	.031	.035	.037	0.80	0.89	0.95
Standoff	A1	.000	.0004	.002	0.00	0.01	0.05
Base Thickness	A3	.007	.008	.009	0.17	0.20	0.23
Overall Length	E	.195	.197	.199	4.95	5.00	5.05
Exposed Pad Length	E2	.152	.157	.163	3.85	4.00	4.15
Overall Width	D	.234	.236	.238	5.95	6.00	6.05
Exposed Pad Width	D2	.089	.091	.093	2.25	2.30	2.35
Lead Width	B	.014	.016	.019	0.35	0.40	0.47
Lead Length	L	.024		.026	0.60		0.65

Notes:

JEDEC equivalent: MO-220

Drawing No. C04-122

Revised 11/3/03

# TC4421/TC4422

## 8-Lead Plastic Dual In-line (P) – 300 mil (PDIP)

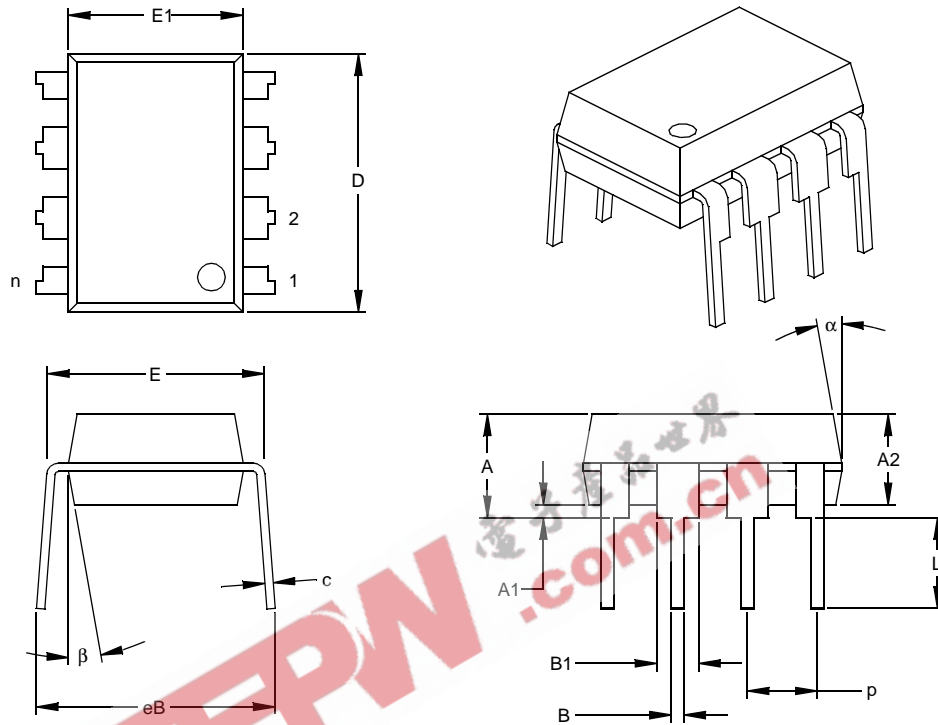

Dimension	Units	INCHES*			MILLIMETERS		
		MIN	NOM	MAX	MIN	NOM	MAX
Number of Pins	n		8			8	
Pitch	P		.100			2.54	
Top to Seating Plane	A	.140	.155	.170	3.56	3.94	4.32
Molded Package Thickness	A2	.115	.130	.145	2.92	3.30	3.68
Base to Seating Plane	A1	.015			0.38		
Shoulder to Shoulder Width	E	.300	.313	.325	7.62	7.94	8.26
Molded Package Width	E1	.240	.250	.260	6.10	6.35	6.60
Overall Length	D	.360	.373	.385	9.14	9.46	9.78
Tip to Seating Plane	L	.125	.130	.135	3.18	3.30	3.43
Lead Thickness	c	.008	.012	.015	0.20	0.29	0.38
Upper Lead Width	B1	.045	.058	.070	1.14	1.46	1.78
Lower Lead Width	B	.014	.018	.022	0.36	0.46	0.56
Overall Row Spacing	§ eB	.310	.370	.430	7.87	9.40	10.92
Mold Draft Angle Top	α	5	10	15	5	10	15
Mold Draft Angle Bottom	β	5	10	15	5	10	15

\* Controlling Parameter  
 § Significant Characteristic

### Notes:

Dimensions D and E1 do not include mold flash or protrusions. Mold flash or protrusions shall not exceed .010" (0.254mm) per side.  
 JEDEC Equivalent: MS-001  
 Drawing No. C04-018

# TC4421/TC4422

**8-Lead Plastic Small Outline (SM) – Medium, 208 mil Body (SOIJ)**  
 (JEITA/EIAJ Standard, Formerly called SOIC)

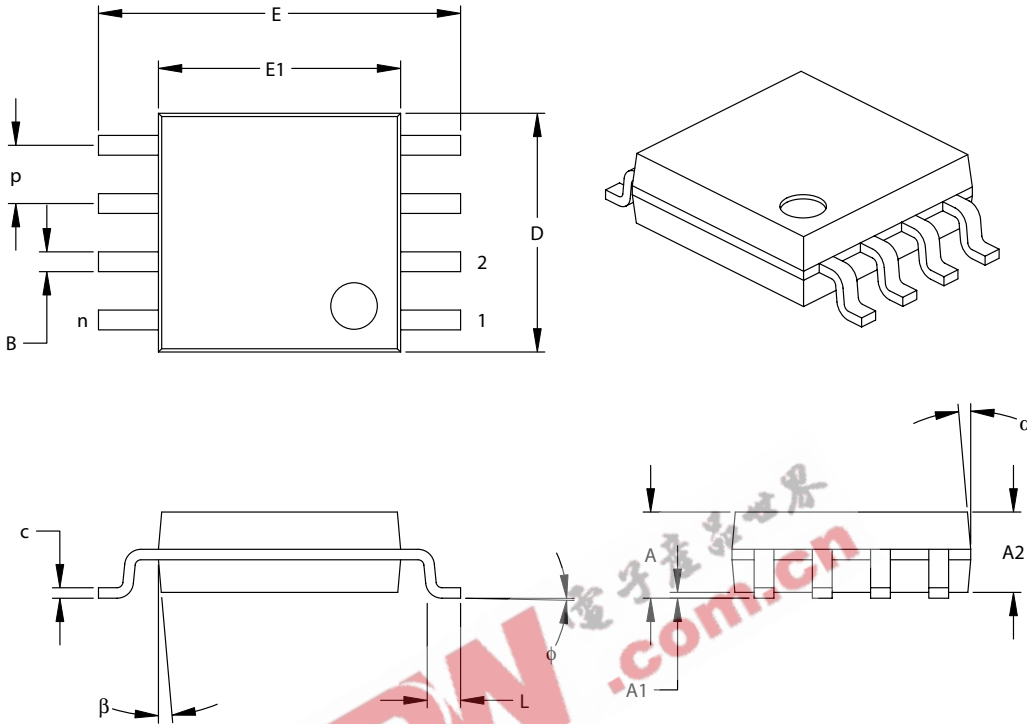

Dimension Limits	Units	INCHES*			MILLIMETERS		
		MIN	NOM	MAX	MIN	NOM	MAX
Number of Pins	n	8			8		
Pitch	P		.050			1.27	
Overall Height	A	.070	.075	.080	1.78	1.97	2.03
Molded Package Thickness	A2	.069	.074	.078	1.75	1.88	1.98
Standoff	A1	.002	.005	.010	0.05	0.13	0.25
Overall Width	E	.300	.313	.325	7.62	7.95	8.26
Molded Package Width	E1	.201	.208	.212	5.11	5.28	5.38
Overall Length	D	.202	.205	.210	5.13	5.21	5.33
Foot Length	L	.020	.025	.030	0.51	0.64	0.76
Foot Angle	$\phi$	0	4	8	0	4	8
Lead Thickness	c	.008	.009	.010	0.20	0.23	0.25
Lead Width	B	.014	.017	.020	0.36	0.43	0.51
Mold Draft Angle Top	$\alpha$	0	12	15	0	12	15
Mold Draft Angle Bottom	$\beta$	0	12	15	0	12	15

\*Controlling Parameter

Notes:

Dimensions D and E1 do not include mold flash or protrusions. Mold flash or protrusions shall not exceed .010" (0.254mm) per side.

Drawing No. C04-056

# TC4421/TC4422

## PRODUCT IDENTIFICATION SYSTEM

To order or obtain information, e.g., on pricing or delivery, refer to the factory or the listed sales office.

<u>PART NO.</u>	<u>X</u>	<u>XX</u>	<u>XXX</u>	<u>X</u>	<b>Examples:</b>
<b>Device</b>	<b>Temperature Range</b>	<b>Package</b>	<b>Tape &amp; Reel</b>	<b>PB Free</b>	
<b>Device:</b> TC4421: 9A High-Speed MOSFET Driver, Inverting TC4422: 9A High-Speed MOSFET Driver, Non-Inverting	<b>Temperature Range:</b> C = 0°C to +70°C (PDIP and TO-220 Only) E = -40°C to +85°C V = -40°C to +125°C	<b>Package:</b> AT = TO-220, 5-lead (C-Temp Only) MF = Dual, Flat, No-Lead (6x5 mm Body), 8-lead MF713 = Dual, Flat, No-Lead (6x5 mm Body), 8-lead (Tape and Reel) PA = Plastic DIP (300 mil Body), 8-lead SM = Plastic SOIC (208 mil Body), 8-lead SM713 = Plastic SOIC (208 mil Body), 8-lead (Tape and Reel)			a) TC4421CAT: 9A High-Speed Inverting MOSFET Driver, TO-220 package, 0°C to +70°C. b) TC4421ESMG: 9A High-Speed Inverting MOSFET Driver, PB Free SOIC package, -40°C to +85°C. c) TC4421VMF: 9A High-Speed Inverting MOSFET Driver, DFN package, -40°C to +125°C.
<b>PB Free</b>				G = Lead-Free device = Blank * Available on selected packages. Contact your local sales representative for availability	a) TC4422VPA: 9A High-Speed Non-Inverting MOSFET Driver, PDIP package, -40°C to +125°C. b) TC4422EPA: 9A High-Speed Non-Inverting MOSFET Driver, PDIP package, -40°C to +85°C. c) TC4422EMF: 9A High-Speed Inverting MOSFET Driver, DFN package, -40°C to +85°C.

## Sales and Support

### Data Sheets

Products supported by a preliminary Data Sheet may have an errata sheet describing minor operational differences and recommended workarounds. To determine if an errata sheet exists for a particular device, please contact one of the following:

1. Your local Microchip sales office
2. The Microchip Corporate Literature Center U.S. FAX: (480) 792-7277
3. The Microchip Worldwide Site ([www.microchip.com](http://www.microchip.com))

Please specify which device, revision of silicon and Data Sheet (include Literature #) you are using.

### Customer Notification System

Register on our web site ([www.microchip.com/cn](http://www.microchip.com/cn)) to receive the most current information on our products.

# TC4421/TC4422

---

NOTES:

EEPW 电子产品世界  
.com.cn



---

---

**Note the following details of the code protection feature on Microchip devices:**

- Microchip products meet the specification contained in their particular Microchip Data Sheet.
- Microchip believes that its family of products is one of the most secure families of its kind on the market today, when used in the intended manner and under normal conditions.
- There are dishonest and possibly illegal methods used to breach the code protection feature. All of these methods, to our knowledge, require using the Microchip products in a manner outside the operating specifications contained in Microchip's Data Sheets. Most likely, the person doing so is engaged in theft of intellectual property.
- Microchip is willing to work with the customer who is concerned about the integrity of their code.
- Neither Microchip nor any other semiconductor manufacturer can guarantee the security of their code. Code protection does not mean that we are guaranteeing the product as "unbreakable."

Code protection is constantly evolving. We at Microchip are committed to continuously improving the code protection features of our products. Attempts to break Microchip's code protection feature may be a violation of the Digital Millennium Copyright Act. If such acts allow unauthorized access to your software or other copyrighted work, you may have a right to sue for relief under that Act.

---

Information contained in this publication regarding device applications and the like is intended through suggestion only and may be superseded by updates. It is your responsibility to ensure that your application meets with your specifications. No representation or warranty is given and no liability is assumed by Microchip Technology Incorporated with respect to the accuracy or use of such information, or infringement of patents or other intellectual property rights arising from such use or otherwise. Use of Microchip's products as critical components in life support systems is not authorized except with express written approval by Microchip. No licenses are conveyed, implicitly or otherwise, under any intellectual property rights.

**Trademarks**

The Microchip name and logo, the Microchip logo, Accuron, dsPIC, KEELOQ, microID, MPLAB, PIC, PICmicro, PICSTART, PRO MATE, PowerSmart, rfPIC, and SmartShunt are registered trademarks of Microchip Technology Incorporated in the U.S.A. and other countries.

AmpLab, FilterLab, MXDEV, MXLAB, PICMASTER, SEEVAL, SmartSensor and The Embedded Control Solutions Company are registered trademarks of Microchip Technology Incorporated in the U.S.A.

Analog-for-the-Digital Age, Application Maestro, dsPICDEM, dsPICDEM.net, dsPICworks, ECAN, ECONOMONITOR, FanSense, FlexROM, fuzzyLAB, In-Circuit Serial Programming, ICSP, ICEPIC, Migratable Memory, MPASM, MPLIB, MPLINK, MPSIM, PICkit, PICDEM, PICDEM.net, PICLAB, PICTail, PowerCal, PowerInfo, PowerMate, PowerTool, rLAB, rfPICDEM, Select Mode, Smart Serial, SmartTel and Total Endurance are trademarks of Microchip Technology Incorporated in the U.S.A. and other countries.

SQTP is a service mark of Microchip Technology Incorporated in the U.S.A.

All other trademarks mentioned herein are property of their respective companies.

© 2004, Microchip Technology Incorporated, Printed in the U.S.A., All Rights Reserved.

 Printed on recycled paper.

**QUALITY MANAGEMENT SYSTEM  
CERTIFIED BY DNV  
== ISO/TS 16949:2002 ==**

*Microchip received ISO/TS-16949:2002 quality system certification for its worldwide headquarters, design and wafer fabrication facilities in Chandler and Tempe, Arizona and Mountain View, California in October 2003. The Company's quality system processes and procedures are for its PICmicro® 8-bit MCUs, KEELOQ® code hopping devices, Serial EEPROMs, microperipherals, nonvolatile memory and analog products. In addition, Microchip's quality system for the design and manufacture of development systems is ISO 9001:2000 certified.*



## WORLDWIDE SALES AND SERVICE

### AMERICAS

**Corporate Office**  
2355 West Chandler Blvd.  
Chandler, AZ 85224-6199  
Tel: 480-792-7200  
Fax: 480-792-7277  
Technical Support:  
480-792-7627  
Web Address:  
www.microchip.com

#### Atlanta

Alpharetta, GA  
Tel: 770-640-0034  
Fax: 770-640-0307

#### Boston

Westford, MA  
Tel: 978-692-3848  
Fax: 978-692-3821

#### Chicago

Itasca, IL  
Tel: 630-285-0071  
Fax: 630-285-0075

#### Dallas

Addison, TX  
Tel: 972-818-7423  
Fax: 972-818-2924

#### Detroit

Farmington Hills, MI  
Tel: 248-538-2250  
Fax: 248-538-2260

#### Kokomo

Kokomo, IN  
Tel: 765-864-8360  
Fax: 765-864-8387

#### Los Angeles

Mission Viejo, CA  
Tel: 949-462-9523  
Fax: 949-462-9608

#### San Jose

Mountain View, CA  
Tel: 650-215-1444  
Fax: 650-961-0286

#### Toronto

Mississauga, Ontario,  
Canada  
Tel: 905-673-0699  
Fax: 905-673-6509

### ASIA/PACIFIC

**Australia - Sydney**  
Tel: 61-2-9868-6733  
Fax: 61-2-9868-6755

**China - Beijing**  
Tel: 86-10-8528-2100  
Fax: 86-10-8528-2104

**China - Chengdu**  
Tel: 86-28-8676-6200  
Fax: 86-28-8676-6599

**China - Fuzhou**  
Tel: 86-591-750-3506  
Fax: 86-591-750-3521

**China - Hong Kong SAR**  
Tel: 852-2401-1200  
Fax: 852-2401-3431

**China - Shanghai**  
Tel: 86-21-6275-5700  
Fax: 86-21-6275-5060

**China - Shenzhen**  
Tel: 86-755-8290-1380  
Fax: 86-755-8295-1393

**China - Shunde**  
Tel: 86-757-2839-5507  
Fax: 86-757-2839-5571

**China - Qingdao**  
Tel: 86-532-502-7355  
Fax: 86-532-502-7205

### ASIA/PACIFIC

**India - Bangalore**  
Tel: 91-80-2229-0061  
Fax: 91-80-2229-0062

**India - New Delhi**  
Tel: 91-11-5160-8632  
Fax: 91-11-5160-8632

**Japan - Kanagawa**  
Tel: 81-45-471-6166  
Fax: 81-45-471-6122

**Korea - Seoul**  
Tel: 82-2-554-7200  
Fax: 82-2-558-5932 or  
82-2-558-5934

**Singapore**  
Tel: 65-6334-8870  
Fax: 65-6334-8850

**Taiwan - Kaohsiung**  
Tel: 886-7-536-4816  
Fax: 886-7-536-4817

**Taiwan - Taipei**  
Tel: 886-2-2500-6610  
Fax: 886-2-2508-0102

**Taiwan - Hsinchu**  
Tel: 886-3-572-9526  
Fax: 886-3-572-6459

### EUROPE

**Austria - Weis**  
Tel: 43-7242-2244-399  
Fax: 43-7242-2244-393

**Denmark - Ballerup**  
Tel: 45-4420-9895  
Fax: 45-4420-9910

**France - Massy**  
Tel: 33-1-69-53-63-20  
Fax: 33-1-69-30-90-79

**Germany - Ismaning**  
Tel: 49-89-627-144-0  
Fax: 49-89-627-144-44

**Italy - Milan**  
Tel: 39-0331-742611  
Fax: 39-0331-466781

**Netherlands - Drunen**  
Tel: 31-416-690399  
Fax: 31-416-690340

**England - Berkshire**  
Tel: 44-118-921-5869  
Fax: 44-118-921-5820