



# TC4421M/TC4422M

## 9A High-Speed MOSFET Drivers

### Features

- High Peak Output Current: 9A
- Wide Input Supply Voltage Operating Range:
  - 4.5V to 18V
- High Continuous Output Current: 2A Max
- Fast Rise and Fall Times:
  - 30 ns with 4,700 pF Load
  - 180 ns with 47,000 pF Load
- Short Propagation Delays: 30 ns (typ)
- Low Supply Current:
  - With Logic '1' Input – 200  $\mu$ A (typ)
  - With Logic '0' Input – 55  $\mu$ A (typ)
- Low Output Impedance: 1.4 $\Omega$  (typ)
- Latch-Up Protected: Will Withstand 1.5A Output Reverse Current
- Input: Will Withstand Negative Inputs Up To 5V
- Pin-Compatible with the TC4420M/TC4429M 6A MOSFET Driver
- Wide Operating Temperature Range:
  - -55°C to +125°C
- See TC4421/TC4422 Data Sheet (DS21420) for additional temperature range and package offerings

### Applications

- Line Drivers for Extra Heavily-Loaded Lines
- Pulse Generators
- Driving the Largest MOSFETs and IGBTs
- Local Power ON/OFF Switch
- Motor and Solenoid Driver

### General Description

The TC4421M/TC4422M are high-current buffer/drivers capable of driving large MOSFETs and IGBTs.

They are essentially immune to any form of upset, except direct overvoltage or over-dissipation. They cannot be latched, under any conditions, within their power and voltage ratings. These parts are not subject to damage or improper operation when up to 5V of ground bounce is present on their ground terminals. They can accept, without damage or logic upset, more than 1A inductive current of either polarity being forced back into their outputs. In addition, all terminals are fully protected against up to 4 kV of electrostatic discharge.

The TC4421M/TC4422M inputs may be driven directly from either TTL or CMOS (3V to 18V). In addition, 300 mV of hysteresis is built into the input, providing noise immunity and allowing the device to be driven from slowly rising or falling waveforms.

### Package Types

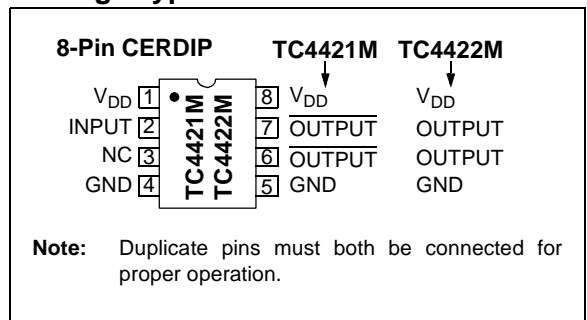

# TC4421M/TC4422M

## Functional Block Diagram

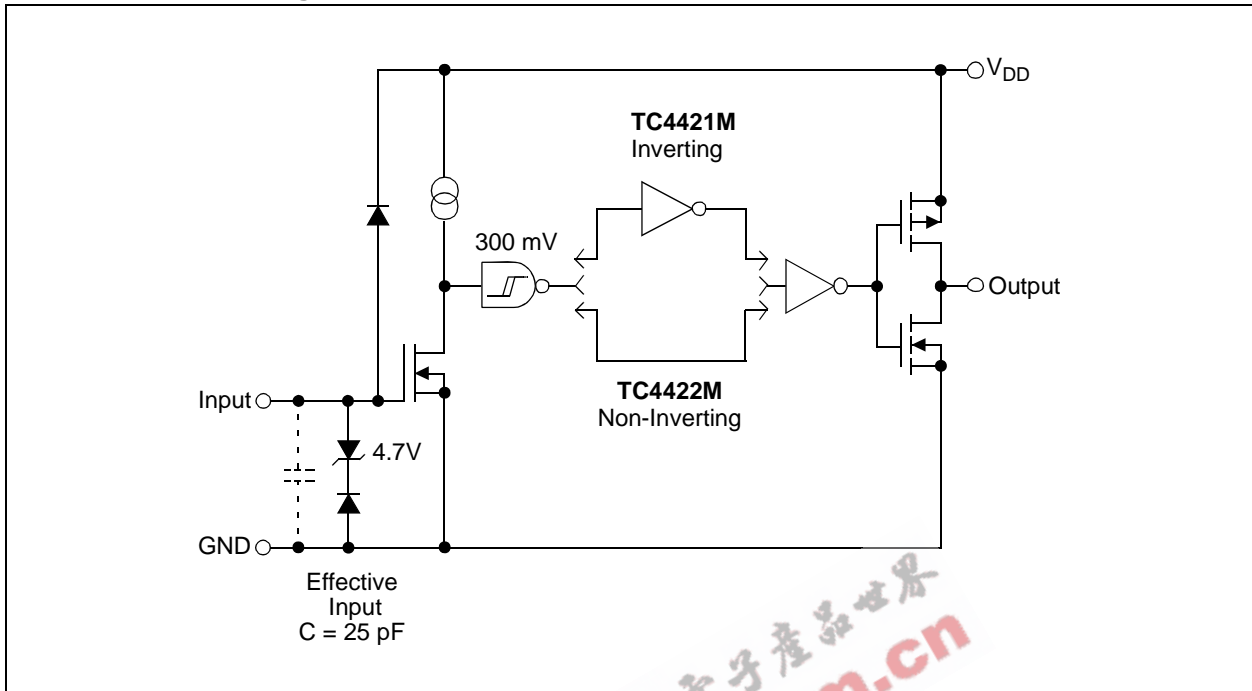

# TC4421M/TC4422M

## 1.0 ELECTRICAL CHARACTERISTICS

### Absolute Maximum Ratings†

Supply Voltage .....	+20V
Input Voltage .....	( $V_{DD} + 0.3V$ ) to (GND – 5V)
Input Current ( $V_{IN} > V_{DD}$ ) .....	50 mA

† Stresses above those listed under “Absolute Maximum Ratings” may cause permanent damage to the device. These are stress ratings only and functional operation of the device at these or any other conditions above those indicated in the operation sections of the specifications is not implied. Exposure to Absolute Maximum Rating conditions for extended periods may affect device reliability.

### DC CHARACTERISTICS

Electrical Specifications: Unless otherwise noted, $T_A = +25^\circ\text{C}$ with $4.5V \leq V_{DD} \leq 18V$ .						
Parameters	Sym	Min	Typ	Max	Units	Conditions
<b>Input</b>						
Logic ‘1’, High Input Voltage	$V_{IH}$	2.4	1.8	—	V	
Logic ‘0’, Low Input Voltage	$V_{IL}$	—	1.3	0.8	V	
Input Current	$I_{IN}$	-10	—	+10	$\mu\text{A}$	$0V \leq V_{IN} \leq V_{DD}$
<b>Output</b>						
High Output Voltage	$V_{OH}$	$V_{DD} - 0.025$	—	—	V	DC TEST
Low Output Voltage	$V_{OL}$	—	—	0.025	V	DC TEST
Output Resistance, High	$R_{OH}$	—	1.4	—	$\Omega$	$I_{OUT} = 10 \text{ mA}$ , $V_{DD} = 18V$
Output Resistance, Low	$R_{OL}$	—	0.9	1.7	$\Omega$	$I_{OUT} = 10 \text{ mA}$ , $V_{DD} = 18V$
Peak Output Current	$I_{PK}$	—	9.0	—	A	$V_{DD} = 18V$
Latch-Up Protection Withstand Reverse Current	$I_{REV}$	—	>1.5	—	A	Duty cycle $\leq 2\%$ , $t \leq 300 \mu\text{sec}$
<b>Switching Time (Note 1)</b>						
Rise Time	$t_R$	—	60	75	ns	Figure 4-1, $C_L = 10,000 \text{ pF}$
Fall Time	$t_F$	—	60	75	ns	Figure 4-1, $C_L = 10,000 \text{ pF}$
Delay Time	$t_{D1}$	—	30	60	ns	Figure 4-1
Delay Time	$t_{D2}$	—	33	60	ns	Figure 4-1
<b>Power Supply</b>						
Power Supply Current	$I_S$	—	0.2	1.5	mA	$V_{IN} = 3V$
		—	55	150	$\mu\text{A}$	$V_{IN} = 0V$
Operating Input Voltage	$V_{DD}$	4.5	—	18	V	

**Note 1:** Switching times ensured by design.

# TC4421M/TC4422M

## DC CHARACTERISTICS (OVER OPERATING TEMPERATURE RANGE)

<b>Electrical Specifications:</b> Unless otherwise noted, over operating temperature range with $4.5V \leq V_{DD} \leq 18V$ .						
Parameters	Sym	Min	Typ	Max	Units	Conditions
<b>Input</b>						
Logic '1', High Input Voltage	$V_{IH}$	2.4	—	—	V	
Logic '0', Low Input Voltage	$V_{IL}$	—	—	0.8	V	
Input Current	$I_{IN}$	-10	—	+10	$\mu A$	$0V \leq V_{IN} \leq V_{DD}$
<b>Output</b>						
High Output Voltage	$V_{OH}$	$V_{DD} - 0.025$	—	—	V	DC TEST
Low Output Voltage	$V_{OL}$	—	—	0.025	V	DC TEST
Output Resistance, High	$R_{OH}$	—	2.4	3.6	$\Omega$	$I_{OUT} = 10 \text{ mA}$ , $V_{DD} = 18V$
Output Resistance, Low	$R_{OL}$	—	1.8	2.7	$\Omega$	$I_{OUT} = 10 \text{ mA}$ , $V_{DD} = 18V$
<b>Switching Time (Note 1)</b>						
Rise Time	$t_R$	—	60	120	ns	Figure 4-1, $C_L = 10,000 \text{ pF}$
Fall Time	$t_F$	—	60	120	ns	Figure 4-1, $C_L = 10,000 \text{ pF}$
Delay Time	$t_{D1}$	—	50	80	ns	Figure 4-1
Delay Time	$t_{D2}$	—	65	80	ns	Figure 4-1
<b>Power Supply</b>						
Power Supply Current	$I_S$	—	—	3	mA	$V_{IN} = 3V$ $V_{IN} = 0V$
Operating Input Voltage	$V_{DD}$	4.5	—	18	V	

**Note 1:** Switching times ensured by design.

## TEMPERATURE CHARACTERISTICS

<b>Electrical Specifications:</b> Unless otherwise noted, all parameters apply with $4.5V \leq V_{DD} \leq 18V$ .						
Parameters	Sym	Min	Typ	Max	Units	Conditions
<b>Temperature Ranges</b>						
Specified Temperature Range (M)	$T_A$	-55	—	+125	$^{\circ}C$	
Maximum Junction Temperature	$T_J$	—	—	+150	$^{\circ}C$	
Storage Temperature Range	$T_A$	-65	—	+150	$^{\circ}C$	
<b>Package Thermal Resistances</b>						
Thermal Resistance, 8L-CERDIP	$\theta_{JA}$	—	150	—	$^{\circ}C/W$	

# TC4421M/TC4422M

## 2.0 TYPICAL PERFORMANCE CURVES

**Note:** The graphs and tables provided following this note are a statistical summary based on a limited number of samples and are provided for informational purposes only. The performance characteristics listed herein are not tested or guaranteed. In some graphs or tables, the data presented may be outside the specified operating range (e.g., outside specified power supply range) and therefore outside the warranted range.

**Note:** Unless otherwise indicated,  $T_A = +25^\circ\text{C}$  with  $4.5\text{V} \leq V_{DD} \leq 18\text{V}$ .

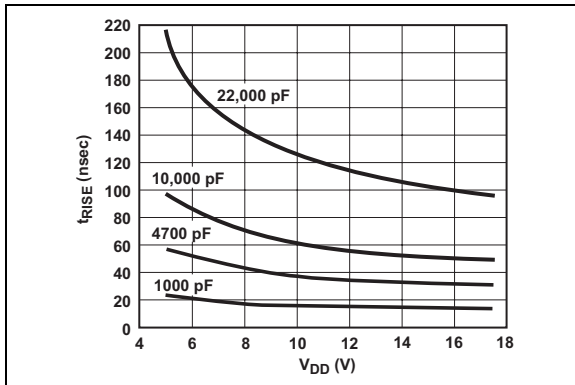

**FIGURE 2-1:** Rise Time vs. Supply Voltage.

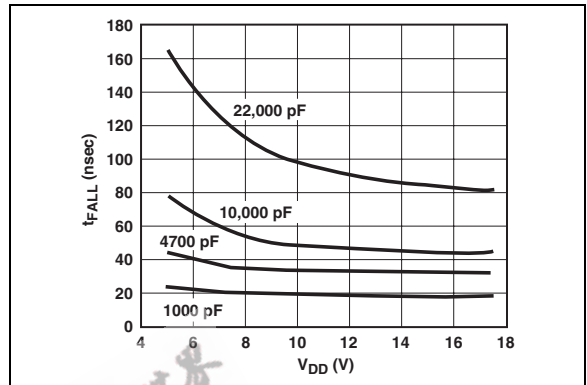

**FIGURE 2-4:** Fall Time vs. Supply Voltage.

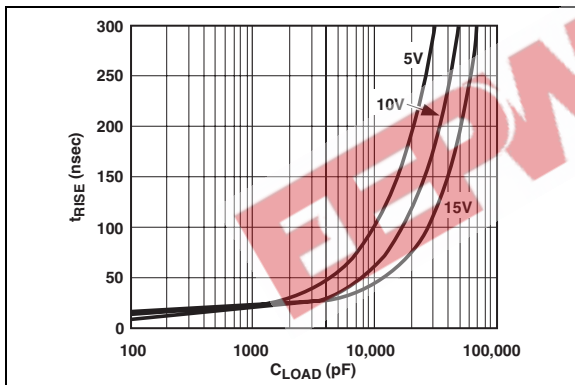

**FIGURE 2-2:** Rise Time vs. Capacitive Load.

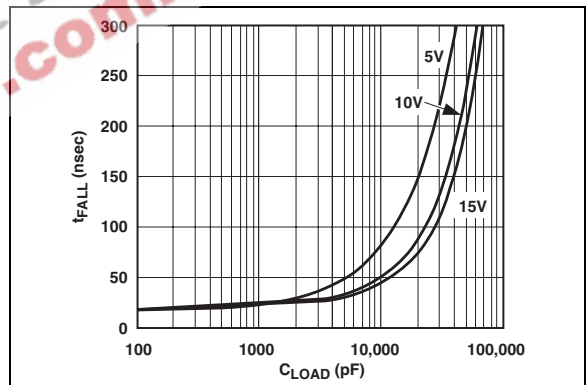

**FIGURE 2-5:** Fall Time vs. Capacitive Load.

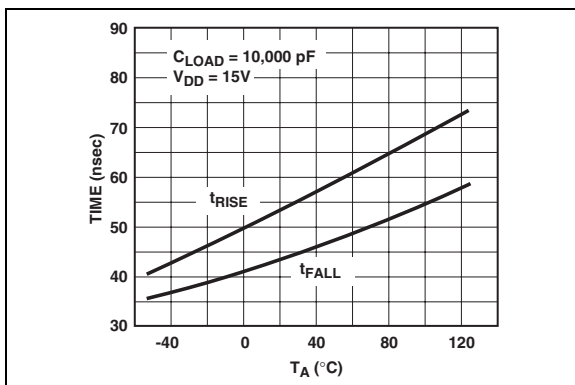

**FIGURE 2-3:** Rise and Fall Times vs. Temperature.

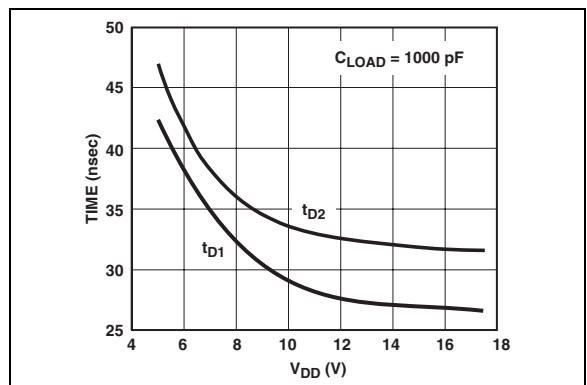

**FIGURE 2-6:** Propagation Delay vs. Supply Voltage.

# TC4421M/TC4422M

**Note:** Unless otherwise indicated,  $T_A = +25^\circ\text{C}$  with  $4.5\text{V} \leq V_{DD} \leq 18\text{V}$ .

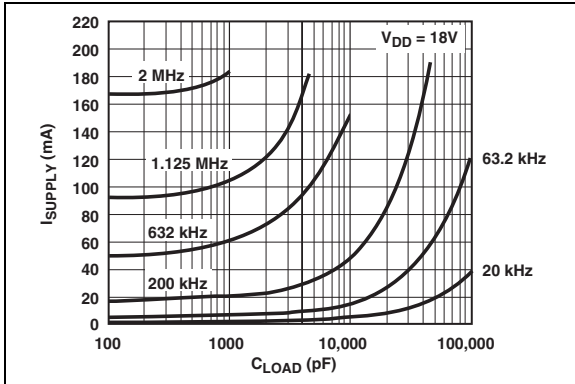

**FIGURE 2-7:** Supply Current vs. Capacitive Load ( $V_{DD} = 18\text{V}$ ).

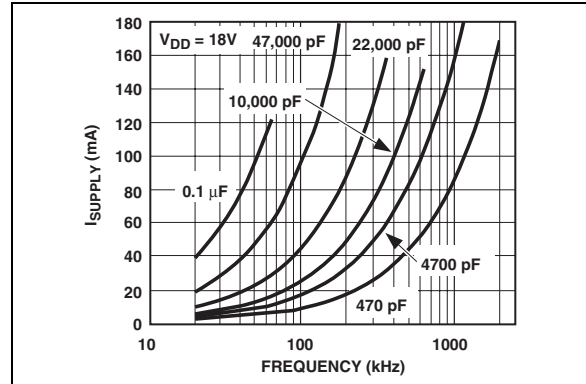

**FIGURE 2-10:** Supply Current vs. Frequency ( $V_{DD} = 18\text{V}$ ).

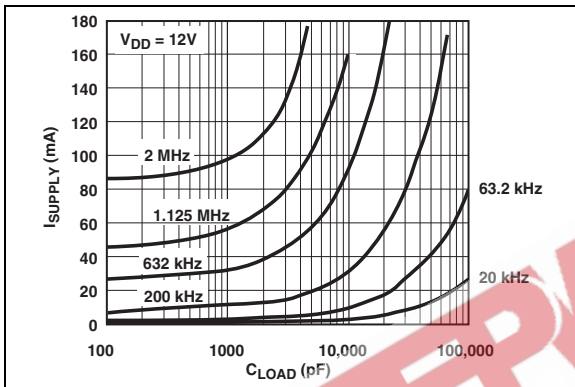

**FIGURE 2-8:** Supply Current vs. Capacitive Load ( $V_{DD} = 12\text{V}$ ).

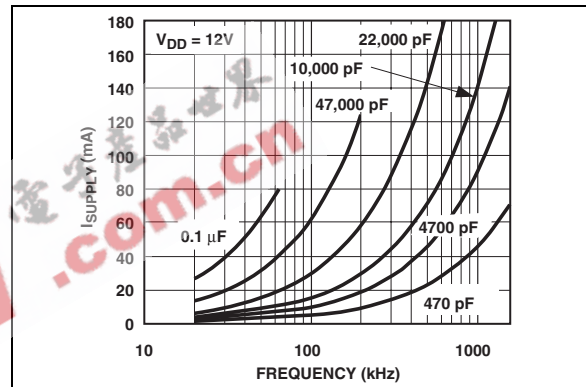

**FIGURE 2-11:** Supply Current vs. Frequency ( $V_{DD} = 12\text{V}$ ).

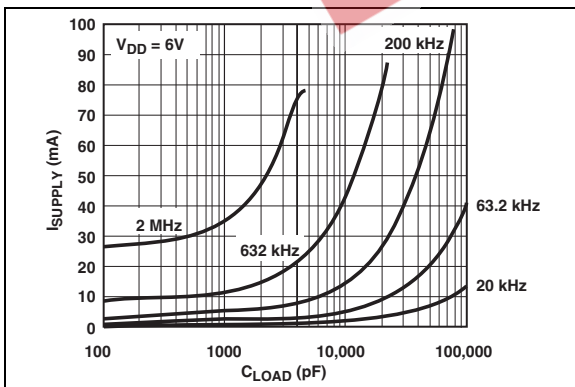

**FIGURE 2-9:** Supply Current vs. Capacitive Load ( $V_{DD} = 6\text{V}$ ).

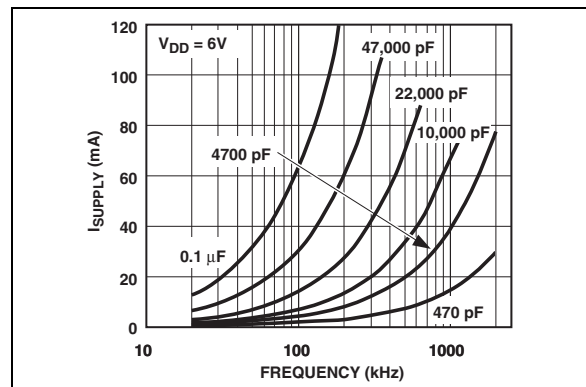

**FIGURE 2-12:** Supply Current vs. Frequency ( $V_{DD} = 6\text{V}$ ).

# TC4421M/TC4422M

**Note:** Unless otherwise indicated,  $T_A = +25^\circ\text{C}$  with  $4.5\text{V} \leq V_{DD} \leq 18\text{V}$ .

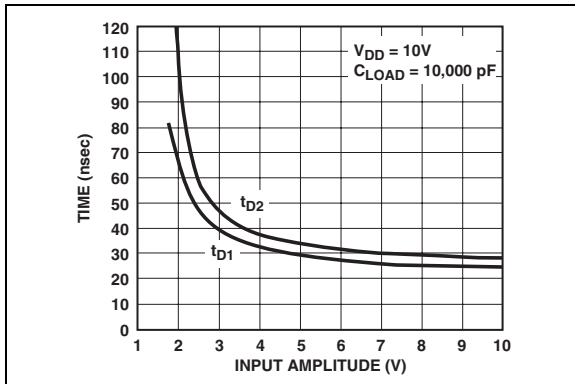

**FIGURE 2-13:** Propagation Delay vs. Input Amplitude.

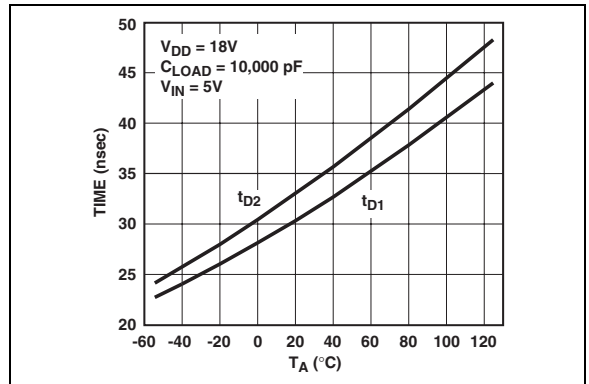

**FIGURE 2-16:** Propagation Delay vs. Temperature.

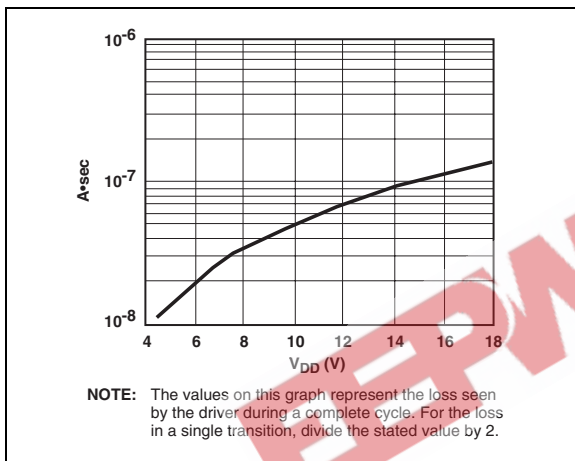

**FIGURE 2-14:** Crossover Energy vs. Supply Voltage.

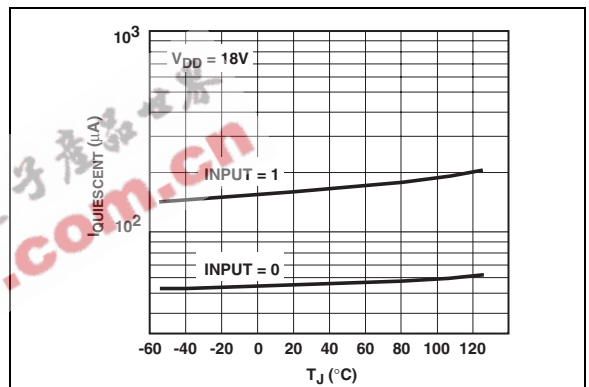

**FIGURE 2-17:** Quiescent Supply Current vs. Temperature.

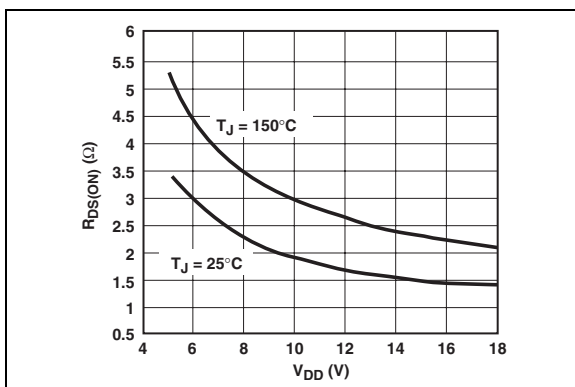

**FIGURE 2-15:** High-State Output Resistance vs. Supply Voltage.

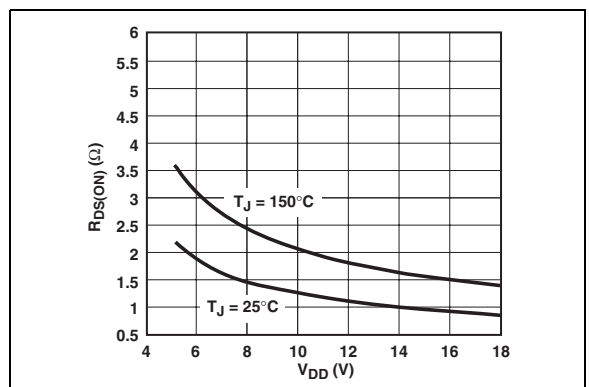

**FIGURE 2-18:** Low-State Output Resistance vs. Supply Voltage.

# TC4421M/TC4422M

## 3.0 PIN DESCRIPTIONS

The descriptions of the pins are listed in Table 3-1.

**TABLE 3-1: PIN FUNCTION TABLE**

Pin No. 8-Pin CERDIP	Symbol	Description
1	V <sub>DD</sub>	Supply input, 4.5V to 18V
2	INPUT	Control input, TTL/CMOS-compatible input
3	NC	No connection
4	GND	Ground
5	GND	Ground
6	OUTPUT	CMOS push-pull output
7	OUTPUT	CMOS push-pull output
8	V <sub>DD</sub>	Supply input, 4.5V to 18V

### 3.1 Supply Input (V<sub>DD</sub>)

The V<sub>DD</sub> input is the bias supply for the MOSFET driver and is rated for 4.5V to 18V with respect to the ground pin. The V<sub>DD</sub> input should be bypassed to ground with a local ceramic capacitor. The value of the capacitor should be chosen based on the capacitive load that is being driven. A minimum value of 1.0  $\mu$ F is suggested.

### 3.2 Control Input

The MOSFET driver input is a high-impedance, TTL/CMOS-compatible input. The input also has 300 mV of hysteresis between the high and low thresholds that prevents output glitching even when the rise and fall time of the input signal is very slow.

### 3.3 CMOS Push-Pull Output

The MOSFET driver output is a low-impedance, CMOS, push-pull style output capable of driving a capacitive load with 9.0A peak currents. The MOSFET driver output is capable of withstanding 1.5A peak reverse currents of either polarity.

### 3.4 Ground

The ground pins are the return path for the bias current and for the high peak currents that discharge the load capacitor. The ground pins should be tied into a ground plane or have very short traces to the bias supply source return.



# TC4421M/TC4422M

## 4.0 APPLICATIONS INFORMATION

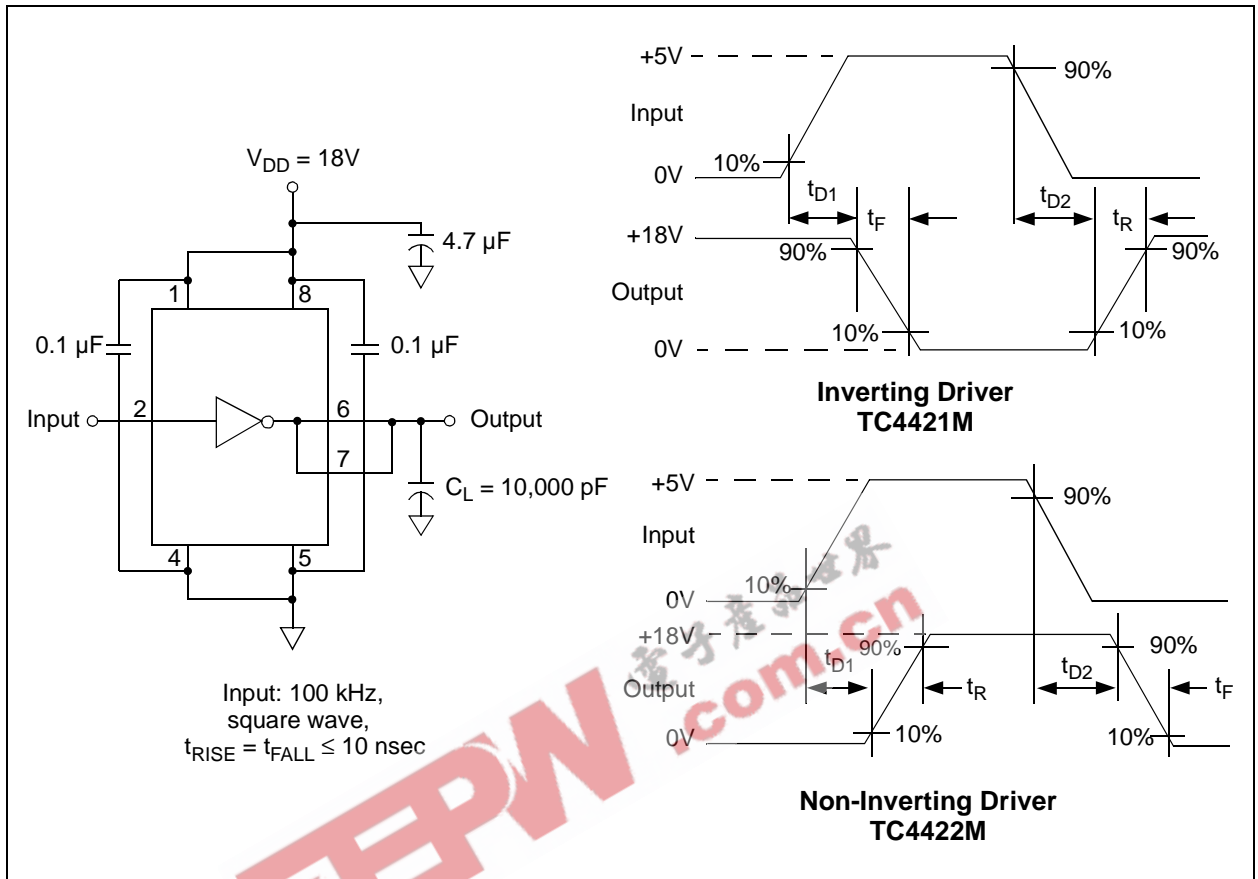

FIGURE 4-1: Switching Time Test Circuits.

# TC4421M/TC4422M

## 5.0 PACKAGING INFORMATION

### 5.1 Package Marking Information

8-Lead CERDIP (300 mil)

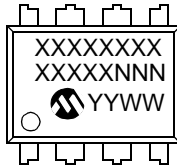

Example:

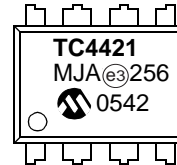

EEPW 电子产品世界  
.com.cn

<b>Legend:</b>	XX...X	Customer-specific information
	Y	Year code (last digit of calendar year)
	YY	Year code (last 2 digits of calendar year)
	WW	Week code (week of January 1 is week '01')
	NNN	Alphanumeric traceability code
	<sup>(e3)</sup>	Pb-free JEDEC designator for Matte Tin (Sn)
	*	This package is Pb-free. The Pb-free JEDEC designator ( <sup>(e3)</sup> ) can be found on the outer packaging for this package.

**Note:** In the event the full Microchip part number cannot be marked on one line, it will be carried over to the next line, thus limiting the number of available characters for customer-specific information.

# TC4421M/TC4422M

## 8-Lead Ceramic Dual In-line – 300 mil (CERDIP)

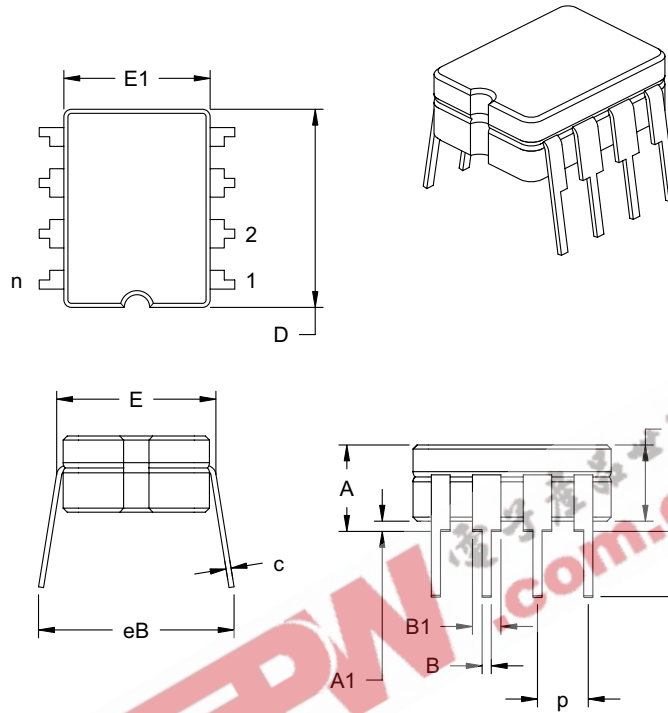

Dimension Limits	Units	INCHES*			MILLIMETERS		
		MIN	NOM	MAX	MIN	NOM	MAX
Number of Pins	n		8			8	
Pitch	p		.100			2.54	
Top to Seating Plane	A	.160	.180	.200	4.06	4.57	5.08
Standoff §	A1	.020	.030	.040	0.51	0.77	1.02
Shoulder to Shoulder Width	E	.290	.305	.320	7.37	7.75	8.13
Ceramic Pkg. Width	E1	.230	.265	.300	5.84	6.73	7.62
Overall Length	D	.370	.385	.400	9.40	9.78	10.16
Tip to Seating Plane	L	.125	.163	.200	3.18	4.13	5.08
Lead Thickness	c	.008	.012	.015	0.20	0.29	0.38
Upper Lead Width	B1	.045	.055	.065	1.14	1.40	1.65
Lower Lead Width	B	.016	.018	.020	0.41	0.46	0.51
Overall Row Spacing	eB	.320	.360	.400	8.13	9.15	10.16

\*Controlling Parameter

JEDEC Equivalent: MS-030

Drawing No. C04-010

# TC4421M/TC4422M

---

NOTES:

EEPW 电子产品世界  
.com.cn

## APPENDIX A: REVISION HISTORY

### Revision A (February 2005)

- Original Release of this Document.

EEPW 电子产品世界  
.com.cn

# TC4421M/TC4422M

---

NOTES:

EEPW 电子产品世界  
.com.cn

# TC4421M/TC4422M

## PRODUCT IDENTIFICATION SYSTEM

To order or obtain information, e.g., on pricing or delivery, refer to the factory or the listed sales office.

<u>PART NO.</u>	<u>XX</u>	<b>Examples:</b>
<b>Device and Temperature Range</b>	<b>Package</b>	a) TC4421MJA: 9A High-Speed MOSFET Driver, Inverting, 8LD CERDIP package. a) TC4422MJA: 9A High-Speed MOSFET Driver, Non-Inverting, 8LD CERDIP package.
Device and Temperature Range:	TC4421M: 9A High-Speed MOSFET Driver, Inverting, -55°C to +125°C TC4422M: 9A High-Speed MOSFET Driver, Non-Inverting, -55°C to +125°C	
Package:	JA = Ceramic Dual In-Line (300 mil Body), 8-lead	

EEPW 电子产品世界 .com.cn

# TC4421M/TC4422M

---

NOTES:

EEPW 电子产品世界  
.com.cn



---

---

**Note the following details of the code protection feature on Microchip devices:**

- Microchip products meet the specification contained in their particular Microchip Data Sheet.
- Microchip believes that its family of products is one of the most secure families of its kind on the market today, when used in the intended manner and under normal conditions.
- There are dishonest and possibly illegal methods used to breach the code protection feature. All of these methods, to our knowledge, require using the Microchip products in a manner outside the operating specifications contained in Microchip's Data Sheets. Most likely, the person doing so is engaged in theft of intellectual property.
- Microchip is willing to work with the customer who is concerned about the integrity of their code.
- Neither Microchip nor any other semiconductor manufacturer can guarantee the security of their code. Code protection does not mean that we are guaranteeing the product as "unbreakable."

Code protection is constantly evolving. We at Microchip are committed to continuously improving the code protection features of our products. Attempts to break Microchip's code protection feature may be a violation of the Digital Millennium Copyright Act. If such acts allow unauthorized access to your software or other copyrighted work, you may have a right to sue for relief under that Act.

---

Information contained in this publication regarding device applications and the like is provided only for your convenience and may be superseded by updates. It is your responsibility to ensure that your application meets with your specifications. MICROCHIP MAKES NO REPRESENTATIONS OR WARRANTIES OF ANY KIND WHETHER EXPRESS OR IMPLIED, WRITTEN OR ORAL, STATUTORY OR OTHERWISE, RELATED TO THE INFORMATION, INCLUDING BUT NOT LIMITED TO ITS CONDITION, QUALITY, PERFORMANCE, MERCHANTABILITY OR FITNESS FOR PURPOSE. Microchip disclaims all liability arising from this information and its use. Use of Microchip's products as critical components in life support systems is not authorized except with express written approval by Microchip. No licenses are conveyed, implicitly or otherwise, under any Microchip intellectual property rights.

#### Trademarks

The Microchip name and logo, the Microchip logo, Accuron, dsPIC, KEELoC, microID, MPLAB, PIC, PICmicro, PICSTART, PRO MATE, PowerSmart, rfPIC, and SmartShunt are registered trademarks of Microchip Technology Incorporated in the U.S.A. and other countries.

AmpLab, FilterLab, Migratable Memory, MXDEV, MXLAB, PICMASTER, SEEVAL, SmartSensor and The Embedded Control Solutions Company are registered trademarks of Microchip Technology Incorporated in the U.S.A.

Analog-for-the-Digital Age, Application Maestro, dsPICDEM, dsPICDEM.net, dsPICworks, ECAN, ECONOMONITOR, FanSense, FlexROM, fuzzyLAB, In-Circuit Serial Programming, ICSP, ICEPIC, MPASM, MPLIB, MPLINK, MPSIM, PICkit, PICDEM, PICDEM.net, PICLAB, PICtail, PowerCal, PowerInfo, PowerMate, PowerTool, rfLAB, rfPICDEM, Select Mode, Smart Serial, SmartTel, Total Endurance and WiperLock are trademarks of Microchip Technology Incorporated in the U.S.A. and other countries.

SQTP is a service mark of Microchip Technology Incorporated in the U.S.A.

All other trademarks mentioned herein are property of their respective companies.

© 2005, Microchip Technology Incorporated, Printed in the U.S.A., All Rights Reserved.

 Printed on recycled paper.

**QUALITY MANAGEMENT SYSTEM**  
**CERTIFIED BY DNV**  
**== ISO/TS 16949:2002 ==**

*Microchip received ISO/TS-16949:2002 quality system certification for its worldwide headquarters, design and wafer fabrication facilities in Chandler and Tempe, Arizona and Mountain View, California in October 2003. The Company's quality system processes and procedures are for its PICmicro® 8-bit MCUs, KEELoC® code hopping devices, Serial EEPROMs, microperipherals, nonvolatile memory and analog products. In addition, Microchip's quality system for the design and manufacture of development systems is ISO 9001:2000 certified.*



## WORLDWIDE SALES AND SERVICE

### AMERICAS

**Corporate Office**  
2355 West Chandler Blvd.  
Chandler, AZ 85224-6199  
Tel: 480-792-7200  
Fax: 480-792-7277  
Technical Support:  
<http://support.microchip.com>  
Web Address:  
[www.microchip.com](http://www.microchip.com)

#### Atlanta

Alpharetta, GA  
Tel: 770-640-0034  
Fax: 770-640-0307

#### Boston

Westford, MA  
Tel: 978-692-3848  
Fax: 978-692-3821

#### Chicago

Itasca, IL  
Tel: 630-285-0071  
Fax: 630-285-0075

#### Dallas

Addison, TX  
Tel: 972-818-7423  
Fax: 972-818-2924

#### Detroit

Farmington Hills, MI  
Tel: 248-538-2250  
Fax: 248-538-2260

#### Kokomo

Kokomo, IN  
Tel: 765-864-8360  
Fax: 765-864-8387

#### Los Angeles

Mission Viejo, CA  
Tel: 949-462-9523  
Fax: 949-462-9608

#### San Jose

Mountain View, CA  
Tel: 650-215-1444  
Fax: 650-961-0286

#### Toronto

Mississauga, Ontario,  
Canada  
Tel: 905-673-0699  
Fax: 905-673-6509

### ASIA/PACIFIC

**Australia - Sydney**  
Tel: 61-2-9868-6733  
Fax: 61-2-9868-6755

**China - Beijing**  
Tel: 86-10-8528-2100  
Fax: 86-10-8528-2104

**China - Chengdu**  
Tel: 86-28-8676-6200  
Fax: 86-28-8676-6599

**China - Fuzhou**  
Tel: 86-591-8750-3506  
Fax: 86-591-8750-3521

**China - Hong Kong SAR**  
Tel: 852-2401-1200  
Fax: 852-2401-3431

**China - Shanghai**  
Tel: 86-21-5407-5533  
Fax: 86-21-5407-5066

**China - Shenyang**  
Tel: 86-24-2334-2829  
Fax: 86-24-2334-2393

**China - Shenzhen**  
Tel: 86-755-8203-2660  
Fax: 86-755-8203-1760

**China - Shunde**  
Tel: 86-757-2839-5507  
Fax: 86-757-2839-5571

**China - Qingdao**  
Tel: 86-532-502-7355  
Fax: 86-532-502-7205

### ASIA/PACIFIC

**India - Bangalore**  
Tel: 91-80-2229-0061  
Fax: 91-80-2229-0062

**India - New Delhi**  
Tel: 91-11-5160-8631  
Fax: 91-11-5160-8632

**Japan - Kanagawa**  
Tel: 81-45-471-6166  
Fax: 81-45-471-6122

**Korea - Seoul**  
Tel: 82-2-554-7200  
Fax: 82-2-558-5932 or  
82-2-558-5934

**Singapore**  
Tel: 65-6334-8870  
Fax: 65-6334-8850

**Taiwan - Kaohsiung**  
Tel: 886-7-536-4818  
Fax: 886-7-536-4803

**Taiwan - Taipei**  
Tel: 886-2-2500-6610  
Fax: 886-2-2508-0102

**Taiwan - Hsinchu**  
Tel: 886-3-572-9526  
Fax: 886-3-572-6459

### EUROPE

**Austria - Weis**  
Tel: 43-7242-2244-399  
Fax: 43-7242-2244-393

**Denmark - Ballerup**  
Tel: 45-4450-2828  
Fax: 45-4485-2829

**France - Massy**  
Tel: 33-1-69-53-63-20  
Fax: 33-1-69-30-90-79

**Germany - Ismaning**  
Tel: 49-89-627-144-0  
Fax: 49-89-627-144-44

**Italy - Milan**  
Tel: 39-0331-742611  
Fax: 39-0331-466781

**Netherlands - Druen**  
Tel: 31-416-690399  
Fax: 31-416-690340

**England - Berkshire**  
Tel: 44-118-921-5869  
Fax: 44-118-921-5820