



# MICROCHIP TC4423/TC4424/TC4425

## 3A Dual High-Speed Power MOSFET Drivers

### Features

- High Peak Output Current: 3A
- Wide Input Supply Voltage Operating Range:
  - 4.5V to 18V
- High Capacitive Load Drive Capability:
  - 1800 pF in 25 ns
- Short Delay Times: <40 ns (typ)
- Matched Rise/Fall Times
- Low Supply Current:
  - With Logic '1' Input – 3.5 mA (Max)
  - With Logic '0' Input – 350  $\mu$ A (Max)
- Low Output Impedance: 3.5 $\Omega$  (typ)
- Latch-Up Protected: Will Withstand 1.5A Reverse Current
- Logic Input Will Withstand Negative Swing Up To 5V
- ESD Protected: 4 kV
- Pin compatible with the TC1426/TC1427/TC1428, TC4426/TC4427/TC4428 and TC4426A/TC4427A/TC4428A devices.
- Space-saving 8-Pin 6x5 DFN Package

### General Description

The TC4423/TC4424/TC4425 devices are a family of 3A, dual-output buffers/MOSFET drivers. Pin compatible with the TC1426/27/28, TC4426/27/28 and TC4426A/27A/28A dual 1.5A driver families, the TC4423/24/25 family has an increased latch-up current rating of 1.5A, making them even more robust for operation in harsh electrical environments.

As MOSFET drivers, the TC4423/TC4424/TC4425 can easily charge 1800 pF gate capacitance in under 35 nsec, providing low enough impedances in both the on and off states to ensure the MOSFET's intended state will not be affected, even by large transients.

The TC4423/TC4424/TC4425 inputs may be driven directly from either TTL or CMOS (2.4V to 18V). In addition, the 300 mV of built-in hysteresis provides noise immunity and allows the device to be driven from slowly rising or falling waveforms.

### Applications

- Switch Mode Power Supplies
- Pulse Transformer Drive
- Line Drivers

### Package Types<sup>(1)</sup>

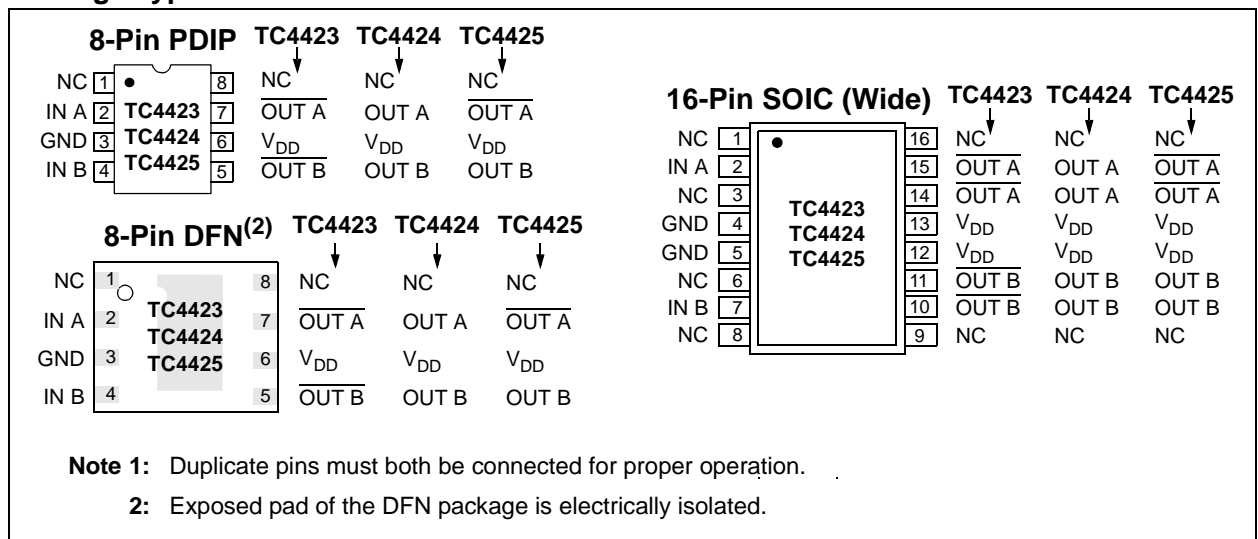

# TC4423/TC4424/TC4425

## Functional Block Diagram<sup>(1)</sup>

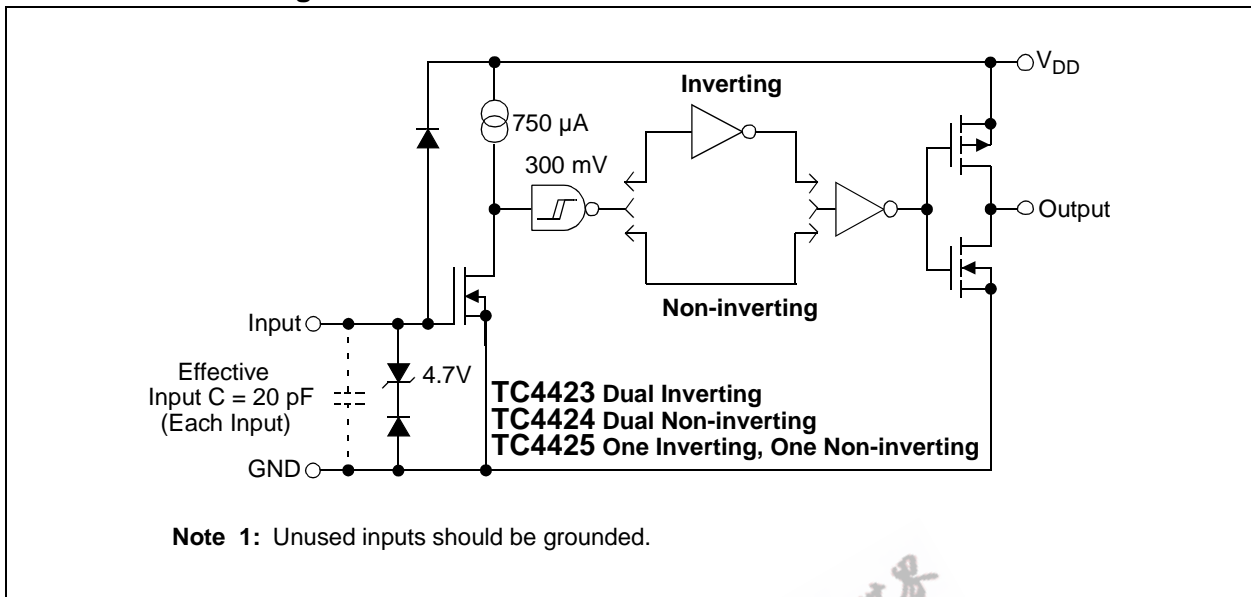

EEPW.com.cn 电子产品世界

# TC4423/TC4424/TC4425

## 1.0 ELECTRICAL CHARACTERISTICS

### Absolute Maximum Ratings †

Supply Voltage .....	+22V
Input Voltage, IN A or IN B .....	( $V_{DD} + 0.3V$ ) to (GND – 5V)
Package Power Dissipation ( $T_A \leq 70^\circ C$ )	
DFN .....	<b>Note 2</b>
PDIP .....	730 mW
SOIC .....	470 mW

† **Notice:** Stresses above those listed under "Maximum Ratings" may cause permanent damage to the device. This is a stress rating only and functional operation of the device at those or any other conditions above those indicated in the operational sections of this specification is not intended. Exposure to maximum rating conditions for extended periods may affect device reliability.

### DC CHARACTERISTICS

Electrical Specifications: Unless otherwise indicated, $T_A = +25^\circ C$ , with $4.5V \leq V_{DD} \leq 18V$ .						
Parameters	Sym	Min	Typ	Max	Units	Conditions
<b>Input</b>						
Logic '1', High Input Voltage	$V_{IH}$	2.4	—	—	V	
Logic '0', Low Input Voltage	$V_{IL}$	—	—	0.8	V	
Input Current	$I_{IN}$	-1	—	1	$\mu A$	$0V \leq V_{IN} \leq V_{DD}$
<b>Output</b>						
High Output Voltage	$V_{OH}$	$V_{DD} - 0.025$	—	—	V	
Low Output Voltage	$V_{OL}$	—	—	0.025	V	
Output Resistance, High	$R_{OH}$	—	2.8	5	$\Omega$	$I_{OUT} = 10\text{ mA}$ , $V_{DD} = 18V$
Output Resistance, Low	$R_{OL}$	—	3.5	5	$\Omega$	$I_{OUT} = 10\text{ mA}$ , $V_{DD} = 18V$
Peak Output Current	$I_{PK}$	—	3	—	A	
Latch-Up Protection Withstand Reverse Current	$I_{REV}$	—	>1.5	—	A	Duty cycle $\leq 2\%$ , $t \leq 300\ \mu\text{sec}$ .
<b>Switching Time (Note 1)</b>						
Rise Time	$t_R$	—	23	35	ns	Figure 4-1, Figure 4-2, $C_L = 1800\text{ pF}$
Fall Time	$t_F$	—	25	35	ns	Figure 4-1, Figure 4-2, $C_L = 1800\text{ pF}$
Delay Time	$t_{D1}$	—	33	75	ns	Figure 4-1, Figure 4-2, $C_L = 1800\text{ pF}$
Delay Time	$t_{D2}$	—	38	75	ns	Figure 4-1, Figure 4-2, $C_L = 1800\text{ pF}$
<b>Power Supply</b>						
Power Supply Current	$I_S$	—	1.5	2.5	mA	$V_{IN} = 3V$ (Both inputs)
		—	0.15	0.25		$V_{IN} = 0V$ (Both inputs)

**Note 1:** Switching times ensured by design.

**2:** Package power dissipation is dependent on the copper pad area on the PCB.

# TC4423/TC4424/TC4425

## DC CHARACTERISTICS (OVER OPERATING TEMPERATURE RANGE)

Electrical Specifications: Unless otherwise indicated, operating temperature range with $4.5V \leq V_{DD} \leq 18V$ .						
Parameters	Sym	Min	Typ	Max	Units	Conditions
<b>Input</b>						
Logic '1', High Input Voltage	$V_{IH}$	2.4	—	—	V	
Logic '0', Low Input Voltage	$V_{IL}$	—	—	0.8	V	
Input Current	$I_{IN}$	-10	—	+10	$\mu A$	$0V \leq V_{IN} \leq V_{DD}$
<b>Output</b>						
High Output Voltage	$V_{OH}$	$V_{DD} - 0.025$	—	—	V	
Low Output Voltage	$V_{OL}$	—	—	0.025	V	
Output Resistance, High	$R_{OH}$	—	3.7	8	$\Omega$	$I_{OUT} = 10 \text{ mA}, V_{DD} = 18V$
Output Resistance, Low	$R_{OL}$	—	4.3	8	$\Omega$	$I_{OUT} = 10 \text{ mA}, V_{DD} = 18V$
Peak Output Current	$I_{PK}$	—	3.0	—	A	
Latch-Up Protection Withstand Reverse Current	$I_{REV}$	—	>1.5	—	A	Duty cycle $\leq 2\%$ , $t \leq 300 \mu\text{sec}$
<b>Switching Time (Note 1)</b>						
Rise Time	$t_R$	—	28	60	ns	Figure 4-1, Figure 4-2, $C_L = 1800 \text{ pF}$
Fall Time	$t_F$	—	32	60	ns	Figure 4-1, Figure 4-2, $C_L = 1800 \text{ pF}$
Delay Time	$t_{D1}$	—	32	100	ns	Figure 4-1, Figure 4-2, $C_L = 1800 \text{ pF}$
Delay Time	$t_{D2}$	—	38	100	ns	Figure 4-1, Figure 4-2, $C_L = 1800 \text{ pF}$
<b>Power Supply</b>						
Power Supply Current	$I_S$	—	2.0	3.5	mA	$V_{IN} = 3V$ (Both inputs) $V_{IN} = 0V$ (Both inputs)

Note 1: Switching times ensured by design.

## TEMPERATURE CHARACTERISTICS

Electrical Specifications: Unless otherwise noted, all parameters apply with $4.5V \leq V_{DD} \leq 18V$ .						
Parameters	Sym	Min	Typ	Max	Units	Conditions
<b>Temperature Ranges</b>						
Specified Temperature Range (C)	$T_A$	0	—	+70	$^{\circ}C$	
Specified Temperature Range (E)	$T_A$	-40	—	+85	$^{\circ}C$	
Specified Temperature Range (V)	$T_A$	-40	—	+125	$^{\circ}C$	
Maximum Junction Temperature	$T_J$	—	—	+150	$^{\circ}C$	
Storage Temperature Range	$T_A$	-65	—	+150	$^{\circ}C$	
<b>Package Thermal Resistances</b>						
Thermal Resistance, 8L-6x5 DFN	$\theta_{JA}$	—	33.2	—	$^{\circ}C/W$	Typical four-layer board with vias to ground plane
Thermal Resistance, 8L-PDIP	$\theta_{JA}$	—	125	—	$^{\circ}C/W$	
Thermal Resistance, 16L-SOIC	$\theta_{JA}$	—	155	—	$^{\circ}C/W$	

# TC4423/TC4424/TC4425

## 2.0 TYPICAL PERFORMANCE CURVES

**Note:** The graphs and tables provided following this note are a statistical summary based on a limited number of samples and are provided for informational purposes only. The performance characteristics listed herein are not tested or guaranteed. In some graphs or tables, the data presented may be outside the specified operating range (e.g., outside specified power supply range) and therefore outside the warranted range.

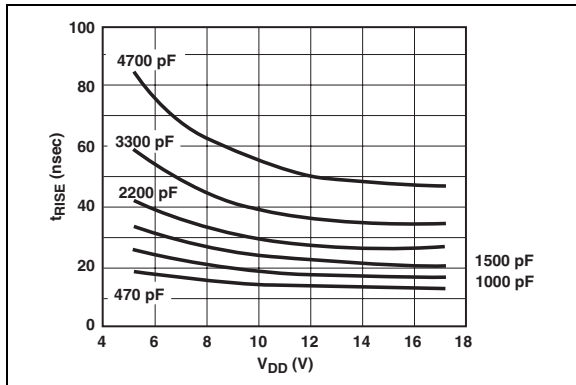

**FIGURE 2-1:** Rise Time vs. Supply Voltage.

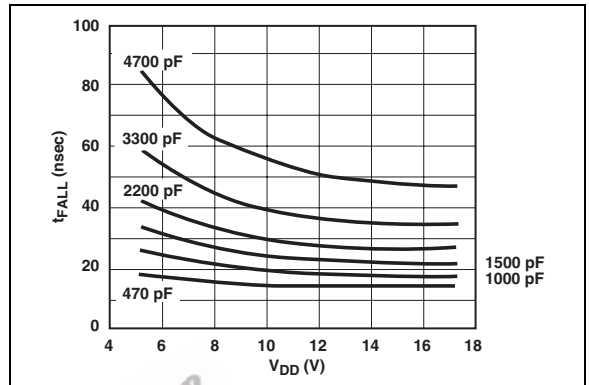

**FIGURE 2-4:** Fall Time vs. Supply Voltage.

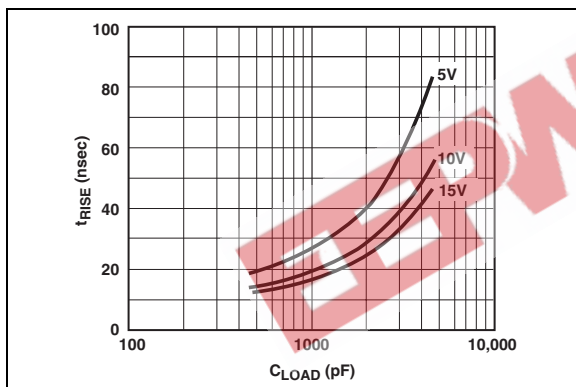

**FIGURE 2-2:** Rise Time vs. Capacitive Load.

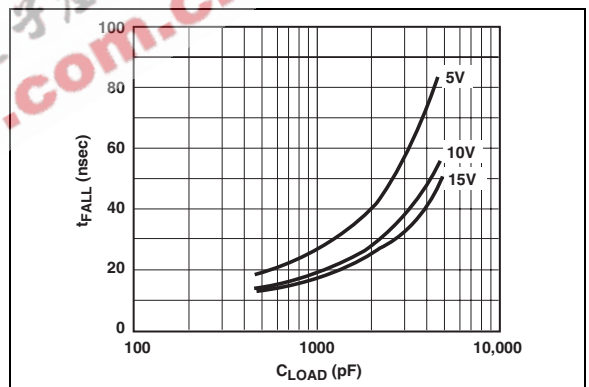

**FIGURE 2-5:** Fall Time vs. Capacitive Load.

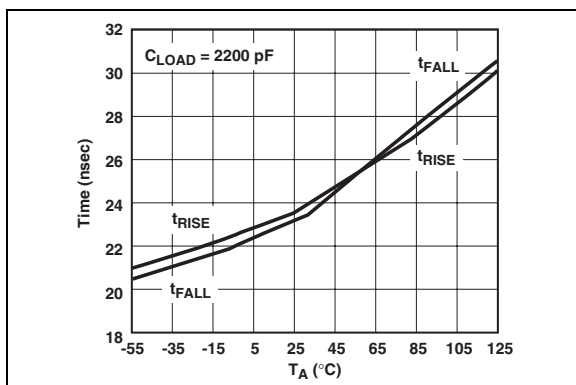

**FIGURE 2-3:** Rise and Fall Times vs. Temperature.

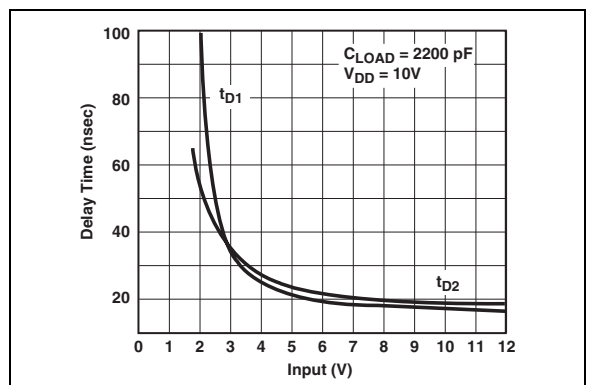

**FIGURE 2-6:** Propagation Delay vs. Input Amplitude.

# TC4423/TC4424/TC4425

## Typical Performance Curves (Continued)

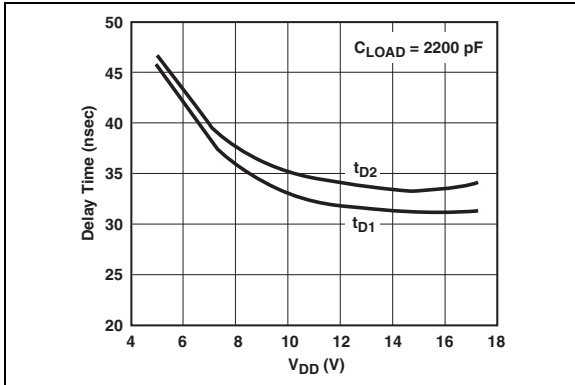

**FIGURE 2-7:** Propagation Delay Time vs. Supply Voltage.

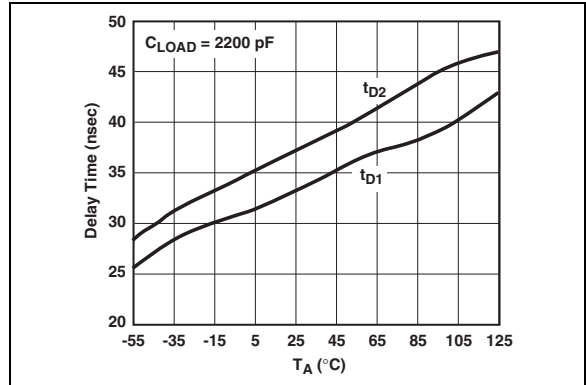

**FIGURE 2-10:** Propagation Delay Time vs. Temperature.

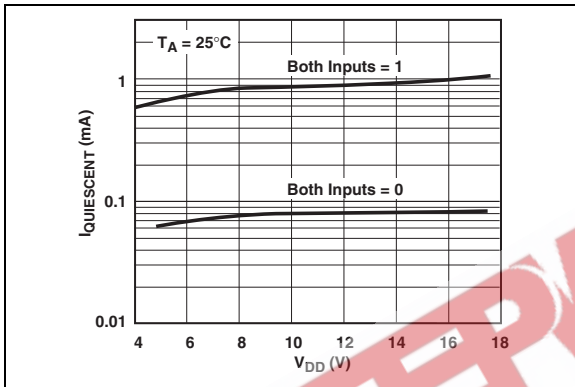

**FIGURE 2-8:** Quiescent Current vs. Supply Voltage.

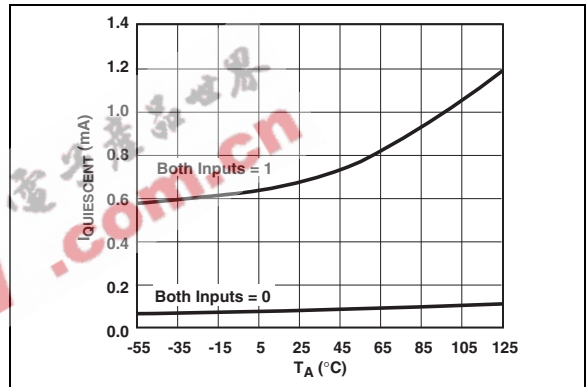

**FIGURE 2-11:** Quiescent Current vs. Temperature.

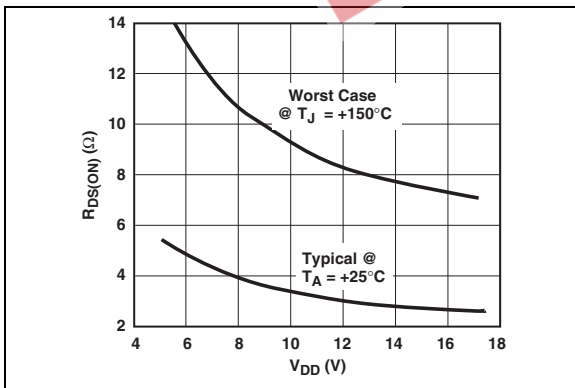

**FIGURE 2-9:** Output Resistance (Output High) vs. Supply Voltage.

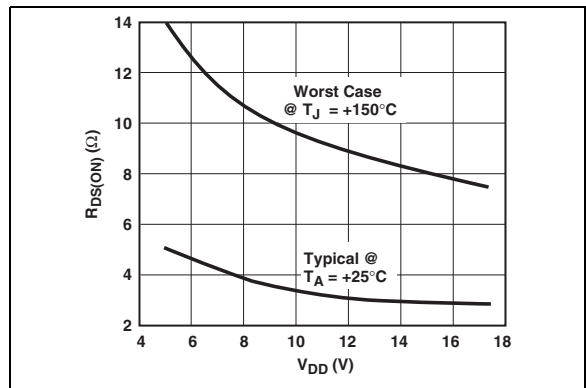
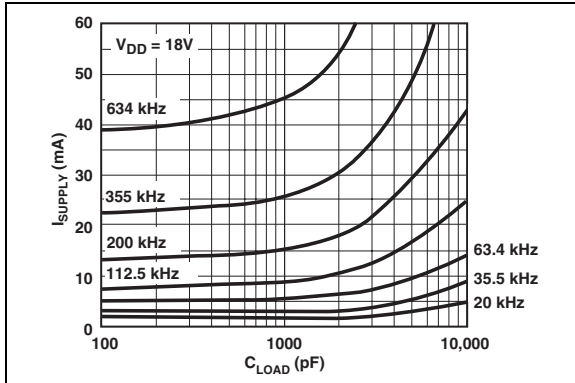

**FIGURE 2-12:** Output Resistance (Output Low) vs. Supply Voltage.

# TC4423/TC4424/TC4425

## Typical Performance Curves (Continued)

Note: Load on single output only



**FIGURE 2-13:** Supply Current vs. Capacitive Load.

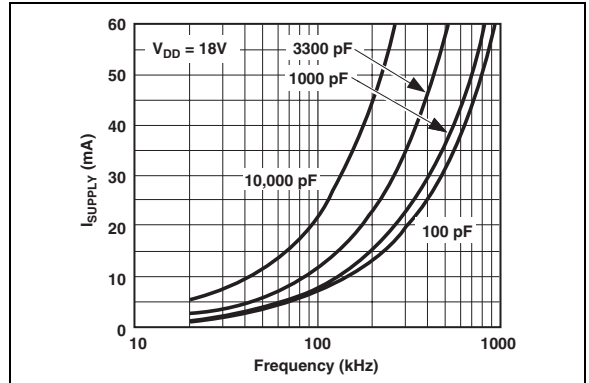

**FIGURE 2-16:** Supply Current vs. Frequency.

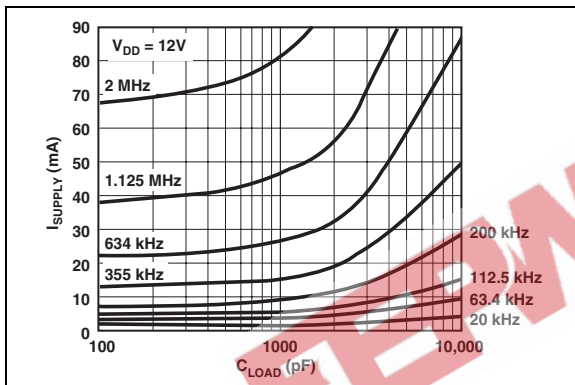

**FIGURE 2-14:** Supply Current vs. Capacitive Load.

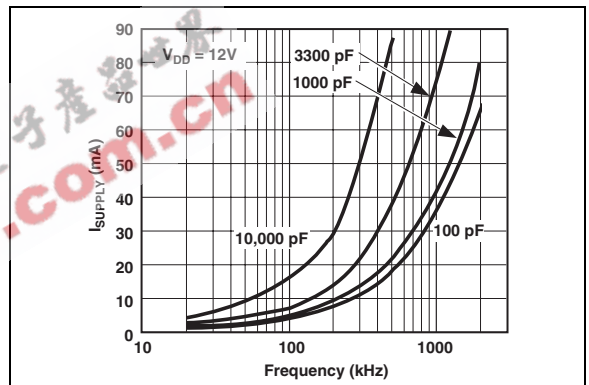

**FIGURE 2-17:** Supply Current vs. Frequency.

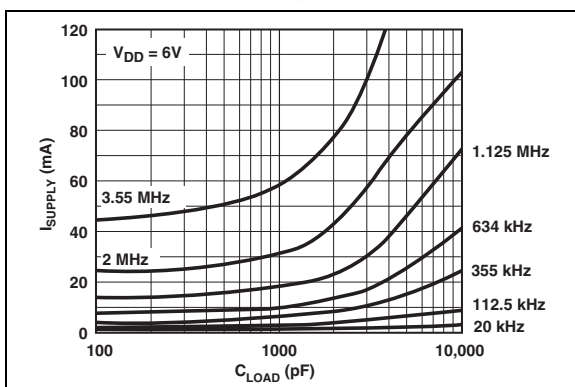

**FIGURE 2-15:** Supply Current vs. Capacitive Load.

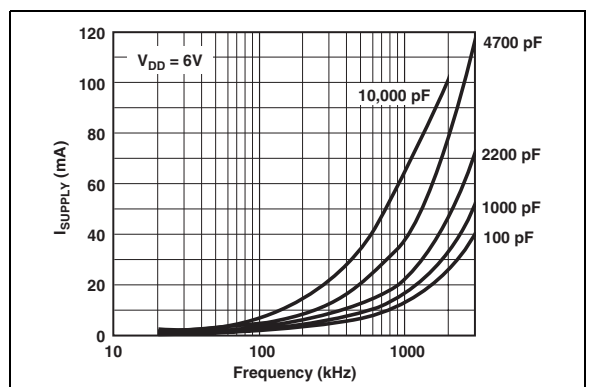

**FIGURE 2-18:** Supply Current vs. Frequency.

# TC4423/TC4424/TC4425

## Typical Performance Curves (Continued)

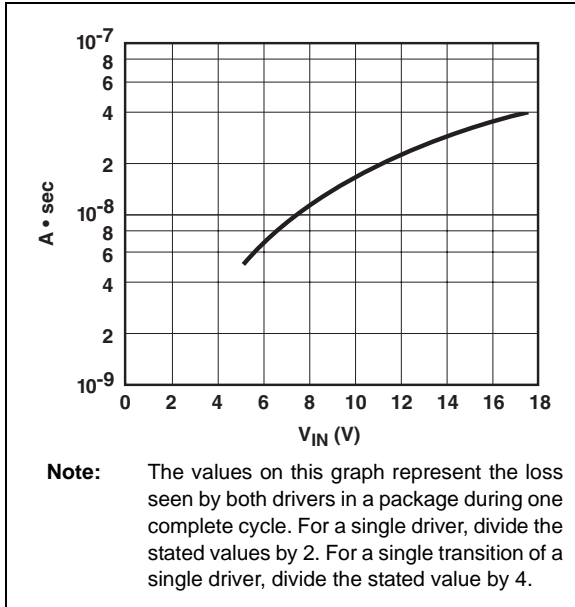

FIGURE 2-19: TC4423 Crossover Energy.

EEPW 电子产品世界 .com.cn



# TC4423/TC4424/TC4425

## 3.0 PIN DESCRIPTIONS

The descriptions of the pins are listed in Table 3-1.

TABLE 3-1: PIN FUNCTION TABLE <sup>(1)</sup>

8-Pin PDIP	8-Pin DFN	16-Pin SOIC (Wide)	Symbol	Description
1	1	1	NC	No connection
2	2	2	IN A	Input A
—	—	3	NC	No connection
3	3	4	GND	Ground
—	—	5	GND	Ground
—	—	6	NC	No connection
4	4	7	IN B	Input B
—	—	8	NC	No connection
—	—	9	NC	No connection
5	5	10	OUT B	Output B
—	—	11	OUT B	Output B
6	6	12	V <sub>DD</sub>	Supply input
—	—	13	V <sub>DD</sub>	Supply input
7	7	14	OUT A	Output A
—	—	15	OUT A	Output A
8	8	16	NC	No connection
—	PAD	—	NC	Exposed Metal Pad

**Note 1:** Duplicate pins must be connected for proper operation.

### 3.1 Inputs A and B

Inputs A and B are TTL/CMOS compatible inputs that control outputs A and B, respectively. These inputs have 300 mV of hysteresis between the high and low input levels, allowing them to be driven from slow rising and falling signals, and to provide noise immunity.

### 3.2 Outputs A and B

Outputs A and B are CMOS push-pull outputs that are capable of sourcing and sinking 3A peaks of current (V<sub>DD</sub> = 18V). The low output impedance ensures the gate of the external MOSFET will stay in the intended state even during large transients. These outputs also have a reverse current latch-up rating of 1.5A.

### 3.3 Supply Input (V<sub>DD</sub>)

V<sub>DD</sub> is the bias supply input for the MOSFET driver and has a voltage range of 4.5V to 18V. This input must be decoupled to ground with a local ceramic capacitor. This bypass capacitor provides a localized low-impedance path for the peak currents that are to be provided to the load.

### 3.4 Ground (GND)

Ground is the device return pin. The ground pin(s) should have a low-impedance connection to the bias supply source return. High peak currents will flow out the ground pin(s) when the capacitive load is being discharged.

### 3.5 Exposed Metal Pad

The exposed metal pad of the 6x5 DFN package is not internally connected to any potential. Therefore, this pad can be connected to a ground plane or other copper plane on a printed circuit board to aid in heat removal from the package.

# TC4423/TC4424/TC4425

## 4.0 APPLICATIONS INFORMATION

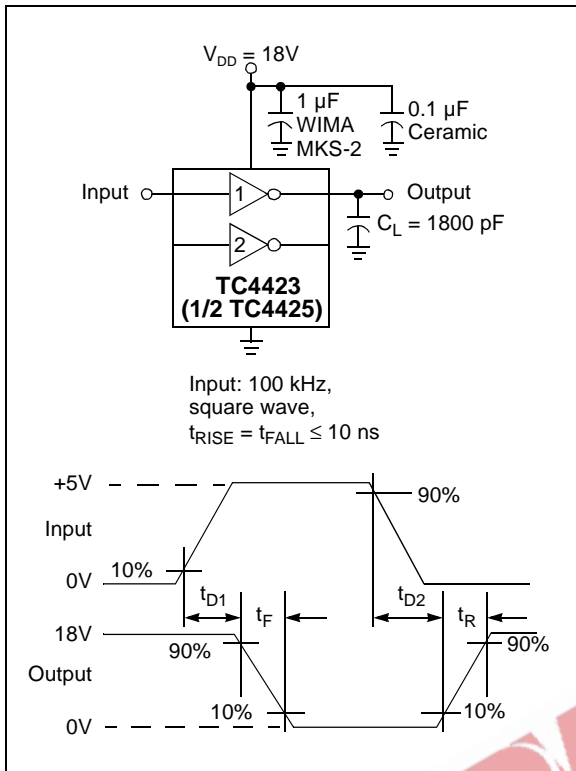

**FIGURE 4-1:** Inverting Driver Switching Time.

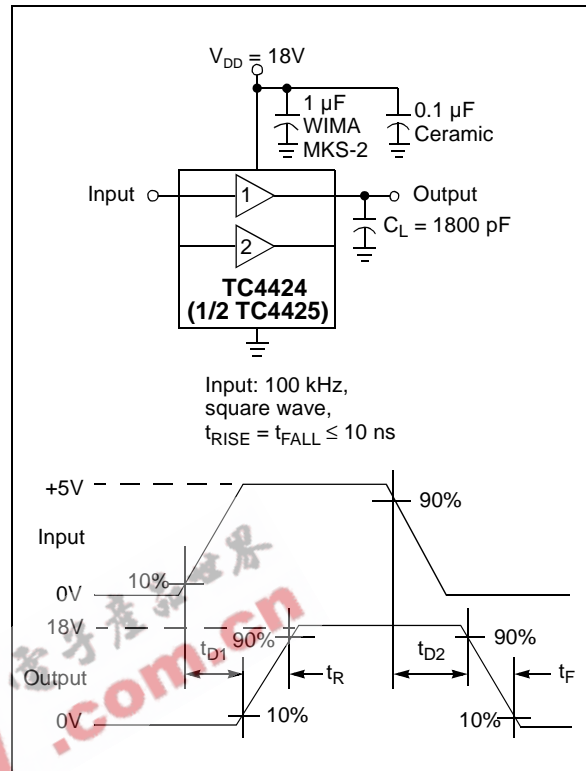

**FIGURE 4-2:** Non-inverting Driver Switching Time.

# TC4423/TC4424/TC4425

## 5.0 PACKAGING INFORMATION

### 5.1 Package Marking Information

8-Lead DFN

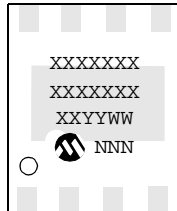

Example:

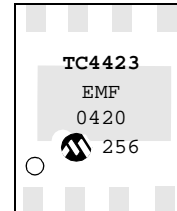

8-Lead PDIP (300 mil)

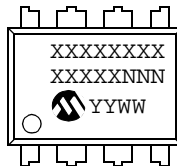

Example:



16-Lead SOIC (300 mil)

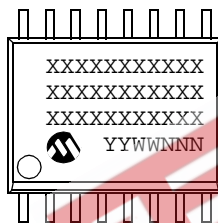

Example:

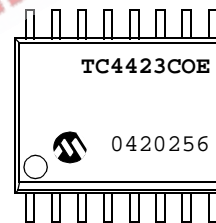

<b>Legend:</b>	XX...X	Customer specific information*
	YY	Year code (last 2 digits of calendar year)
	WW	Week code (week of January 1 is week '01')
	NNN	Alphanumeric traceability code
<b>Note:</b>	In the event the full Microchip part number cannot be marked on one line, it will be carried over to the next line thus limiting the number of available characters for customer specific information.	

\* Standard marking consists of Microchip part number, year code, week code, traceability code (facility code, mask rev#, and assembly code). For marking beyond this, certain price adders apply. Please check with your Microchip Sales Office.

# TC4423/TC4424/TC4425

## 8-Lead Plastic Dual Flat No Lead Package (MF) 6x5 mm Body (DFN-S) – Saw Singulated

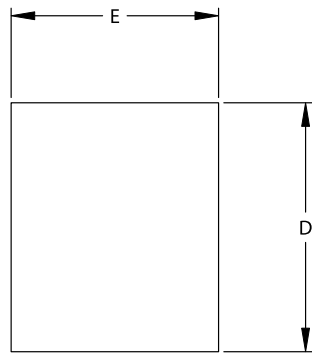

TOP VIEW

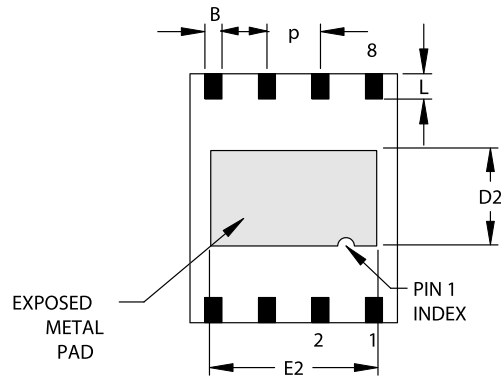

BOTTOM VIEW

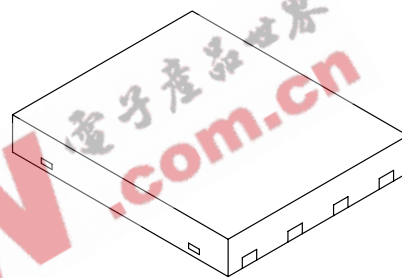
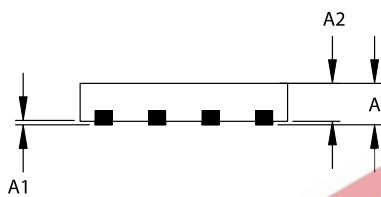

Dimension Limits	Units	INCHES			MILLIMETERS*		
		MIN	NOM	MAX	MIN	NOM	MAX
Number of Pins	n		8			8	
Pitch	P	.050 BSC			1.27 BSC		
Overall Height	A	.033	.035	.037	0.85	0.90	0.95
Package Thickness	A2	.031	.035	.037	0.80	0.89	0.95
Standoff	A1	.000	.0004	.002	0.00	0.01	0.05
Base Thickness	A3	.007	.008	.009	0.17	0.20	0.23
Overall Length	E	.195	.197	.199	4.95	5.00	5.05
Exposed Pad Length	E2	.152	.157	.163	3.85	4.00	4.15
Overall Width	D	.234	.236	.238	5.95	6.00	6.05
Exposed Pad Width	D2	.089	.091	.093	2.25	2.30	2.35
Lead Width	B	.014	.016	.019	0.35	0.40	0.47
Lead Length	L	.024		.026	0.60		0.65

Notes:

JEDEC equivalent: MO-220

Drawing No. C04-122

Revised 11/3/03

# TC4423/TC4424/TC4425

## 8-Lead Plastic Dual In-line (P) – 300 mil (PDIP)

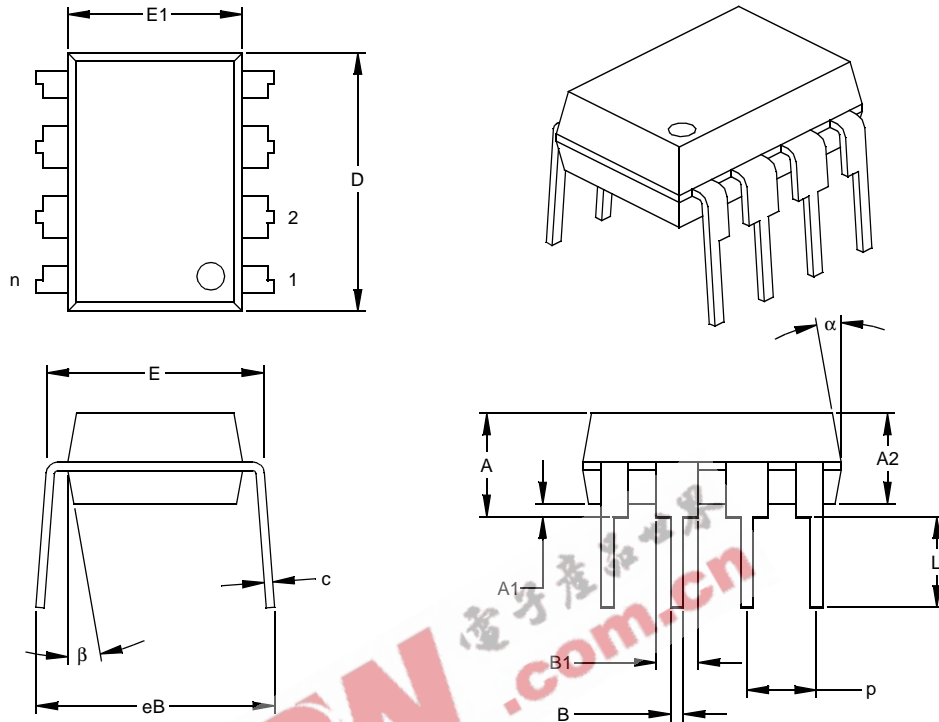

Dimension	Units	INCHES*			MILLIMETERS		
		MIN	NOM	MAX	MIN	NOM	MAX
Number of Pins	n		8			8	
Pitch	P		.100			2.54	
Top to Seating Plane	A	.140	.155	.170	3.56	3.94	4.32
Molded Package Thickness	A2	.115	.130	.145	2.92	3.30	3.68
Base to Seating Plane	A1	.015			0.38		
Shoulder to Shoulder Width	E	.300	.313	.325	7.62	7.94	8.26
Molded Package Width	E1	.240	.250	.260	6.10	6.35	6.60
Overall Length	D	.360	.373	.385	9.14	9.46	9.78
Tip to Seating Plane	L	.125	.130	.135	3.18	3.30	3.43
Lead Thickness	c	.008	.012	.015	0.20	0.29	0.38
Upper Lead Width	B1	.045	.058	.070	1.14	1.46	1.78
Lower Lead Width	B	.014	.018	.022	0.36	0.46	0.56
Overall Row Spacing	§ eB	.310	.370	.430	7.87	9.40	10.92
Mold Draft Angle Top	α	5	10	15	5	10	15
Mold Draft Angle Bottom	β	5	10	15	5	10	15

\* Controlling Parameter  
 § Significant Characteristic

Notes:  
 Dimensions D and E1 do not include mold flash or protrusions. Mold flash or protrusions shall not exceed .010" (0.254mm) per side.  
 JEDEC Equivalent: MS-001  
 Drawing No. C04-018

# TC4423/TC4424/TC4425

16-Lead Plastic Small Outline (SO) – Wide, 300 mil (SOIC)

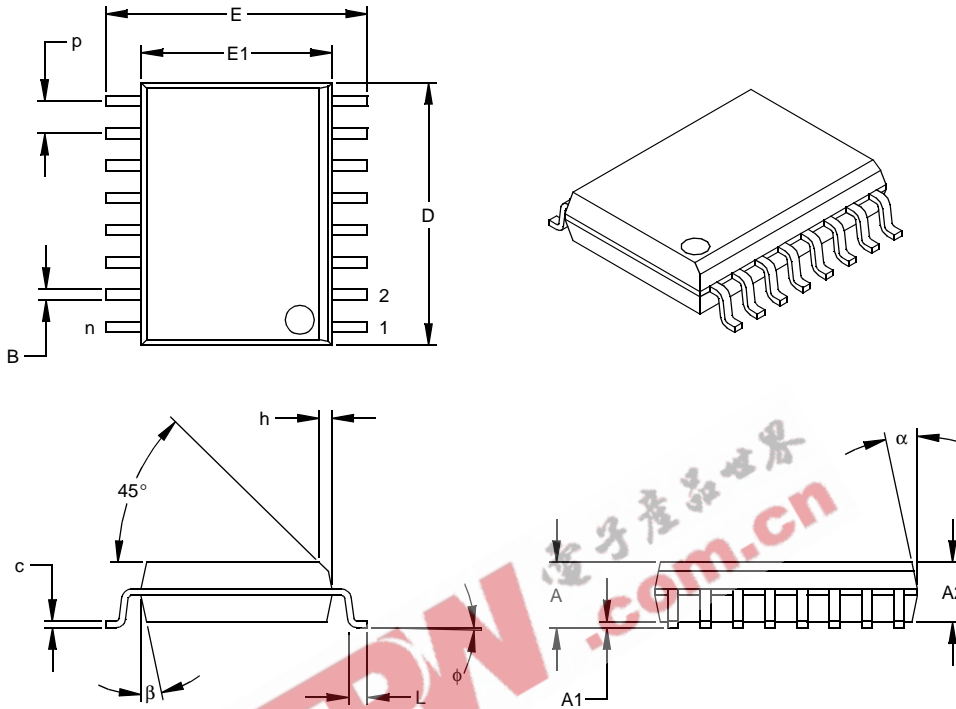

Dimension	Units	INCHES*			MILLIMETERS		
		MIN	NOM	MAX	MIN	NOM	MAX
Number of Pins	n		16			16	
Pitch	p		.050			1.27	
Overall Height	A	.093	.099	.104	2.36	2.50	2.64
Molded Package Thickness	A2	.088	.091	.094	2.24	2.31	2.39
Standoff §	A1	.004	.008	.012	0.10	0.20	0.30
Overall Width	E	.394	.407	.420	10.01	10.34	10.67
Molded Package Width	E1	.291	.295	.299	7.39	7.49	7.59
Overall Length	D	.398	.406	.413	10.10	10.30	10.49
Chamfer Distance	h	.010	.020	.029	0.25	0.50	0.74
Foot Length	L	.016	.033	.050	0.41	0.84	1.27
Foot Angle	φ	0	4	8	0	4	8
Lead Thickness	c	.009	.011	.013	0.23	0.28	0.33
Lead Width	B	.014	.017	.020	0.36	0.42	0.51
Mold Draft Angle Top	α	0	12	15	0	12	15
Mold Draft Angle Bottom	β	0	12	15	0	12	15

\* Controlling Parameter  
§ Significant Characteristic

Notes:  
Dimensions D and E1 do not include mold flash or protrusions. Mold flash or protrusions shall not exceed .010" (0.254mm) per side.  
JEDEC Equivalent: MS-013  
Drawing No. C04-102

# TC4423/TC4424/TC4425

## PRODUCT IDENTIFICATION SYSTEM

To order or obtain information, e.g., on pricing or delivery, refer to the factory or the listed sales office.

<u>PART NO.</u>	<u>X</u>	<u>XX</u>	<u>XXX</u>	<u>X</u>	<b>Examples:</b>
Device	Temperature Range	Package	Tape & Reel	PB Free	
<b>Device:</b> TC4423: 3A Dual MOSFET Driver, Inverting TC4424: 3A Dual MOSFET Driver, Non-Inverting TC4425: 3A Dual MOSFET Driver, Complementary	<b>Temperature Range:</b> C = 0°C to +70°C (PDIP & SOIC Only) E = -40°C to +85°C V = -40°C to +125°C	<b>Package:</b> MF = Dual, Flat, No-Lead (6x5 mm Body), 8-lead MF713 = Dual, Flat, No-Lead (6x5 mm Body), 8-lead (Tape and Reel) OE = SOIC (Wide), 16-pin OE713 = SOIC (Wide), 16-pin (Tape and Reel) PA = Plastic DIP, (300 mil body), 8-lead		<b>PB Free:</b> G = Lead-Free device * = Blank  * Available on selected packages. Contact your local sales representative for availability.	a) TC4423COE: 3A Dual Inverting MOSFET Driver, 0°C to +70°C, 16LD SOIC package.  b) TC4423CPA: 3A Dual Inverting MOSFET Driver, 0°C to +70°C, 8LD PDIP package.  c) TC4423VMF: 3A Dual Inverting MOSFET Driver, -40°C to +125°C, 8LD DFN package.  a) TC4424COE713: 3A Dual Non-Inverting, MOSFET Driver, 0°C to +70°C, 16LD SOIC package, Tape and Reel.  b) TC4424EPA: 3A Dual Non-Inverting, MOSFET Driver, -40°C to +85°C, 8LD PDIP package.  a) TC4425EOE: 3A Dual Complementary, MOSFET Driver, -40°C to +85°C, 16LD SOIC package.  b) TC4425CPA: 3A Dual Complementary, MOSFET Driver, 0°C to +70°C, PDIP package.

## Sales and Support

### Data Sheets

Products supported by a preliminary Data Sheet may have an errata sheet describing minor operational differences and recommended workarounds. To determine if an errata sheet exists for a particular device, please contact one of the following:

1. Your local Microchip sales office
2. The Microchip Corporate Literature Center U.S. FAX: (480) 792-7277
3. The Microchip Worldwide Site ([www.microchip.com](http://www.microchip.com))

Please specify which device, revision of silicon and Data Sheet (include Literature #) you are using.

### Customer Notification System

Register on our web site ([www.microchip.com/cn](http://www.microchip.com/cn)) to receive the most current information on our products.

# TC4423/TC4424/TC4425

---

NOTES:

EEPW 电子产品世界  
.com.cn



---

---

**Note the following details of the code protection feature on Microchip devices:**

- Microchip products meet the specification contained in their particular Microchip Data Sheet.
- Microchip believes that its family of products is one of the most secure families of its kind on the market today, when used in the intended manner and under normal conditions.
- There are dishonest and possibly illegal methods used to breach the code protection feature. All of these methods, to our knowledge, require using the Microchip products in a manner outside the operating specifications contained in Microchip's Data Sheets. Most likely, the person doing so is engaged in theft of intellectual property.
- Microchip is willing to work with the customer who is concerned about the integrity of their code.
- Neither Microchip nor any other semiconductor manufacturer can guarantee the security of their code. Code protection does not mean that we are guaranteeing the product as "unbreakable."

Code protection is constantly evolving. We at Microchip are committed to continuously improving the code protection features of our products. Attempts to break Microchip's code protection feature may be a violation of the Digital Millennium Copyright Act. If such acts allow unauthorized access to your software or other copyrighted work, you may have a right to sue for relief under that Act.

---

Information contained in this publication regarding device applications and the like is intended through suggestion only and may be superseded by updates. It is your responsibility to ensure that your application meets with your specifications. No representation or warranty is given and no liability is assumed by Microchip Technology Incorporated with respect to the accuracy or use of such information, or infringement of patents or other intellectual property rights arising from such use or otherwise. Use of Microchip's products as critical components in life support systems is not authorized except with express written approval by Microchip. No licenses are conveyed, implicitly or otherwise, under any intellectual property rights.

#### Trademarks

The Microchip name and logo, the Microchip logo, Accuron, dsPIC, KEELOQ, microID, MPLAB, PIC, PICmicro, PICSTART, PRO MATE, PowerSmart, rfPIC, and SmartShunt are registered trademarks of Microchip Technology Incorporated in the U.S.A. and other countries.

AmpLab, FilterLab, MXDEV, MXLAB, PICMASTER, SEEVAL, SmartSensor and The Embedded Control Solutions Company are registered trademarks of Microchip Technology Incorporated in the U.S.A.

Analog-for-the-Digital Age, Application Maestro, dsPICDEM, dsPICDEM.net, dsPICworks, ECAN, ECONOMONITOR, FanSense, FlexROM, fuzzyLAB, In-Circuit Serial Programming, ICSP, ICEPIC, Migratable Memory, MPASM, MPLIB, MPLINK, MPSIM, PICKit, PICDEM, PICDEM.net, PICLAB, PICTail, PowerCal, PowerInfo, PowerMate, PowerTool, rLAB, rfPICDEM, Select Mode, Smart Serial, SmartTel and Total Endurance are trademarks of Microchip Technology Incorporated in the U.S.A. and other countries.

SQTP is a service mark of Microchip Technology Incorporated in the U.S.A.

All other trademarks mentioned herein are property of their respective companies.

© 2004, Microchip Technology Incorporated, Printed in the U.S.A., All Rights Reserved.

 Printed on recycled paper.

**QUALITY MANAGEMENT SYSTEM  
CERTIFIED BY DNV  
== ISO/TS 16949:2002 ==**

*Microchip received ISO/TS-16949:2002 quality system certification for its worldwide headquarters, design and wafer fabrication facilities in Chandler and Tempe, Arizona and Mountain View, California in October 2003. The Company's quality system processes and procedures are for its PICmicro® 8-bit MCUs, KEELOQ® code hopping devices, Serial EEPROMs, microperipherals, nonvolatile memory and analog products. In addition, Microchip's quality system for the design and manufacture of development systems is ISO 9001:2000 certified.*



## WORLDWIDE SALES AND SERVICE

### AMERICAS

**Corporate Office**  
2355 West Chandler Blvd.  
Chandler, AZ 85224-6199  
Tel: 480-792-7200  
Fax: 480-792-7277  
Technical Support:  
480-792-7627  
Web Address:  
www.microchip.com

#### Atlanta

Alpharetta, GA  
Tel: 770-640-0034  
Fax: 770-640-0307

#### Boston

Westford, MA  
Tel: 978-692-3848  
Fax: 978-692-3821

#### Chicago

Itasca, IL  
Tel: 630-285-0071  
Fax: 630-285-0075

#### Dallas

Addison, TX  
Tel: 972-818-7423  
Fax: 972-818-2924

#### Detroit

Farmington Hills, MI  
Tel: 248-538-2250  
Fax: 248-538-2260

#### Kokomo

Kokomo, IN  
Tel: 765-864-8360  
Fax: 765-864-8387

#### Los Angeles

Mission Viejo, CA  
Tel: 949-462-9523  
Fax: 949-462-9608

#### San Jose

Mountain View, CA  
Tel: 650-215-1444  
Fax: 650-961-0286

#### Toronto

Mississauga, Ontario,  
Canada  
Tel: 905-673-0699  
Fax: 905-673-6509

### ASIA/PACIFIC

**Australia - Sydney**  
Tel: 61-2-9868-6733  
Fax: 61-2-9868-6755

**China - Beijing**  
Tel: 86-10-8528-2100  
Fax: 86-10-8528-2104

**China - Chengdu**  
Tel: 86-28-8676-6200  
Fax: 86-28-8676-6599

**China - Fuzhou**  
Tel: 86-591-750-3506  
Fax: 86-591-750-3521

#### China - Hong Kong SAR

Tel: 852-2401-1200  
Fax: 852-2401-3431

#### China - Shanghai

Tel: 86-21-6275-5700  
Fax: 86-21-6275-5060

**China - Shenzhen**  
Tel: 86-755-8290-1380  
Fax: 86-755-8295-1393

**China - Shunde**  
Tel: 86-757-2839-5507  
Fax: 86-757-2839-5571

**China - Qingdao**  
Tel: 86-532-502-7355  
Fax: 86-532-502-7205

### ASIA/PACIFIC

**India - Bangalore**  
Tel: 91-80-2229-0061  
Fax: 91-80-2229-0062

**India - New Delhi**  
Tel: 91-11-5160-8632  
Fax: 91-11-5160-8632

**Japan - Kanagawa**  
Tel: 81-45-471-6166  
Fax: 81-45-471-6122

**Korea - Seoul**  
Tel: 82-2-554-7200  
Fax: 82-2-558-5932 or  
82-2-558-5934

**Singapore**  
Tel: 65-6334-8870  
Fax: 65-6334-8850

**Taiwan - Kaohsiung**  
Tel: 886-7-536-4816  
Fax: 886-7-536-4817

**Taiwan - Taipei**  
Tel: 886-2-2500-6610  
Fax: 886-2-2508-0102

**Taiwan - Hsinchu**  
Tel: 886-3-572-9526  
Fax: 886-3-572-6459

### EUROPE

**Austria - Weis**  
Tel: 43-7242-2244-399  
Fax: 43-7242-2244-393

**Denmark - Ballerup**  
Tel: 45-4420-9895  
Fax: 45-4420-9910

**France - Massy**  
Tel: 33-1-69-53-63-20  
Fax: 33-1-69-30-90-79

**Germany - Ismaning**  
Tel: 49-89-627-144-0  
Fax: 49-89-627-144-44

**Italy - Milan**  
Tel: 39-0331-742611  
Fax: 39-0331-466781

**Netherlands - Druen**  
Tel: 31-416-690399  
Fax: 31-416-690340

**England - Berkshire**  
Tel: 44-118-921-5869  
Fax: 44-118-921-5820