

12W AUDIO AMPLIFIER

DESCRIPTION

The TDA2006 is a monolithic integrated circuit in Pentawatt package, intended for use as a low frequency class "AB" amplifier. At $\pm 12V$, $d = 10\%$ typically it provides 12W output power on a 4Ω load and 8W on a 8Ω . The TDA2006 provides high output current and has very low harmonic and cross-over distortion. Further the device incorporates an original (and patented) short circuit protection system comprising an arrangement for automatically limiting the dissipated power so as to keep the working point of the output transistors within their safe operating area. A conventional thermal shutdown system is also included. The TDA2006 is pin to pin equivalent to the TDA2030.

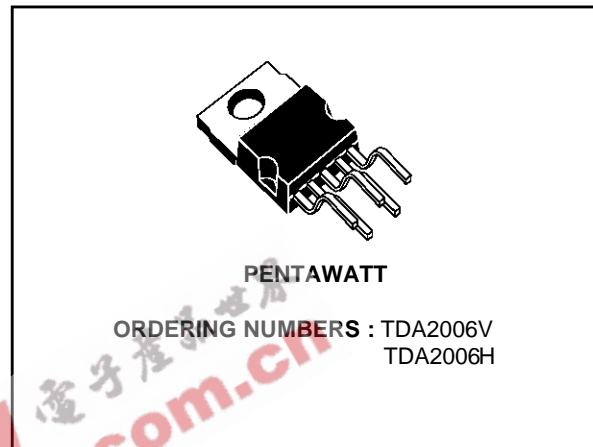

TYPICAL APPLICATION CIRCUIT

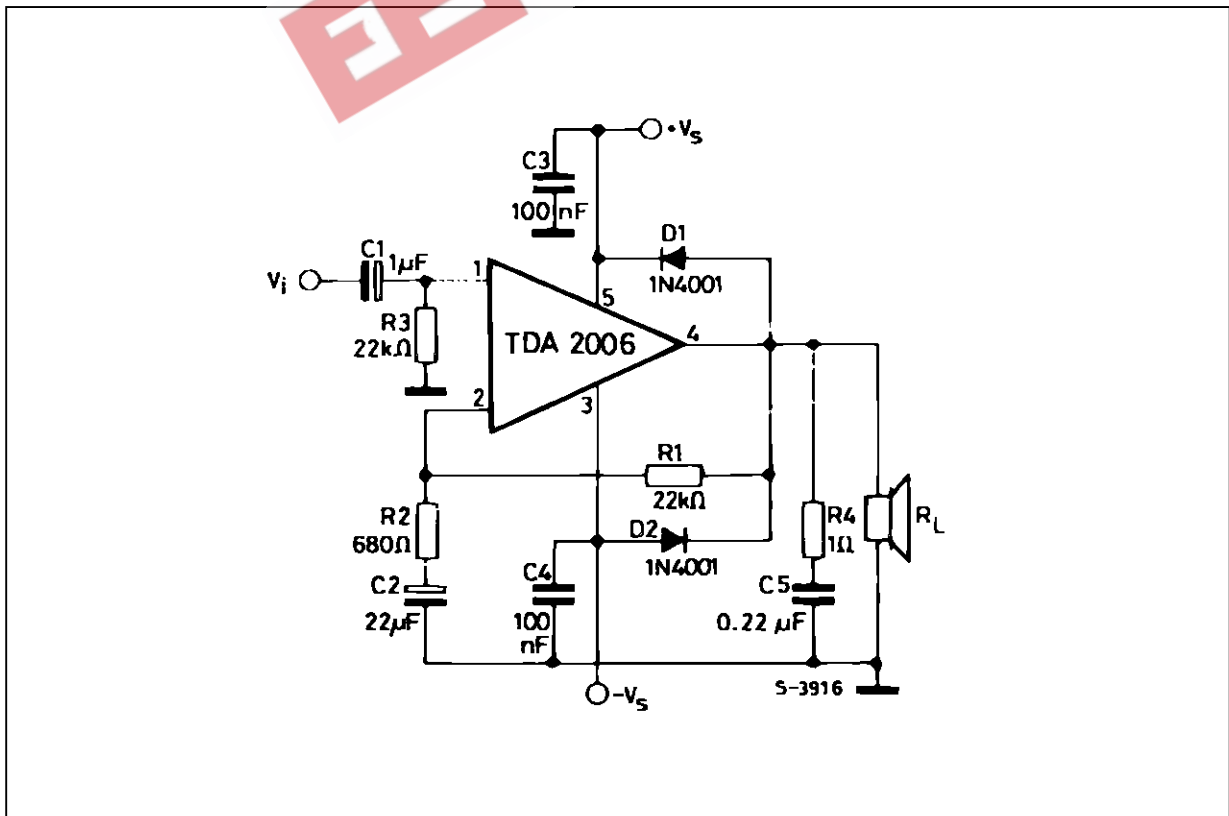

TDA2006

SCHEMATIC DIAGRAM

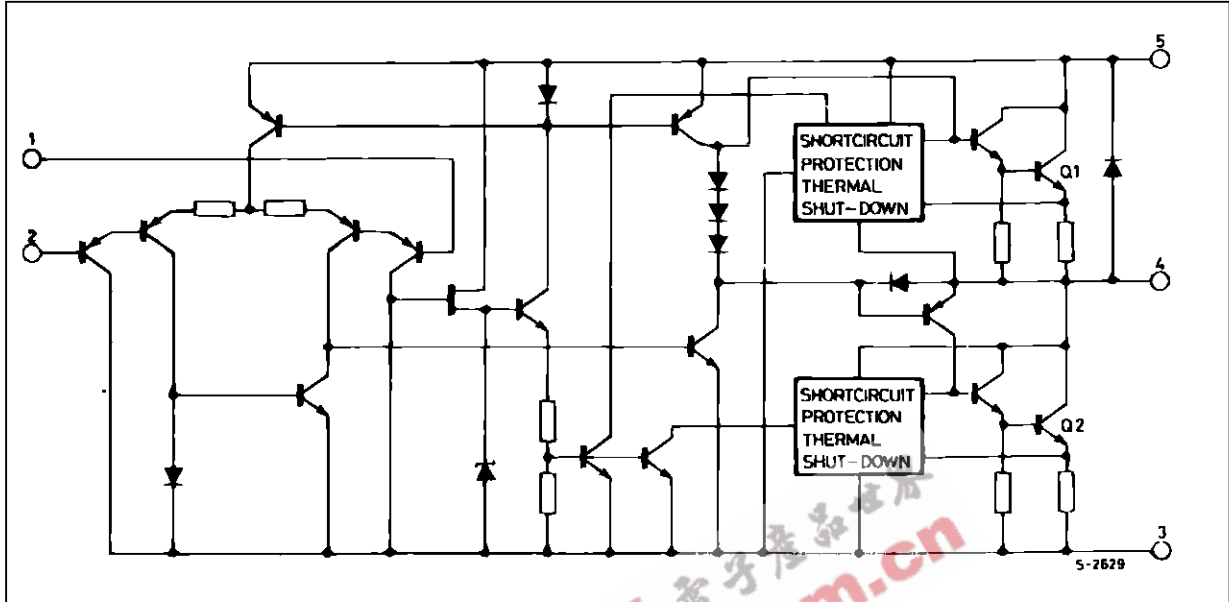

ABSOLUTE MAXIMUM RATINGS

Symbol	Parameter	Value	Unit
V_s	Supply Voltage	± 15	V
V_i	Input Voltage	V_s	
V_i	Differential Input Voltage	± 12	V
I_o	Output Peak Current (internally limited)	3	A
P_{tot}	Power Dissipation at $T_{case} = 90\text{ }^\circ\text{C}$	20	W
T_{stg}, T_j	Storage and Junction Temperature	- 40 to 150	$^\circ\text{C}$

THERMAL DATA

Symbol	Parameter	Value	Unit
$R_{th(j-c)}$	Thermal Resistance Junction-case	Max 3	$^\circ\text{C/W}$

PIN CONNECTION

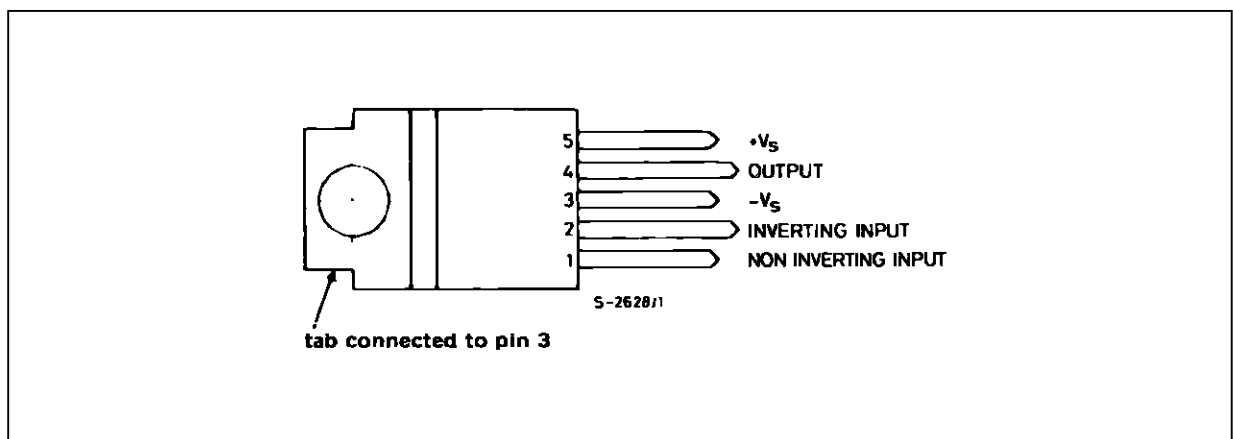

ELECTRICAL CHARACTERISTICS(refer to the test circuit ; $V_S = \pm 12V$, $T_{amb} = 25^\circ C$ unless otherwise specified)

Symbol	Parameter	Test Conditions	Min.	Typ.	Max.	Unit
V_S	Supply Voltage		± 6		± 15	V
I_d	Quiescent Drain Current	$V_S = \pm 15V$		40	80	mA
I_b	Input Bias Current	$V_S = \pm 15V$		0.2	3	μA
V_{OS}	Input Offset Voltage	$V_S = \pm 15V$		± 8		mV
I_{OS}	Input Offset Current	$V_S = \pm 15V$		± 80		nA
V_{OS}	Output Offset Voltage	$V_S = \pm 15V$		± 10	± 100	mV
P_o	Output Power	$d = 10\%$, $f = 1kHz$ $R_L = 4\Omega$ $R_L = 8\Omega$	6	12 8		W
d	Distortion	$P_o = 0.1$ to $8W$, $R_L = 4\Omega$, $f = 1kHz$ $P_o = 0.1$ to $4W$, $R_L = 8\Omega$, $f = 1kHz$		0.2 0.1		% %
V_i	Input Sensitivity	$P_o = 10W$, $R_L = 4\Omega$, $f = 1kHz$ $P_o = 6W$, $R_L = 8\Omega$, $f = 1kHz$		200 220		mV mV
B	Frequency Response ($-3dB$)	$P_o = 8W$, $R_L = 4\Omega$	20Hz to 100kHz			
R_i	Input Resistance (pin 1)	$f = 1kHz$	0.5	5		$M\Omega$
G_v	Voltage Gain (open loop)	$f = 1kHz$		75		dB
G_v	Voltage Gain (closed loop)	$f = 1kHz$	29.5	30	30.5	dB
e_N	Input Noise Voltage	$B (-3dB) = 22Hz$ to $22kHz$, $R_L = 4\Omega$		3	10	μV
i_N	Input Noise Current	$B (-3dB) = 22Hz$ to $22kHz$, $R_L = 4\Omega$		80	200	μA
SVR	Supply Voltage Rejection	$R_L = 4\Omega$, $R_g = 22k\Omega$, $f_{ripple} = 100Hz$ (*)	40	50		dB
I_d	Drain Current	$P_o = 12W$, $R_L = 4\Omega$ $P_o = 8W$, $R_L = 8\Omega$		850 500		mA mA
T_j	Thermal Shutdown Junction Temperature				145	$^\circ C$

(*) Referring to Figure 15, single supply.

Figure 1 : Output Power versus Supply Voltage

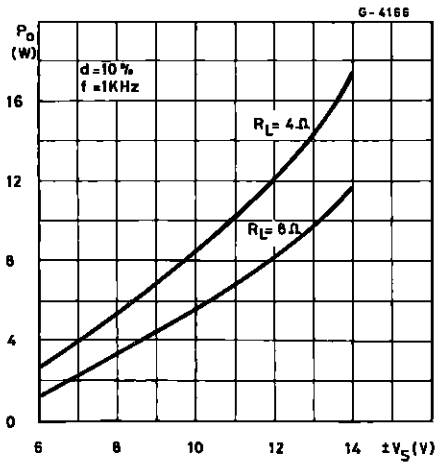

Figure 2 : Distortion versus Output Power

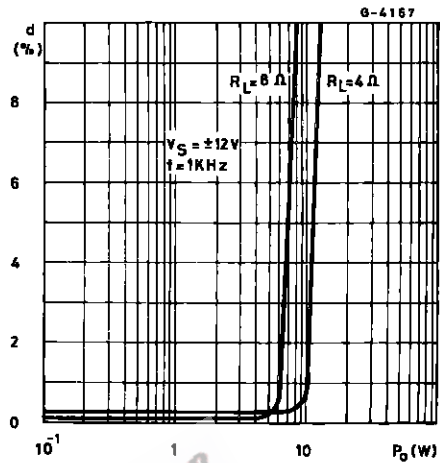

Figure 3 : Distortion versus Frequency

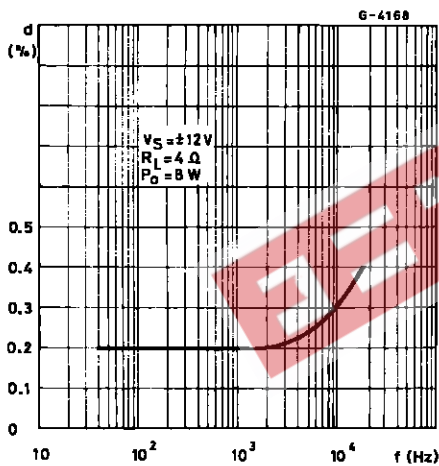

Figure 4 : Distortion versus Frequency

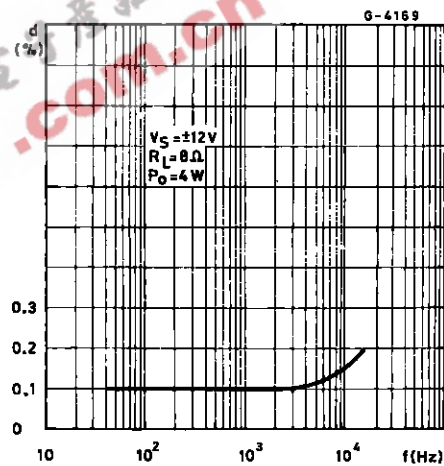

Figure 5 : Sensitivity versus Output Power

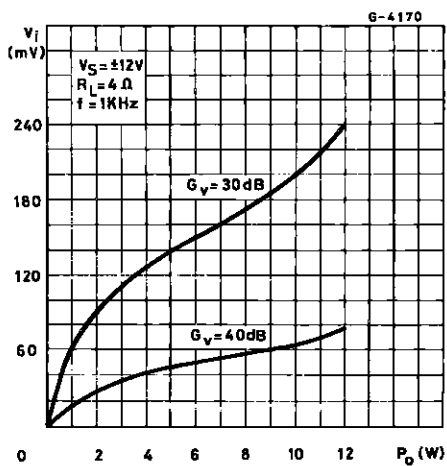

Figure 6 : Sensitivity versus Output Power

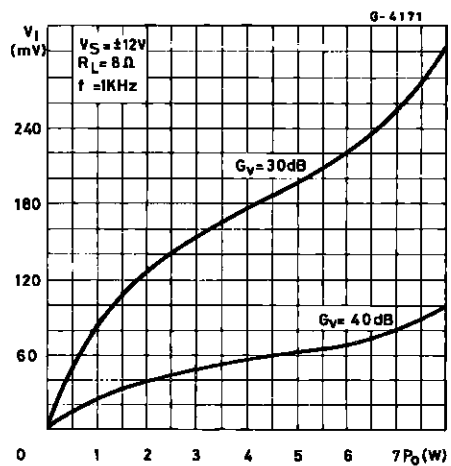

Figure 7 : Frequency Response with different values of the rolloff Capacitor C8 (see Figure 13)

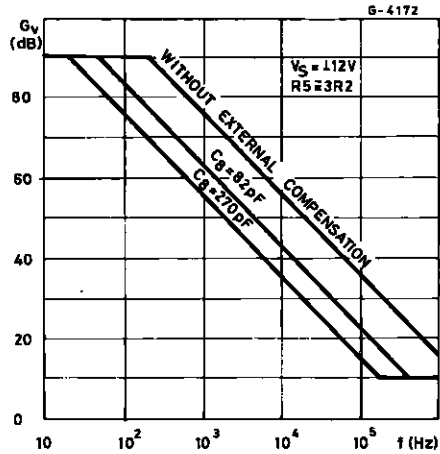

Figure 8 : Value of C8 versus Voltage Gain for different Bandwidths (see Figure 13)

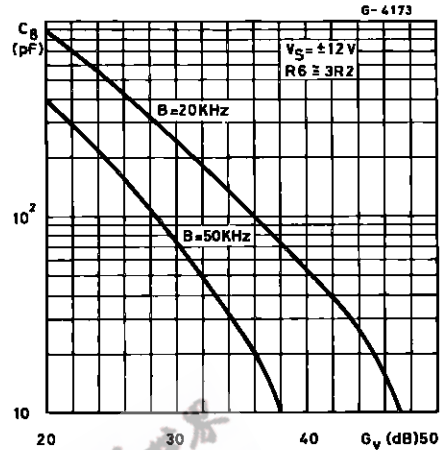

Figure 9 : Quiescent Current versus Supply Voltage

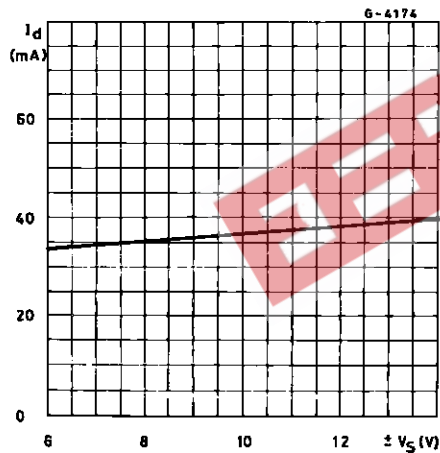

Figure 10 : Supply Voltage Rejection versus Voltage Gain

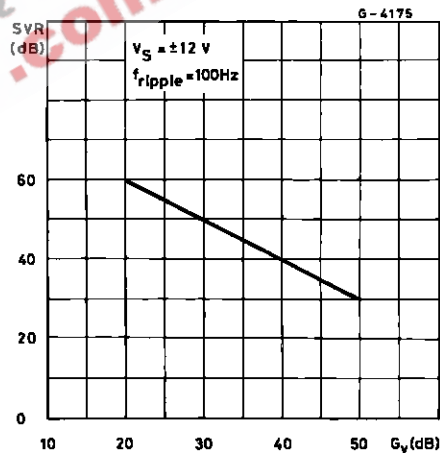

Figure 11 : Power Dissipation and Efficiency versus Output Power

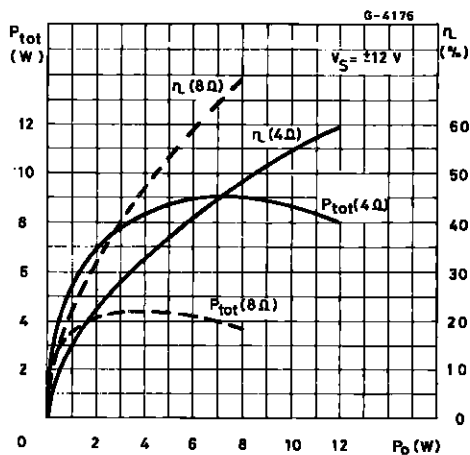
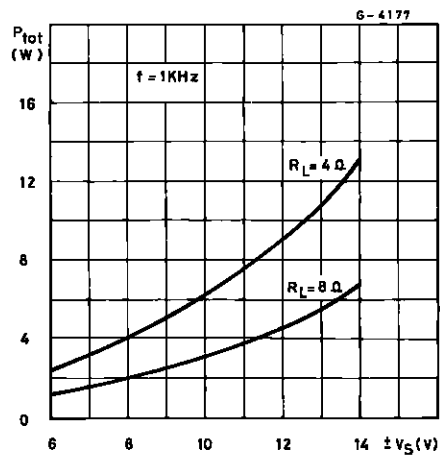

Figure 12 : Maximum Power Dissipation versus Supply Voltage (sine wave operation)



TDA2006

Figure 13 : Application Circuit with Split Power Supply

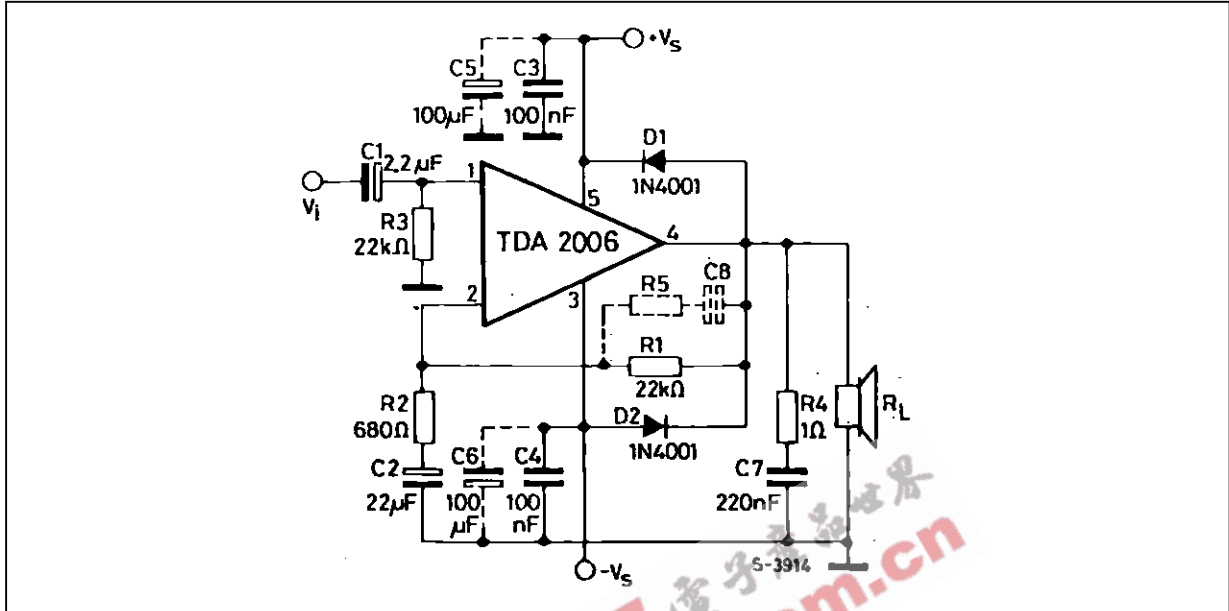

Figure 14 : P.C. Board and Components Layout of the Circuit of Figure 13 (1:1 scale)

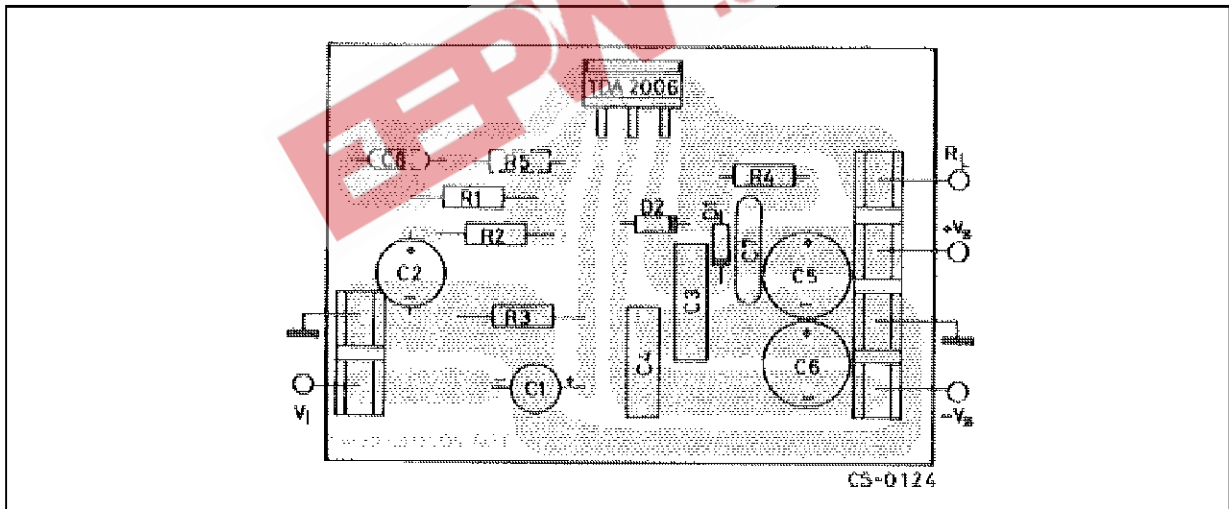

Figure 15 : Application Circuit with Single Power Supply

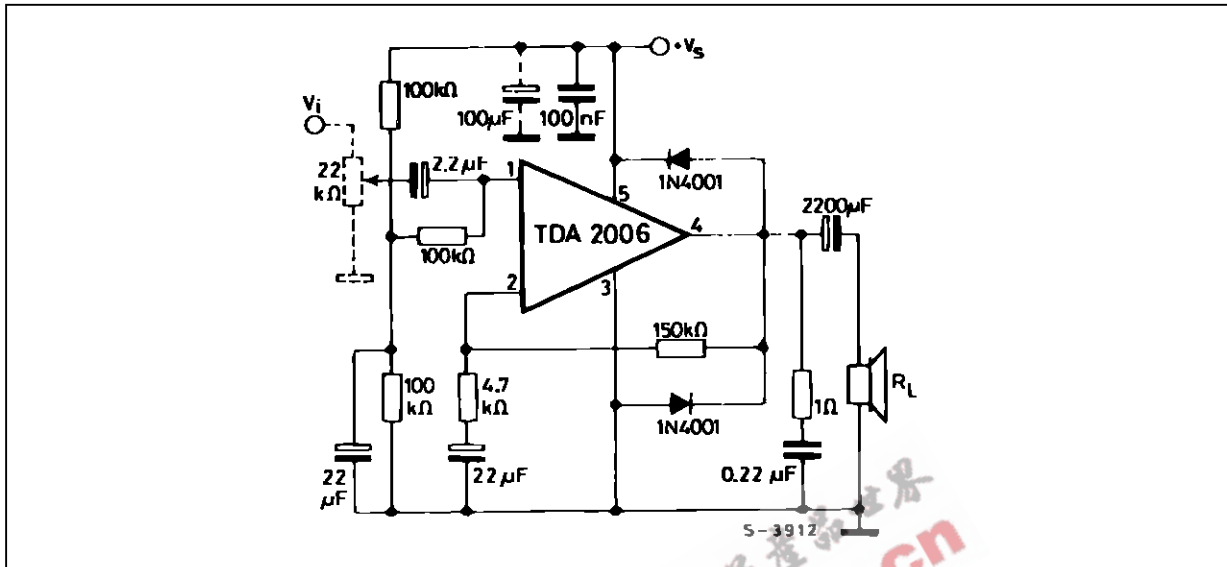
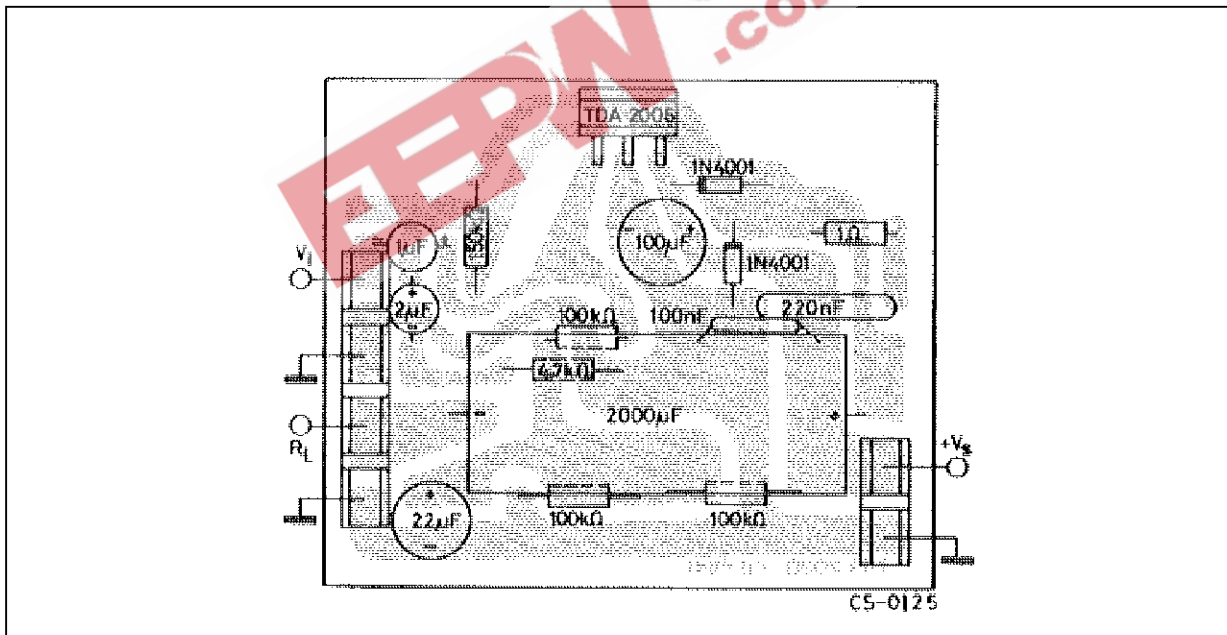
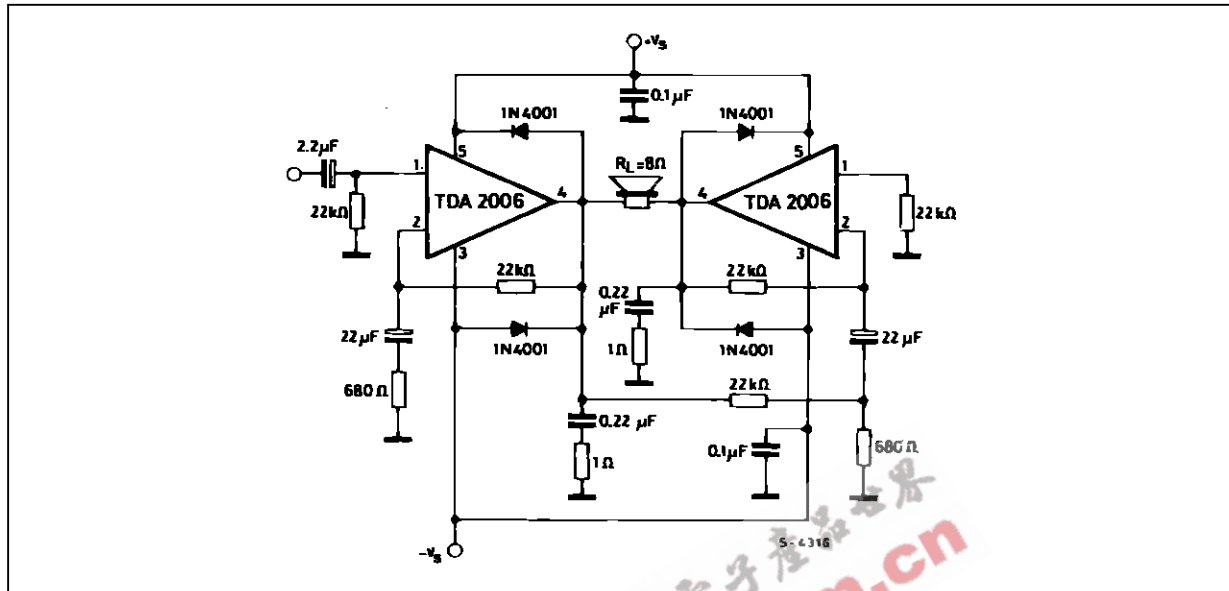

Figure 16 : P.C. Board and Components Layout of the Circuit of Figure 15 (1:1 scale)



TDA2006

Figure 17 : Bridge Amplifier Configuration with Split Power Supply ($P_O = 24W$, $V_S = \pm 12V$)



PRACTICAL CONSIDERATIONS

Printed Circuit Board

The layout shown in Figure 14 should be adopted by the designers. If different layout are used, the ground points of input 1 and input 2 must be well decoupled from ground of the output on which a rather high current flows.

Assembly Suggestion

No electrical isolation is needed between the pack-

age and the heat-sink with single supply voltage configuration.

Application Suggestion

The recommended values of the components are the ones shown on application circuits of Figure 13. Different values can be used. The table 1 can help the designers.

Table 1

Component	Recommended Value	Purpose	Larger Than Recommended Value	Smaller Than Recommended Value
R ₁	22 kΩ	Closed Loop Gain Setting	Increase of Gain	Decrease of Gain (*)
R ₂	680 Ω	Closed Loop Gain Setting	Decrease of Gain (*)	Increase of Gain
R ₃	22 kΩ	Non Inverting Input Biasing	Increase of Input Impedance	Decrease of Input Impedance
R ₄	1 Ω	Frequency Stability	Danger of Oscillation at High Frequencies with Inductive Loads	
R ₅	3 R ₂	Upper Frequency Cut-off	Poor High Frequencies Attenuation	Danger of Oscillation
C ₁	2.2 μF	Input DC Decoupling		Increase of Low Frequencies Cut-off
C ₂	22 μF	Inverting Input DC Decoupling		Increase of Low Frequencies Cut-off
C ₃ C ₄	0.1 μF	Supply Voltage by Pass		Danger of Oscillation
C ₅ C ₆	100 μF	Supply Voltage by Pass		Danger of Oscillation
C ₇	0.22 μF	Frequency Stability		Danger of Oscillation
C ₈	$\frac{1}{2\pi BR_1}$	Upper Frequency Cut-off	Lower Bandwidth	Larger Bandwidth
D ₁ D ₂	1N4001	To Protect the Device Against Output Voltage Spikes.		

(*) Closed loop gain must be higher than 24dB.

SHORT CIRCUIT PROTECTION

The TDA2006 has an original circuit which limits the current of the output transistors. Figure 18 shows that the maximum output current is a function of the collector emitter voltage ; hence the output transistors work within their safe operating area (Figure 19).

This function can therefore be considered as being peak power limiting rather than simple current limiting.

It reduces the possibility that the device gets damaged during an accidental short circuit from AC output to ground.

THERMAL SHUT DOWN

The presence of a thermal limiting circuit offers the following advantages :

- 1) an overload on the output (even if it is permanent), or an above limit ambient temperature can be easily supported since the T_j cannot be higher than 150°C.
- 2) the heatsink can have a smaller factor of safety compared with that of a conventional circuit. There is no possibility of device damage due to high junction temperature.

If for any reason, the junction temperature increases up to 150 °C, the thermal shutdown simply reduces the power dissipation and the current consumption.

The maximum allowable power dissipation depends upon the size of the external heatsink (i.e. its thermal resistance) ; Figure 22 shows the dissippable power as a function of ambient temperature for different thermal resistances.

Figure 18 : Maximum Output Current versus Voltage $V_{CE(sat)}$ across each Output Transistor

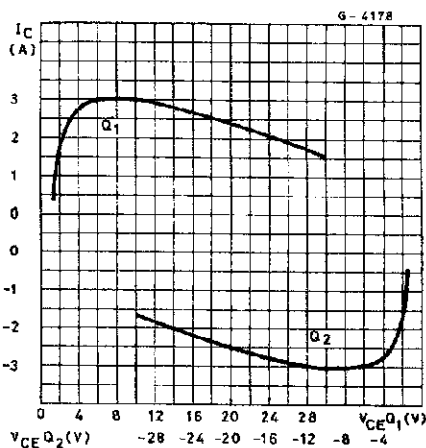

Figure 19 : Safe Operating Area and Collector Characteristics of the Protected Power Transistor

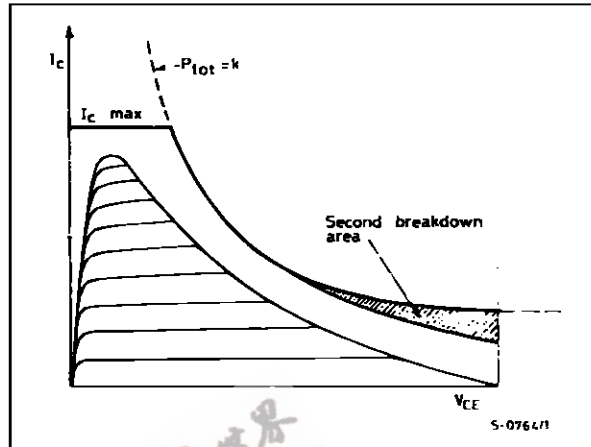

Figure 20 : Output Power and Drain Current versus Case Temperature ($R_L = 4\Omega$)

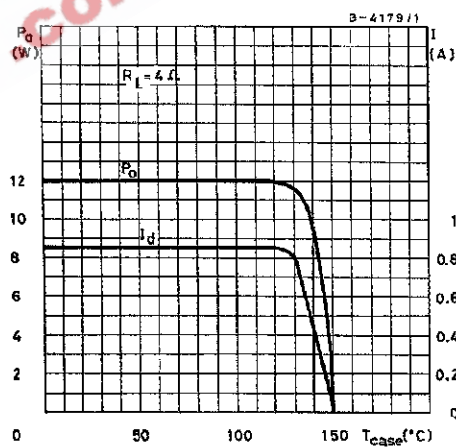

Figure 21 : Output Power and Drain Current versus Case Temperature ($R_L = 8\Omega$)

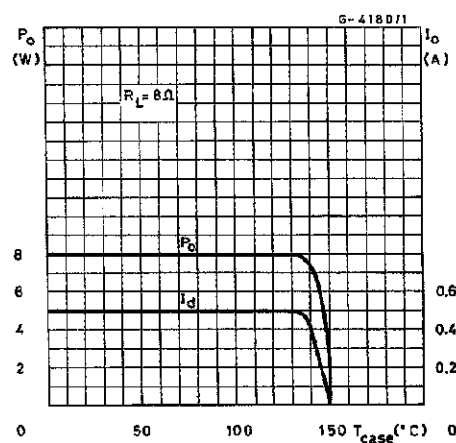
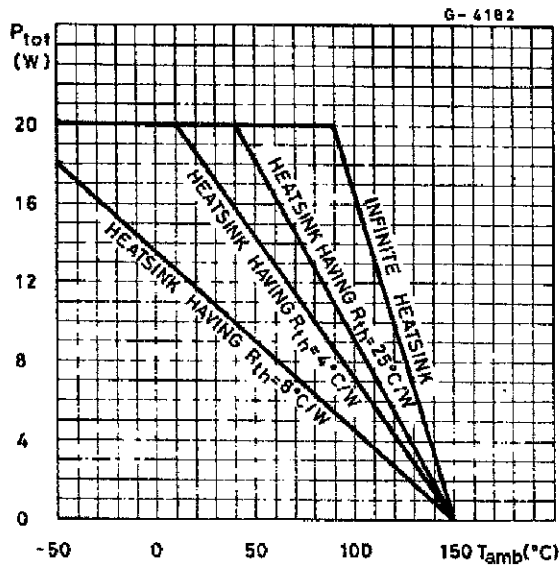

Figure 22 : Maximum Allowable Power Dissipation versus Ambient Temperature



DIMENSION SUGGESTION

The following table shows the length of the heatsink in Figure 23 for several values of P_{tot} and R_{th} .

P_{tot} (W)	12	8	6
Length of Heatsink (mm)	60	40	30
R_{th} of Heatsink ($^{\circ}\text{C}/\text{W}$)	4.2	6.2	8.3

Figure 23 : Example of Heatsink

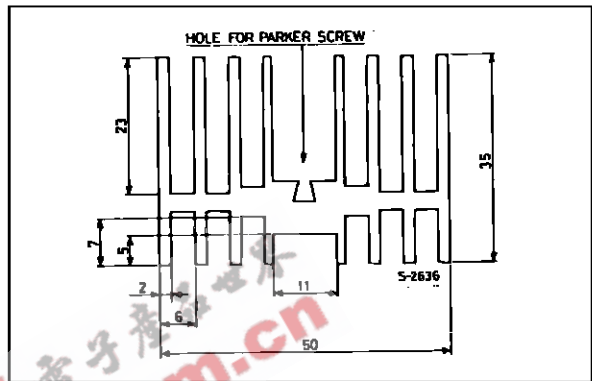

PENTAWATT PACKAGE MECHANICAL DATA

DIM.	mm			inch		
	MIN.	TYP.	MAX.	MIN.	TYP.	MAX.
A			4.8			0.189
C			1.37			0.054
D	2.4		2.8	0.094		0.110
D1	1.2		1.35	0.047		0.053
E	0.35		0.55	0.014		0.022
F	0.8		1.05	0.031		0.041
F1	1		1.4	0.039		0.055
G		3.4		0.126	0.134	0.142
G1		6.8		0.260	0.268	0.276
H2			10.4			0.409
H3	10.05		10.4	0.396		0.409
L		17.85			0.703	
L1		15.75			0.620	
L2		21.4			0.843	
L3		22.5			0.886	
L5	2.6		3	0.102		0.118
L6	15.1		15.8	0.594		0.622
L7	6		6.6	0.236		0.260
M		4.5			0.177	
M1		4			0.157	
Dia	3.65		3.85	0.144		0.152

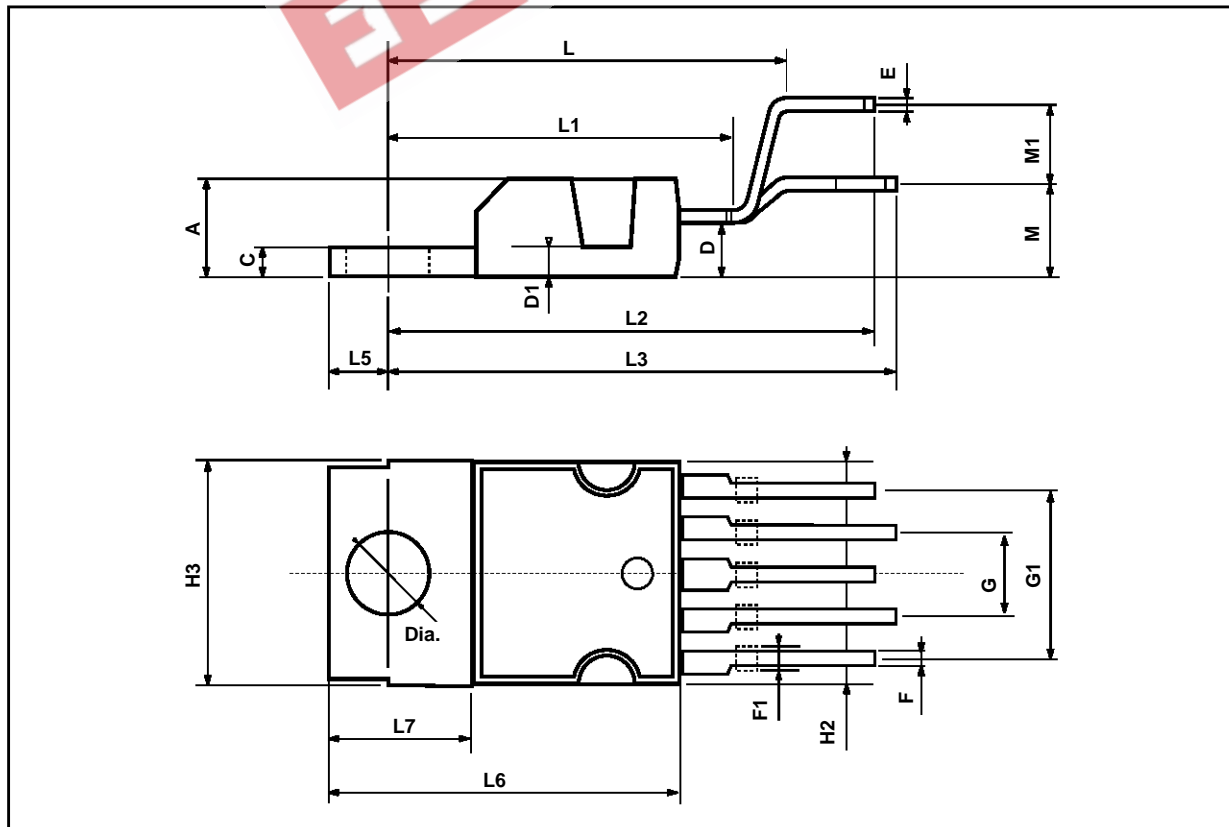

EEPW 电子產品世界
.com.cn

Information furnished is believed to be accurate and reliable. However, SGS-THOMSON Microelectronics assumes no responsibility for the consequences of use of such information nor for any infringement of patents or other rights of third parties which may result from its use. No license is granted by implication or otherwise under any patent or patent rights of SGS-THOMSON Microelectronics. Specifications mentioned in this publication are subject to change without notice. This publication supersedes and replaces all information previously supplied. SGS-THOMSON Microelectronics products are not authorized for use as critical components in life support devices or systems without express written approval of SGS-THOMSON Microelectronics.

© 1995 SGS-THOMSON Microelectronics - All Rights Reserved
PENTAWATT® is Registered Trademark of SGS-THOMSON Microelectronics

SGS-THOMSON Microelectronics GROUP OF COMPANIES
Australia - Brazil - France - Germany - Hong Kong - Italy - Japan - Korea - Malaysia - Malta - Morocco - The Netherlands - Singapore - Spain - Sweden - Switzerland - Taiwan - Thailand - United Kingdom - U.S.A.