

DATA SHEET

EEPW 电子產品世界
.com.cn

TDA1560Q

40 W car radio high power amplifier

Product specification
Supersedes data of 1995 Jul 07
File under Integrated Circuits, IC01

1996 May 14

40 W car radio high power amplifier

TDA1560Q

FEATURES

- Very high output power
- Low power dissipation when used for music signals
- Switches to low output power in the event of excessive heatsink temperatures
- Requires few external components
- Fixed gain
- Low cross-over distortion
- No switch-on/switch-off plops
- Mode select switch
- Low offset voltage at the output
- Load dump protection
- Short-circuit safe to ground, V_P and across load
- Protected against electrostatic discharge
- Thermally protected
- Diagnostic facility
- Flexible leads.

GENERAL DESCRIPTION

The TDA1560Q is an integrated Bridge-Tied Load (BTL) class-H high power amplifier. In a load of 8 Ω , the output power is 40 W typical at a THD of 10%.

The encapsulation is a 17-lead DIL-bent-SIL plastic power package. The device is primarily developed for car radio applications.

QUICK REFERENCE DATA

SYMBOL	PARAMETER	CONDITIONS	MIN.	TYP.	MAX.	UNIT
V_P	supply voltage	operating	8.0	14.4	18	V
		non-operating	–	–	30	V
		load dump protected	–	–	45	V
I_{ORM}	repetitive peak output current		–	–	4	A
$I_{q(tot)}$	total quiescent current		–	100	160	mA
I_{sb}	standby current		–	5	50	μ A
G_v	voltage gain		29	30	31	dB
P_o	output power	$R_L = 8 \Omega$; THD = 10%	–	40	–	W
		$R_L = 8 \Omega$; THD = 0.5%	–	30	–	W
SVRR	supply voltage ripple rejection	$f_i = 100 \text{ Hz to } 10 \text{ kHz}$; $R_S = 0 \Omega$	48	55	–	dB
V_{no}	noise output voltage		–	100	300	μ V
$ Z_i $	input impedance		180	300	–	k Ω
$ \Delta V_O $	DC output offset voltage		–	–	150	mV

ORDERING INFORMATION

TYPE NUMBER	PACKAGE		
	NAME	DESCRIPTION	VERSION
TDA1560Q	DBS17P	plastic DIL-bent-SIL power package; 17 leads (lead length 12 mm)	SOT243-1

40 W car radio high power amplifier

TDA1560Q

BLOCK DIAGRAM

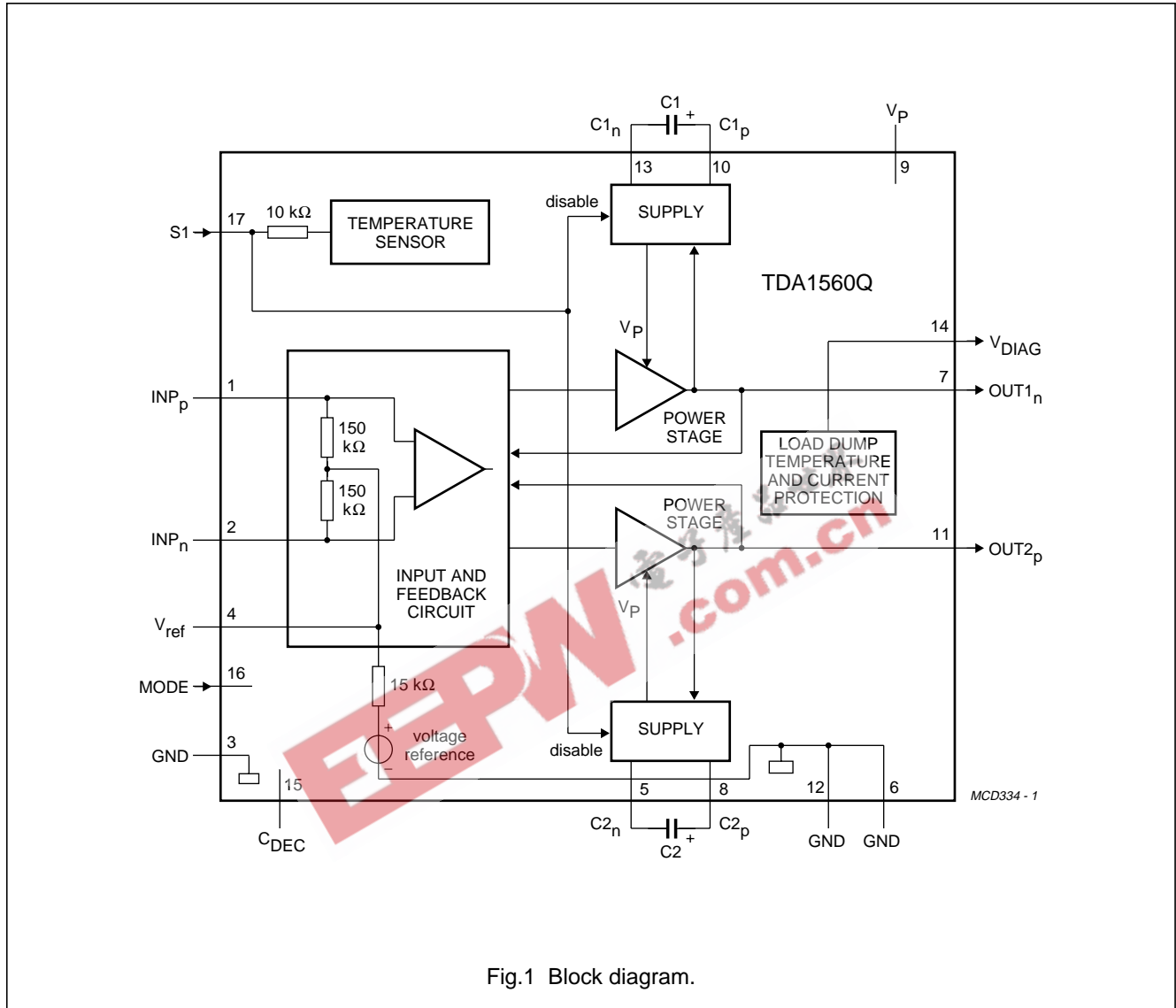

Fig.1 Block diagram.

40 W car radio high power amplifier

TDA1560Q

PINNING

SYMBOL	PIN	DESCRIPTION
INP _p	1	positive input
INP _n	2	negative input
GND	3	ground
V _{ref}	4	reference voltage
C2 _n	5	capacitor C2 negative terminal
GND	6	ground
OUT1 _n	7	output 1 (negative)
C2 _p	8	capacitor C2 positive terminal
V _P	9	supply voltage
C1 _p	10	capacitor C1 positive terminal
OUT2 _p	11	output 2 (positive)
GND	12	ground
C1 _n	13	capacitor C1 negative terminal
V _{DIAG}	14	diagnostic voltage output
C _{DEC}	15	decoupling
MODE	16	mode select switch input
S1	17	class-B/class-H input switch

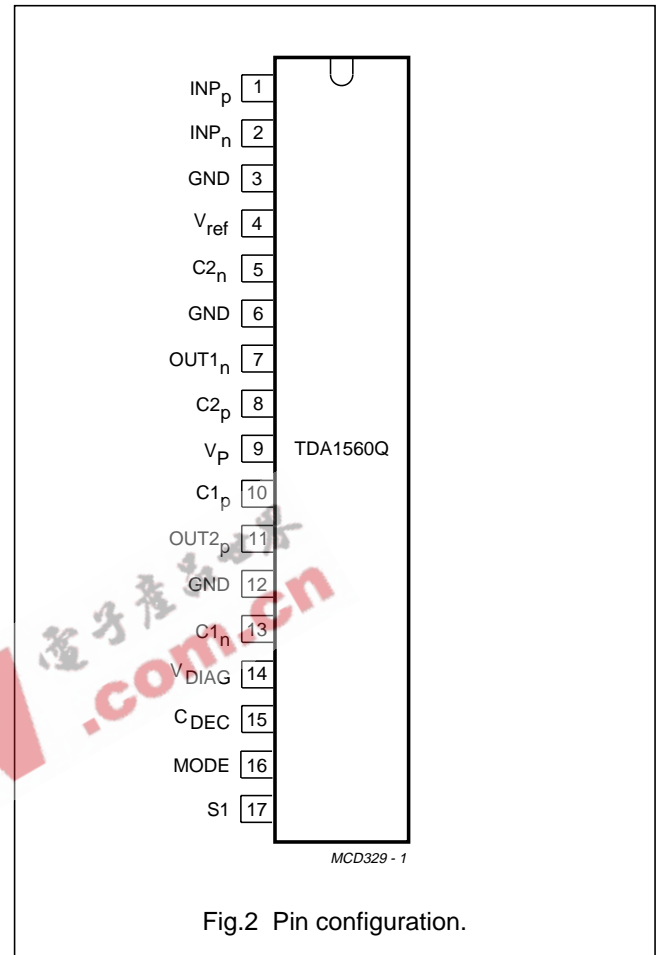

40 W car radio high power amplifier

TDA1560Q

FUNCTIONAL DESCRIPTION

The TDA1560Q contains a mono class-H BTL output power amplifier. At low output power, up to 10 W, the device operates as a normal BTL amplifier. When a larger output voltage swing is required, the internal supply voltage is lifted to approximately twice the external supply voltage. This extra supply voltage is obtained from the charge in the external electrolytic capacitors. Due to this momentarily higher supply voltage, the maximum output power is 40 W typical at a THD of 10%.

In normal use, when the output is driven with music-type signals, the high output power is only required for a small percentage of the time. Assuming a music signal has a normal (Gaussian) amplitude distribution, the reduction in dissipation is approximately 50% when compared to a class-B output amplifier with the same output power. The heatsink should be designed for use with music signals.

If the device is **continuous sine wave** driven, instead of driven with music signals and at a high output power (class-H operation), the case temperature can rise above 120 °C with such a practical heatsink. In this event, the thermal protection disables the high power supply voltage and limits the output power to 10 W and the maximum dissipation to 5 W.

The gain of each amplifier is internally fixed at 30 dB. With the mode select input the device can be switched to the following modes:

- Low standby current (<50 μ A)
- Mute condition, DC adjusted
- On, operation in class-B, limited output power
- On, operation in class-H, high output power.

The device can be used as a normal BTL class-AB amplifier if the electrolytic capacitors C1 and C2 are omitted; see Fig.6. If the case temperature exceeds 120 °C, the device will switch back from class-H to class-B operation. The high power supply voltage is then disabled and the output power is limited to 10 W. By measuring the voltage on the class-B/class-H pin, the actual crystal temperature can be detected.

The open voltage on the class-B/class-H pin is related to the global temperature of the crystal. By measuring this voltage, external actions can be taken to reduce an excessive temperature (e.g. by cutting off low frequencies or externally switching to class-B). For the relationship between the crystal temperature and the voltage on this pin, see Fig.3.

By forcing a high voltage level on the class-B/class-H pin, thereby simulating a high temperature, the device can be externally switched to class-B operation. Similarly, by forcing a low voltage level on the class-B/class-H pin, thereby simulating a low temperature, the device can be forced into class-H operation, even if the case temperature exceeds 120 °C.

The device is fully protected against short-circuiting of the outputs to ground or V_P and across the load, high crystal temperature and electrostatic discharge at all input and output pins. In the event of a continuing short-circuit to ground or V_P , excessive dissipation is prevented because the output stages will be switched off. The output stages will be switched on again within 20 ms after the short-circuit has been removed.

A diagnostic facility is available at pin 14. In normal conditions the voltage at this pin will be the supply voltage (V_P). In the event of the following conditions:

- Junction temperature exceeds 150 °C
- Short-circuit of one of the outputs to ground or to V_P
- Load dump; $V_P > 20$ V.

The voltage level at pin 14 will be at a constant level of approximately $\frac{1}{2}V_P$ during fault condition. At a short-circuit over the load, pin 14 will be at $\frac{1}{2}V_P$ for approximately 20 ms and V_P for approximately 50 μ s.

40 W car radio high power amplifier

TDA1560Q

LIMITING VALUES

In accordance with the Absolute Maximum Rating System (IEC 134).

SYMBOL	PARAMETER	CONDITIONS	MIN.	MAX.	UNIT
V _P	supply voltage	operating	–	18	V
		non-operating	–	30	V
		load dump protection; t _r ≥ 2.5 ms	–	45	V
I _{OSM}	non-repetitive peak output current		–	6	A
I _{ORM}	repetitive peak output current		–	4	A
V _{P(sc)}	AC and DC short-circuit safe voltage		–	18	V
E _{cap}	energy handling capability at outputs	V _P = 0	–	200	mJ
I _{I7}	current at pin 17	V _{I7} < V _P – 1	–	5	mA
P _{tot}	total power dissipation		–	60	W
T _{stg}	storage temperature		–55	+150	°C
T _{amb}	operating ambient temperature		–40	–	°C

THERMAL CHARACTERISTICS

SYMBOL	PARAMETER	VALUE	UNIT
R _{th j-a}	thermal resistance from junction to ambient in free air	40	K/W
R _{th j-case}	thermal resistance from junction to case (measured in Fig.6)	3	K/W

Heatsink design

There are two parameters that determine the size of the heatsink. The first is the rating for the case temperature and the second is the ambient temperature at which the amplifier must still deliver its full power in the class-H mode.

EXAMPLE 1

With an 8 Ω load and driven with a **music signal**, the maximum power dissipation is approximately 6.5 W. If the amplifier is to deliver its full power at ambient temperatures up to 50 °C the case temperature should not be higher than 120 °C for class-H operation.

R_{th case-h} = 1 K/W, thus the external heatsink should be:

$$\frac{120 - 50}{6.5} - 1.0 = 10 \text{ K/W}$$

In this example and with an 8 Ω load, the size of the heatsink is determined by the rating for the maximum full power ambient temperature. If the case temperature of the device exceeds 120 °C then the device switches back to class-B, see “Example 2”.

EXAMPLE 2

With disabled class-H mode, an 8 Ω load and driven with a **sine wave signal** the maximum power dissipation is approximately 5 W. At a virtual junction temperature of 150 °C and T_{amb(max)} at 60 °C, R_{th vj-case} = 3 K/W and R_{th case-h} = 1 K/W the thermal resistance of the heatsink should be:

$$\frac{150 - 60}{5} - 3 - 1 = 14 \text{ K/W}$$

In this example the size of the heatsink is determined by the virtual junction temperature.

40 W car radio high power amplifier

TDA1560Q

DC CHARACTERISTICS

$V_P = 14.4$ V; $R_L = 8$ Ω ; $T_{amb} = 25$ °C and using 4 K/W heatsink; measured in Fig.6; unless otherwise specified.

SYMBOL	PARAMETER	CONDITIONS	MIN.	TYP.	MAX.	UNIT
Supply						
V_P	supply voltage	note 1	8.0	14.4	18.0	V
$I_{q(tot)}$	total quiescent current		–	100	160	mA
V_O	DC output voltage	note 2	–	6.5	–	V
$ \Delta V_O $	DC output offset voltage		–	–	150	mV
V_{14}	diagnostic output voltage	note 3	6	–	8	V
Mode select switch (see Fig.4)						
V_{16}	switch input voltage level	standby condition	0	–	1.2	V
		mute condition	2.6	–	3.5	V
		class-B operation	4.5	–	7.0	V
		class-H operation	8.5	–	V_P	V
$I_{SW\ max}$	maximum switch current		–	–	20	μ A
I_{sb}	DC supply current	standby condition	–	5	50	μ A
$ \Delta V_O $	DC output offset voltage	mute condition	–	–	150	mV
		mute-on step; note 4	–	–	150	mV
V_O	output signal voltage in mute condition	$V_{i(max)} = 1$ V; $f_i = 20$ Hz to 15 kHz	–	–	2	mV
Class-B/class-H operation (see Fig.3 and note 5)						
V_{17}	switch input voltage level	class-B operation	2.5	–	$V_P - 1$	V
		class-H operation	0	–	1.0	V
I_{SW}	switch current	note 6	–	–	2	mA
T_{case}	case temperature for switching to class-B		–	120	–	°C

Notes

1. The circuit is DC adjusted at $V_P = 8$ to 18 V and AC operating at $V_P = 8.5$ to 18 V.
2. The DC output voltage, or the common mode voltage on the loudspeaker terminals with respect to ground, is 6.3 V at output power up to 8.5 W. At higher output power, the common mode voltage will be higher.
3. The voltage at pin 14 is approximately $\frac{1}{2}V_P$ in the event of a short-circuit, load dump or temperature protection. Any circuit connected to pin 14 should have an input resistance of >2 M Ω and an input capacitance of <5 nF.
4. The DC output offset voltage step is the difference in output offset voltage in the mute condition and the on condition. The absolute value of this voltage step is given as $|\Delta V_{O\ mute} - \Delta V_{O\ on}| < 150$ mV.
5. Figure 3 shows the relationship between the global crystal temperature and the open voltage at the class-B/class-H pin.
6. The maximum voltage on pin 17 is $V_P - 1$ ($V_P \leq 18$ V).

40 W car radio high power amplifier

TDA1560Q

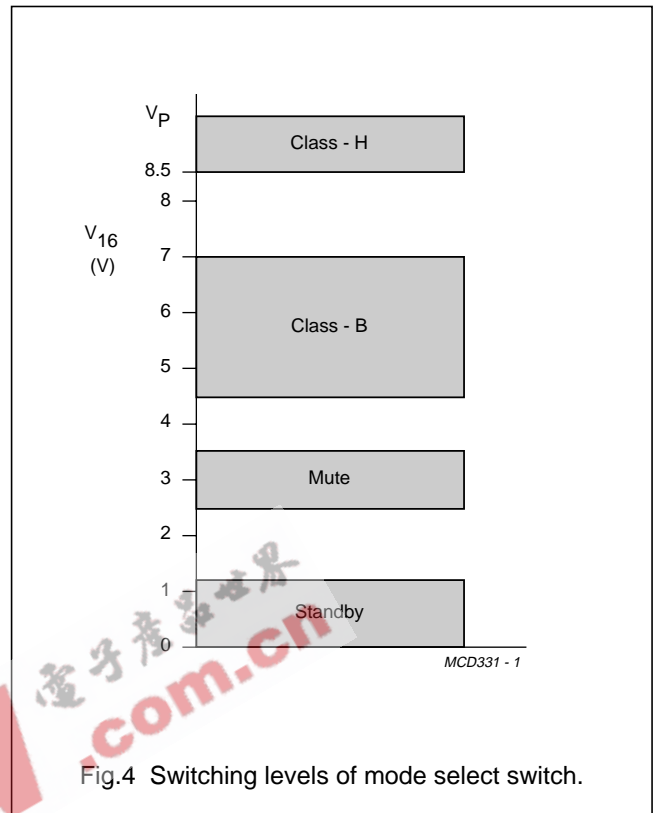
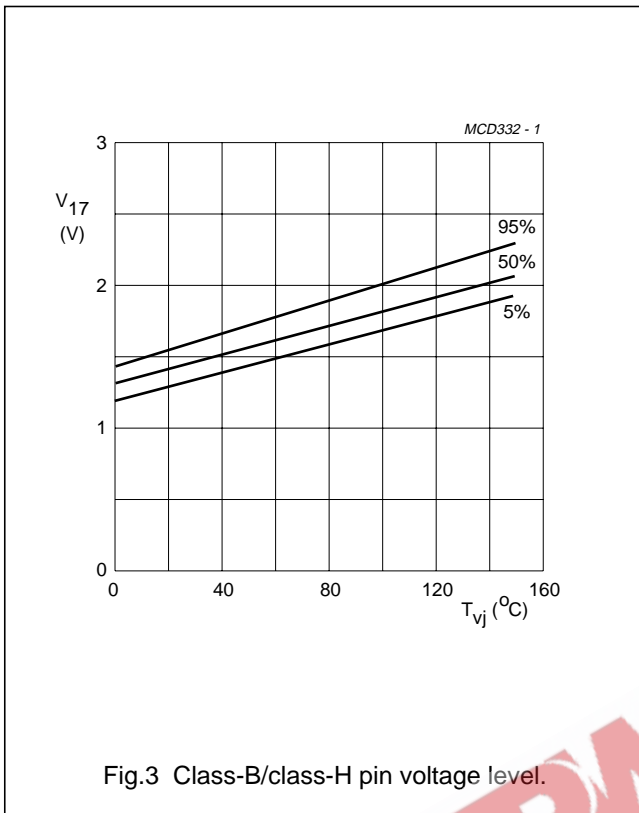

40 W car radio high power amplifier

TDA1560Q

AC CHARACTERISTICS

$V_P = 14.4$ V; $R_L = 8$ Ω ; $f_i = 1$ kHz; $T_{amb} = 25$ °C and using 4 K/W heatsink; measured in Fig.6; unless otherwise specified.

SYMBOL	PARAMETER	CONDITIONS	MIN.	TYP.	MAX.	UNIT
P_o	output power	class-H operation				
		THD = 0.5%	27	30	–	W
		THD = 10%; continuously driven	36	39	–	W
		THD = 10%; with burst signals; note 1	–	40	–	W
		class-B operation				
		THD = 10%	7	10	–	W
THD	total harmonic distortion	$P_o = 1$ W	–	0.05	–	%
		$P_o = 10$ W	–	0.1	–	%
B	power bandwidth	THD = 0.5%; $P_o = -1$ dB with respect to 30 W; note 2	–	40 to 15000	–	Hz
f_{lr}	low frequency roll-off	-3 dB; note 3	–	40	–	Hz
f_{hr}	high frequency roll-off	-1 dB	20	–	–	kHz
G_v	voltage gain		29	30	31	dB
SVRR	supply voltage ripple rejection	note 4				
		on	48	55	–	dB
		mute	48	65	–	dB
		standby	80	–	–	dB
CMRR	common mode rejection ratio	note 5	64	–	–	dB
$V_{i(max)}$	maximum input voltage		–	1.2	–	V
V_{no}	noise output voltage	on; $R_S = 0$ Ω ; note 6	–	100	300	μ V
		on; $R_S = 10$ k Ω ; note 6	–	150	–	μ V
		mute; notes 6 and 7	–	100	–	μ V
$ Z_i $	input impedance	note 8	180	300	–	k Ω

Notes

1. With a continuous sine wave input signal the output power is approximately 1 W less than driven with a bursted signal; also depending on the equivalent series resistance of the electrolytic capacitors C1 and C2 (see Fig.6) and the resistance of the connections between pins 5, 8, 10 and 13 and C1, C2.
2. The power bandwidth is limited by the value of the electrolytic capacitors C1 and C2.
3. Frequency response is externally fixed by the input coupling capacitor.
4. Ripple rejection measured at the output, across R_L , with a source impedance of 0 Ω and a frequency between 100 Hz and 10 kHz, and an amplitude of 2 V (p-p). The maximum supply voltage ripple is 2.5 V RMS.
5. The common mode rejection ratio is measured at the output, across R_L , with a voltage source (500 mV RMS) between both short-circuited inputs and signal ground (see Fig.5). Frequencies are between 100 Hz and 10 kHz.
6. Noise output voltage measured in a bandwidth of 20 Hz to 20 kHz.
7. Noise output voltage independent of source impedance.
8. Input impedance without external resistor (R_{ex}).

40 W car radio high power amplifier

TDA1560Q

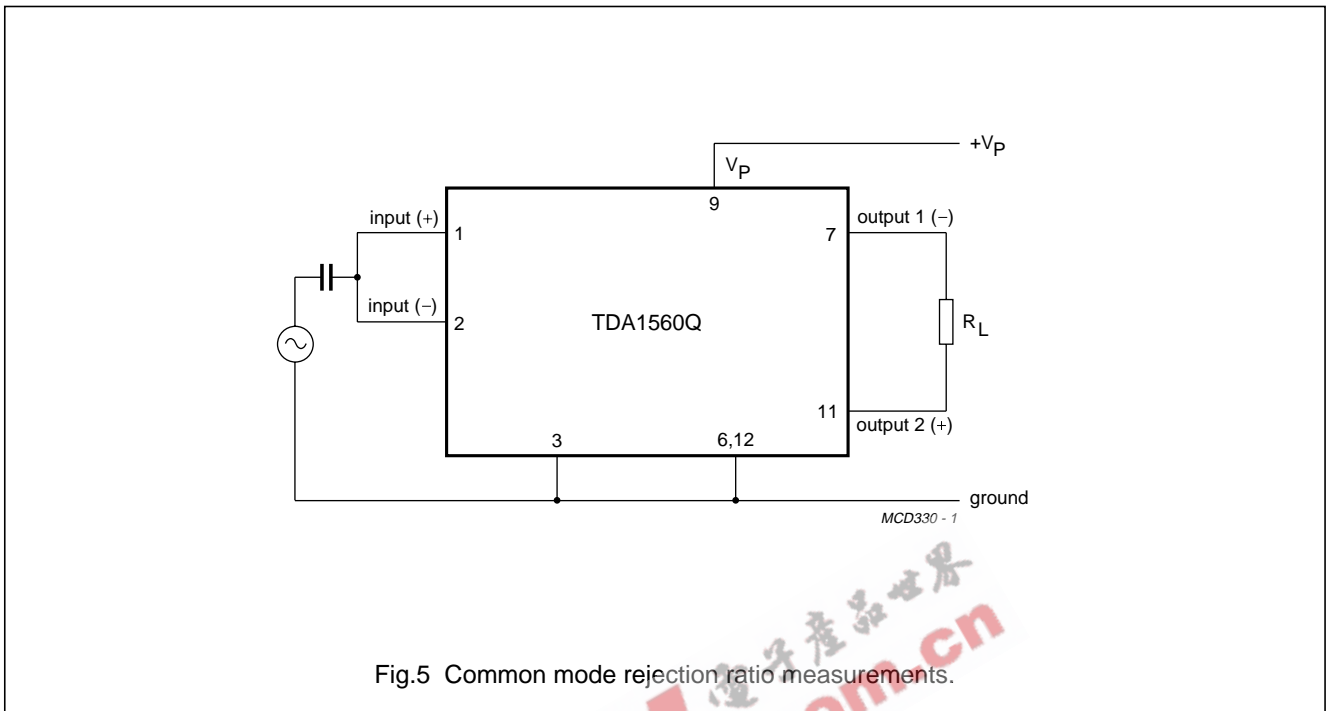

Table 1 Values of capacitors C1, C2 and C_k and frequency roll off

f at -3 dB (Hz)	C1, C2 (μF)	C _k (nF)
10	4700	560
20	3300	270
30	2200	180
40	2200	150
50	1500	100
60	1500	82
70	1000	68

40 W car radio high power amplifier

TDA1560Q

APPLICATION INFORMATION

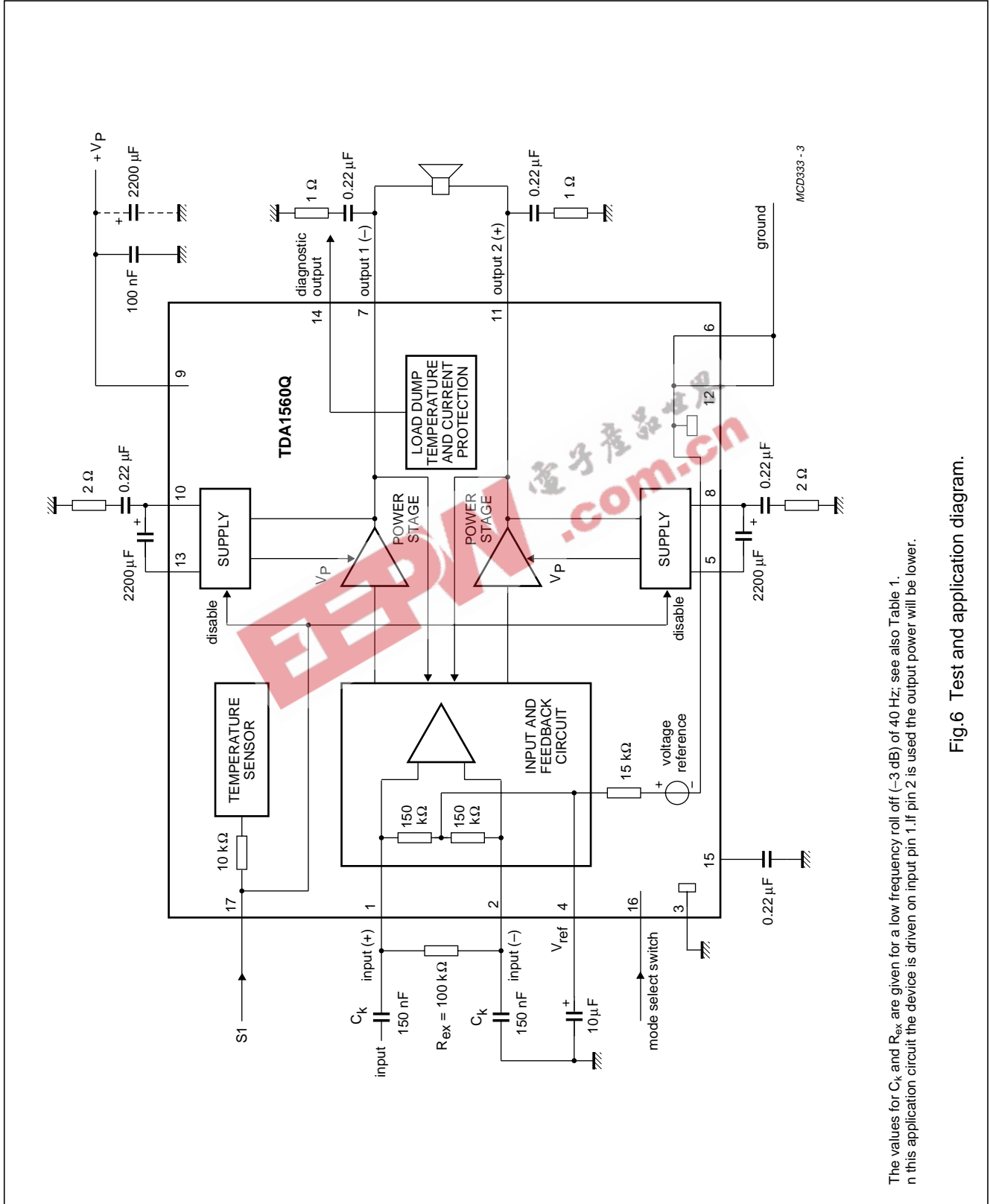

The values for C_k and R_{ex} are given for a low frequency roll off (-3 dB) of 40 Hz; see also Table 1. In this application circuit the device is driven on input pin 1. If pin 2 is used the output power will be lower.

Fig.6 Test and application diagram.

40 W car radio high power amplifier

TDA1560Q

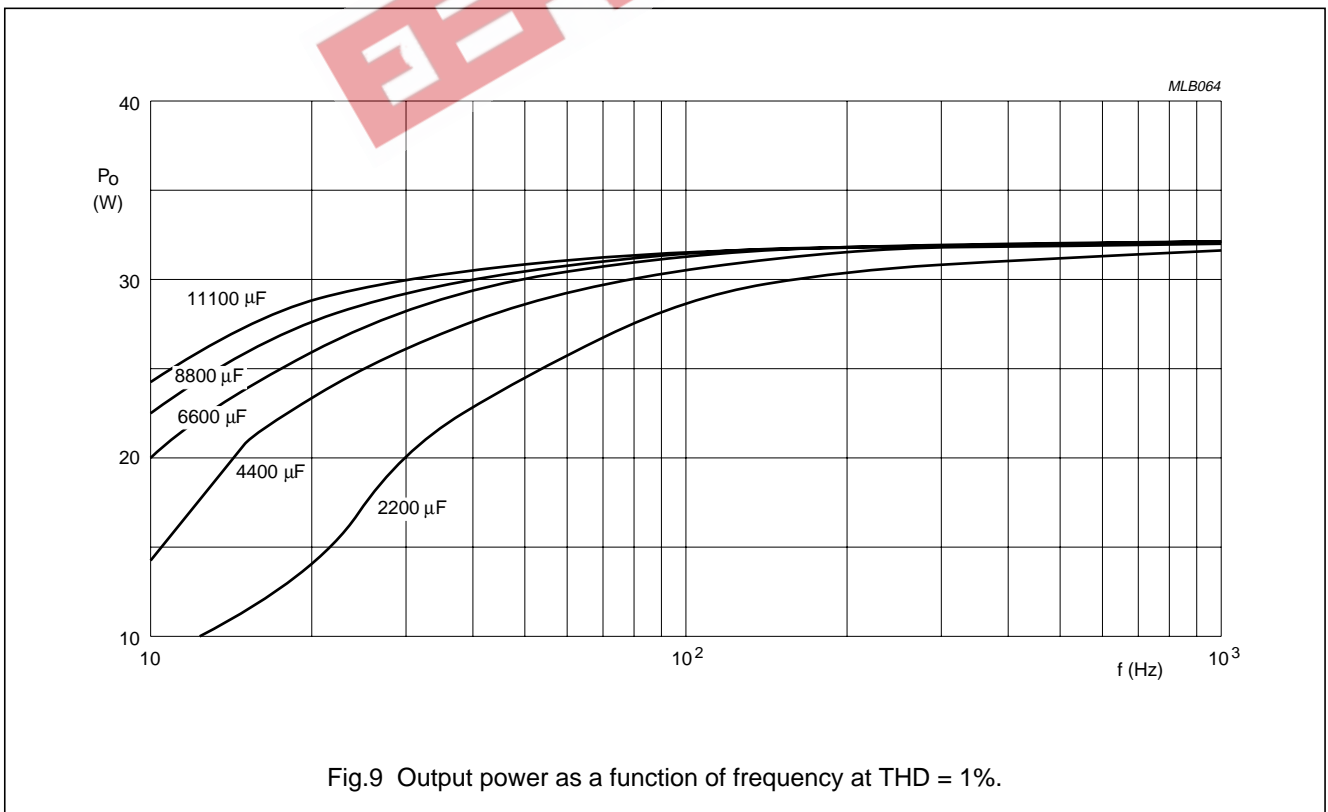
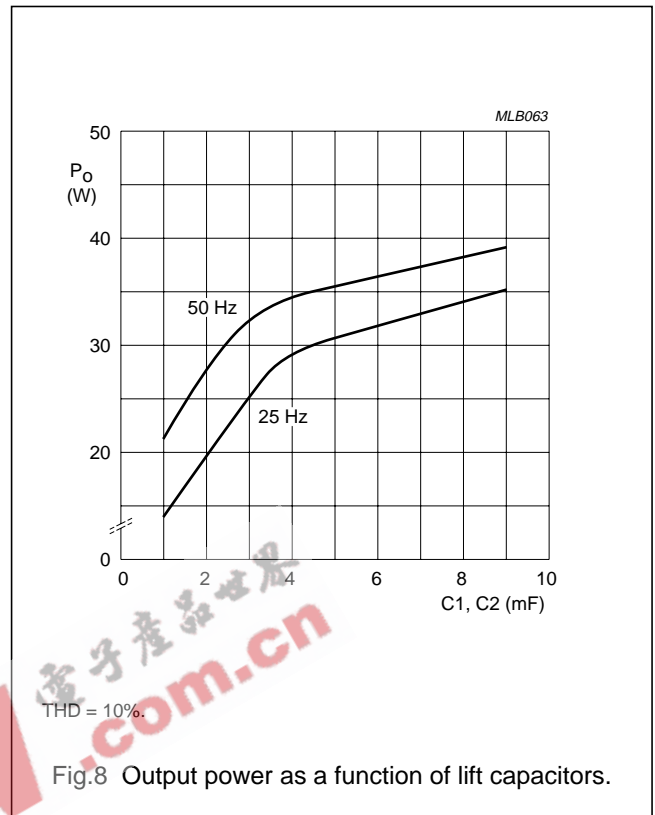
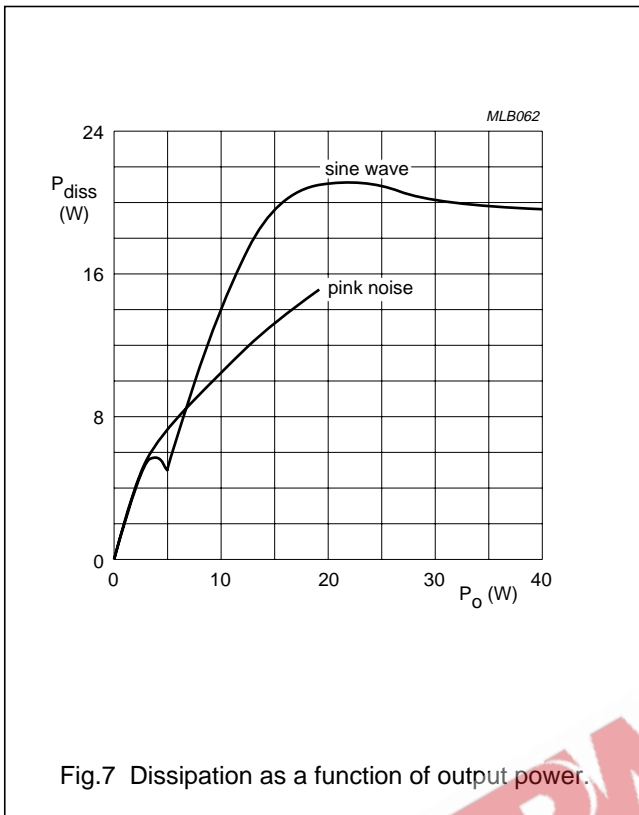

40 W car radio high power amplifier

TDA1560Q

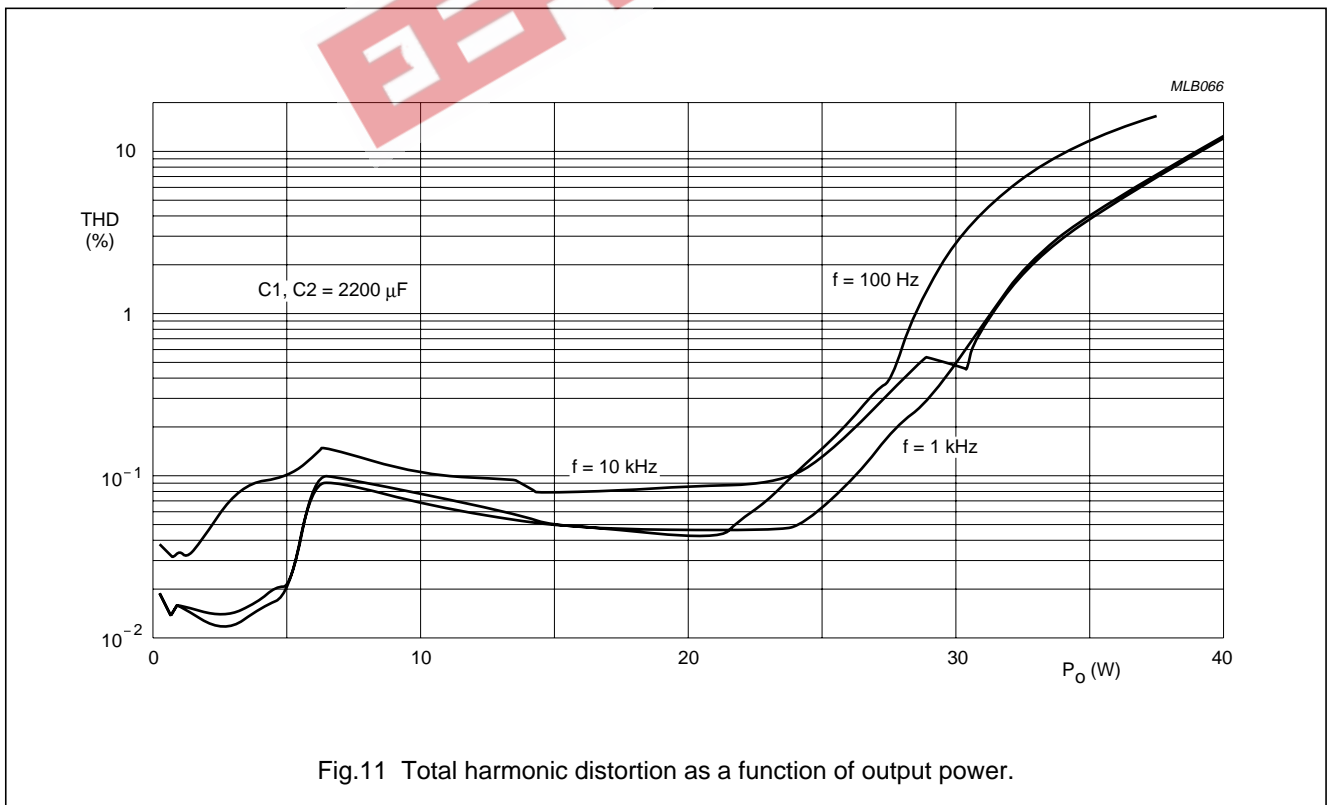
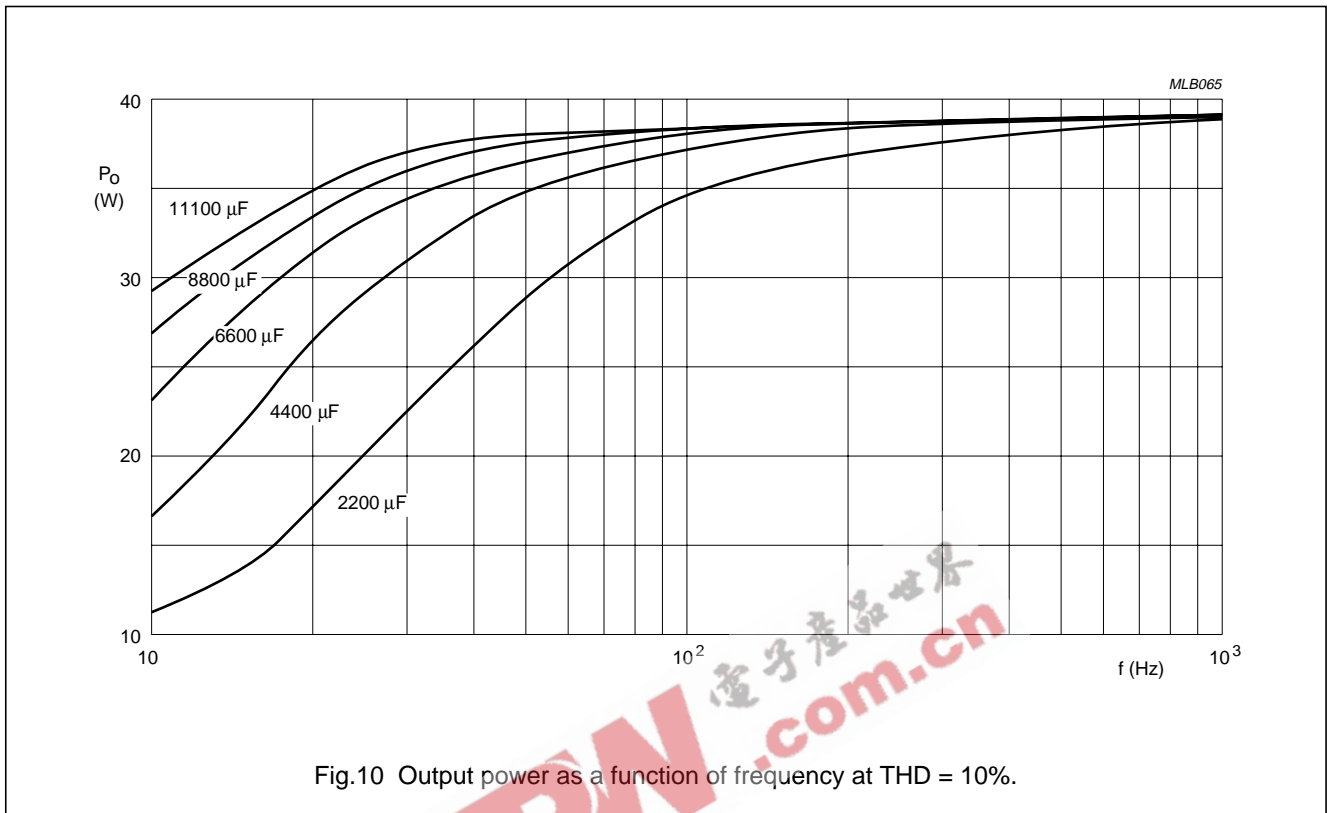

40 W car radio high power amplifier

TDA1560Q

PACKAGE OUTLINE

DBS17P: plastic DIL-bent-SIL power package; 17 leads (lead length 12 mm)

SOT243-1

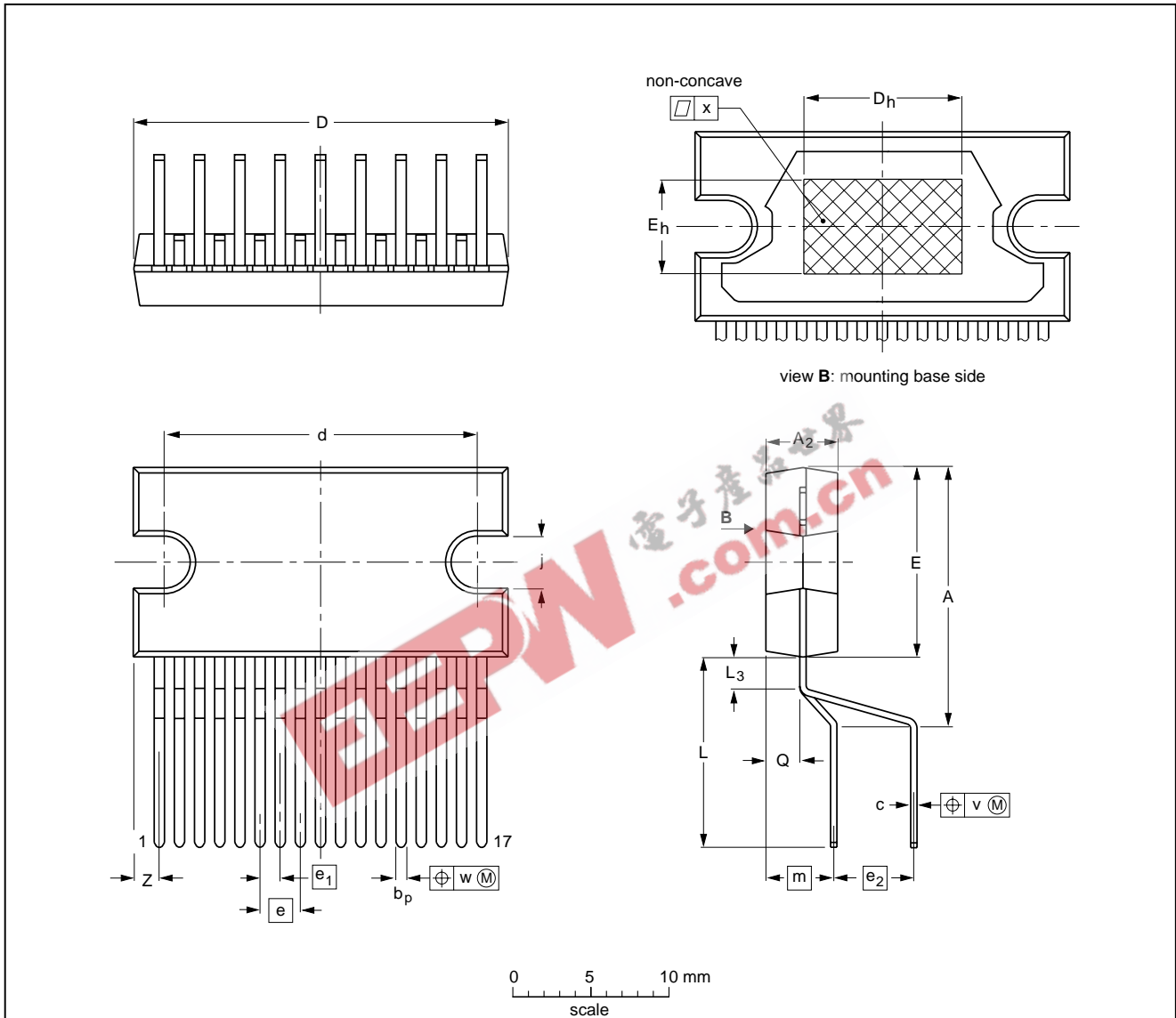

DIMENSIONS (mm are the original dimensions)

UNIT	A	A ₂	b _p	c	D ⁽¹⁾	d	D _h	E ⁽¹⁾	e	e ₁	e ₂	E _h	j	L	L ₃	m	Q	v	w	x	Z ⁽¹⁾
mm	17.0 15.5	4.6 4.2	0.75 0.60	0.48 0.38	24.0 23.6	20.0 19.6	10	12.2 11.8	2.54	1.27	5.08	6	3.4 3.1	12.4 11.0	2.4 1.6	4.3	2.1 1.8	0.8	0.4	0.03	2.00 1.45

Note

1. Plastic or metal protrusions of 0.25 mm maximum per side are not included.

OUTLINE VERSION	REFERENCES				EUROPEAN PROJECTION	ISSUE DATE
	IEC	JEDEC	EIAJ			
SOT243-1						95-03-11 97-12-16

40 W car radio high power amplifier

TDA1560Q

SOLDERING**Introduction**

There is no soldering method that is ideal for all IC packages. Wave soldering is often preferred when through-hole and surface mounted components are mixed on one printed-circuit board. However, wave soldering is not always suitable for surface mounted ICs, or for printed-circuits with high population densities. In these situations reflow soldering is often used.

This text gives a very brief insight to a complex technology. A more in-depth account of soldering ICs can be found in our "IC Package Databook" (order code 9398 652 90011).

Soldering by dipping or by wave

The maximum permissible temperature of the solder is 260 °C; solder at this temperature must not be in contact with the joint for more than 5 seconds. The total contact time of successive solder waves must not exceed 5 seconds.

The device may be mounted up to the seating plane, but the temperature of the plastic body must not exceed the specified maximum storage temperature ($T_{stg\ max}$). If the printed-circuit board has been pre-heated, forced cooling may be necessary immediately after soldering to keep the temperature within the permissible limit.

Repairing soldered joints

Apply a low voltage soldering iron (less than 24 V) to the lead(s) of the package, below the seating plane or not more than 2 mm above it. If the temperature of the soldering iron bit is less than 300 °C it may remain in contact for up to 10 seconds. If the bit temperature is between 300 and 400 °C, contact may be up to 5 seconds.

DEFINITIONS

Data sheet status	
Objective specification	This data sheet contains target or goal specifications for product development.
Preliminary specification	This data sheet contains preliminary data; supplementary data may be published later.
Product specification	This data sheet contains final product specifications.
Limiting values	
Limiting values given are in accordance with the Absolute Maximum Rating System (IEC 134). Stress above one or more of the limiting values may cause permanent damage to the device. These are stress ratings only and operation of the device at these or at any other conditions above those given in the Characteristics sections of the specification is not implied. Exposure to limiting values for extended periods may affect device reliability.	
Application information	
Where application information is given, it is advisory and does not form part of the specification.	

LIFE SUPPORT APPLICATIONS

These products are not designed for use in life support appliances, devices, or systems where malfunction of these products can reasonably be expected to result in personal injury. Philips customers using or selling these products for use in such applications do so at their own risk and agree to fully indemnify Philips for any damages resulting from such improper use or sale.

Philips Semiconductors – a worldwide company

Argentina: see South America

Australia: 34 Waterloo Road, NORTH RYDE, NSW 2113,
Tel. (02) 805 4455, Fax. (02) 805 4466

Austria: Computerstr. 6, A-1101 WIEN, P.O. Box 213,
Tel. (01) 60 101-1256, Fax. (01) 60 101-1250

Belarus: Hotel Minsk Business Center, Bld. 3, r. 1211,
Volodarski Str. 6, 220050 MINSK,
Tel. (172) 200 733, Fax. (172) 200 773

Belgium: see The Netherlands

Brazil: see South America

Bulgaria: Philips Bulgaria Ltd., Energoproject, 15th floor,
51 James Bourchier Blvd., 1407 SOFIA,
Tel. (359) 2 689 211, Fax. (359) 2 689 102

Canada: PHILIPS SEMICONDUCTORS/COMPONENTS:
Tel. (800) 234-7381, Fax. (708) 296-8556

Chile: see South America

China/Hong Kong: 501 Hong Kong Industrial Technology Centre,
72 Tat Chee Avenue, Kowloon Tong, HONG KONG,
Tel. (852) 2319 7888, Fax. (852) 2319 7700

Colombia: see South America

Czech Republic: see Austria

Denmark: Prags Boulevard 80, PB 1919, DK-2300
COPENHAGEN S, Tel. (032) 88 2636, Fax. (031) 57 1949

Finland: Sinikalliontie 3, FIN-02630 ESPOO,
Tel. (358) 0-615 800, Fax. (358) 0-61580 920

France: 4 Rue du Port-aux-Vins, BP317,
92156 SURESNES Cedex,
Tel. (01) 4099 6161, Fax. (01) 4099 6427

Germany: P.O. Box 10 51 40, 20035 HAMBURG,
Tel. (040) 23 53 60, Fax. (040) 23 53 63 00

Greece: No. 15, 25th March Street, GR 17778 TAVROS,
Tel. (01) 4894 339/4894 911, Fax. (01) 4814 240

Hungary: see Austria

India: Philips INDIA Ltd, Shivsagar Estate, A Block,
Dr. Annie Besant Rd. Worli, BOMBAY 400 018
Tel. (022) 4938 541, Fax. (022) 4938 722

Indonesia: see Singapore

Ireland: Newstead, Clonskeagh, DUBLIN 14,
Tel. (01) 7640 000, Fax. (01) 7640 200

Israel: RAPAC Electronics, 7 Kehilat Saloniki St, TEL AVIV 61180,
Tel. (03) 645 04 44, Fax. (03) 648 10 07

Italy: PHILIPS SEMICONDUCTORS,
Piazza IV Novembre 3, 20124 MILANO,
Tel. (0039) 2 6752 2531, Fax. (0039) 2 6752 2557

Japan: Philips Bldg 13-37, Kohnan 2-chome, Minato-ku,
TOKYO 108, Tel. (03) 3740 5130, Fax. (03) 3740 5077

Korea: Philips House, 260-199 Itaewon-dong,
Yongsan-ku, SEOUL, Tel. (02) 709-1412, Fax. (02) 709-1415

Malaysia: No. 76 Jalan Universiti, 46200 PETALING JAYA,
SELANGOR, Tel. (03) 750 5214, Fax. (03) 757 4880

Mexico: 5900 Gateway East, Suite 200, EL PASO,
TEXAS 79905, Tel. 9-5(800) 234-7831, Fax. (708) 296-8556

Middle East: see Italy

Netherlands: Postbus 90050, 5600 PB EINDHOVEN, Bldg. VB,
Tel. (040) 2783749, Fax. (040) 2788399

New Zealand: 2 Wagener Place, C.P.O. Box 1041, AUCKLAND,
Tel. (09) 849-4160, Fax. (09) 849-7811

Norway: Box 1, Manglerud 0612, OSLO,
Tel. (022) 74 8000, Fax. (022) 74 8341

Philippines: PHILIPS SEMICONDUCTORS PHILIPPINES Inc.,
106 Valero St. Salcedo Village, P.O. Box 2108 MCC,
MAKATI, Metro MANILA,
Tel. (63) 2 816 6380, Fax. (63) 2 817 3474

Poland: Ul. Lukiska 10, PL 04-123 WARSZAWA,
Tel. (022) 612 2831, Fax. (022) 612 2327

Portugal: see Spain

Romania: see Italy

Singapore: Lorong 1, Toa Payoh, SINGAPORE 1231,
Tel. (65) 350 2000, Fax. (65) 251 6500

Slovakia: see Austria

Slovenia: see Italy

South Africa: S.A. PHILIPS Pty Ltd.,
195-215 Main Road Martindale, 2092 JOHANNESBURG,
P.O. Box 7430 Johannesburg 2000,
Tel. (011) 470-5911, Fax. (011) 470-5494

South America: Rua do Rocio 220 - 5th floor, Suite 51,
CEP: 04552-903-SÃO PAULO-SP, Brazil,
P.O. Box 7383 (01064-970),
Tel. (011) 821-2333, Fax. (011) 829-1849

Spain: Balmes 22, 08007 BARCELONA,
Tel. (03) 301 6312, Fax. (03) 301 4107

Sweden: Kottbygatan 7, Akalla. S-16485 STOCKHOLM,
Tel. (0) 8-632 2000, Fax. (0) 8-632 2745

Switzerland: Allmendstrasse 140, CH-8027 ZÜRICH,
Tel. (01) 488 2211, Fax. (01) 481 77 30

Taiwan: PHILIPS TAIWAN Ltd., 23-30F, 66,
Chung Hsiao West Road, Sec. 1, P.O. Box 22978,
TAIPEI 100, Tel. (886) 2 382 4443, Fax. (886) 2 382 4444

Thailand: PHILIPS ELECTRONICS (THAILAND) Ltd.,
209/2 Sanpavuth-Bangna Road Prakanong, BANGKOK 10260,
Tel. (66) 2 745-4090, Fax. (66) 2 398-0793

Turkey: Talatpasa Cad. No. 5, 80640 GÜLTEPE/ISTANBUL,
Tel. (0212) 279 2770, Fax. (0212) 282 6707

Ukraine: PHILIPS UKRAINE,
2A Akademika Koroleva str. Office 165, 252148 KIEV,
Tel. 380-44-4760297, Fax. 380-44-4766991

United Kingdom: Philips Semiconductors LTD.,
276 Bath Road, Hayes, MIDDLESEX UB3 5BX,
Tel. (0181) 730-5000, Fax. (0181) 754-8421

United States: 811 East Arques Avenue, SUNNYVALE,
CA 94088-3409, Tel. (800) 234-7381, Fax. (708) 296-8556

Uruguay: see South America

Vietnam: see Singapore

Yugoslavia: PHILIPS, Trg N. Pasica 5/v, 11000 BEOGRAD,
Tel. (381) 11 825 344, Fax. (359) 211 635 777

Internet: <http://www.semiconductors.philips.com/ps/>

For all other countries apply to: Philips Semiconductors,
Marketing & Sales Communications, Building BE-p,
P.O. Box 218, 5600 MD EINDHOVEN, The Netherlands,
Fax. +31-40-2724825

SCDS48

© Philips Electronics N.V. 1996

All rights are reserved. Reproduction in whole or in part is prohibited without the prior written consent of the copyright owner.

The information presented in this document does not form part of any quotation or contract, is believed to be accurate and reliable and may be changed without notice. No liability will be accepted by the publisher for any consequence of its use. Publication thereof does not convey nor imply any license under patent- or other industrial or intellectual property rights.

Printed in The Netherlands

517021/1200/04/pp16

Date of release: 1996 May 14

Document order number:

9397 750 00844