

AM-FM QUALITY RADIO

The TDA1220B is a monolithic integrated circuit in a 16-lead dual in-line package.

It is intended for quality receivers produced in large quantities.

The functions incorporated are:

AM SECTION

- Preamp and double balanced mixer
- One pin local oscillator
- IF amplifier with internal AGC
- Detector and audio preamplifier

FM SECTION

- IF amplifier and limiter
- Quadrature detector
- Audio preamplifier

The TDA1220B is suitable up to 30MHz AM and for FM bands (including 450KHz narrow band) and features:

- Very constant characteristics (3V to 16V)
- High sensitivity and low noise
- Very low tweet

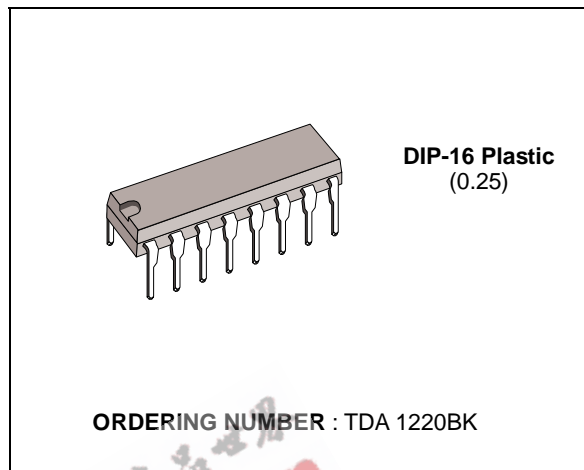

- Sensitivity regulation facility (*)
- High recovered audio signal suited for stereo decoders and radio recorders
- Very simple DC switching of AM-FM
- Low current drain
- AFC facility

(*) Maximum AM sensitivity can be reduced by means of a resistor (5 to 12K Ω) between pin 4 and ground.

BLOCK DIAGRAM

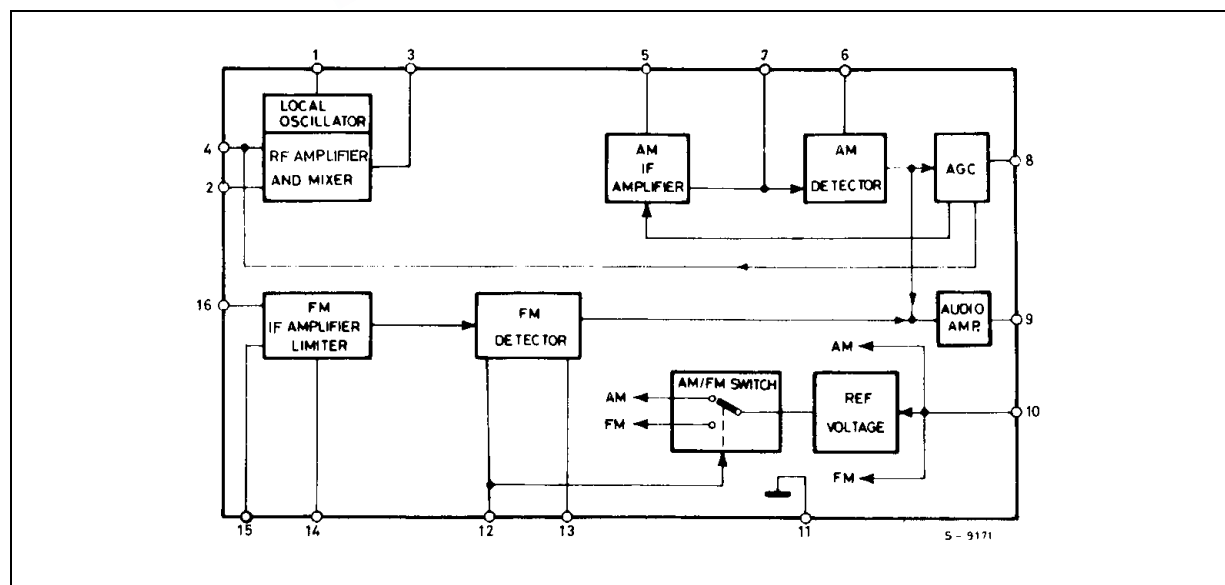

TDA1220B

ABSOLUTE MAXIMUM RATINGS

Symbol	Parameter	Value	Unit
V_s	Supply voltage	16	V
P_{tot}	Total power dissipation at $T_{amb} < 110^{\circ}\text{C}$	400	mW
T_{op}	Operating temperature	-20 to 85	$^{\circ}\text{C}$
T_{stg}, T_j	Storage and junction temperature	-55 to 150	$^{\circ}\text{C}$

PIN CONNECTION

(Top view)

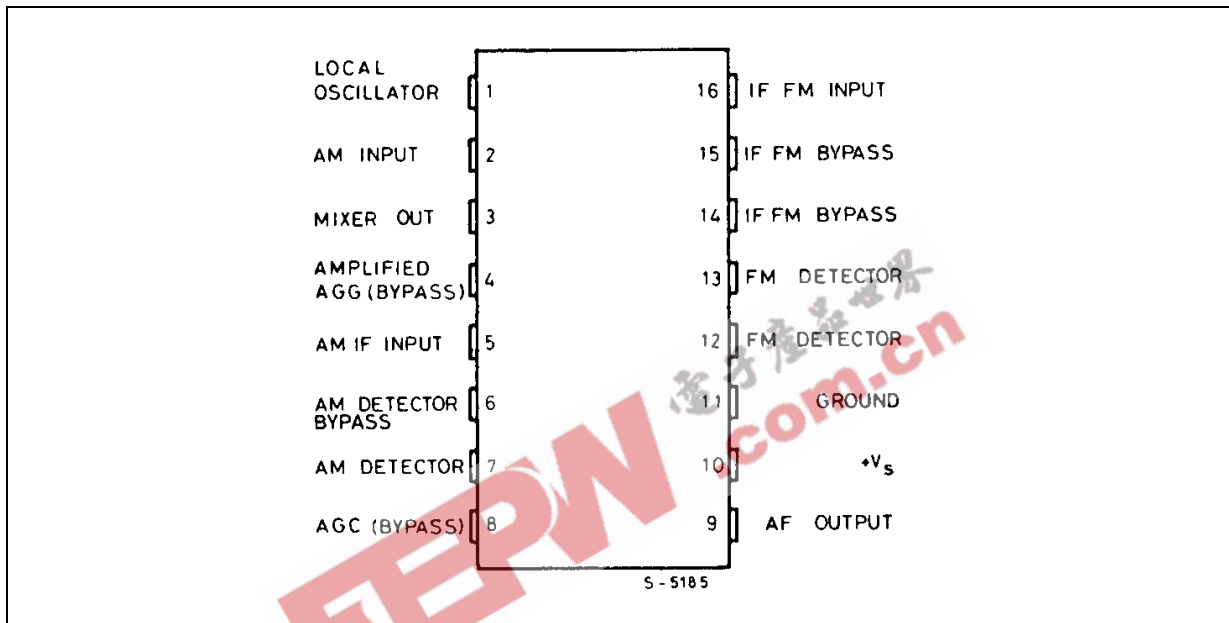

THERMAL DATA

Symbol	Parameter	Value	Unit
$R_{th-j-amb}$	Thermal resistance junction-ambient	max 100	$^{\circ}\text{C}/\text{W}$

ELECTRICAL CHARACTERISTICS ($T_{amb} = 25\text{ }^{\circ}\text{C}$, $V_s = 9\text{V}$ unless otherwise specified, refer to test circuit)

Symbol	Parameter	Test conditions	Min.	Typ.	Max.	Unit
V_s	Supply voltage		3		16	V
I_d	Drain current	FM		10	15	mA
		AM		14	20	mA

AM SECTION ($f_o = 1\text{ MHz}$; $f_m = \text{KHz}$)

V_i	Input sensitivity	S/N = 26 dB	$m = 0.3$		12	25	μV
S/N		$V_i = 10\text{ mV}$	$m = 0.3$	45	52		dB
V_i	AGC range	$\Delta V_{out} = 10\text{ dB}$	$m = 0.8$	94	100		dB
V_o	Recovered audio signal (pin 9)	$V_i = 1\text{ mV}$	$m = 0.3$	80	130	200	mV
d	Distortion	$V_i = 1\text{ mV}$	$m = 0.3$		0.4	1	%
			$m = 0.8$		1.2		%
V_H	Max input signal handling capability	$m = 0.8$	$d < 10\%$	1			V
R_i	Input resistance between pins 2 and 4	$m = 0$			7.5		$\text{K}\Omega$
C_i	Input capacitance between pins 2 and 4	$m = 0$			18		pF
R_o	Output resistance (pin 9)			4.5	7	9.5	$\text{K}\Omega$
	Tweet 2 IF	$m = 0.3$	$V_i = 1\text{ mV}$		40		dB
	Tweet 3 IF				55		dB

FM SECTION ($f_o = 10.8\text{ MHz}$; $f_m = 1\text{ KHz}$)

V_i	Input limiting voltage	-3 dB limiting point			22	36	μV
AMR	Amplitude modulation rejection	$\Delta f = \pm 22.5\text{ KHz}$	$m = 0.3$	40	50		dB
		$V_i = 3\text{ mV}$					
S/N	Ultimate quieting	$\Delta f = \pm 22.5\text{ KHz}$	$V_i = 1\text{ mV}$	55	65		dB
d	Distortion	$\Delta f = \pm 75\text{ KHz}$	$V_i = 1\text{ mV}$		0.7	1.5	%
d	Distortion	$\Delta f = \pm 22.5\text{ KHz}$	$V_i = 1\text{ mV}$		0.25	0.5	%
d	Distortion (double tuned)				0.1		%
V_o	Recovered audio signal (pin 9)	$\Delta f = \pm 22.5\text{ KHz}$	$V_i = 1\text{ mV}$	80	110	140	mV
R_i	Input resistance between pin 16 and ground				6.5		$\text{K}\Omega$
C_i	Input capacitance between pin 16 and ground				14		pF
R_o	Output resistance (pin 9)			4.5	7	9.5	$\text{K}\Omega$

Figure 1. Test circuit

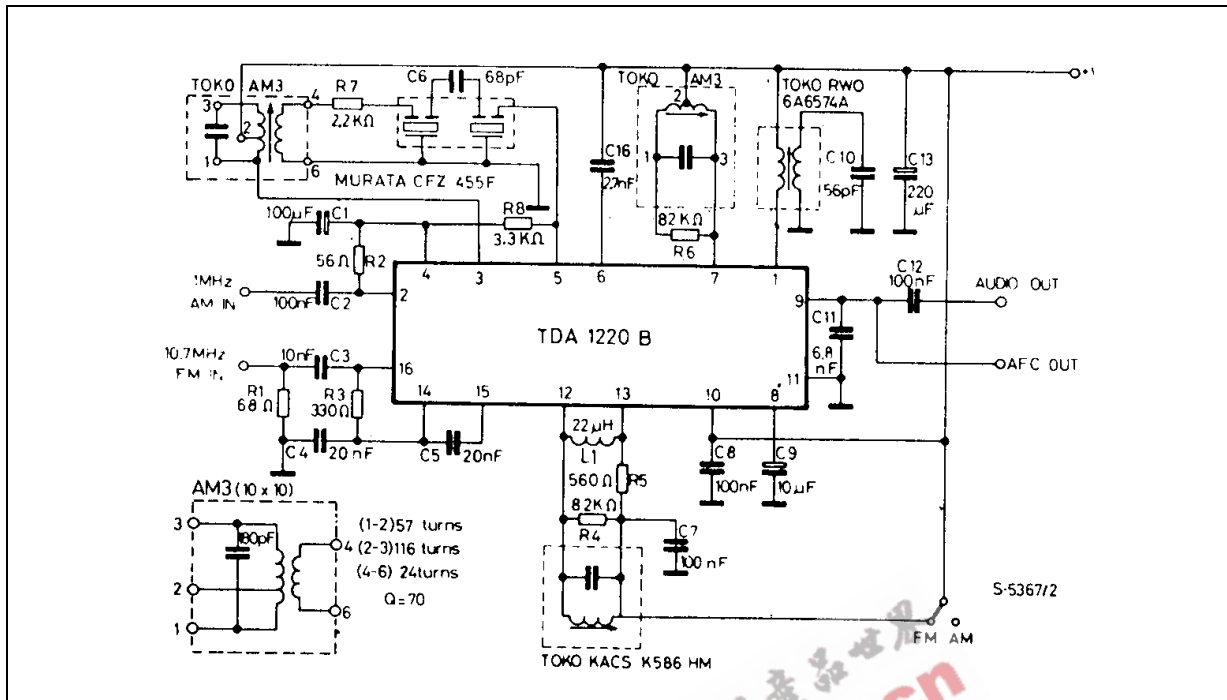

Figure 2. PC board and component layout (1:1 scale) of the test circuit

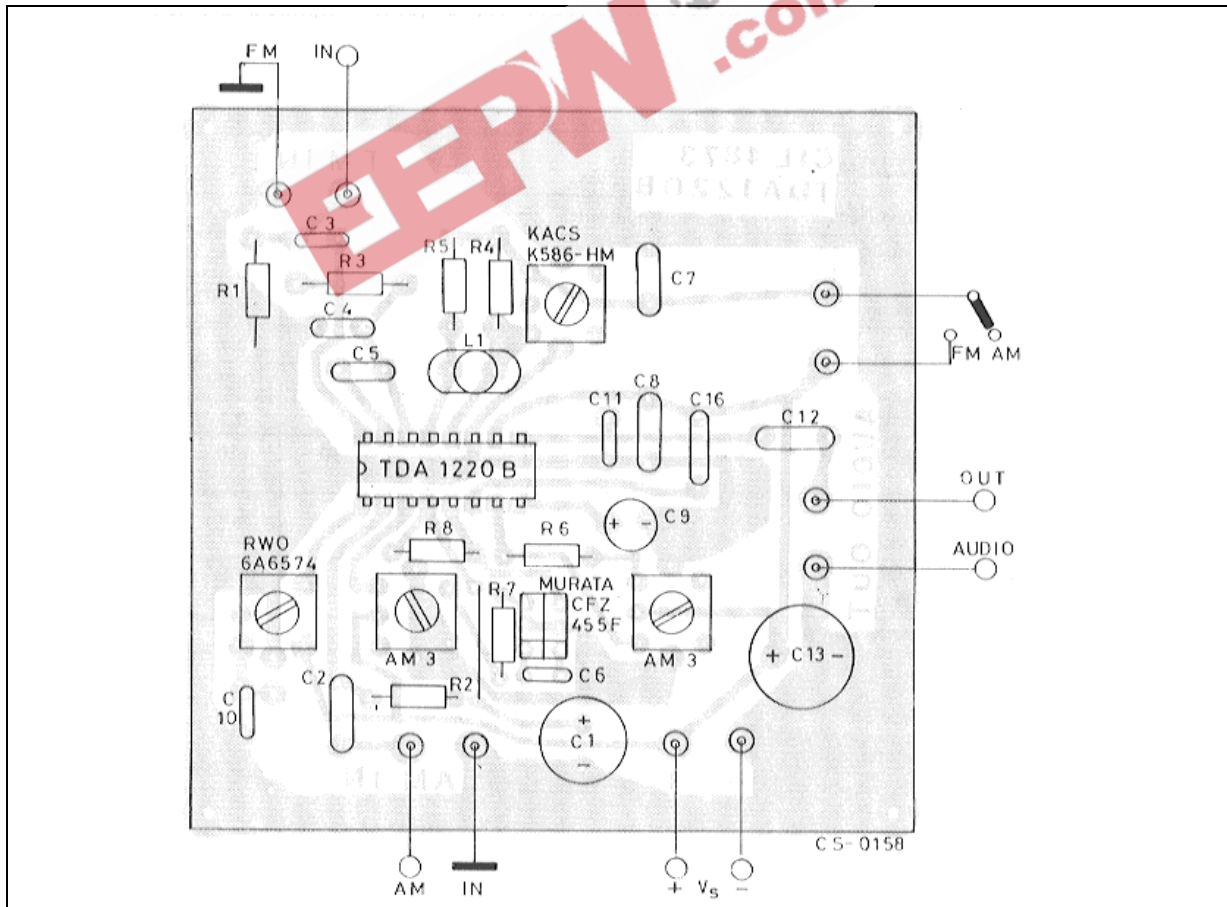

Figure 3. Audio output, noise and tweet levels vs. input signal (AM section)

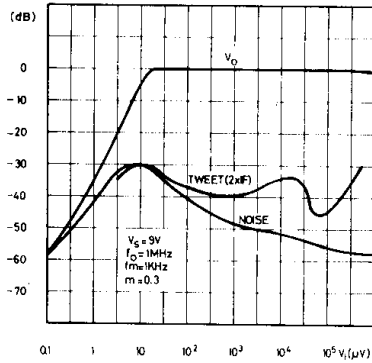

Figure 4. Distortion vs. input signal and modulation index (AM section)

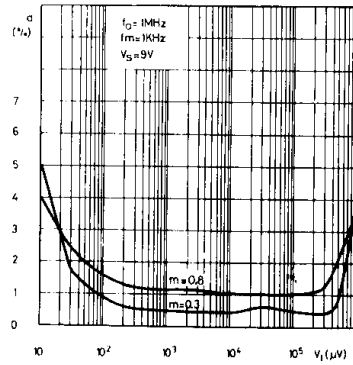

Figure 5. Audio output vs. supply voltage (AM section)

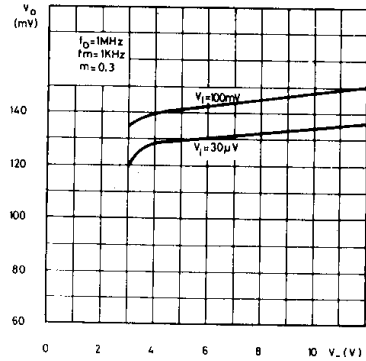

Figure 6. Audio output and noise level vs. input signal (FM section)

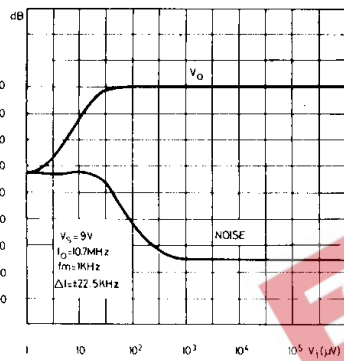

Figure 7. Distortion vs. input signal (FM section)

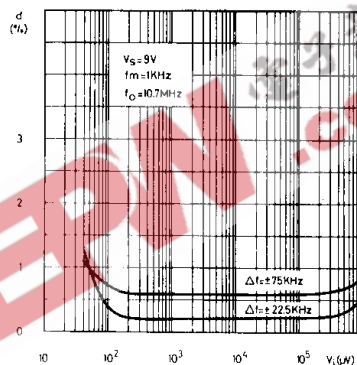

Figure 8. Audio output vs. supply voltage (FM section)

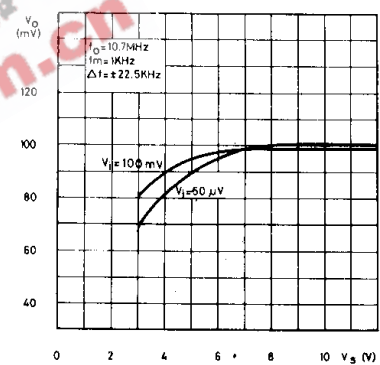

Figure 9. Amplitude modulation rejection vs. input signal (FM section)

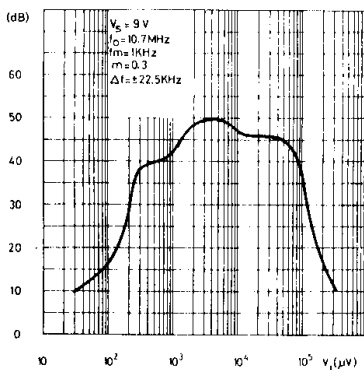

Figure 10. Δ DC output voltage (pin. 9) vs. frequency shift (FM section)

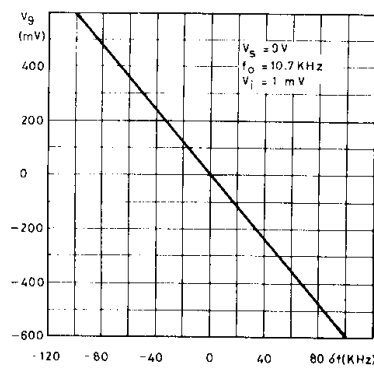
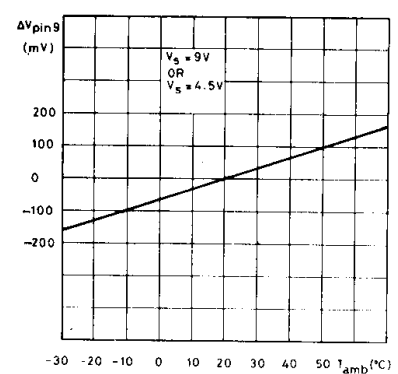

Figure 11. Δ DC output voltage (pin 9) vs. ambient temperature (FM section)



APPLICATION INFORMATION

AM Section

RF Amplifier and mixer stages

The RF amplifier stage (pin 2) is connected directly to the secondary winding of the ferrite rod antenna or input tuned circuit. Bias is provided at pin 4 which must be adequately decoupled. The RF amplifier provides stable performance extending beyond 30 MHz.

The Mixer employed is a double - balanced multiplier and the IF output at pin 3 is connected directly to the IF filter coil.

Local oscillator

The local oscillator is a cross coupled differential stage which oscillates at the frequency determined by the load on pin 1.

The oscillator resonant circuit is transformer coupled to pin 1 to improve the **Q** factor and frequency stability. The oscillator level at pin 1 is about 100 mV rms and the performance extends beyond 30 MHz, however to enhance the stability and reduce to a minimum pulling effects of the AGC operation or supply voltage variations, a high C/L ratio should be used above 10 MHz.

An external oscillator can be injected at pin 1. The level should be 50 mV rms and pin 1 should be connected to the supply via a 100W resistor.

IF Amplifier Detector

The IF amplifier is a wide band amplifier with a tuned output stage.

The IF filters can be either LC or mixed LC/ceramic.

AM detection occurs at pin 7. A detection capacitor is connected to pin 6 to reduce the radiation of spurious detector products.

The Audio output is at pin 9 (for either AM or FM); the IF frequency is filtered by an external capacitor which is also used as the FM mono de-emphasis network. The audio output impedance is about 7K Ω and a high impedance load (~ 50K Ω) must be used.

AGC

Automatic gain control operates in two ways.

With weak signals it acts on the IF gain, maintaining the maximum S/N. For strong signals a second circuit intervenes which controls the entire chain and allows signal handling in excess of one volt ($m = 0.8$).

At pin 8 there is a carrier envelope signal which is filtered by an external capacitor to remove the Audio and RF content and obtain a mean DC signal to drive the AGC circuit.

APPLICATION INFORMATION (continued)**FM Section****IF Amplifier and limiter**

The 10.7 MHz IF signal from the ceramic filter is amplified and limited by a chain of four differential stages. Pin 16 is the amplifier input and has a typical input impedance of 6.5 k Ω in parallel with 14 pF at 10.7 MHz. Bias for the first stage is available at pin 14 and provides 100% DC feedback for stable operating conditions. Pin 15 is the second input to the amplifier and is decoupled to pin 14, which is grounded by a 20 nF capacitor. An RLC network is connected to the amplifier output and gives a 90° phase shift (at the IF centre frequency) between pins 13 and 12. The signal level at pin 13 is about 150 mV rms

FM Detector

The circuit uses a quadrature detector and the choice of component values is determined by the acceptable level of distortion at a given recovered audio level.

With a double tuned network the linearity improves (distortion is reduced) and the phase shift can be optimized; however this leads to a reduction in the level of the recovered audio. A satisfactory compromise for most FM receiver applications is shown in the test circuit.

Care should be taken with the physical layout.

The main recommendations are:

- Locate the phase shift coil as near as possible to pin 13.
- Shunt pins 14 and 16 with a low value resistor (between 56 Ω and 330 Ω).
- Ground the decoupling capacitor of pin 14 and the 10.7 MHz input filter at the same point.

AM-FM Switching

AM-FM switching is achieved by applying a DC voltage at pin 13, to switch the internal reference.

Typical DC voltages (refer to the test circuit)

Pins	1	2	3	4	5	6	7	8	9	10	11	12	13	14	15	16	Unit
AM	9	1.4	9	1.4	1.4	8.4	9	0.7	1.9	9	0	0.1	0.1	8.5	8.5	8.5	V
FM	9	0.02	9	0.02	0.02	8.5	9	0	1.7	9	0	9	9	8	8	8	V

APPLICATION SUGGESTION

Recommended values are referred to the test circuit of Fig. 2.

Part number	Recommended value	Purpose	Smaller than recommended value	Larger than recommended value
C1	100 μ F	AGC bypass	Increase of the distortion at low audio frequency	Increase of the AGC time constant
C2 (*)	100 nF	AM input DC cut		
C3 (*)	10 nF	FM input DC cut		
C4 C5	20 nF 20 nF	FM amplifier bypass	Reduction of sensitivity	– Bandwidth increase – Higher noise
C6	68 pF	Ceramic filter coupling	IF bandwidth reduction	IF bandwidth increase
C7	100 nF	FM detector decoupling	Danger of RF irradiation	
C8	100 nF	Power supply bypass	Noise increase of the audio output	
C9	10 μ F	AGC bypass	Increase of the distortion at low audio frequency	Increase of the AGC time constant
C10 (*)	56 pF	Tuning of the AM oscillator at 1455 KHz		
C11	6.8 nF	50 μ s FM de-emphasis		
C12	100 nF	Output DC decoupling	Low audio frequency cut	
C13	220 μ F	Power supply decoupling	Increase of the distortion at low frequency	
C16	2.7 nF	AM detector capacitor	Low suppression of the IF frequency and harmonics	Increase of the audio distortion
R1 (*)	68 ohm	FM input matching		
R2 (*)	56 ohm	AM input matching		
R3	330 ohm	Ceramic filter matching	Audio output decrease and lower distortion	
R4	8.2 Kohm	FM detector coil Q setting	Audio output decrease and higher AMR	Audio output increase and higher distortion
R5	560 ohm	FM detector load resistor	Lower IF gain and Lower AGC range	
R6	82 Kohm	AM detector coil Q setting		Higher IF gain and lower AGC range
R7	2.2 Kohm	455 KHz IF filter matching		
R8	3.3 Kohm	455 KHz IF filter matching		

(*) Only for test circuit

APPLICATION INFORMATION (continued)

Figure 12. Portable AM/FM radio

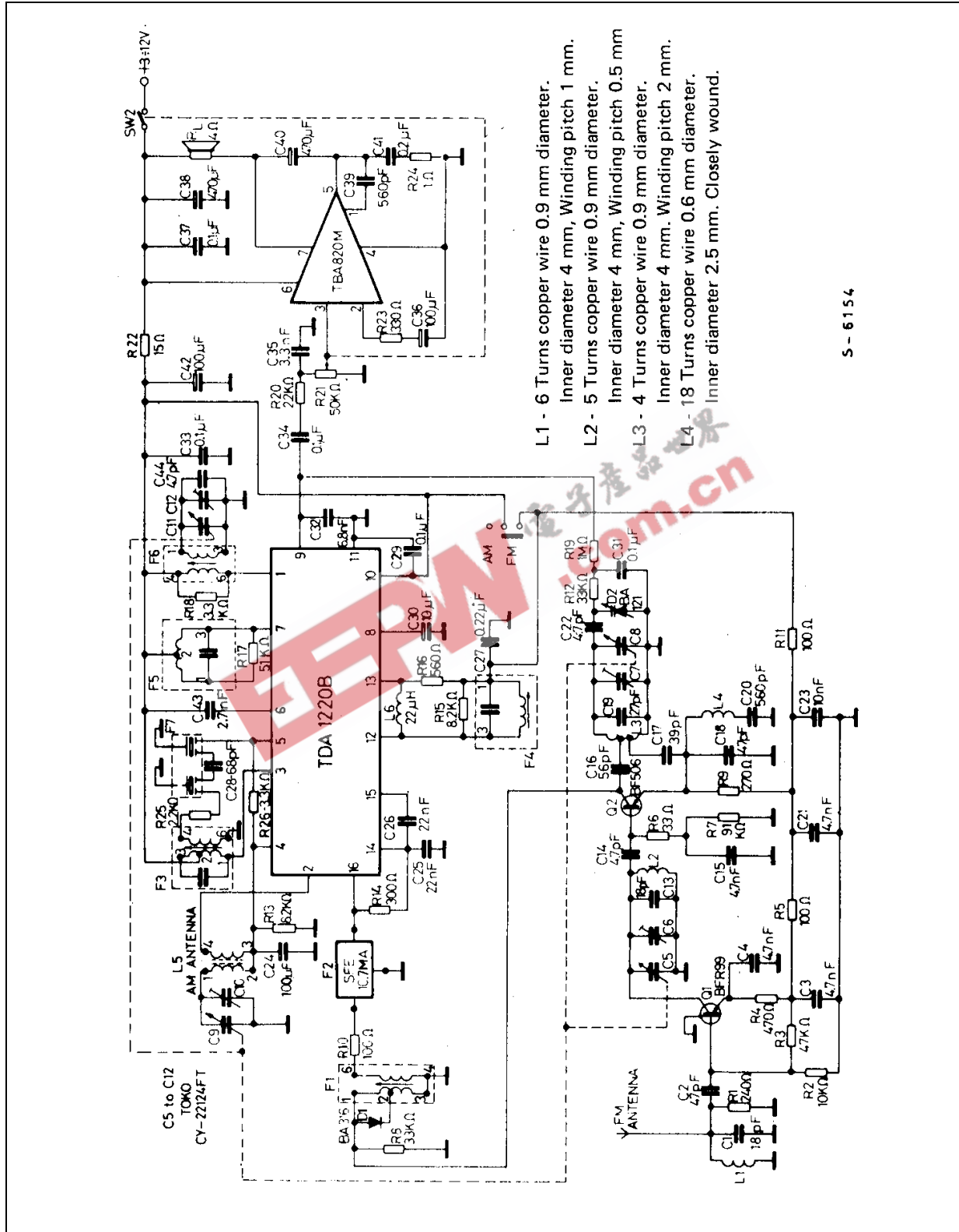

- L1 - 6 Turns copper wire 0.9 mm diameter.
Inner diameter 4 mm, Winding pitch 1 mm.
- L2 - 5 Turns copper wire 0.9 mm diameter.
Inner diameter 4 mm, Winding pitch 0.5 mm
- L3 - 4 Turns copper wire 0.9 mm diameter.
Inner diameter 4 mm.
- L4 - 18 Turns copper wire 0.6 mm diameter.
Inner diameter 2.5 mm. Closely wound.

S - 6154

APPLICATION INFORMATION (continued)

Figure 13. PC board and component layout of the fig. 12 1 : 1 scale

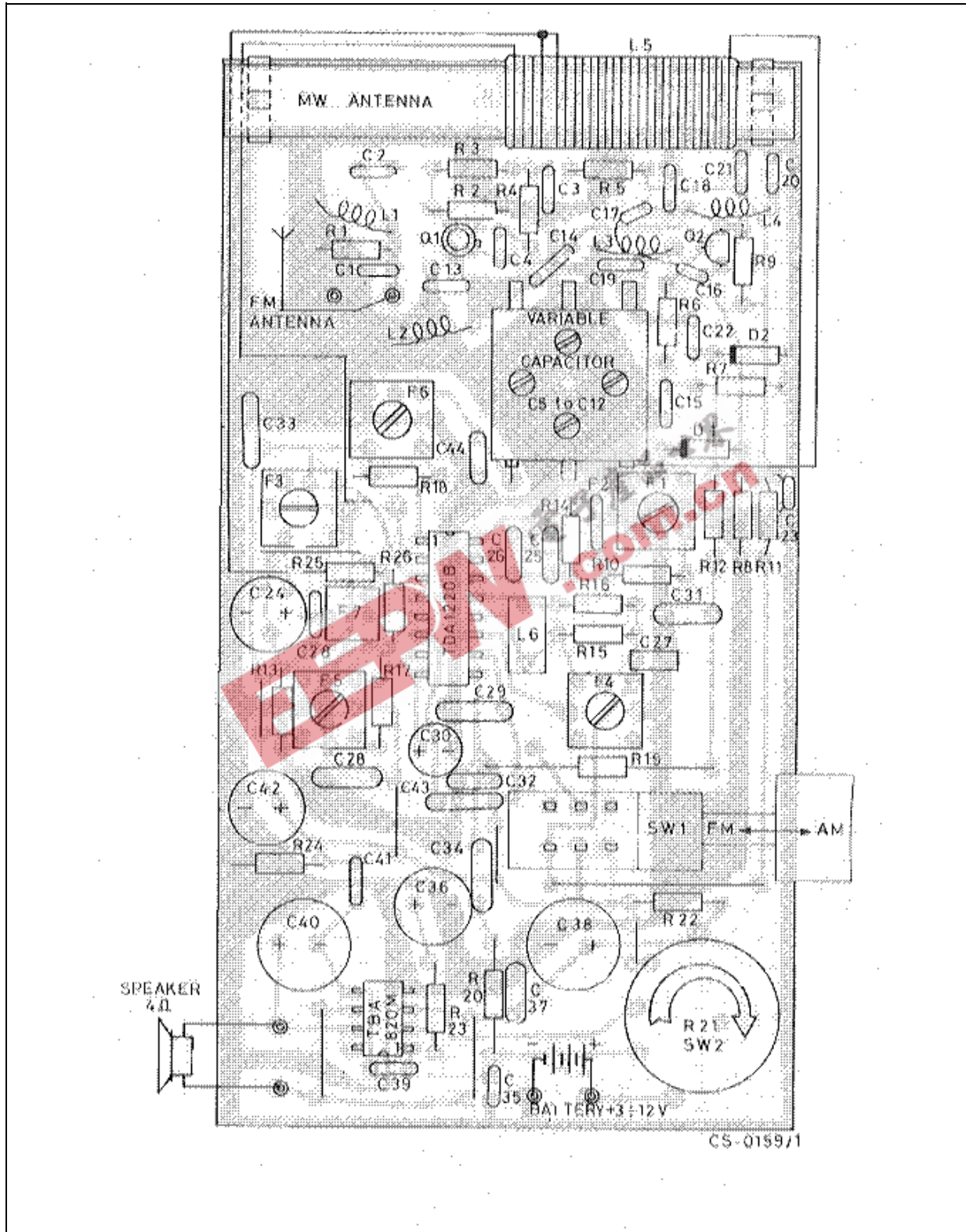

APPLICATION INFORMATION (continued)

F1 - 10.7 MHz IF Coil

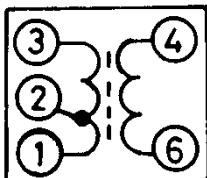

C _o (pF)	f (MHz)	Q _o	TURNS		
			1-2	2-3	4-6
–	–	1-3	1-2	2-3	4-6
–	10.7	110	6	8	2

TOKO - FM1 - 10x10 mm.
154 AN - 7A5965R

F3 and F5 - 455 KHz IF Coil

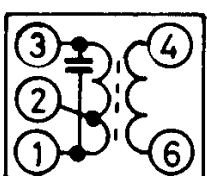

C _o (pF)	f (KHz)	Q _o	TURNS		
			1-2	2-3	4-6
1.3	–	1-3	1-2	2-3	4-6
180	455	70	57	116	24

TOKO - AM3 - 10x10 mm.
RLC - 4A7525N

F4 - FM Detector Coil

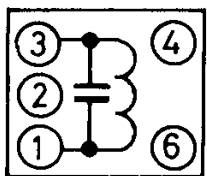

C _o (pF)	f (KHz)	Q _o	TURNS		
			1-3	–	–
1.3	–	1-3	1-3	–	–
82	10.7	100	12	–	–

TOKO - 10x10 mm.
KACS - K586 HM

F6 - AM Oscillator Coil

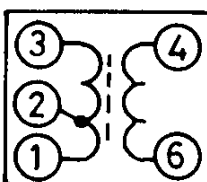

f (kHz)	L (μH) 1-3	Q _o	TURNS		
			1-2	2-3	4-6
796	220	80	2	75	8

TOKO - 10x10 mm.
RWO + 6A6574N

L5 - Antenna Coil

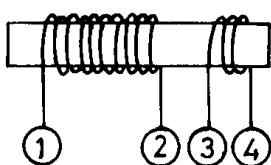

f (KHz)	L (μH)	Q _o	TURNS	
			1-2	3-4
796			105	7

WIRE: LITZ - 15x0.05 mm.
CORE: 10x80 mm.

TDA1220B

APPLICATION INFORMATION (continued)

Typical performance of the radio receiver of fig. 12 ($V_s = 9V$)

Parameter		Test Conditions		Value
WAVEBANDS	FM			87.5 to 108 MHz
	AM			510 to 1620 KHz
SENSITIVITY	FM	S/N = 26dB	$\Delta f = 22.5\text{KHz}$	1 μV
	AM	S/N = 6dB	m = 0.3	1 μV
	AM	S/N = 26dB	m = 0.3	10 μV
DISTORTION (fm = 1KHz)	FM	$P_o = 0.5W$	$\Delta f = 22.5\text{KHz}$	0.25%
			$\Delta f = 75\text{KHz}$	0,7%
	AM	$V_i = 100 \mu\text{V}$	m = 0.3	0.4%
			m = 0,8	0,8%
SIGNAL TO NOISE (fm = 1KHz)	FM	$P_o = 0.5W$ $V_i = 100 \mu\text{V}$	$\Delta f = 22.5\text{KHz}$	64 dB
	AM	$P_o = 0.5W$ $V_i = 1 \text{ mV}$	m = 0.3	50 dB
AMPLITUDE MODULATION REJECTION	FM	$V_i = 100 \mu\text{V}$	$\Delta f = 22.5\text{KHz}$ m = 0.3	50 dB
TWEET	2nd H.	f = 911 KHz		0.3%
	3rd H.	f = 1370 KHz		0.07%
QUIESCENT CURRENT				20 mA
SUPPLY VOLTAGE RANGE				3 to 12V

APPLICATION INFORMATION (continued)

Figure 14. Low cost 27 MHz receiver

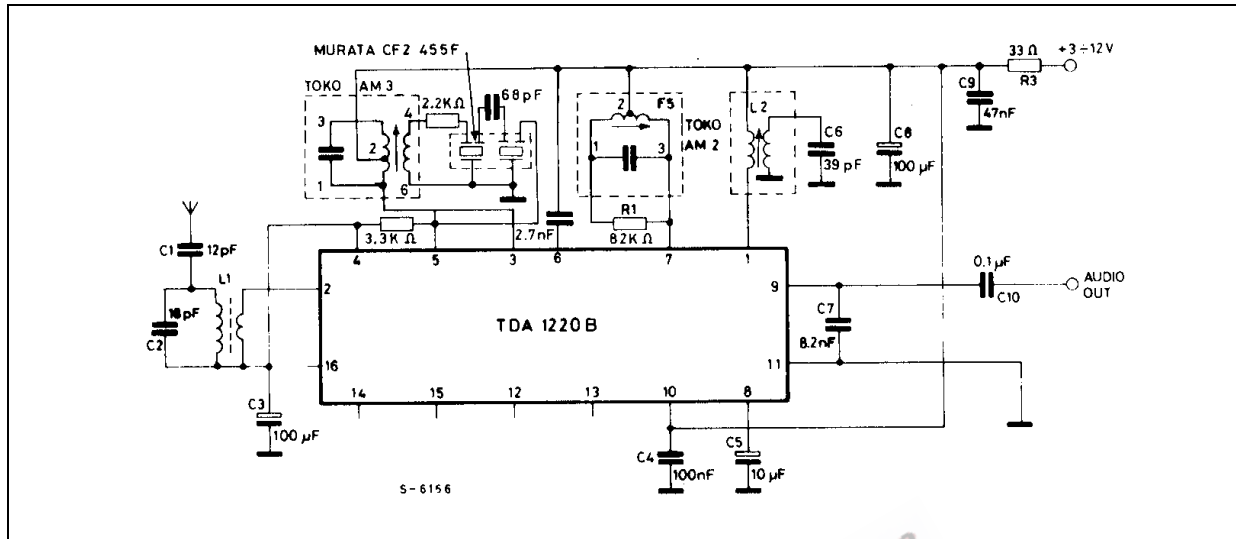
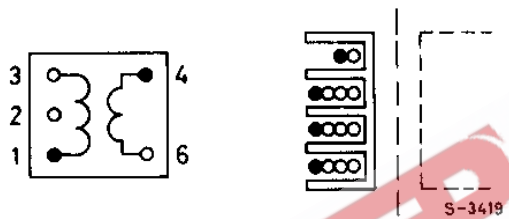
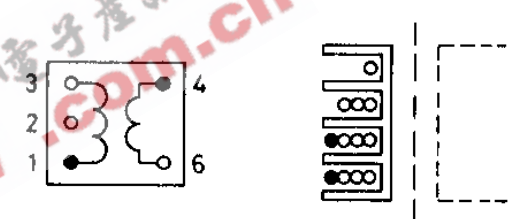

Figure 15. L2 Oscillator coil



Coil support: Toko 10K
 Primary winding: 10 Turns of enamelled copper wire 0.16 mm diameter (pins 3-1).
 Secondary winding: 4 Turns copper wire 0.16 mm diameter (pins 6-4)

Figure 16. L1 Antenna Coil



Coil support: Toko 10K
 Primary winding: as L2 (pins 3-1)
 Secondary winding: 2 Turns copper wire 0.16 mm diameter (pins 6-4)

Figure 17. Low cost 27 MHz receiver with external xtal oscillator

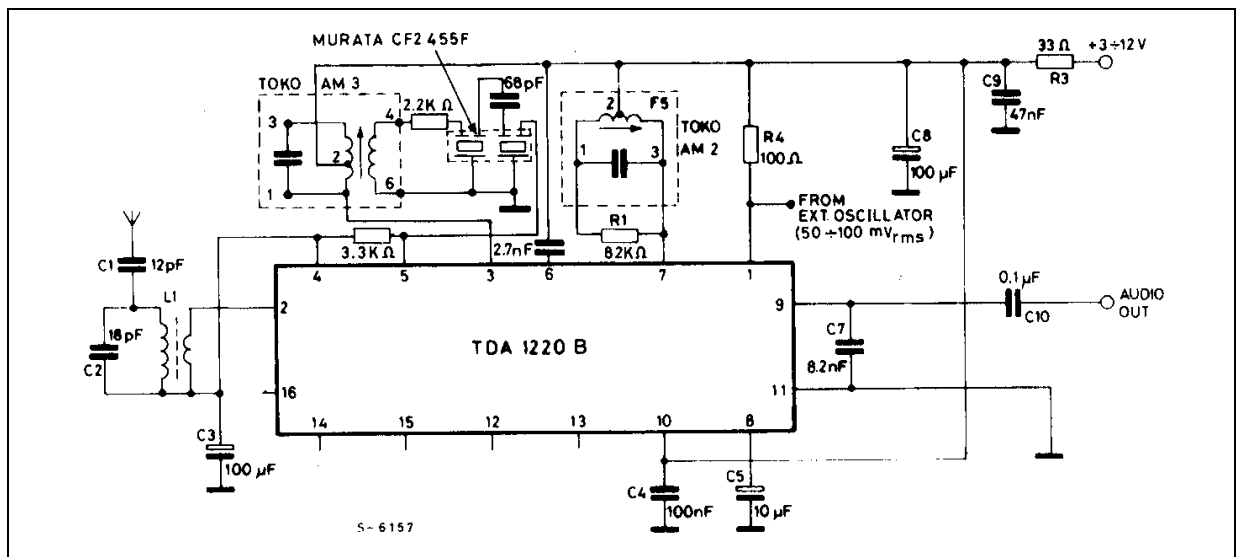

APPLICATION INFORMATION (continued)

Figure 18. 455 KHz FM narrow band IF

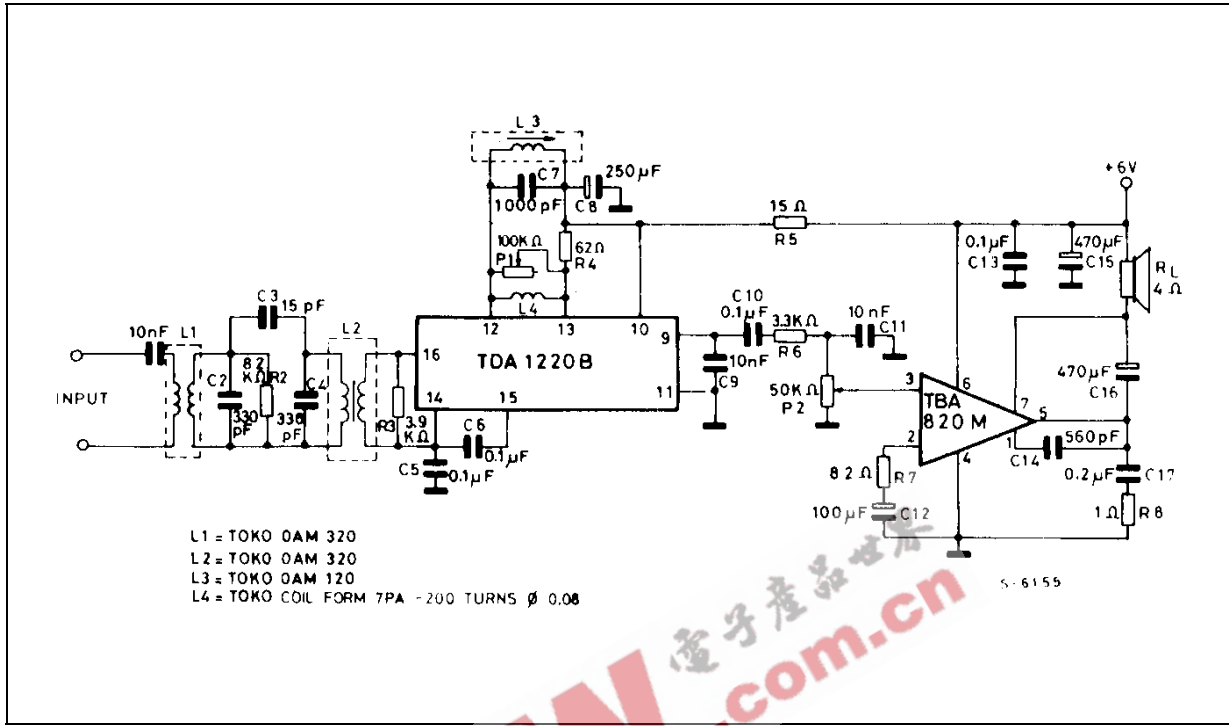
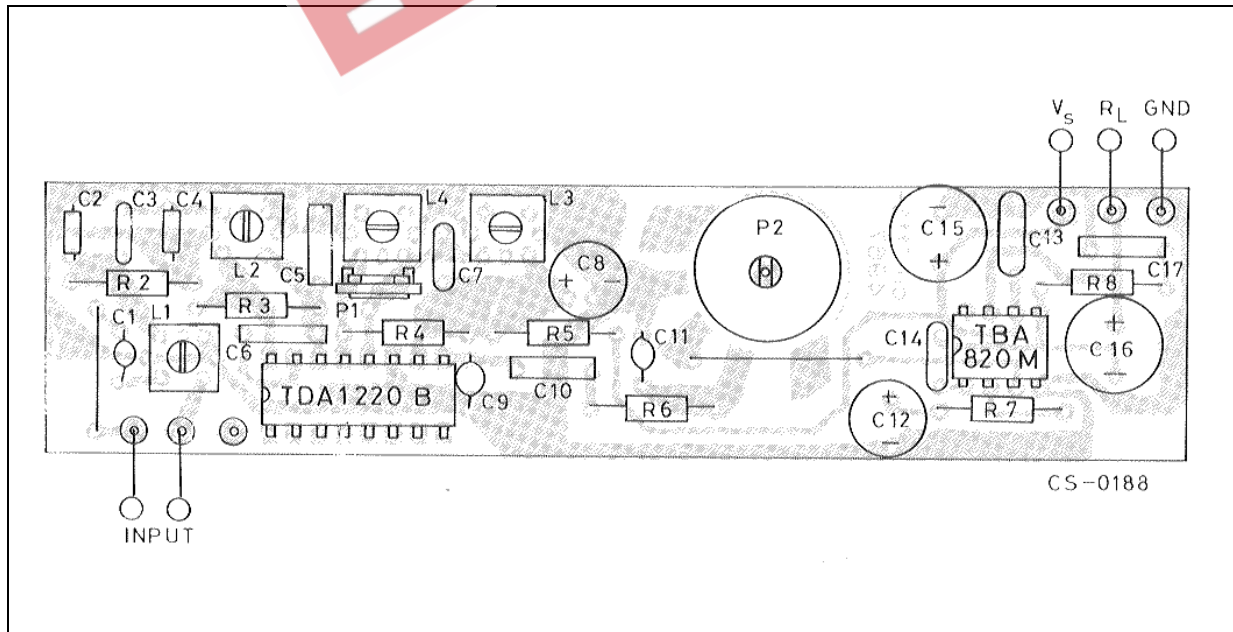

Figure 18. P.C. board and component layout of the circuit of fig. 18



APPLICATION INFORMATION (continued)

Figure 20. Discriminator "S" curve response (circuit of fig. 18)

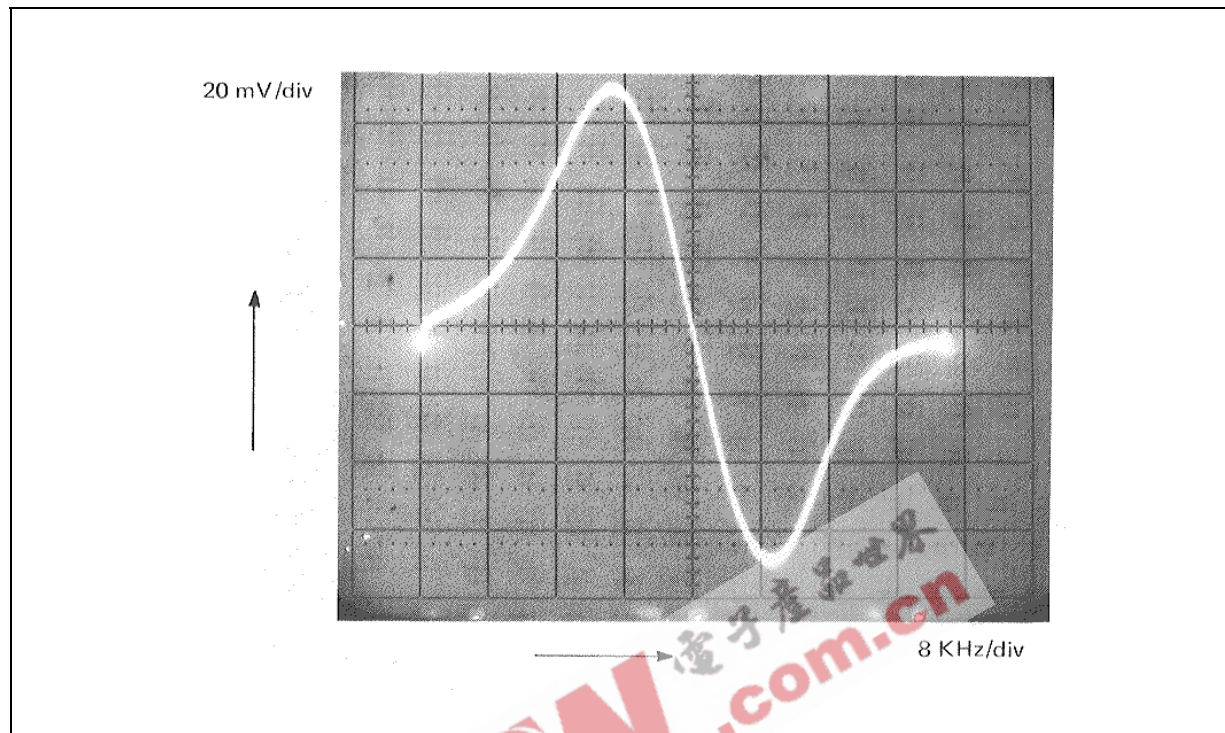
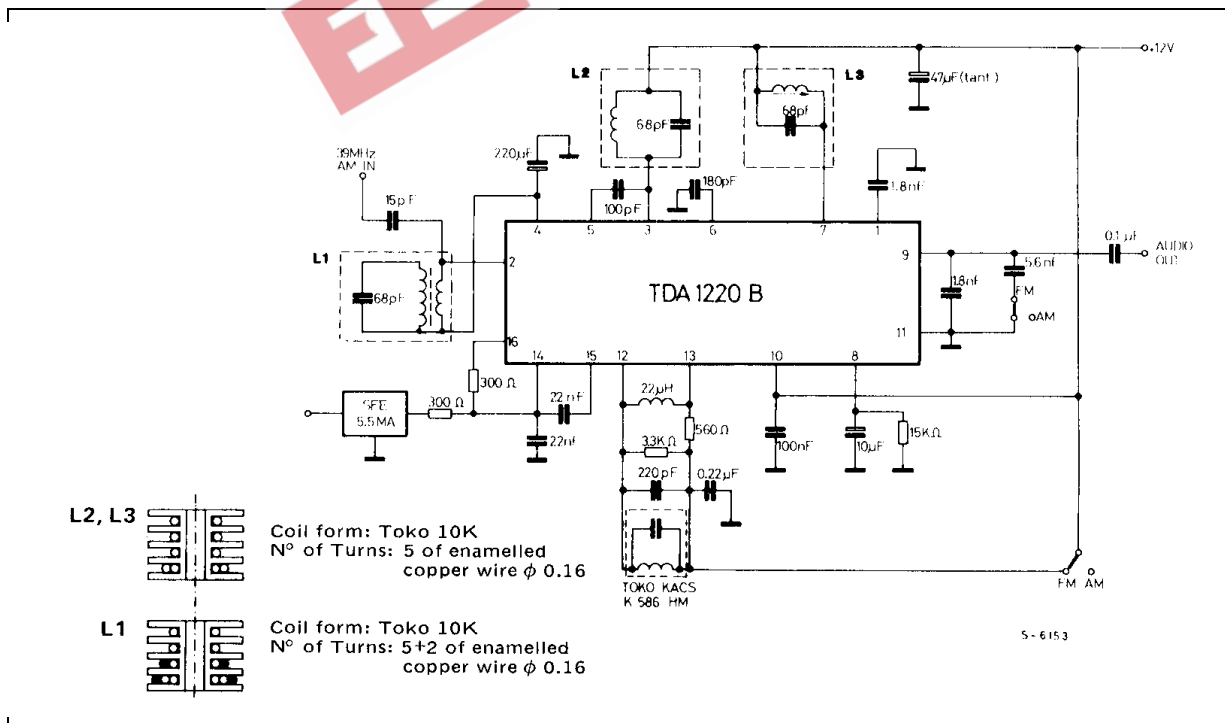

Figure 21. Application in sound channel of multistandard TV or in parallel AM modulated sound channel (AM section only).



TDA1220B

ELECTRICAL CHARACTERISTICS ($V_s = 12V$)

AM Section ($f_o = 39MHz$; $f_m = 15KHz$)

Parameter	Typ	Unit
Audio out ($m = 0.3$)	60	mV
S/N ($V_i = 100\text{ mV}$; $m = 0.3$)	37	dB
S/N ($V_i = 1\text{ mV}$; $m = 0.3$)	55	dB
S/N ($V_i = 10\text{ mV}$; $m = 0.3$)	56	dB
AGC range ($m = 0.8$, $\Delta V_{out} = 3\text{ dB}$)	65	dB
Max input signal handling ($m = 0.8$; $d = 5\%$)	150	mV
- 3dB bandwidth	600	KHz
Distortion ($V_i = 100\ \mu\text{V}$; $m = 0.3$)	2	%
($V_i = 1\text{ mV}$; $m = 0.3$)	1	%
($V_i = 10\text{ mV}$; $m = 0.3$)	0.8	%
($V_i = 100\ \mu\text{V}$; $m = 0.8$)	7	%
($V_i = 1\text{ mV}$; $m = 0.8$)	5	%
($V_i = 10\text{ mV}$; $m = 0.8$)	3	%

FM Section ($f_o = 5.5MHz$; $f_m = 1KHz$)

Parameter	Typ	Unit
-3dB input limiting voltage ($\Delta f = 25KHz$)	3	μV
AMR ($\Delta f = +25KHz$; $m = 0.3$; $V_i = 100\ \mu\text{V}$)	40	dB
($\Delta f = +25KHz$; $m = 0.3$; $V_i = 1\text{ mV}$)	58	dB
($\Delta f = +25KHz$; $m = 0.3$; $V_i = 10\text{ mV}$)	54	dB
S/N ($\Delta f = \pm 25KHz$; $V_i = 100\ \mu\text{V}$)	51	dB
S/N ($\Delta f = \pm 25KHz$; $V_i = 1\text{ mV}$)	70	dB
S/N ($\Delta f = \pm 25KHz$; $V_i = 10\text{ mV}$)	70	dB
Distortion ($\Delta f = \pm 25KHz$; $V_i = 100\ \mu\text{V}$)	0.5	%
($\Delta f = \pm 25KHz$; $V_i = 1\text{ mV}$)	0.6	%
($\Delta f = \pm 25KHz$; $V_i = 10\text{ mV}$)	0.6	%
($\Delta f = \pm 50KHz$; $V_i = 100\ \mu\text{V}$)	1	%
($\Delta f = \pm 50KHz$; $V_i = 1\text{ mV}$)	1	%
($\Delta f = \pm 50KHz$; $V_i = 10\text{ mV}$)	1	%
Recovered audio ($\Delta f = \pm 15KHz$; $V_i = 1\text{ mV}$) Recovered audio can be varied by variation of 3.3K ohm resistor in parallel with the discriminator coil)	70	mV
Max input signal handling	1	V

Note: AM performance at 39MHz can be improved by mean of a selective preamplifier stage.

DIP16 PACKAGE MECHANICAL DATA

DIM.	mm			inch		
	MIN.	TYP.	MAX.	MIN.	TYP.	MAX.
a1	0.51			0.020		
B	0.77		1.65	0.030		0.065
b		0.5			0.020	
b1		0.25			0.010	
D			20			0.787
E		8.5			0.335	
e		2.54			0.100	
e3		17.78			0.700	
F			7.1			0.280
l			5.1			0.201
L		3.3			0.130	
Z			1.27			0.050

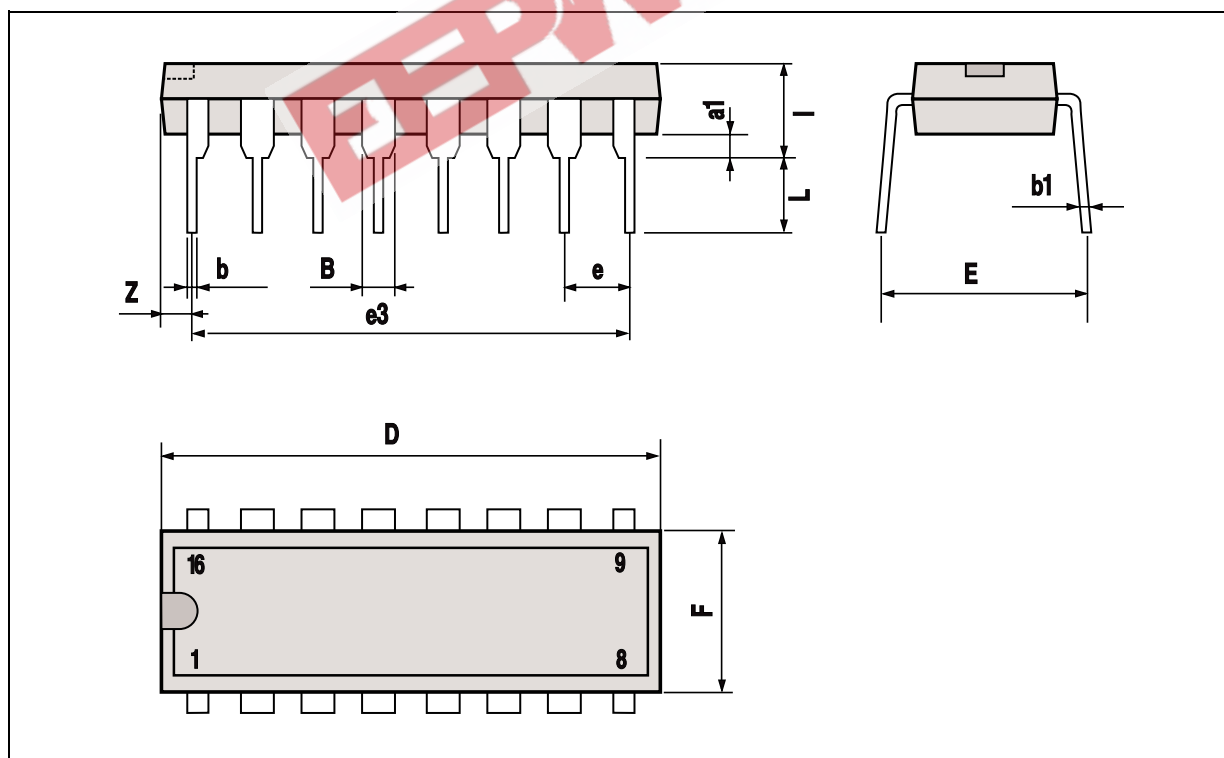

EEPW 电子产品世界
.com.cn

Information furnished is believed to be accurate and reliable. However, SGS-THOMSON Microelectronics assumes no responsibility for the consequences of use of such information nor for any infringement of patents or other rights of third parties which may result from its use. No license is granted by implication or otherwise under any patent or patent rights of SGS-THOMSON Microelectronics. Specifications mentioned in this publication are subject to change without notice. This publication supersedes and replaces all information previously supplied. SGS-THOMSON Microelectronics products are not authorized for use as critical components in life support devices or systems without express written approval of SGS-THOMSON Microelectronics.

© 1994 SGS-THOMSON Microelectronics - All Rights Reserved

SGS-THOMSON Microelectronics GROUP OF COMPANIES

Australia - Brazil - France - Germany - Hong Kong - Italy - Japan - Korea - Malaysia - Malta - Morocco - The Netherlands - Singapore - Spain - Sweden - Switzerland - Taiwan - Thailand - United Kingdom - U.S.A.