

# DATA SHEET

EEPW 电子產品世界  
.com.cn

## **TDA1074A**

Dual tandem electronic  
potentiometer circuit

Product specification  
File under Integrated Circuits, IC01

December 1982

## Dual tandem electronic potentiometer circuit

## TDA1074A

### GENERAL DESCRIPTION

The TDA1074A is a monolithic integrated circuit designed for use as volume and tone control circuit in stereo amplifiers. This dual tandem potentiometer IC consists of two ganged pairs of electronic potentiometers with the eight inputs connected via impedance converters, and the four outputs driving individual operational amplifiers. The setting of each electronic potentiometer pair is controlled by an individual d.c. control voltage. The potentiometers operate by current division between the arms of cross-coupled long-tailed pairs. The current division factor is determined by the level and polarity of the d.c. control voltage with respect to an externally available reference level of half the supply voltage. Since the electronic potentiometers are adjusted by a d.c. control voltage, each pair can be controlled by single linear potentiometers which can be located in any position dictated by the equipment styling. Since the input feedback impedances around the operational amplifier gain blocks are external, the TDA1074A can perform bass/treble and volume/loudness control. It also can be used as a low-level fader to control the sound distribution between the front and rear loudspeakers in car radio installations.

### Features

- High impedance inputs to both 'ends' of each electronic potentiometer
- Ganged potentiometers track within 0,5 dB
- Electronic rejection of supply ripple
- Internally generated reference level available externally so that the control voltage can be made to swing positively and negatively around a well-defined 0 V level
- The operational amplifiers have push-pull outputs for wide voltage swing and low current consumption
- The operational amplifier outputs are current limited to provide output short-circuit protection
- Although designed to operate from a 20 V supply (giving a maximum input and output signal level of 6 V), the TDA1074A can work from a supply as low as 7,5 V with reduced input and output signal levels.

### QUICK REFERENCE DATA

Supply voltage (pin 11)	$V_P$	typ.	20 V
Supply current (pin 11)	$I_P$	typ.	22 mA
Input signal voltage (r.m.s. value)	$V_{i(rms)}$	max.	6 V
Output signal voltage (r.m.s. value)	$V_{o(rms)}$	max.	6 V
Total harmonic distortion	THD	typ.	0,05 %
Output noise voltage (r.m.s. value)	$V_{no(rms)}$	typ.	50 $\mu$ V
Control range	$\Delta\alpha$	typ.	110 dB
Cross-talk attenuation (L/R)	$\alpha_{ct}$	typ.	80 dB
Ripple rejection (100 Hz)	$\alpha_{100}$	typ.	46 dB
Tracking of ganged potentiometers	$\Delta G_V$	typ.	0,5 dB
Supply voltage range	$V_P$		7,5 to 23 V
Operating ambient temperature range	$T_{amb}$		-30 to + 80 °C

### PACKAGE OUTLINE

18-lead DIL; plastic (SOT102); SOT102-1; 1996 July 18.

Dual tandem electronic potentiometer circuit

TDA1074A

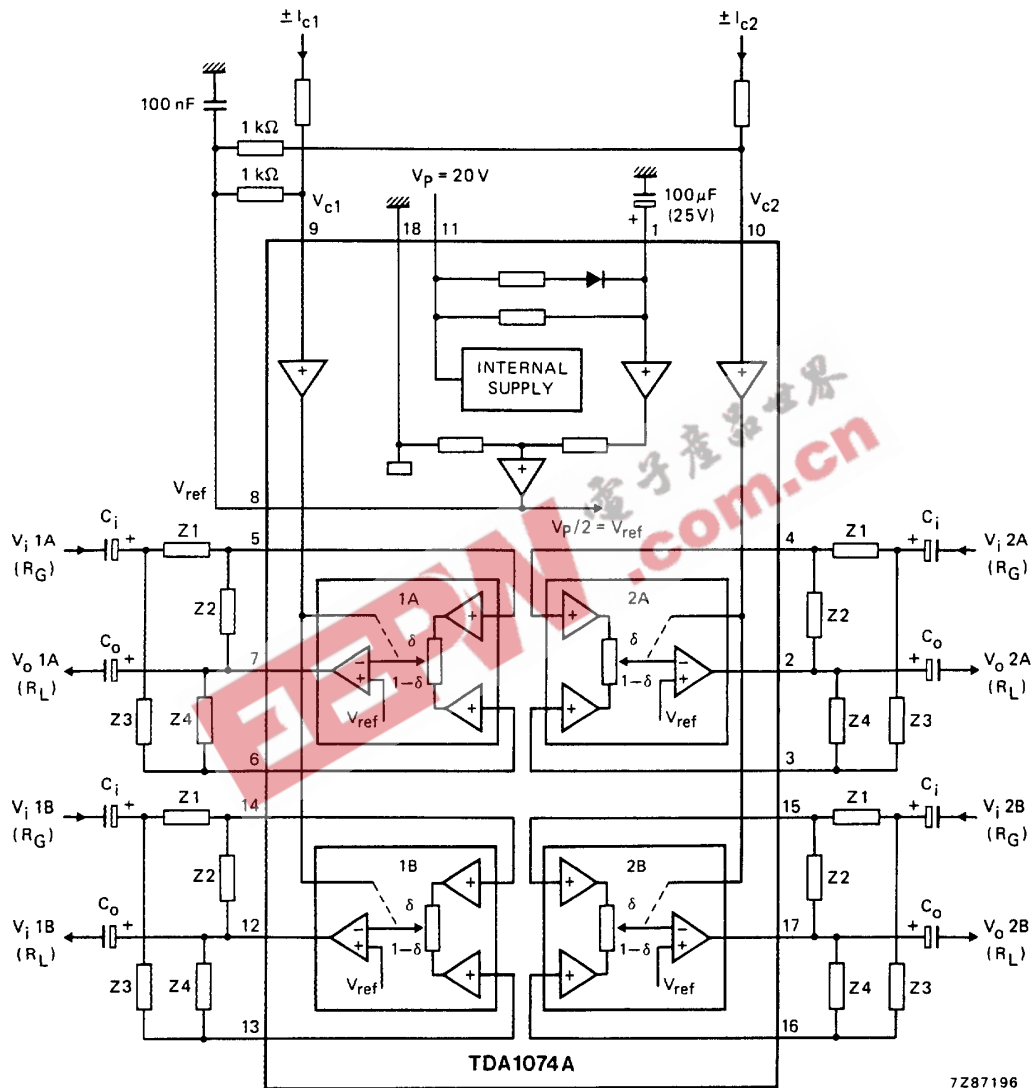

Fig.1 Block diagram and basic external components;  $I_{c1}$  (at pin 9) and  $I_{c2}$  (at pin 10) are control input currents;  $V_{c1}$  (at pin 9) and  $V_{c2}$  (at pin 10) are control input voltages with respect to  $V_{ref} = V_p/2$  at pin 8;  $Z1 = Z2 = Z3 = Z4 = 22\text{ k}\Omega$ ; the input generator resistance  $R_G = 60\ \Omega$ ; the output load resistance  $R_L = 4,7\text{ k}\Omega$ ; the coupling capacitors at the inputs and outputs are  $C_i = 2,2\ \mu F$  and  $C_o = 10\ \mu F$  respectively.

Dual tandem electronic potentiometer circuit

TDA1074A

**RATINGS**

Limiting values in accordance with the Absolute Maximum System (IEC 134)

Supply voltage (pin 11)	$V_P$	max.	23 V
Control voltages (pins 9 and 10)	$\pm V_{c1}; \pm V_{c2}$	max.	1 V
Input voltage ranges (with respect to pin 18) at pins 3, 4, 5, 6, 13, 14, 15, 16	$V_i$		0 to $V_P$ V
Total power dissipation	$P_{tot}$	max.	800 mW
Storage temperature range	$T_{stg}$		-55 to + 150 °C
Operating ambient temperature range	$T_{amb}$		-30 to + 80 °C

**THERMAL RESISTANCE**

From crystal to ambient	$R_{th\ cr-a}$	=	80 K/W
-------------------------	----------------	---	--------

**REMARK**

The difference between the TDA1074 and its successor the TDA1074A is shown in Fig.2 as the different component configuration at pin 8.

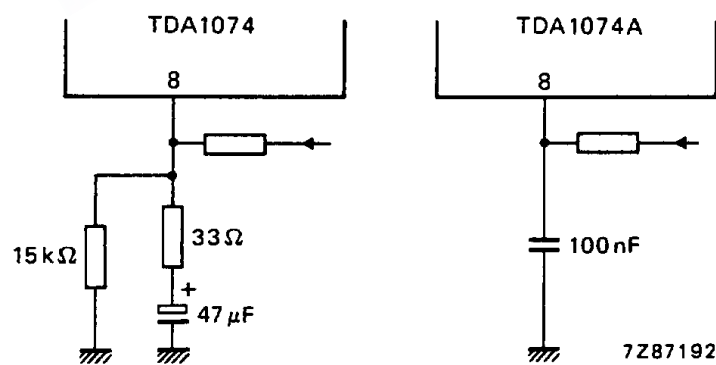

Fig.2 Component configuration at pin 8 showing the difference between the TDA1074 and the TDA1074A.

Dual tandem electronic  
potentiometer circuit

TDA1074A

## APPLICATION INFORMATION

## Treble and bass control circuit

$V_P = 20$  V;  $T_{amb} = 25$  °C; measured in Fig.3;  $R_G = 60$   $\Omega$ ;  $R_L > 4,7$  k $\Omega$ ;  $C_L < 30$  pF;  $f = 1$  kHz; with a linear frequency response ( $V_{c1} = V_{c2} = 0$  V); unless otherwise specified

PARAMETER	SYMBOL	MIN.	TYP.	MAX.	UNIT
Supply current (without load)	$I_P$	14	22	30	mA
Frequency response (-1 dB) $V_{c1} = V_{c2} = 0$ V	$f$	10	-	20 000	Hz
Voltage gain at linear frequency response ( $V_{c1} = V_{c2} = 0$ V)	$G_V^{(1)}$	-	0	-	dB
Gain variation at $f = 1$ kHz at maximum bass/treble boost or cut at $\pm V_{c1} = \pm V_{c2} = 120$ mV	$\Delta G_V^{(1)}$	-	$\pm 1$	-	dB
Bass boost at 40 Hz (ref. 1 kHz) $V_{c2} = 120$ mV		-	17,5	-	dB
Bass cut at 40 Hz (ref. 1 kHz) $-V_{c2} = 120$ mV		-	17,5	-	dB
Treble boost at 16 kHz (ref. 1 kHz) $V_{c1} = 120$ mV		-	16	-	dB
Treble cut at 16 kHz (ref. 1 kHz) $-V_{c1} = 120$ mV		-	16	-	dB
Total harmonic distortion at $V_{o(rms)} = 300$ mV $f = 1$ kHz (measured selectively)	THD	-	0,002	-	%
$f = 20$ Hz to 20 kHz at $V_{o(rms)} = 5$ V	THD	-	0,005	-	%
$f = 1$ kHz	THD	-	0,015	0,1	%
$f = 20$ Hz to 20 kHz	THD	-	0,05	0,1	%
Signal level at THD = 0,7% (input and output)	$V_{i; o(rms)}$	5,5	6,2	-	V
Power bandwidth at reference level $V_{o(rms)} = 5$ V (-3 dB); THD = 0,1%	B	-	40	-	kHz

Dual tandem electronic potentiometer circuit

TDA1074A

PARAMETER	SYMBOL	MIN.	TYP.	MAX.	UNIT
Output noise voltages signal plus noise (r.m.s. value); f = 20 Hz to 20 kHz	$V_{no(rms)}$	—	75	—	$\mu V$
noise (peak value); weighted to DIN 45 405; CCITT filter	$V_{no(m)}$	—	160	230	$\mu V$
Cross-talk attenuation (stereo) f = 1 kHz	$\alpha_{ct}$	—	86	—	dB
f = 20 Hz to 20 kHz	$\alpha_{ct}$	—	80	—	dB
Control voltage cross-talk to the outputs at f = 1 kHz; $V_{c1(rms)} = V_{c2(rms)} = 1\text{ mV}$	$-\alpha_{ct}$	—	20	—	dB
Ripple rejection at f = 100 Hz; $V_{P(rms)} < 200\text{ mV}$	$\alpha_{100}$	—	46	—	dB

Note

- $G_v = V_o / V_i$ .



# Dual tandem electronic potentiometer circuit

## TDA1074A

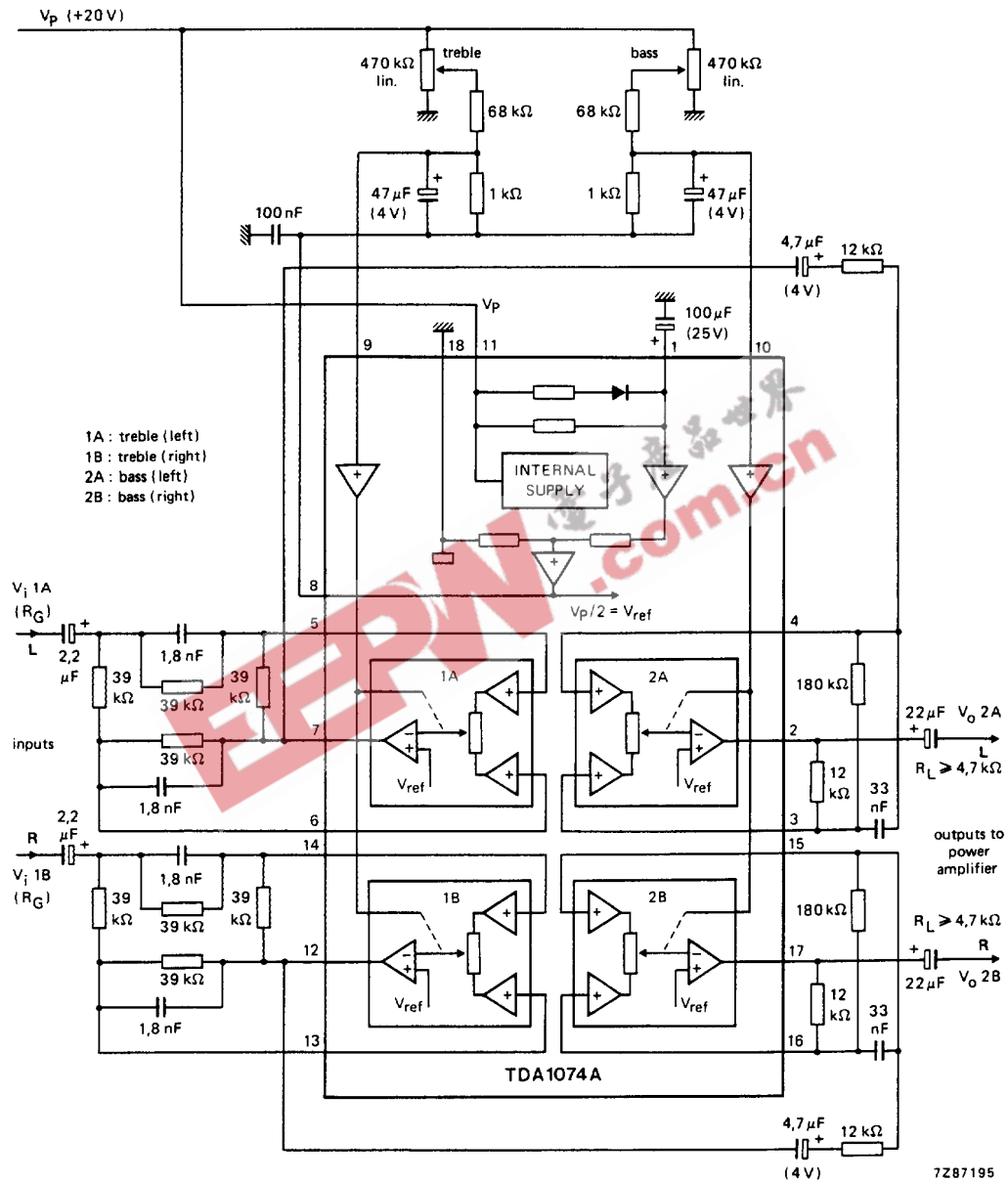

Fig.3 Application diagram for treble and bass control.

Dual tandem electronic potentiometer circuit

TDA1074A

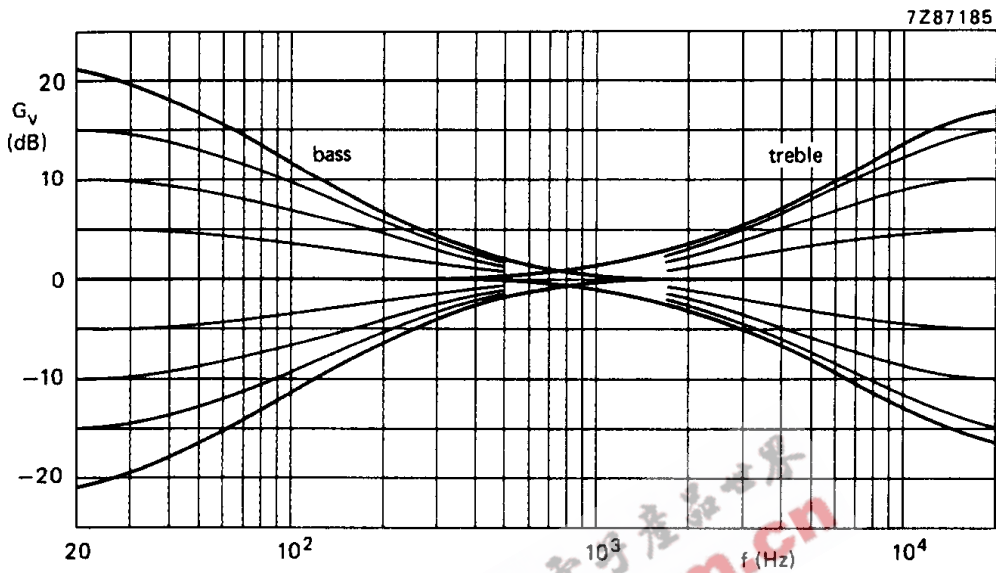

Fig.4 Frequency response curves; voltage gain (treble and bass) as a function of frequency.

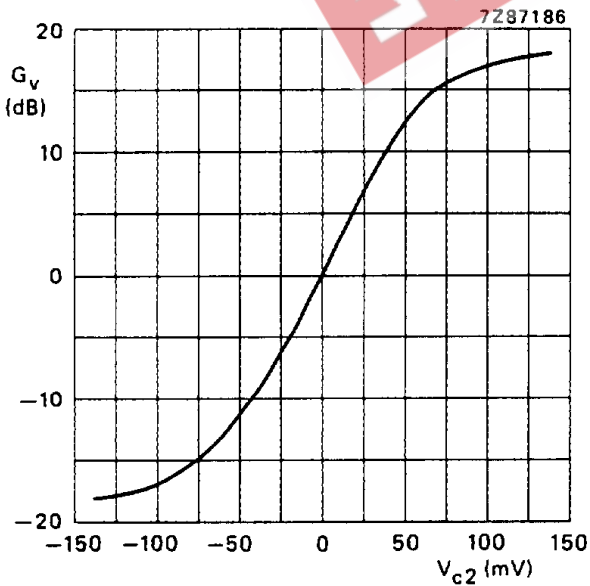

Fig.5 Control curve; voltage gain (bass) as a function of the control voltage ( $V_{c2}$ );  $f = 40$  Hz.

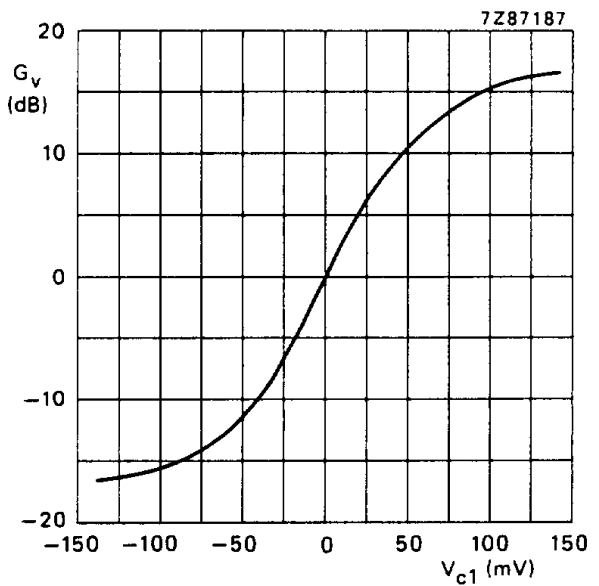
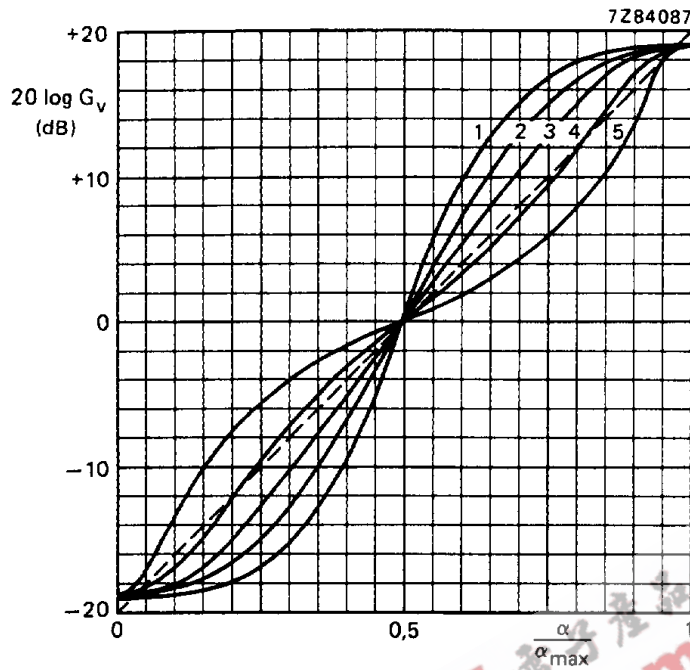

Fig.6 Control curve; voltage gain (treble) as a function of the control voltage ( $V_{c1}$ );  $f = 16$  kHz.



Dual tandem electronic potentiometer circuit

TDA1074A



curve no.	value of R
1	10 kΩ
2	100 kΩ
3	220 kΩ
4	470 kΩ
5	1 MΩ

Fig.7 Voltage gain ( $G_v = V_o / V_i$ ) control curves as a function of the angle of rotation ( $\alpha$ ) of a linear potentiometer (R); for curve numbers see table above;  $f = 40 \text{ Hz to } 16 \text{ kHz}$ .

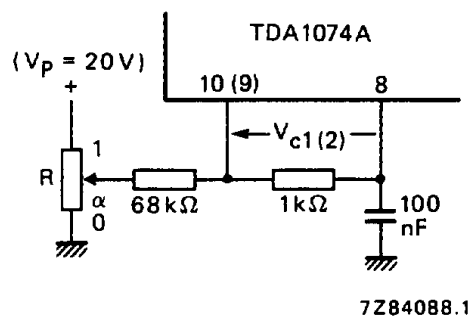

Fig.8 Circuit diagram for measuring curves in Fig.7.

Dual tandem electronic potentiometer circuit

TDA1074A

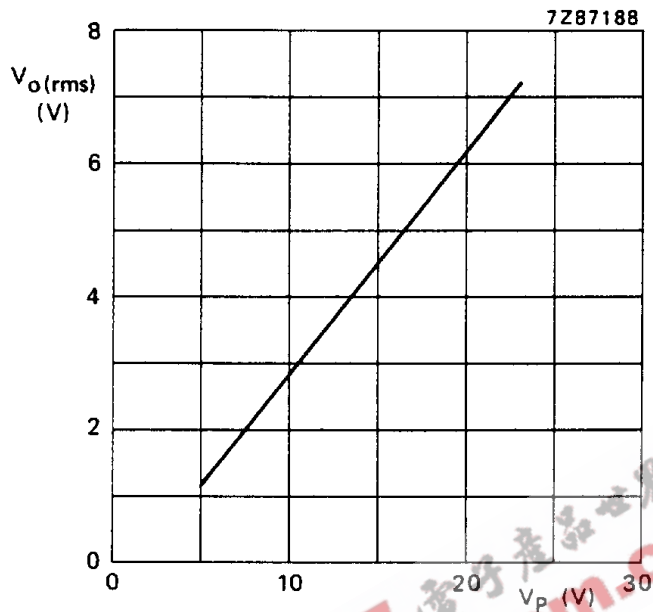

Fig.9 Output signal level as a function of  $V_p$ ; THD = 0,7%;  $f = 1$  kHz;  $V_{c1} = V_{c2} = 0$  V.

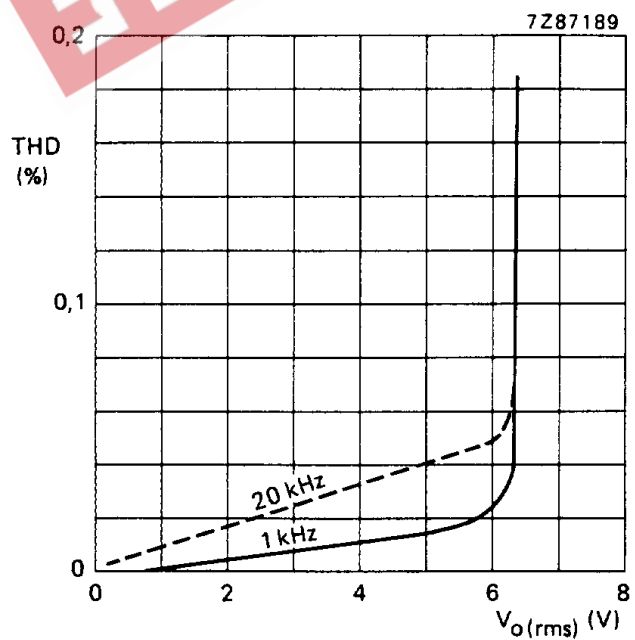

Fig.10 Total harmonic distortion as a function of the output level;  $V_p = 20$  V;  $R_L = 4,7$  k $\Omega$ ;  $V_{c1} = V_{c2} = 0$  V (linear,  $G_{v\ tot} = 1$ ). ———  $f = 1$  kHz; - - - -  $f = 20$  kHz.

Dual tandem electronic potentiometer circuit

TDA1074A

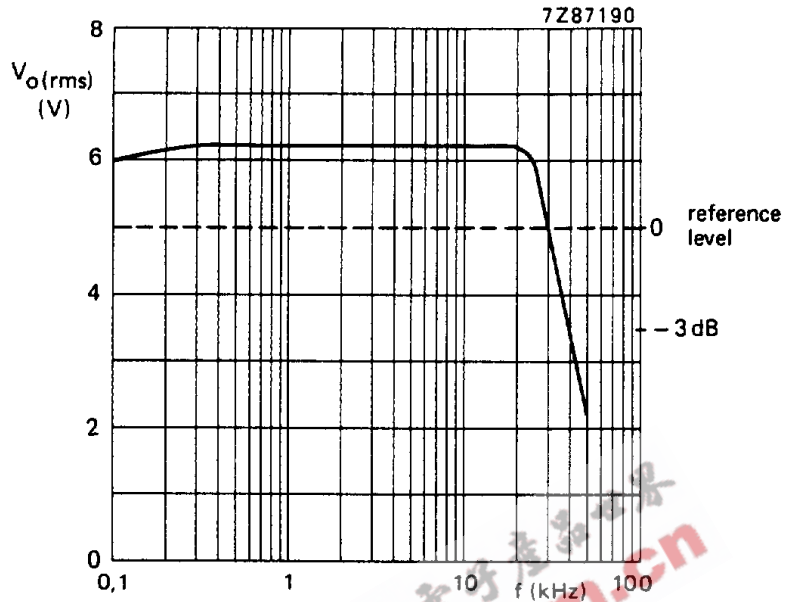

Fig.11 Power bandwidth at THD = 0,1%; reference level is 5 V (r.m.s.).

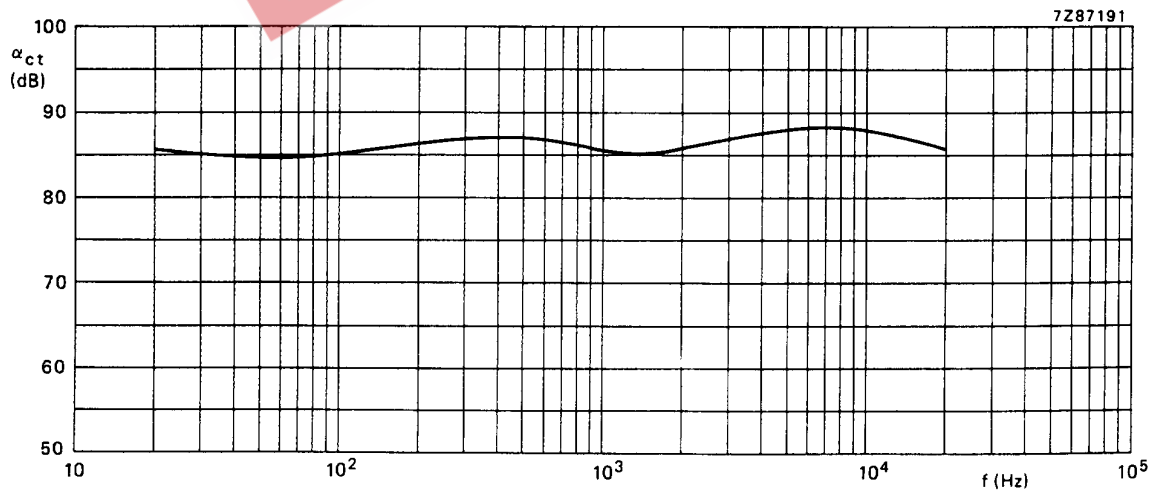

Fig.12 Cross-talk as a function of frequency; linear treble/bass setting ( $V_{c1} = V_{c2} = 0$  V);  $V_i = 5$  V;  $R_G = 60 \Omega$ ;  $R_L = 4,7$  k $\Omega$ .

Dual tandem electronic potentiometer circuit

TDA1074A

Application recommendations

1. If one or more electronic potentiometers in an IC are not used, the following is recommended:
  - a) Unused signal inputs of an electronic potentiometer should be connected to the associated output, e.g. pins 3 and 4 to pin 2.
  - b) Unused control voltage inputs should be connected directly to pin 8 ( $V_{ref}$ ).
2. Where more than one TDA1074A IC are used in an application, pins 1 can be connected together; however, pins 8 ( $V_{ref}$ ) may not be connected together directly.
3. Additional circuitry for limiting the frequency response in the ultrasonic range: see Fig.13
4. Alternative circuitry for limiting the gain of the treble control circuit in the ultrasonic range: see Fig.14

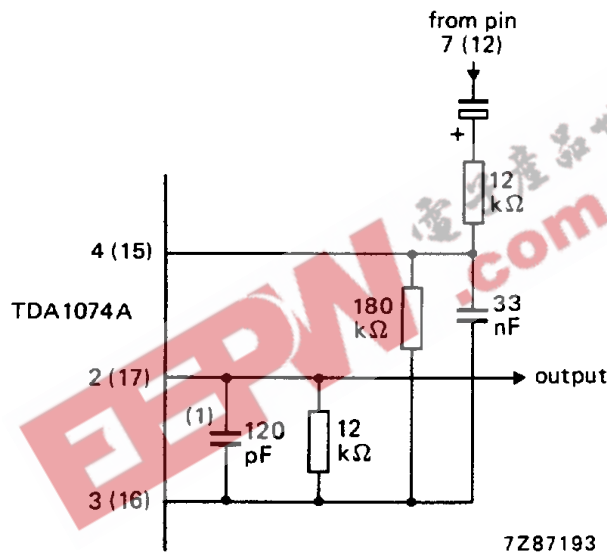

(1)  $f_{-3dB} = 110$  kHz at linear setting.

Fig.13 Circuit diagram for frequency response limiting.

Dual tandem electronic potentiometer circuit

TDA1074A

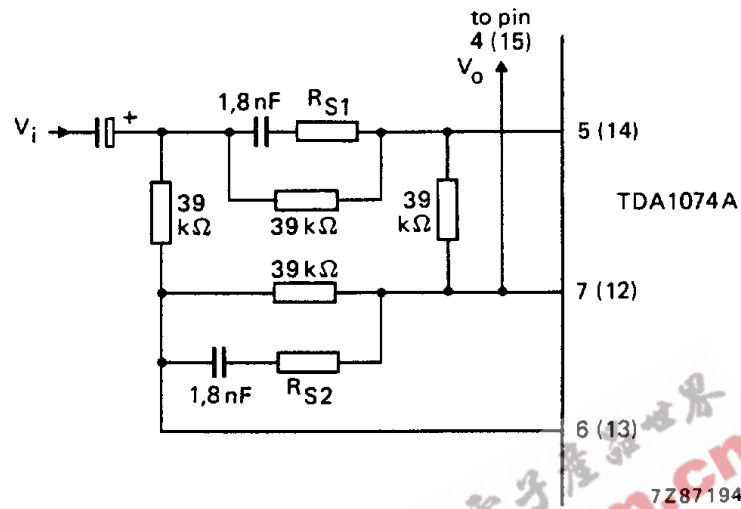

For  $R_{S1} = R_{S2} = 3,3 \text{ k}\Omega$ ;  $f_{-3 \text{ dB}} \cong 1 \text{ MHz}$  at linear setting.  
 For  $R_{S1} = R_{S2} = 0 \Omega$ ;  $f_{-3 \text{ dB}} \cong 100 \text{ kHz}$  at linear setting.

Fig.14 Circuit diagram for limiting gain of treble control circuit.

Dual tandem electronic potentiometer circuit

TDA1074A

PACKAGE OUTLINE

DIP18: plastic dual in-line package; 18 leads (300 mil)

SOT102-1

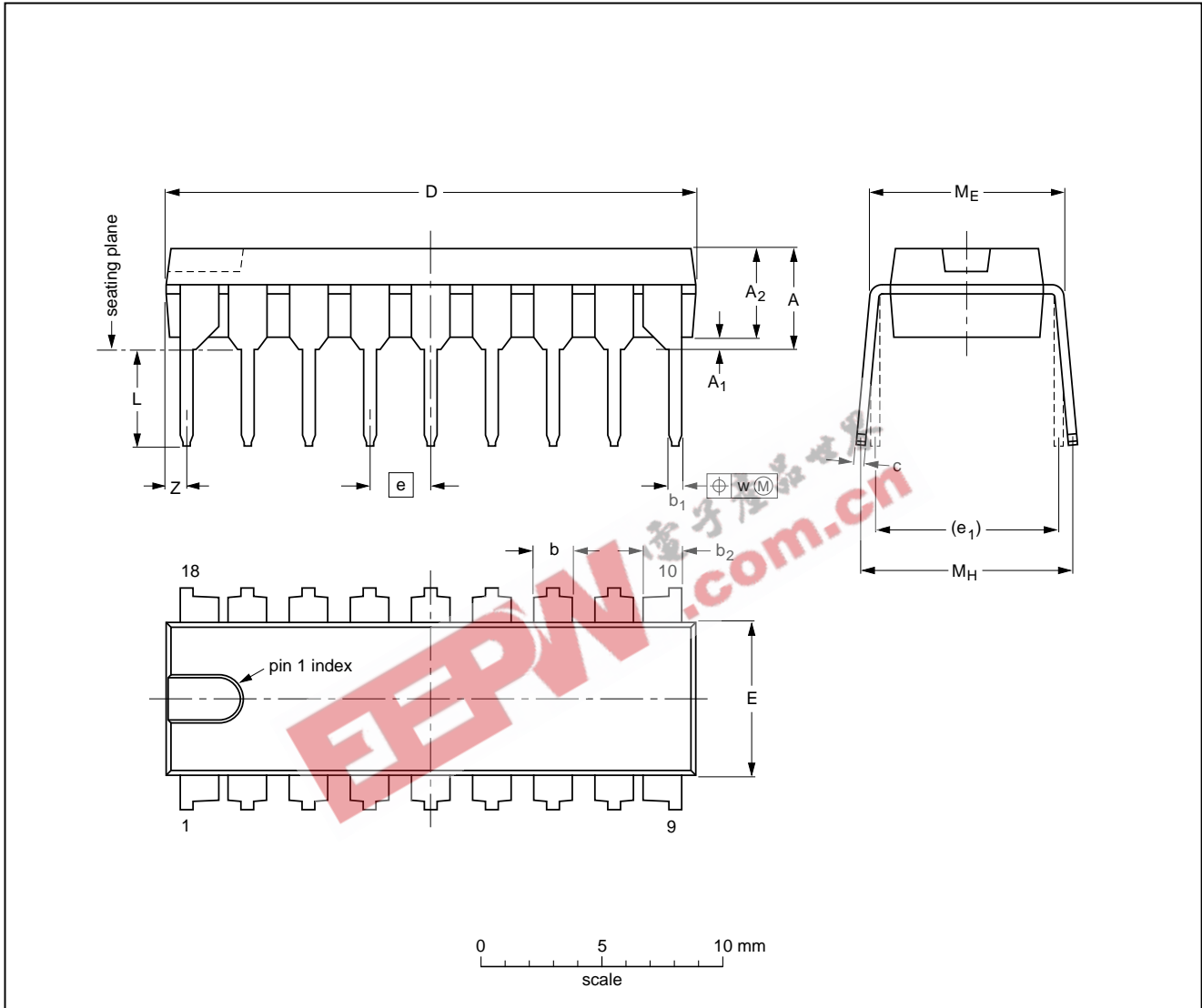

DIMENSIONS (inch dimensions are derived from the original mm dimensions)

UNIT	A max.	A <sub>1</sub> min.	A <sub>2</sub> max.	b	b <sub>1</sub>	b <sub>2</sub>	c	D <sup>(1)</sup>	E <sup>(1)</sup>	e	e <sub>1</sub>	L	M <sub>E</sub>	M <sub>H</sub>	w	Z <sup>(1)</sup> max.
mm	4.7	0.51	3.7	1.40 1.14	0.53 0.38	1.40 1.14	0.32 0.23	21.8 21.4	6.48 6.20	2.54	7.62	3.9 3.4	8.25 7.80	9.5 8.3	0.254	0.85
inches	0.19	0.020	0.15	0.055 0.044	0.021 0.015	0.055 0.044	0.013 0.009	0.86 0.84	0.26 0.24	0.10	0.30	0.15 0.13	0.32 0.31	0.37 0.33	0.01	0.033

Note

1. Plastic or metal protrusions of 0.25 mm maximum per side are not included.

OUTLINE VERSION	REFERENCES				EUROPEAN PROJECTION	ISSUE DATE
	IEC	JEDEC	EIAJ			
SOT102-1						93-10-14 95-01-23

## Dual tandem electronic potentiometer circuit

TDA1074A

### SOLDERING

#### Introduction

There is no soldering method that is ideal for all IC packages. Wave soldering is often preferred when through-hole and surface mounted components are mixed on one printed-circuit board. However, wave soldering is not always suitable for surface mounted ICs, or for printed-circuits with high population densities. In these situations reflow soldering is often used.

This text gives a very brief insight to a complex technology. A more in-depth account of soldering ICs can be found in our "IC Package Databook" (order code 9398 652 90011).

#### Soldering by dipping or by wave

The maximum permissible temperature of the solder is 260 °C; solder at this temperature must not be in contact with the joint for more than 5 seconds. The total contact time of successive solder waves must not exceed 5 seconds.

The device may be mounted up to the seating plane, but the temperature of the plastic body must not exceed the specified maximum storage temperature ( $T_{stg\ max}$ ). If the printed-circuit board has been pre-heated, forced cooling may be necessary immediately after soldering to keep the temperature within the permissible limit.

#### Repairing soldered joints

Apply a low voltage soldering iron (less than 24 V) to the lead(s) of the package, below the seating plane or not more than 2 mm above it. If the temperature of the soldering iron bit is less than 300 °C it may remain in contact for up to 10 seconds. If the bit temperature is between 300 and 400 °C, contact may be up to 5 seconds.

### DEFINITIONS

<b>Data sheet status</b>	
Objective specification	This data sheet contains target or goal specifications for product development.
Preliminary specification	This data sheet contains preliminary data; supplementary data may be published later.
Product specification	This data sheet contains final product specifications.
<b>Limiting values</b>	
Limiting values given are in accordance with the Absolute Maximum Rating System (IEC 134). Stress above one or more of the limiting values may cause permanent damage to the device. These are stress ratings only and operation of the device at these or at any other conditions above those given in the Characteristics sections of the specification is not implied. Exposure to limiting values for extended periods may affect device reliability.	
<b>Application information</b>	
Where application information is given, it is advisory and does not form part of the specification.	

### LIFE SUPPORT APPLICATIONS

These products are not designed for use in life support appliances, devices, or systems where malfunction of these products can reasonably be expected to result in personal injury. Philips customers using or selling these products for use in such applications do so at their own risk and agree to fully indemnify Philips for any damages resulting from such improper use or sale.