

DATA SHEET

TDA1551Q

2 x 22 W BTL car radio power
amplifier with diagnostic facility

EEPW 电子產品世界
.com.cn

Preliminary specification
File under Integrated Circuits, IC01

July 1994

2 x 22 W BTL car radio power amplifier with diagnostic facility

TDA1551Q

FEATURES

- Requires very few external components
- Flexible in use - quad, single ended or stereo BTL
- I²C-bus control
- Dynamic distortion detector
- Thermal protection
- Output status information
- Power supply dip detection
- High output power
- MUTE/sleep mode by writing to I²C-bus
- Stand-by mode
- Fixed gain
- Good ripple rejection
- Load dump protection
- AC/DC short circuit safe to ground and V_P
- Reverse polarity safe
- Low offset voltage at output
- Capable of handling high energy at outputs ($V_P = 0$ V)



- Electrostatic discharge protection
- No switch-ON/switch-OFF plop
- Flexible leads
- Low thermal resistance
- Identical inputs (inverting and non-inverting).

DESCRIPTION

The TDA1551Q is an integrated class-B output amplifier encased in a 17-lead single-in-line plastic power package. The device contains 4 × 11 W single-ended (SE) or 2 × 22 W BTL amplifiers and is intended for use in car radio applications.

QUICK REFERENCE DATA

SYMBOL	PARAMETER	CONDITIONS	MIN.	TYP.	MAX.	UNIT
V_P	supply voltage range	operating	6	14.4	18	V
V_P	supply voltage	non-operating	–	–	30	V
I_P	total quiescent current		–	80	160	mA
Quad-single-ended application						
P_o	output power	$R_L = 4 \Omega$; THD = 10 %	–	6	–	W
		$R_L = 2 \Omega$; THD = 10 %	–	11	–	W
V_{no}	output voltage noise	$R_S = 0 \Omega$	–	50	–	μ V
Stereo BTL application						
P_o	output power	$R_L = 4 \Omega$; THD = 10 %	–	22	–	W
V_{no}	output voltage noise	$R_S = 0 \Omega$	–	70	–	μ V
ΔV_o	DC output offset voltage		–	–	100	mV

ORDERING INFORMATION

EXTENDED TYPE NUMBER	PACKAGE			
	PINS	PIN POSITION	MATERIAL	CODE
TDA1551Q	17	SIL bent to DIL	plastic	SOT243R ⁽¹⁾

Note

1. SOT243-1; 1996 September 06.

2 x 22 W BTL car radio power amplifier
with diagnostic facility

TDA1551Q

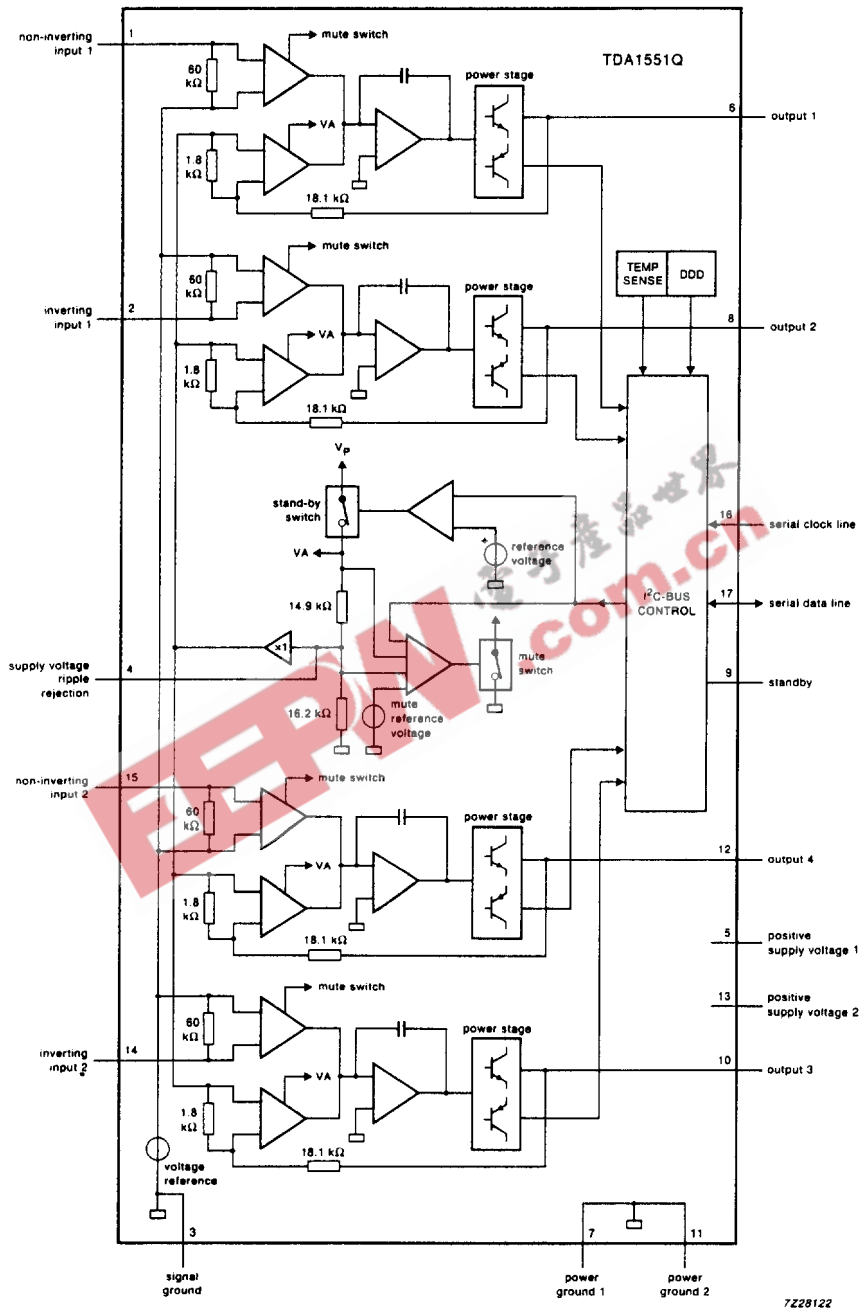

Fig.1 Block diagram.

2 x 22 W BTL car radio power amplifier with diagnostic facility

TDA1551Q

PINNING

SYMBOL	PIN	DESCRIPTION
-INV1	1	non-inverting input 1
INV1	2	inverting input 1
GND	3	signal ground
V _{PRR}	4	supply voltage ripple rejection
V _{p1}	5	positive supply voltage 1
OUT1	6	output 1
GND1	7	power ground 1
OUT2	8	output 2
SB	9	standby
OUT3	10	output 3
GND2	11	power ground 2
OUT4	12	output 4
V _{p2}	13	positive supply voltage 2
INV2	14	inverting input 2
-INV2	15	non-inverting input 2
SCL	16	serial clock line
SDA	17	serial data line

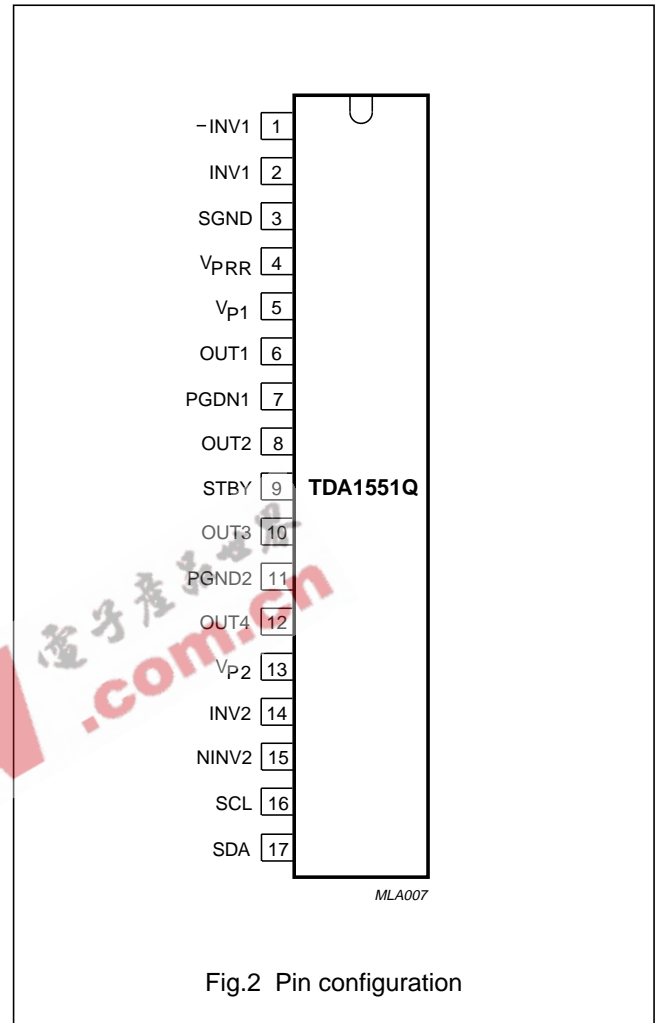

2 x 22 W BTL car radio power amplifier with diagnostic facility

TDA1551Q

FUNCTIONAL DESCRIPTION

The TDA1551Q contains four identical amplifiers with differential input stages (two inverting and two non-inverting) which can be used in SE or BTL applications. The gain of each amplifier is fixed at 20 dB for SE and 26 dB for BTL. The device also contains an I²C-bus facility which operates in the read or write mode.

In the **write** mode the device can be switched to either the sleep condition (low sleep current of 0.6 mA typ.), the MUTE condition or the ON condition.

In the **read** mode an 8-bit status word is available. Data bits D0 to D3 contain status information of each of the 4 outputs. If the device is switched to the ON or MUTE condition and there is a short-circuit at one or more outputs, the power transistors will be outside their safe operating area consequently one or more bits of D0 to D3 will be HIGH. Bits D0 to D3 are LOW when in the normal safe operating area. Bit D4 is normally LOW if one or more channels reaches the clipping level D4 will go HIGH. Bit D5 is normally LOW, if the crystal temperature reaches 150 °C D5 will go HIGH. After a power-on reset bit 7 will go HIGH and a dip in the power supply will be noticed. Bit 7 will go LOW after the I²C-bus is read. When pin 9 is LOW the device will switch OFF and the supply current will be reduced to 0.1 mA (max.).

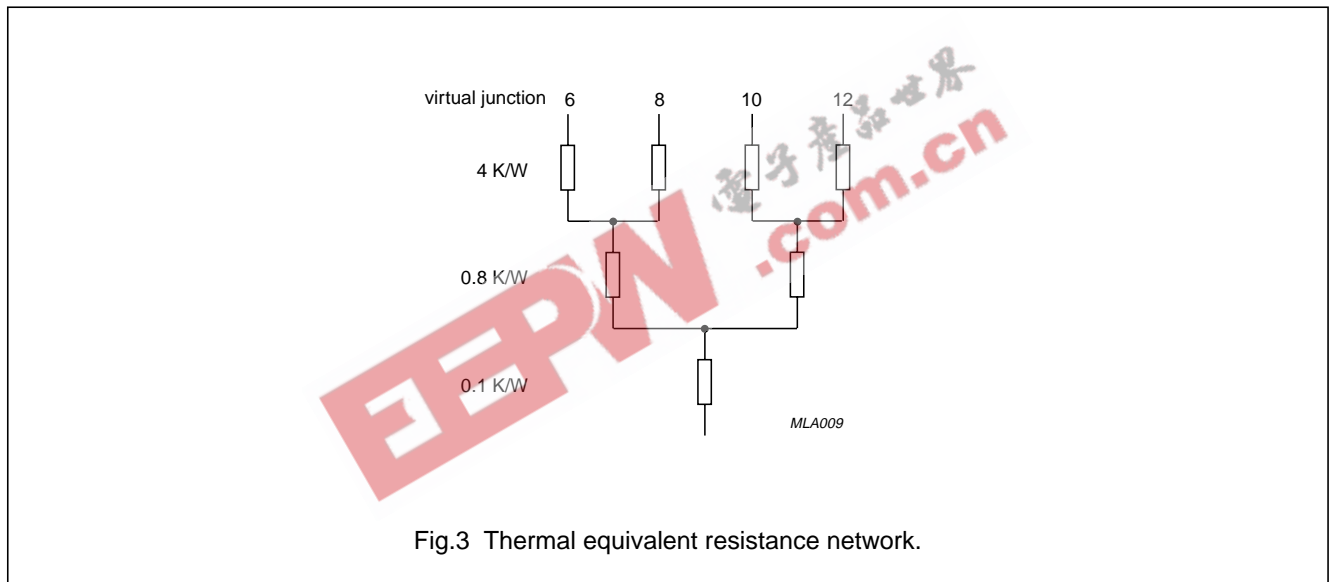

2 x 22 W BTL car radio power amplifier with diagnostic facility

TDA1551Q

LIMITING VALUES

In accordance with the Absolute Maximum System (IEC134)

SYMBOL	PARAMETER	MIN.	MAX.	UNIT
Supply voltage				
V_P	operating voltage	–	18	V
V_P	non-operating voltage	–	30	V
	load dump protect	–	45	V
IOSM	non-repetitive peak output current	–	6	A
IORM	repetitive peak output current	–	4	A
T_{stg}	storage temperature range	–55	150	°C
T_C	crystal temperature	–	150	°C
V_{Psc}	AC/DC short-circuit safe voltage	–	18	V
	energy handling capability at outputs ($V_P = 0$)	–	200	mJ
V_{Pr}	reverse polarity	–	6	V
P_{tot}	total power dissipation	–	60	W

QUALITY SPECIFICATION

Electrostatic handling.

SYMBOL	PINS	MIN.	MAX.	UNIT
Human body model; $R_S = 1500 \Omega$; $C = 100 \text{ pF}$				
V_{es}	1, 2, 14, 15, 16, and 17	–1.5	+1.5	kV
	other	–2	+2	kV
Machine model; $R_S = 0 \Omega$; $C = 200 \text{ pF}$				
V_{es}	1, 2, 14, 15, 16, and 17	–100	+100	V
	other	–200	+200	V

THERMAL RESISTANCE

SYMBOL	PARAMETER	THERMAL RESISTANCE
$R_{th j-c}$	from junction to case (Fig.3)	1.5 K/W
$R_{th j-a}$	from junction to ambient in free air	40 K/W

2 x 22 W BTL car radio power amplifier with diagnostic facility

TDA1551Q

DC CHARACTERISTICS

$V_P = 14.4\text{ V}$; $T_{\text{amb}} = 25^\circ\text{C}$ measurements in accordance with Fig.6 unless otherwise stated.

SYMBOL	PARAMETER	CONDITIONS	MIN.	TYP.	MAX.	UNIT
Supply						
V_P	supply voltage	note 1	6	14.4	18	V
I_P	quiescent current		–	80	160	mA
V_O	DC output voltage	note 2	–	6.9	–	V
$ \Delta V_O $	DC output offset voltage		–	–	100	mV
MUTE/sleep/standby						
V_O	output signal in MUTE position	$V_{I(\text{max})} = 1\text{ V}$; $f = 20\text{ Hz to } 10\text{ kHz}$	–	–	2	mV
I_P	DC current in sleep condition	$V_9 > 3\text{ V}$	–	0.6	1	mA
I_P	DC current in standby condition	$V_9 < 2\text{ V}$	–	–	0.1	mA
$ \Delta V_O $	DC output offset voltage		–	–	100	mV

EEPW 电子产品世界
.com.cn

2 x 22 W BTL car radio power amplifier with diagnostic facility

TDA1551Q

AC CHARACTERISTICS

$V_P = 14.4\text{ V}$; $T_{\text{amb}} = 25^\circ\text{C}$; $f = 1\text{ kHz}$; $R_L = 4\ \Omega$; unless otherwise specified.

SYMBOL	PARAMETER	CONDITIONS	MIN.	TYP.	MAX.	UNIT
Stereo BTL application (Fig.7)						
P_O	output power	THD = 0.5%	15	17	-	W
			20	22	-	W
P_O	output power	$V_P = 13.2\text{V}$	-	12	-	W
		THD = 0.5%	-	17	-	W
		THD = 10%	-	-	-	-
THD	total harmonic distortion	$P_O = 1\text{ W}$	-	0.05	-	%
B	power bandwidth	THD = 0.5%; $P_O = -1\text{ dB}$ with respect to 15 W	-	20 - 15000	-	Hz
f_{LOW}	low frequency roll-off	at -3 dB; note 3	-	25	-	Hz
f_{HIGH}	high frequency roll-off	at -1 dB	20	-	-	kHz
G_V	closed loop voltage gain		25	26	27	dB
V_{PRR}	supply voltage ripple rejection	ON; note 4	48	-	-	dB
		MUTE; note 4	48	-	-	dB
		standby; note 4	80	-	-	dB
$ Z_i $	input impedance		25	30	38	k Ω
V_{no}	noise output voltage	ON; $R_S = 0$; note 5	-	70	-	μV
		ON; $R_S = 10\text{ k}\Omega$; note 5	-	100	200	μV
		MUTE; notes 5 and 6	-	60	-	μV
α	channel separation	$R_S = 10\text{ k}\Omega$	40	-	-	dB
$ \Delta G_V $	channel unbalance		-	-	1	dB
	dynamic distortion detector switch level		-	3.5	-	%
Quad single-ended application (Fig.6)						
P_O	output power	THD = 0.5%; note 7	4	5	-	W
		THD = 10%; note 7	5.5	6	-	W
P_O	output power	$R_L = 2\ \Omega$				
		THD = 0.5%; note 7	7.5	8.5	-	W
		THD = 10%; note 7	10	11	-	W
THD	total harmonic distortion	$P_O = 1\text{ W}$	-	0.05	-	%
f_{LOW}	low frequency roll-off	at -3 dB; note 3	-	25	-	Hz
f_{HIGH}	high frequency roll-off	at -1 dB	20	-	-	kHz
G_V	closed loop voltage gain		19	20	21	dB
V_{PRR}	supply voltage ripple rejection	ON; note 4	48	-	-	dB
		MUTE; note 4	48	-	-	dB
		stand-by; note 4	80	-	-	dB
$ Z_i $	input impedance		50	60	75	k Ω
V_{no}	noise output voltage	ON; $R_S = 0$; note 5	-	50	-	μV
		ON; $R_S = 10\text{ k}\Omega$; note 5	-	70	100	μV

2 x 22 W BTL car radio power amplifier with diagnostic facility

TDA1551Q

SYMBOL	PARAMETER	CONDITIONS	MIN.	TYP.	MAX.	UNIT
		MUTE; notes 5 and 6	–	60	–	μV
α	channel separation	$R_S = 10 \text{ k}\Omega$	40	–	–	dB
$ \Delta G_V $	channel unbalance		–	–	1	dB
	dynamic distortion detector switch level		–	3.5	–	%
I²C-bus (see I²C-bus protocol)						
V_{IH}	input voltage HIGH		3	–	5.5	V
V_{IL}	input voltage LOW		–0.3	–	1.5	V
I_{IH}	input current HIGH	$V = 5.5 \text{ V}$	–10	–	10	μA
I_{IL}	input current LOW	$V = \text{GND}$	–10	–	10	μA
V_{OL}	output voltage LOW	$I_L = 3 \text{ mA}$	–	–	0.4	V
Power-on reset (increasing supply voltage)						
V_P	start of reset		0.5	–	–	V
	end of reset		–	–	5	V
Standby (pin 9)						
V_9	input voltage HIGH		3	–	V_P	V
	input voltage LOW		–	–	2	V

Notes to the characteristics

1. The circuit is DC adjusted at $V_P = 6 \text{ V}$ and AC operating at $V_P = 8 \text{ to } 18 \text{ V}$.
2. At $18 \text{ V} < V_P < 30 \text{ V}$ the DC output voltage $< V_P/2$.
3. Frequency response externally fixed.
4. Ripple rejection measured at the output with a source impedance of 0Ω and at frequency of 100 Hz to 10 kHz (amplitude = 2 V(p-p)).
5. Noise voltage measured in a bandwidth of 20 Hz to 20 kHz.
6. Noise output voltage independent of R_S ($V_I = 0 \text{ V}$).
7. Output power is measured directly at the output pins of the IC.

2 x 22 W BTL car radio power amplifier with diagnostic facility

TDA1551Q

Table 2 READ definition ($\overline{R/W}$ = HIGH)

D7 ⁽¹⁾⁽²⁾	D6	D5 ⁽³⁾⁽⁴⁾	D4 ⁽⁵⁾⁽⁶⁾	D3 ⁽⁷⁾	D2 ⁽⁷⁾	D2 ⁽⁷⁾	D0 ⁽⁷⁾
-----------------------------	-----------	-----------------------------	-----------------------------	--------------------------	--------------------------	--------------------------	--------------------------

Notes

1. LOW after reading I²C-bus.
2. HIGH after power-on reset.
3. LOW if crystal temperature < 150°C.
4. HIGH if crystal temperature reaches 150°C.
5. LOW if not clipping.
6. HIGH if one or more channels are clipping.
7. output status information.

If the device is sinewave driven bit D4 will be HIGH if the THD in one or more channels exceeds 3.5%.

Table 3 Fault conditions

DATA		MSB		FUNCTION
D3	D2	D1	D0	
0	0	0	0	all output power transistors in the normal safe operating condition
–	–	–	1	fault condition pin 6
–	–	1	–	fault condition pin 8
–	1	–	–	fault condition pin 10
1	–	–	–	fault condition pin 12

If more outputs are in a fault condition (e.g. short-circuit) then more bits, D3 to D0, will be HIGH.

2 x 22 W BTL car radio power amplifier
with diagnostic facility

TDA1551Q

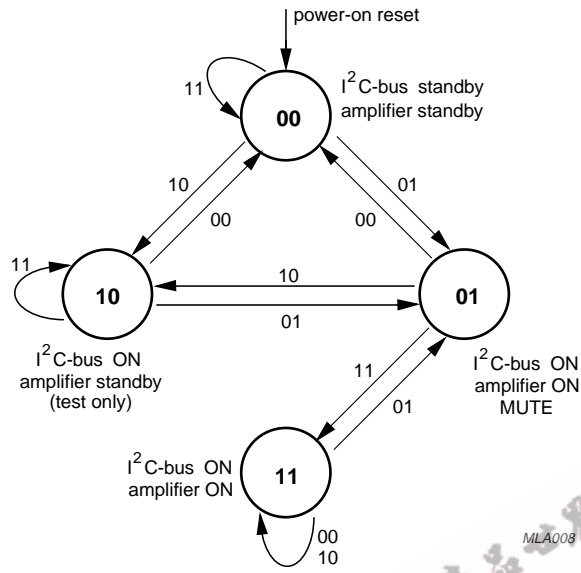
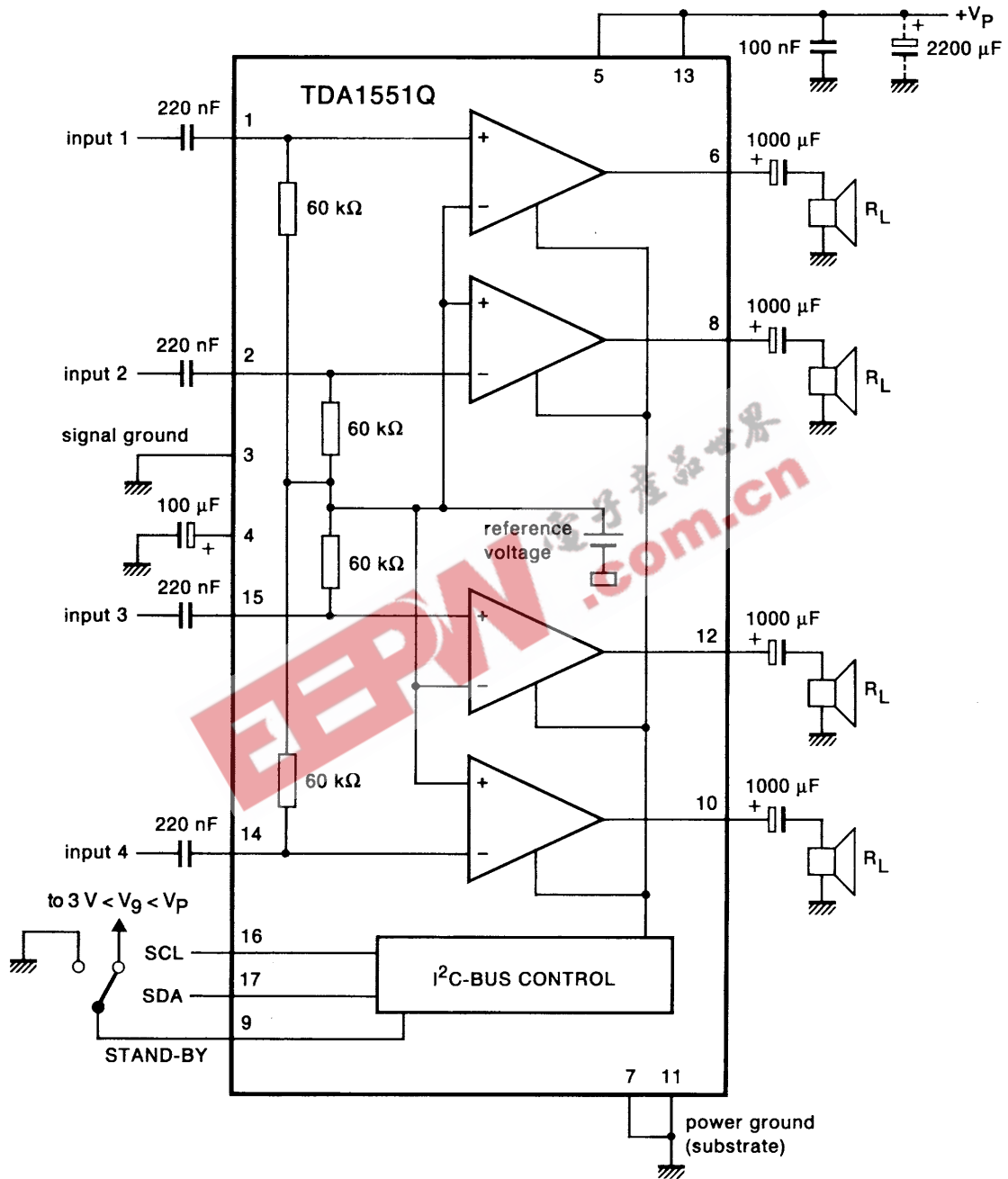

Fig.5 State diagram.

2 x 22 W BTL car radio power amplifier
with diagnostic facility

TDA1551Q



7Z28121

Fig.6 Test circuit quad single-ended.

2 x 22 W BTL car radio power amplifier
with diagnostic facility

TDA1551Q

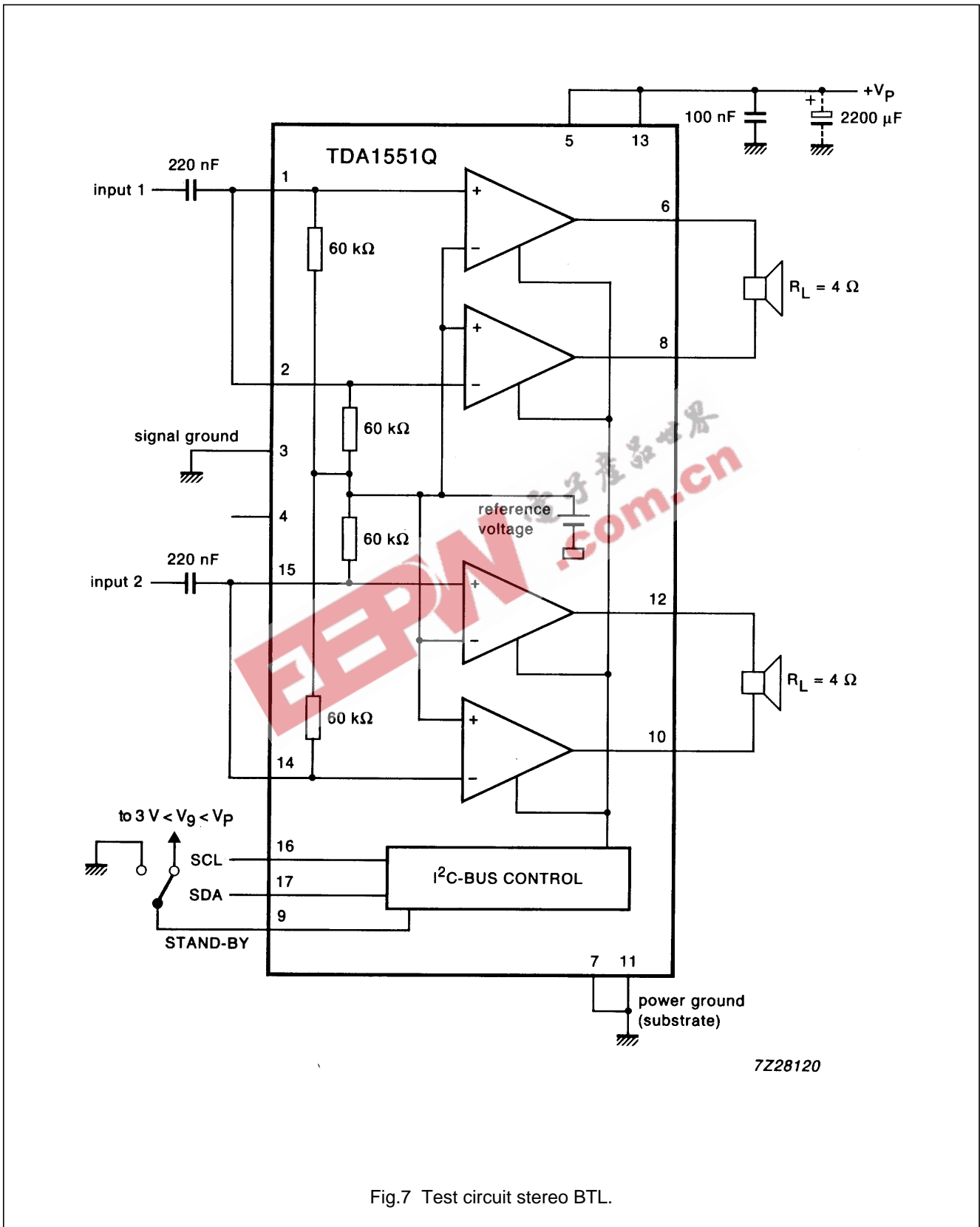

7Z28120

Fig.7 Test circuit stereo BTL.

2 x 22 W BTL car radio power amplifier
with diagnostic facility

TDA1551Q

PACKAGE OUTLINE

DBS17P: plastic DIL-bent-SIL power package; 17 leads (lead length 12 mm)

SOT243-1

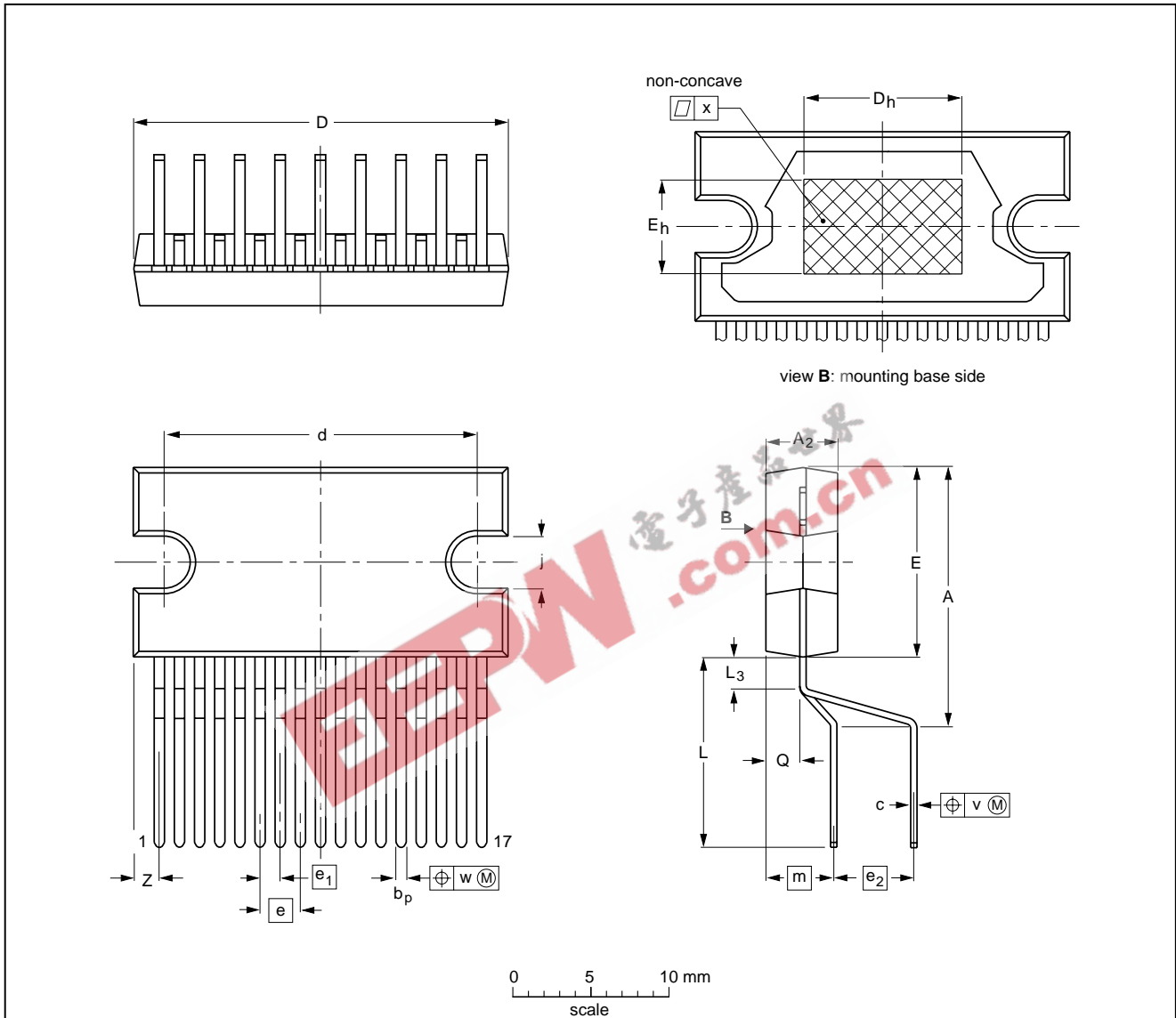

DIMENSIONS (mm are the original dimensions)

UNIT	A	A ₂	b _p	c	D ⁽¹⁾	d	D _h	E ⁽¹⁾	e	e ₁	e ₂	E _h	j	L	L ₃	m	Q	v	w	x	Z ⁽¹⁾
mm	17.0 15.5	4.6 4.2	0.75 0.60	0.48 0.38	24.0 23.6	20.0 19.6	10	12.2 11.8	2.54	1.27	5.08	6	3.4 3.1	12.4 11.0	2.4 1.6	4.3	2.1 1.8	0.8	0.4	0.03	2.00 1.45

Note

1. Plastic or metal protrusions of 0.25 mm maximum per side are not included.

OUTLINE VERSION	REFERENCES				EUROPEAN PROJECTION	ISSUE DATE
	IEC	JEDEC	EIAJ			
SOT243-1						95-03-11 97-12-16

**2 x 22 W BTL car radio power amplifier
with diagnostic facility**

TDA1551Q**SOLDERING****Introduction**

There is no soldering method that is ideal for all IC packages. Wave soldering is often preferred when through-hole and surface mounted components are mixed on one printed-circuit board. However, wave soldering is not always suitable for surface mounted ICs, or for printed-circuits with high population densities. In these situations reflow soldering is often used.

This text gives a very brief insight to a complex technology. A more in-depth account of soldering ICs can be found in our "IC Package Databook" (order code 9398 652 90011).

Soldering by dipping or by wave

The maximum permissible temperature of the solder is 260 °C; solder at this temperature must not be in contact with the joint for more than 5 seconds. The total contact time of successive solder waves must not exceed 5 seconds.

The device may be mounted up to the seating plane, but the temperature of the plastic body must not exceed the specified maximum storage temperature ($T_{stg\ max}$). If the printed-circuit board has been pre-heated, forced cooling may be necessary immediately after soldering to keep the temperature within the permissible limit.

Repairing soldered joints

Apply a low voltage soldering iron (less than 24 V) to the lead(s) of the package, below the seating plane or not more than 2 mm above it. If the temperature of the soldering iron bit is less than 300 °C it may remain in contact for up to 10 seconds. If the bit temperature is between 300 and 400 °C, contact may be up to 5 seconds.

EEPW 电子产品世界
.com.cn

2 x 22 W BTL car radio power amplifier with diagnostic facility

TDA1551Q

DEFINITIONS

Data sheet status	
Objective specification	This data sheet contains target or goal specifications for product development.
Preliminary specification	This data sheet contains preliminary data; supplementary data may be published later.
Product specification	This data sheet contains final product specifications.
Limiting values	
Limiting values given are in accordance with the Absolute Maximum Rating System (IEC 134). Stress above one or more of the limiting values may cause permanent damage to the device. These are stress ratings only and operation of the device at these or at any other conditions above those given in the Characteristics sections of the specification is not implied. Exposure to limiting values for extended periods may affect device reliability.	
Application information	
Where application information is given, it is advisory and does not form part of the specification.	

LIFE SUPPORT APPLICATIONS

These products are not designed for use in life support appliances, devices, or systems where malfunction of these products can reasonably be expected to result in personal injury. Philips customers using or selling these products for use in such applications do so at their own risk and agree to fully indemnify Philips for any damages resulting from such improper use or sale.

PURCHASE OF PHILIPS I²C COMPONENTS



Purchase of Philips I²C components conveys a license under the Philips' I²C patent to use the components in the I²C system provided the system conforms to the I²C specification defined by Philips. This specification can be ordered using the code 9398 393 40011.