

TL2217-285 FIXED-VOLTAGE REGULATORS FOR SCSI ACTIVE TERMINATION

SLVS066F – NOVEMBER 1991 – REVISED JULY 1999

- Fully Matches Parameters for SCSI Alternative 2 Active Termination
- Fixed 2.85-V Output
- $\pm 1.5\%$ Maximum Output Tolerance at $T_J = 25^\circ\text{C}$
- 1-V Maximum Dropout Voltage
- 500-mA Output Current
- $\pm 3\%$ Absolute Output Variation
- Internal Overcurrent-Limiting Circuitry
- Internal Thermal-Overload Protection
- Internal Overvoltage Protection

description

The TL2217-285 is a low-dropout (1 V) fixed-voltage regulator specifically designed for small computer systems interface (SCSI) alternative 2 active signal termination. The TL2217-285 1-V maximum dropout ensures compatibility with existing SCSI systems, while providing a wide TERMPWR voltage range. At the same time, the $\pm 1.5\%$ initial tolerance on its 2.85-V output voltage ensures a tighter line-driver current tolerance, thereby increasing system noise margin.

The fixed 2.85-V output voltage of TL2217-285 supports the SCSI alternative 2 termination standard, while reducing system power consumption. The 1-V maximum dropout voltage brings increased TERMPWR isolation, making the device ideal for battery-powered systems. The TL2217-285, with internal current limiting, overvoltage protection, ESD protection, and thermal protection, offers designers enhanced system protection and reliability.

When configured as a SCSI active terminator, the TL2217-285 low-dropout regulator eliminates the 220- Ω and 330- Ω resistors required for each transmission line with a passive termination scheme, reducing significantly the continuous system-power drain. When placed in series with 110- Ω resistors, the device matches the impedance level of the transmission cable and eliminates reflections.

The TL2217-285 is characterized for operation over the virtual junction temperature range of 0°C to 125°C .

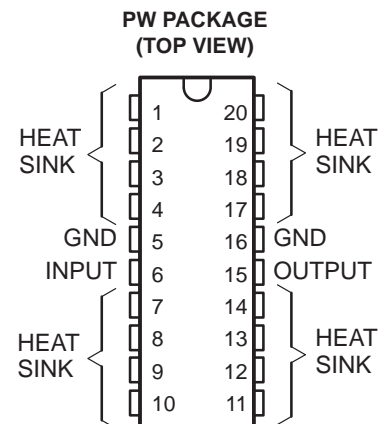

HEAT SINK – These pins have an internal resistive connection to ground and should be grounded or electrically isolated.

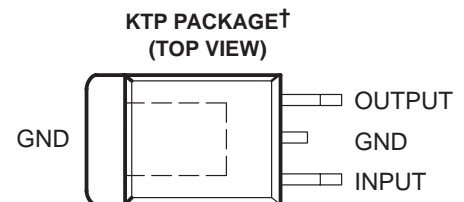
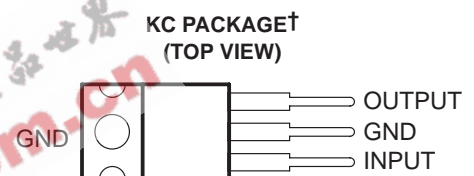

† The GND terminal is in electrical contact with the mounting base.



Please be aware that an important notice concerning availability, standard warranty, and use in critical applications of Texas Instruments semiconductor products and disclaimers thereto appears at the end of this data sheet.

PRODUCTION DATA information is current as of publication date. Products conform to specifications per the terms of Texas Instruments standard warranty. Production processing does not necessarily include testing of all parameters.

**TEXAS
INSTRUMENTS**

POST OFFICE BOX 655303 • DALLAS, TEXAS 75265

Copyright © 1999, Texas Instruments Incorporated

TL2217-285 FIXED-VOLTAGE REGULATORS FOR SCSI ACTIVE TERMINATION

SLVS066F – NOVEMBER 1991 – REVISED JULY 1999

AVAILABLE OPTIONS

T _J	PACKAGED DEVICES			CHIP FORM (Y)
	PLASTIC POWER (KC)	PLASTIC FLANGE MOUNT (KTP)	SURFACE MOUNT (PW)	
0°C to 125°C	TL2217-285KC	TL2217-285KTP	TL2217-285PWR	TL2217-285Y

The KTP and PW packages are only available taped and reeled. Add the suffix R to the device type (e.g., TL2217-285KTPR). Chip forms are tested at 25°C.

absolute maximum ratings over operating virtual junction temperature range (unless otherwise noted)†

Continuous input voltage, V _I	7.5 V
Operating virtual junction temperature range, T _J	–55°C to 150°C
Package thermal impedance, θ _{JA} (see Notes 1 and 2):	
KC package	22°C/W
KTP package	28°C/W
PW package	83°C/W
Lead temperature 1,6 mm (1/16 inch) from case for 60 seconds	260°C
Storage temperature range, T _{stg}	–65°C to 150°C

† Stresses beyond those listed under “absolute maximum ratings” may cause permanent damage to the device. These are stress ratings only, and functional operation of the device at these or any other conditions beyond those indicated under “recommended operating conditions” is not implied. Exposure to absolute-maximum-rated conditions for extended periods may affect device reliability.

NOTES: 1. Maximum power dissipation is a function of T_{J(max)}, θ_{JA}, and T_A. The maximum allowable power dissipation at any allowable ambient temperature is P_D = (T_{J(max)} – T_A)/θ_{JA}. Operating at the absolute maximum T_J of 150°C can impact reliability. Due to variations in individual device electrical characteristics and thermal resistance, the built-in thermal overload protection may be activated at power levels slightly above or below the rated dissipation.

2. The package thermal impedance is calculated in accordance with JEDEC 51, except for through-hole packages, which use a trace length of zero.

recommended operating conditions

	MIN	MAX	UNIT
Input voltage, V _I	3.85	5.5	V
Output current, I _O	0	500	mA
Operating virtual junction temperature range, T _J	TL2217-285		°C

TL2217-285
FIXED-VOLTAGE REGULATORS
FOR SCSI ACTIVE TERMINATION
 SLVS066F – NOVEMBER 1991 – REVISED JULY 1999

electrical characteristics over recommended operating conditions, $V_I = 4.5\text{ V}$, $I_O = 500\text{ mA}$, $T_J = 25^\circ\text{C}$ (unless otherwise noted)

PARAMETER	TEST CONDITION [†]	TL2217-285			UNIT	
		MIN	TYP	MAX		
Output voltage	$I_O = 20\text{ mA to }500\text{ mA}$, $V_I = 3.85\text{ V to }5.5\text{ V}$	$T_J = 25^\circ\text{C}$	2.81	2.85	2.89	V
		$T_J = 0^\circ\text{C to }125^\circ\text{C}$	2.765		2.935	
Input voltage regulation	$V_I = 3.85\text{ V to }5.5\text{ V}$		5	15	mV	
Ripple rejection	$f = 120\text{ Hz}$, $V_{\text{ripple}} = 1\text{ V}_{\text{PP}}$		-62		dB	
Output voltage regulation	$I_O = 20\text{ mA to }500\text{ mA}$		5	30	mV	
Output noise voltage	$f = 10\text{ Hz to }100\text{ kHz}$		500		μV	
Dropout voltage				1	V	
Bias current	$I_O = 0$		2	5	mA	
	$I_O = 27\text{ mA}$, equivalent 1 line asserted		3	6		
	$I_O = 500\text{ mA}$, equivalent 18 lines asserted (8 bit)		26	49		

[†] Pulse-testing techniques are used to maintain the virtual junction temperature as close to the ambient temperature as possible. Thermal effects must be taken into account separately. All characteristics are measured with a 0.1- μF capacitor across the input and a 22- μF tantalum capacitor with equivalent series resistance of 1.5 Ω on the output.

electrical characteristics over recommended operating conditions, $V_I = 4.5\text{ V}$, $I_O = 500\text{ mA}$, $T_J = 25^\circ\text{C}$ (unless otherwise noted)

PARAMETER	TEST CONDITION [†]	TL2217-285Y			UNIT
		MIN	TYP	MAX	
Output voltage	$I_O = 20\text{ mA to }500\text{ mA}$, $V_I = 3.85\text{ V to }5.5\text{ V}$	2.81	2.85	2.89	V
Input voltage regulation	$V_I = 3.85\text{ V to }5.5\text{ V}$		5	15	mV
Ripple rejection	$f = 120\text{ Hz}$, $V_{\text{ripple}} = 1\text{ V}_{\text{PP}}$		-62		dB
Output voltage regulation	$I_O = 20\text{ mA to }500\text{ mA}$		5	30	mV
Output noise voltage	$f = 10\text{ Hz to }100\text{ kHz}$		500		μV
Dropout voltage	$I_O = 500\text{ mA}$			1	V
Bias current	$I_O = 0$		2	5	mA
	$I_O = 27\text{ mA}$, equivalent 1 line asserted		3	6	
	$I_O = 500\text{ mA}$, equivalent 18 lines asserted (8 bit)		26	49	

[†] Pulse-testing techniques are used to maintain the virtual junction temperature as close to the ambient temperature as possible. Thermal effects must be taken into account separately. All characteristics are measured with a 0.1- μF capacitor across the input and a 22- μF tantalum capacitor with equivalent series resistance of 1.5 Ω on the output.

TL2217-285
FIXED-VOLTAGE REGULATORS
FOR SCSI ACTIVE TERMINATION
 SLVS066F – NOVEMBER 1991 – REVISED JULY 1999

COMPENSATION-CAPACITOR SELECTION INFORMATION

The TL2217-285 is a low-dropout regulator. This means that the capacitance loading is important to the performance of the regulator because it is a vital part of the control loop. The capacitor value and the equivalent series resistance (ESR) both affect the control loop and must be defined for the load range and the temperature range. Figure 3 and Figure 4 can be used to establish the capacitance value and ESR range for best regulator performance.

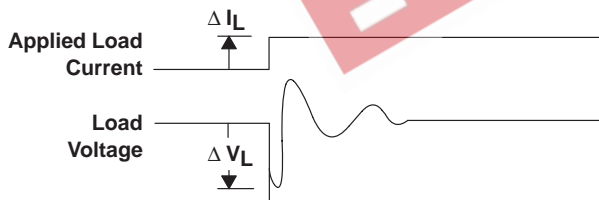
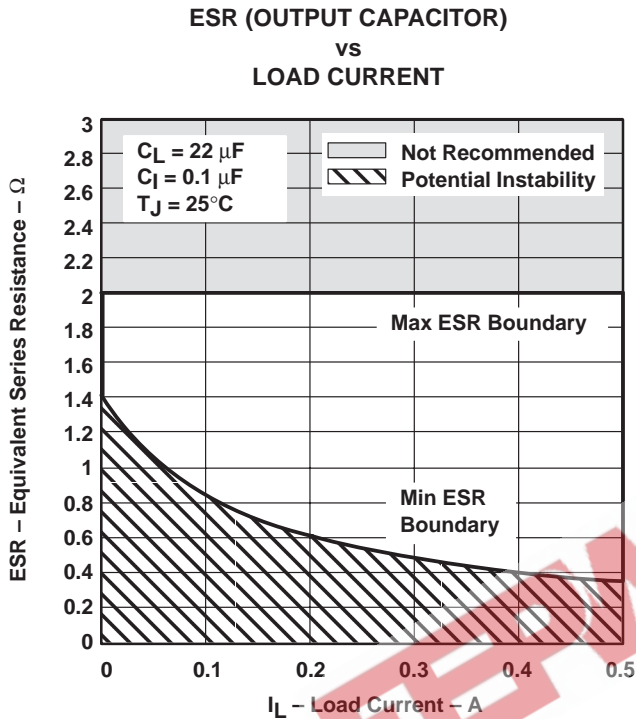

Figure 1

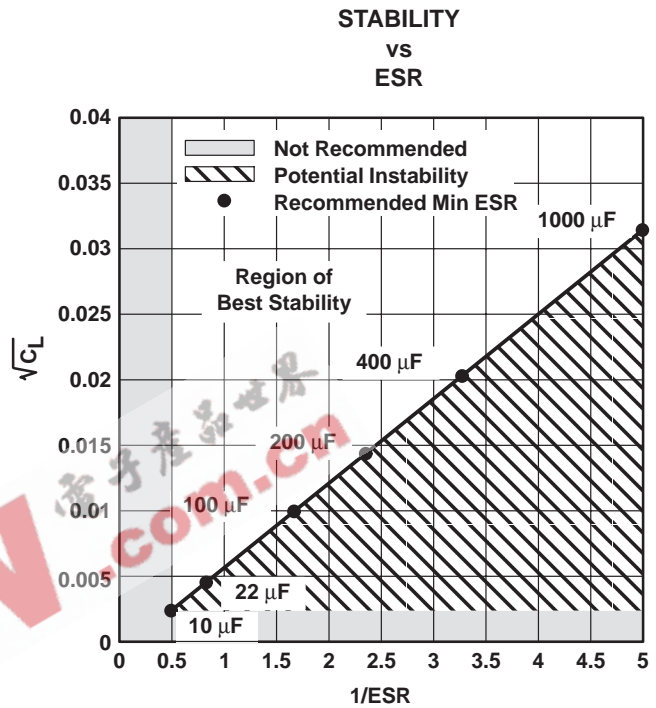

Figure 2

APPLICATION INFORMATION

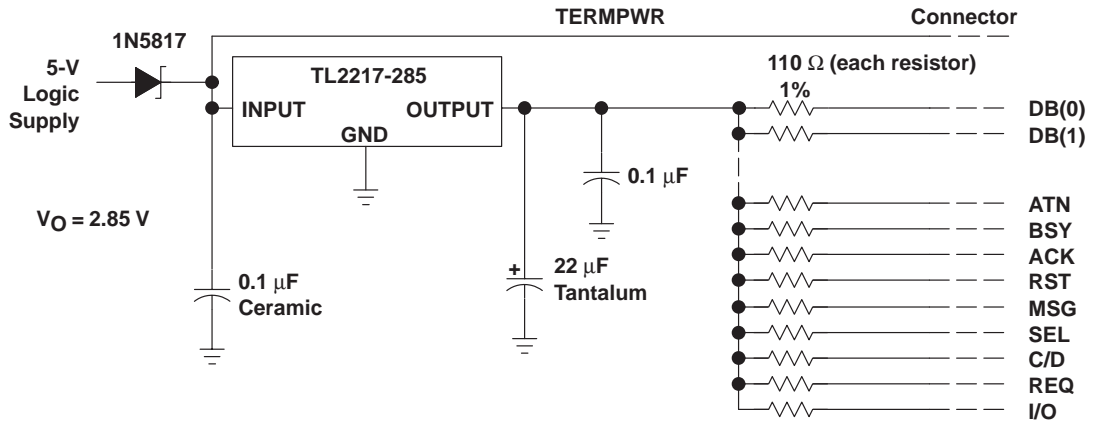

Figure 3. Typical Application Schematic

EEPW 电子产品世界 .com.cn

IMPORTANT NOTICE

Texas Instruments and its subsidiaries (TI) reserve the right to make changes to their products or to discontinue any product or service without notice, and advise customers to obtain the latest version of relevant information to verify, before placing orders, that information being relied on is current and complete. All products are sold subject to the terms and conditions of sale supplied at the time of order acknowledgement, including those pertaining to warranty, patent infringement, and limitation of liability.

TI warrants performance of its semiconductor products to the specifications applicable at the time of sale in accordance with TI's standard warranty. Testing and other quality control techniques are utilized to the extent TI deems necessary to support this warranty. Specific testing of all parameters of each device is not necessarily performed, except those mandated by government requirements.

CERTAIN APPLICATIONS USING SEMICONDUCTOR PRODUCTS MAY INVOLVE POTENTIAL RISKS OF DEATH, PERSONAL INJURY, OR SEVERE PROPERTY OR ENVIRONMENTAL DAMAGE ("CRITICAL APPLICATIONS"). TI SEMICONDUCTOR PRODUCTS ARE NOT DESIGNED, AUTHORIZED, OR WARRANTED TO BE SUITABLE FOR USE IN LIFE-SUPPORT DEVICES OR SYSTEMS OR OTHER CRITICAL APPLICATIONS. INCLUSION OF TI PRODUCTS IN SUCH APPLICATIONS IS UNDERSTOOD TO BE FULLY AT THE CUSTOMER'S RISK.

In order to minimize risks associated with the customer's applications, adequate design and operating safeguards must be provided by the customer to minimize inherent or procedural hazards.

TI assumes no liability for applications assistance or customer product design. TI does not warrant or represent that any license, either express or implied, is granted under any patent right, copyright, mask work right, or other intellectual property right of TI covering or relating to any combination, machine, or process in which such semiconductor products or services might be or are used. TI's publication of information regarding any third party's products or services does not constitute TI's approval, warranty or endorsement thereof.