

FEATURES

- Operating Voltage... ± 2 V to ± 18 V
- Low Offset Voltage...1 mV Max at 25°C, TL5580A
- Wide GBW...12 MHz Typ
- Slew Rate...5 V/ μ s Typ
- Low THD...0.0005% Typ
- Low-Noise Voltage...7 nV/ $\sqrt{\text{Hz}}$ at 1 kHz Typ

APPLICATIONS

- Audio
- Test Equipment
- Industrial Process Controls
- Data-Acquisition Systems
- Active Filters
- Power-Supply Regulation

D, P, OR PW PACKAGE
(TOP VIEW)

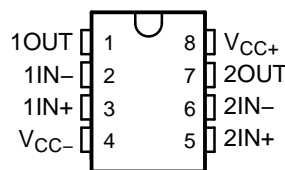

DESCRIPTION/ORDERING INFORMATION

The TL5580 is a dual bipolar operational amplifier that combines both high dc and ac performance with its low offset voltage, high-gain bandwidth, low harmonic distortion, and low-noise characteristics. In addition, its output is capable of driving 600- Ω loads. All these characteristics make the device ideally suited for use in audio, active filtering, and industrial measurement applications.

ORDERING INFORMATION

T_A	V_{IO} (25°C, MAX)	PACKAGE (1)		ORDERABLE PART NUMBER	TOP-SIDE MARKING
-40°C to 85°C	Standard grade 1.5 mV	PDIP – P	Tube of 50	TL5580IP	TL5580IP
		SOIC – D	Tube of 75	TL5580ID	Z5580
			Reel of 2500	TL5580IDR	
		TSSOP – PW	Tube of 150	TL5580IPW	Z5580
			Reel of 2000	TL5580IPWR	
		A grade 1 mV	PDIP – P	Tube of 50	TL5580AIP
	SOIC – D		Tube of 75	TL5580AID	Z5580A
			Reel of 2500	TL5580AIDR	
	TSSOP – PW		Tube of 150	TL5580AIPW	Z5580A
			Reel of 2000	TL5580AIPWR	

(1) Package drawings, standard packing quantities, thermal data, symbolization, and PCB design guidelines are available at www.ti.com/sc/package.



Please be aware that an important notice concerning availability, standard warranty, and use in critical applications of Texas Instruments semiconductor products and disclaimers thereto appears at the end of this data sheet.

TL5580, TL5580A
DUAL LOW-NOISE WIDE-BANDWIDTH PRECISION AMPLIFIER

SLOS477A-JUNE 2005-REVISED JULY 2005

EQUIVALENT SCHEMATIC

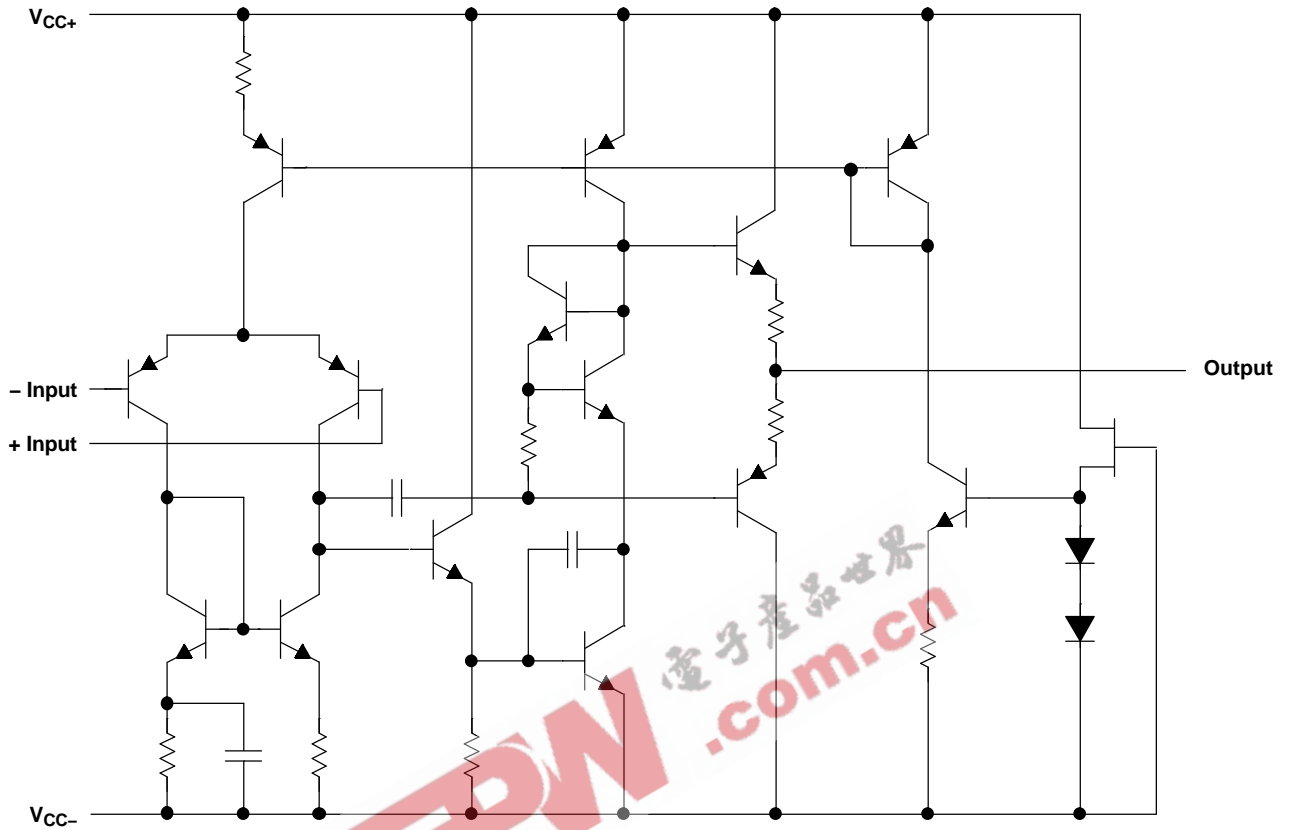

Absolute Maximum Ratings⁽¹⁾

over operating free-air temperature range (unless otherwise noted)

		MIN	MAX	UNIT
V _{CC±}	Supply voltage		±18	V
V _I	Input voltage (any input)		±15	V
V _{ID}	Differential input voltage		±30	V
I _O	Output current		±50	mA
θ _{JA}	Package thermal impedance ⁽²⁾⁽³⁾	D package		97
		P package		85
		PW package		149
T _J	Operating virtual junction temperature		150	°C
T _{stg}	Storage temperature range	–60	125	°C

- (1) Stresses beyond those listed under “absolute maximum ratings” may cause permanent damage to the device. These are stress ratings only, and functional operation of the device at these or any other conditions beyond those indicated under “recommended operating conditions” is not implied. Exposure to absolute-maximum-rated conditions for extended periods may affect device reliability.
- (2) Maximum power dissipation is a function of T_{J(max)}, θ_{JA}, and T_A. The maximum allowable power dissipation at any allowable ambient temperature is P_D = (T_{J(max)} – T_A)/θ_{JA}. Operating at the absolute maximum T_J of 150°C can affect reliability.
- (3) The package thermal impedance is calculated in accordance with JESD 51-7.

Recommended Operating Conditions

		MIN	MAX	UNIT
V _{CC+}	Supply voltage	2	16	V
V _{CC-}		–2	–16	
T _A	Operating free-air temperature	–40	85	°C

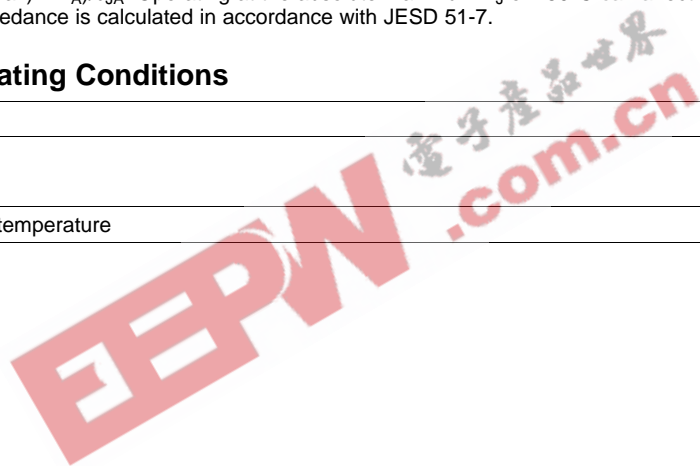

TL5580, TL5580A DUAL LOW-NOISE WIDE-BANDWIDTH PRECISION AMPLIFIER

SLOS477A–JUNE 2005–REVISED JULY 2005

Electrical Characteristics

$V_{CC\pm} = \pm 15\text{ V}$ (unless otherwise noted)

PARAMETER		TEST CONDITIONS	T_A	MIN	TYP	MAX	UNIT
V_{IO}	Input offset voltage	$R_S \leq 10\text{ k}\Omega$	25°C	0.3	1		mV
			-40°C to 85°C		1.35		
			25°C	0.3	1.5		
			-40°C to 85°C		2		
αV_{IO}	Average temperature coefficient of input offset voltage		-40°C to 85°C	1.8	5		$\mu\text{V}/^\circ\text{C}$
I_{IO}	Input offset current		25°C	5	75		nA
			-40°C to 85°C		100		
I_{IB}	Input bias current		25°C	100	500		nA
			-40°C to 85°C		800		
A_{VD}	Large-signal differential-voltage amplification	$R_L \geq 2\text{ k}\Omega, V_O = \pm 10\text{ V}$	25°C	90	110		dB
			-40°C to 85°C		87		
V_{OM}	Output voltage swing	$R_L \geq 2\text{ k}\Omega$	25°C	12.75 -12.25	± 13.5		V
			-40°C to 85°C		12.5 -12		
V_{ICR}	Common-mode input voltage range		25°C	± 13	± 13.5		V
			-40°C to 85°C		± 12		
CMRR	Common-mode rejection ratio	$R_S \leq 10\text{ k}\Omega, V_{ICR} = -12\text{ V to } 12\text{ V}$	25°C	90	110		dB
			-40°C to 85°C		85		
$k_{SVR}^{(1)}$	Supply-voltage rejection ratio	$R_S \leq 10\text{ k}\Omega$	25°C	85	110		dB
			-40°C to 85°C		83		
I_{CC}	Supply current (all amplifiers)		25°C	6	9		mA
			-40°C to 85°C		12		

(1) Measured with $V_{CC\pm}$ varied simultaneously

Operating Characteristics

$V_{CC\pm} = \pm 15\text{ V}, T_A = 25^\circ\text{C}$ (unless otherwise noted)

PARAMETER		TEST CONDITIONS	TYP	UNIT
SR	Slew rate at unity gain	$R_L \geq 2\text{ k}\Omega$	5	$\text{V}/\mu\text{s}$
GBW	Gain bandwidth product	$f = 10\text{ kHz}$	12	MHz
THD	Total harmonic distortion	$V_O = 5\text{ V}, R_L = 2\text{ k}\Omega, f = 1\text{ kHz}, A_{VD} = 20\text{ dB}$	0.0005	%
V_n	Equivalent input noise voltage	$f = 1\text{ kHz}$	7	$\text{nV}/\sqrt{\text{Hz}}$

TYPICAL CHARACTERISTICS

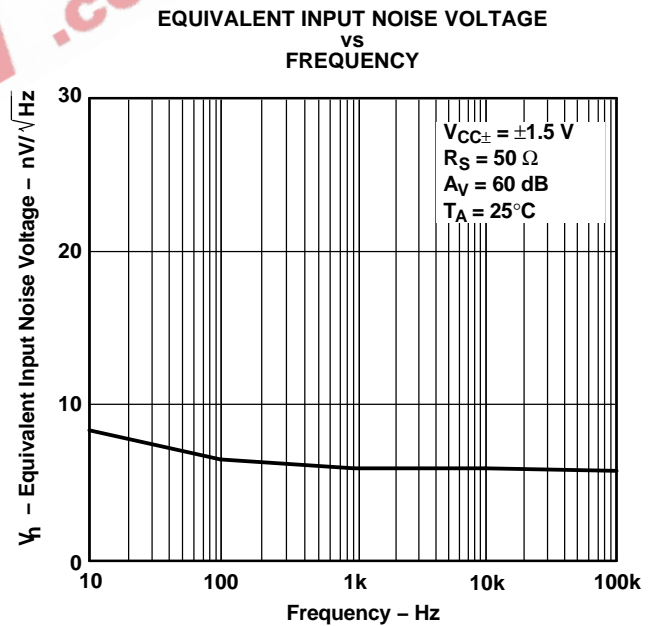
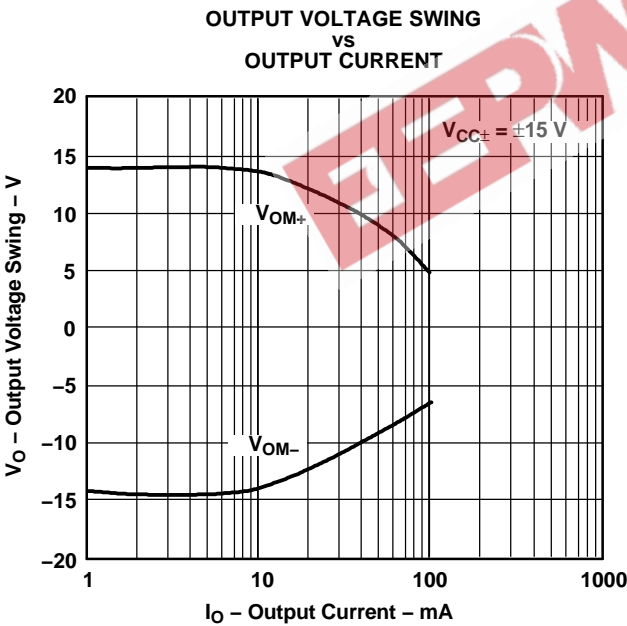
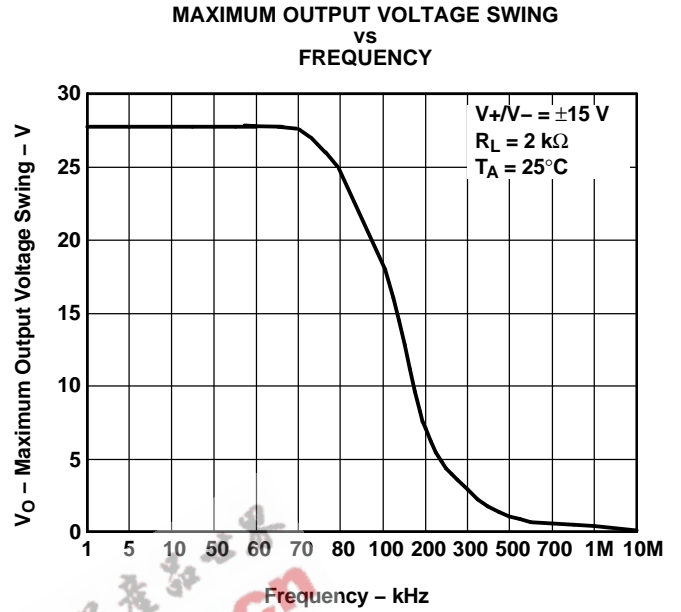
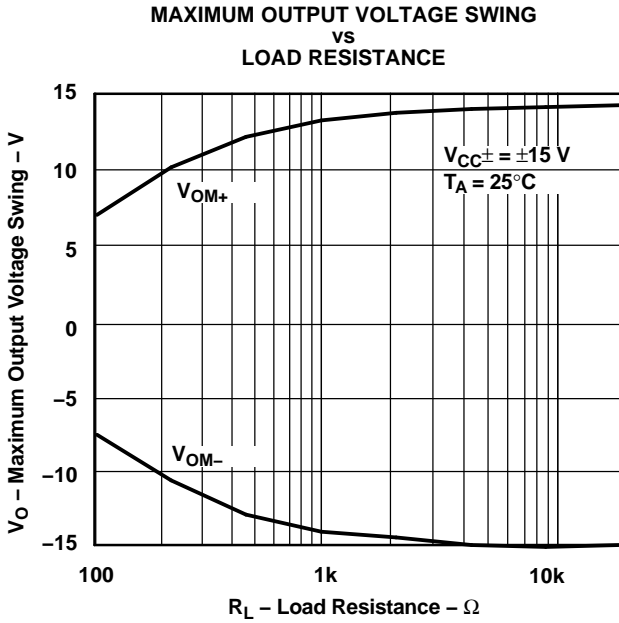

TL5580, TL5580A
 DUAL LOW-NOISE WIDE-BANDWIDTH PRECISION AMPLIFIER

SLOS477A-JUNE 2005-REVISED JULY 2005

TYPICAL CHARACTERISTICS (continued)

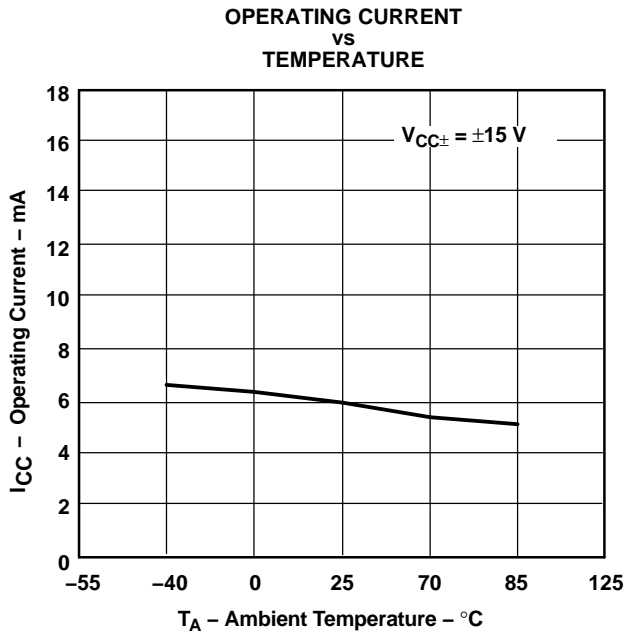

Figure 5.

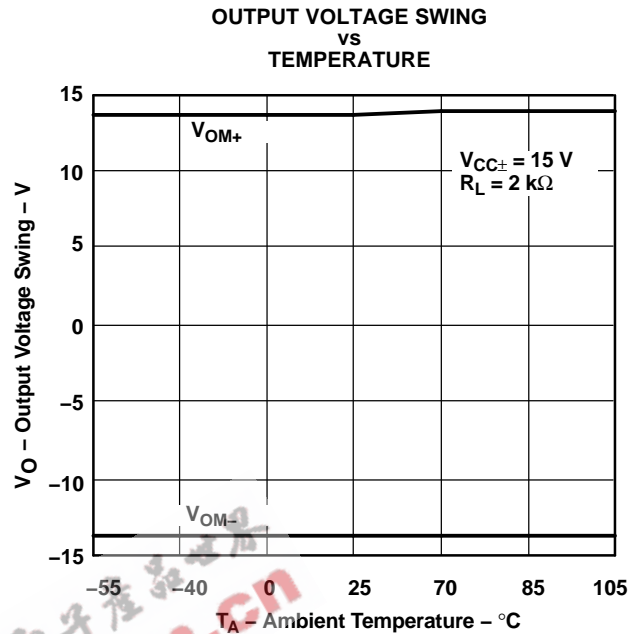

Figure 6.

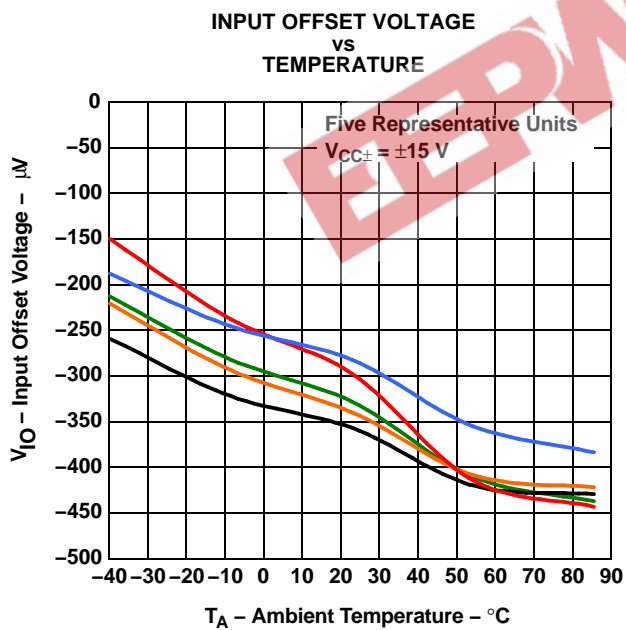

Figure 7.

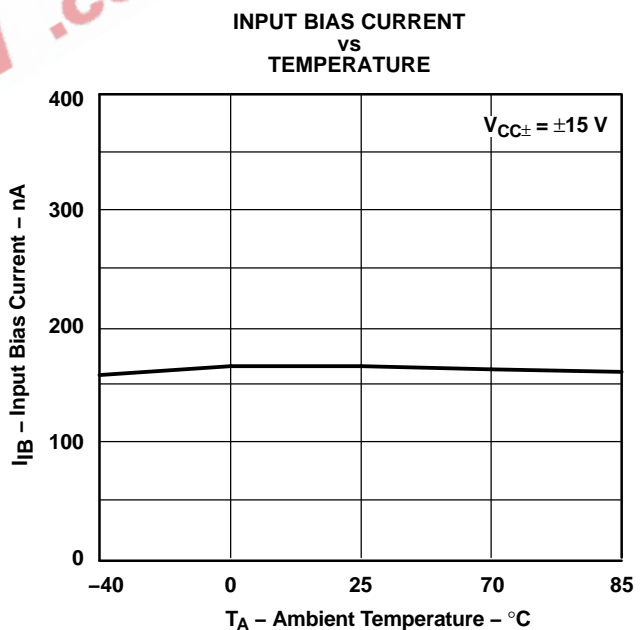

Figure 8.

TYPICAL CHARACTERISTICS (continued)

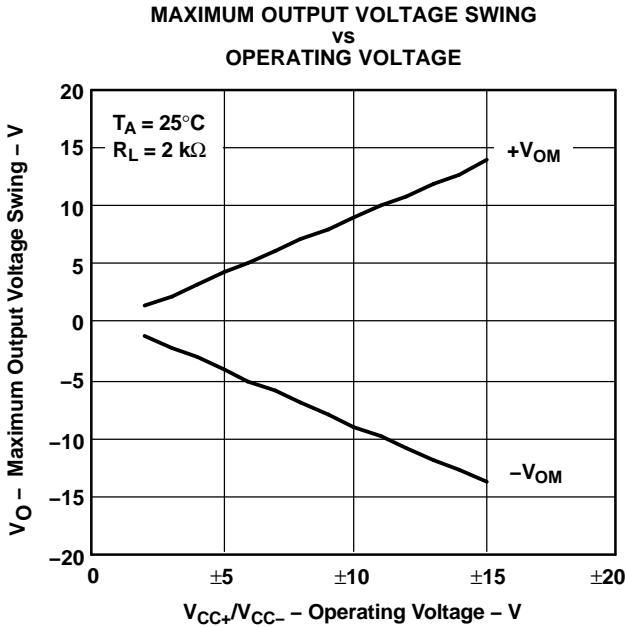

Figure 9.

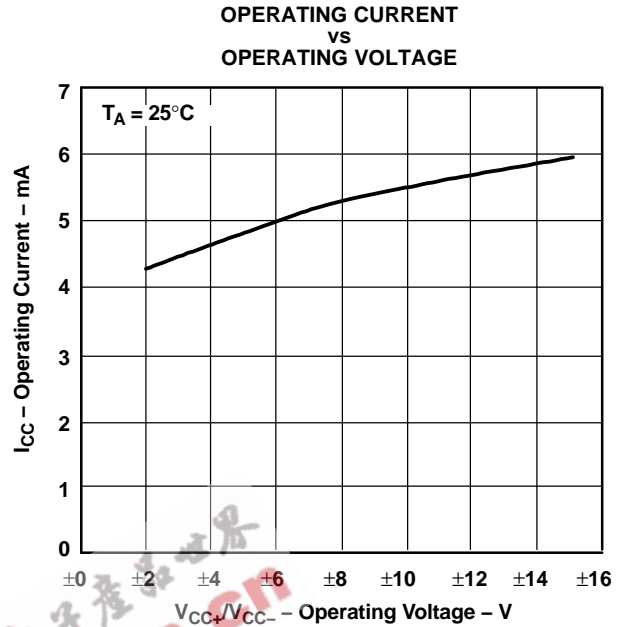

Figure 10.

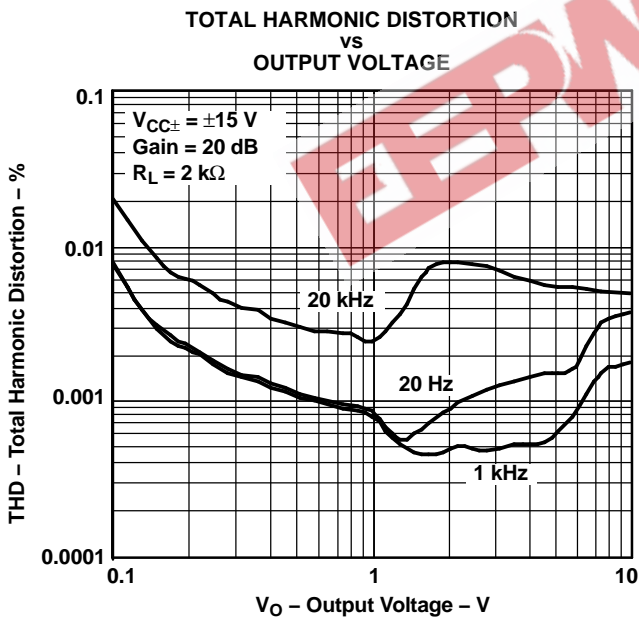

Figure 11.

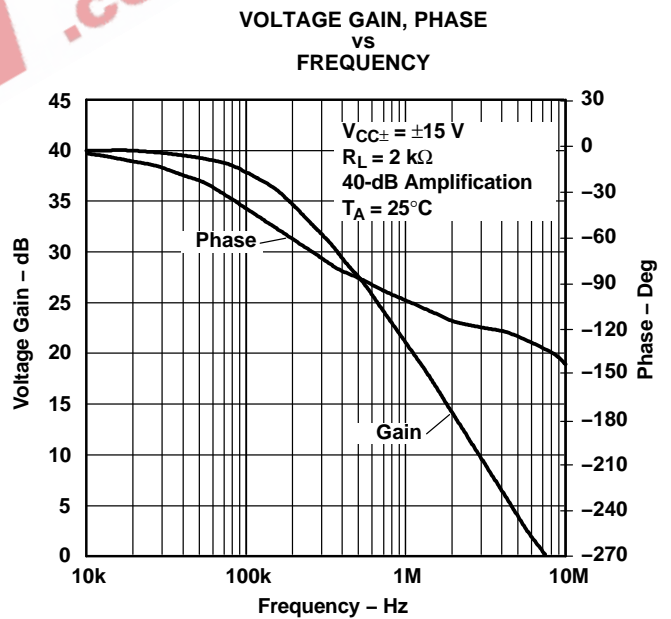

Figure 12.

PACKAGING INFORMATION

Orderable Device	Status ⁽¹⁾	Package Type	Package Drawing	Pins	Package Qty	Eco Plan ⁽²⁾	Lead/Ball Finish	MSL Peak Temp ⁽³⁾
TL5580AID	ACTIVE	SOIC	D	8	75	Green (RoHS & no Sb/Br)	CU NIPDAU	Level-1-260C-UNLIM
TL5580AIDE4	ACTIVE	SOIC	D	8	75	Green (RoHS & no Sb/Br)	CU NIPDAU	Level-1-260C-UNLIM
TL5580AIDR	ACTIVE	SOIC	D	8	2500	Green (RoHS & no Sb/Br)	CU NIPDAU	Level-1-260C-UNLIM
TL5580AIDRE4	ACTIVE	SOIC	D	8	2500	Green (RoHS & no Sb/Br)	CU NIPDAU	Level-1-260C-UNLIM
TL5580AIP	ACTIVE	PDIP	P	8	50	Pb-Free (RoHS)	CU NIPDAU	N / A for Pkg Type
TL5580AIP E4	ACTIVE	PDIP	P	8	50	Pb-Free (RoHS)	CU NIPDAU	N / A for Pkg Type
TL5580AIPW	ACTIVE	TSSOP	PW	8	150	Green (RoHS & no Sb/Br)	CU NIPDAU	Level-1-260C-UNLIM
TL5580AIPWE4	ACTIVE	TSSOP	PW	8	150	Green (RoHS & no Sb/Br)	CU NIPDAU	Level-1-260C-UNLIM
TL5580AIPWR	ACTIVE	TSSOP	PW	8	2000	Green (RoHS & no Sb/Br)	CU NIPDAU	Level-1-260C-UNLIM
TL5580AIPWRE4	ACTIVE	TSSOP	PW	8	2000	Green (RoHS & no Sb/Br)	CU NIPDAU	Level-1-260C-UNLIM
TL5580ID	ACTIVE	SOIC	D	8	75	Green (RoHS & no Sb/Br)	CU NIPDAU	Level-1-260C-UNLIM
TL5580IDE4	ACTIVE	SOIC	D	8	75	Green (RoHS & no Sb/Br)	CU NIPDAU	Level-1-260C-UNLIM
TL5580IDR	ACTIVE	SOIC	D	8	2500	Green (RoHS & no Sb/Br)	CU NIPDAU	Level-1-260C-UNLIM
TL5580IDRE4	ACTIVE	SOIC	D	8	2500	Green (RoHS & no Sb/Br)	CU NIPDAU	Level-1-260C-UNLIM
TL5580IP	ACTIVE	PDIP	P	8	50	Pb-Free (RoHS)	CU NIPDAU	N / A for Pkg Type
TL5580IPE4	ACTIVE	PDIP	P	8	50	Pb-Free (RoHS)	CU NIPDAU	N / A for Pkg Type
TL5580IPW	ACTIVE	TSSOP	PW	8	150	Green (RoHS & no Sb/Br)	CU NIPDAU	Level-1-260C-UNLIM
TL5580IPWE4	ACTIVE	TSSOP	PW	8	150	Green (RoHS & no Sb/Br)	CU NIPDAU	Level-1-260C-UNLIM
TL5580IPWR	ACTIVE	TSSOP	PW	8	2000	Green (RoHS & no Sb/Br)	CU NIPDAU	Level-1-260C-UNLIM
TL5580IPWRE4	ACTIVE	TSSOP	PW	8	2000	Green (RoHS & no Sb/Br)	CU NIPDAU	Level-1-260C-UNLIM

⁽¹⁾ The marketing status values are defined as follows:

ACTIVE: Product device recommended for new designs.

LIFEBUY: TI has announced that the device will be discontinued, and a lifetime-buy period is in effect.

NRND: Not recommended for new designs. Device is in production to support existing customers, but TI does not recommend using this part in a new design.

PREVIEW: Device has been announced but is not in production. Samples may or may not be available.

OBSOLETE: TI has discontinued the production of the device.

⁽²⁾ Eco Plan - The planned eco-friendly classification: Pb-Free (RoHS), Pb-Free (RoHS Exempt), or Green (RoHS & no Sb/Br) - please check <http://www.ti.com/productcontent> for the latest availability information and additional product content details.

TBD: The Pb-Free/Green conversion plan has not been defined.

Pb-Free (RoHS): TI's terms "Lead-Free" or "Pb-Free" mean semiconductor products that are compatible with the current RoHS requirements for all 6 substances, including the requirement that lead not exceed 0.1% by weight in homogeneous materials. Where designed to be soldered at high temperatures, TI Pb-Free products are suitable for use in specified lead-free processes.

Pb-Free (RoHS Exempt): This component has a RoHS exemption for either 1) lead-based flip-chip solder bumps used between the die and package, or 2) lead-based die adhesive used between the die and leadframe. The component is otherwise considered Pb-Free (RoHS compatible) as defined above.

Green (RoHS & no Sb/Br): TI defines "Green" to mean Pb-Free (RoHS compatible), and free of Bromine (Br) and Antimony (Sb) based flame retardants (Br or Sb do not exceed 0.1% by weight in homogeneous material)

⁽³⁾ MSL, Peak Temp. -- The Moisture Sensitivity Level rating according to the JEDEC industry standard classifications, and peak solder temperature.

Important Information and Disclaimer:The information provided on this page represents TI's knowledge and belief as of the date that it is provided. TI bases its knowledge and belief on information provided by third parties, and makes no representation or warranty as to the accuracy of such information. Efforts are underway to better integrate information from third parties. TI has taken and continues to take reasonable steps to provide representative and accurate information but may not have conducted destructive testing or chemical analysis on incoming materials and chemicals. TI and TI suppliers consider certain information to be proprietary, and thus CAS numbers and other limited information may not be available for release.

In no event shall TI's liability arising out of such information exceed the total purchase price of the TI part(s) at issue in this document sold by TI to Customer on an annual basis.



MECHANICAL DATA

MPDI001A – JANUARY 1995 – REVISED JUNE 1999

P (R-PDIP-T8)

PLASTIC DUAL-IN-LINE

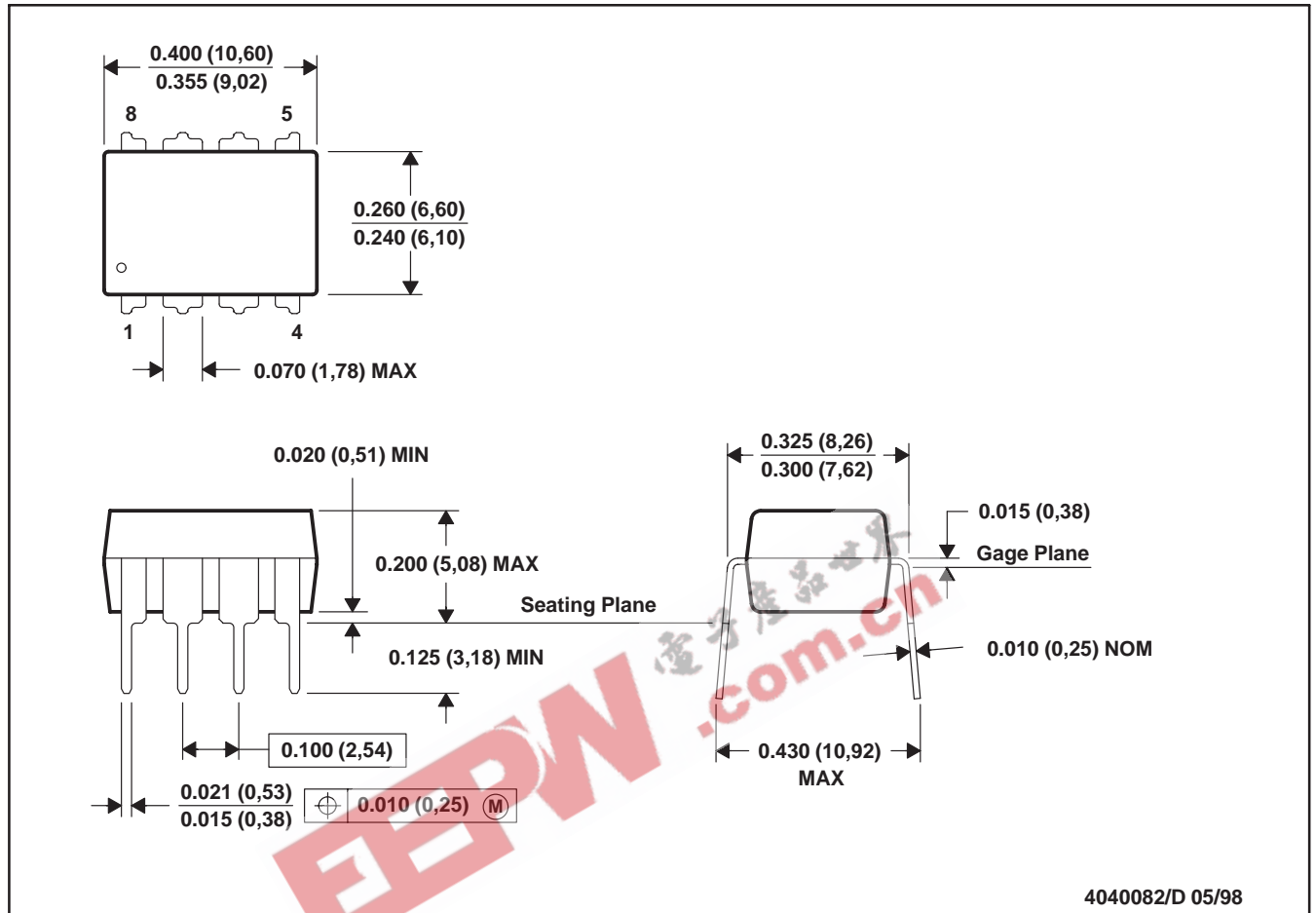

- NOTES: A. All linear dimensions are in inches (millimeters).
 B. This drawing is subject to change without notice.
 C. Falls within JEDEC MS-001

For the latest package information, go to http://www.ti.com/sc/docs/package/pkg_info.htm



POST OFFICE BOX 655303 • DALLAS, TEXAS 75265

MECHANICAL DATA

D (R-PDSO-G8)

PLASTIC SMALL-OUTLINE PACKAGE

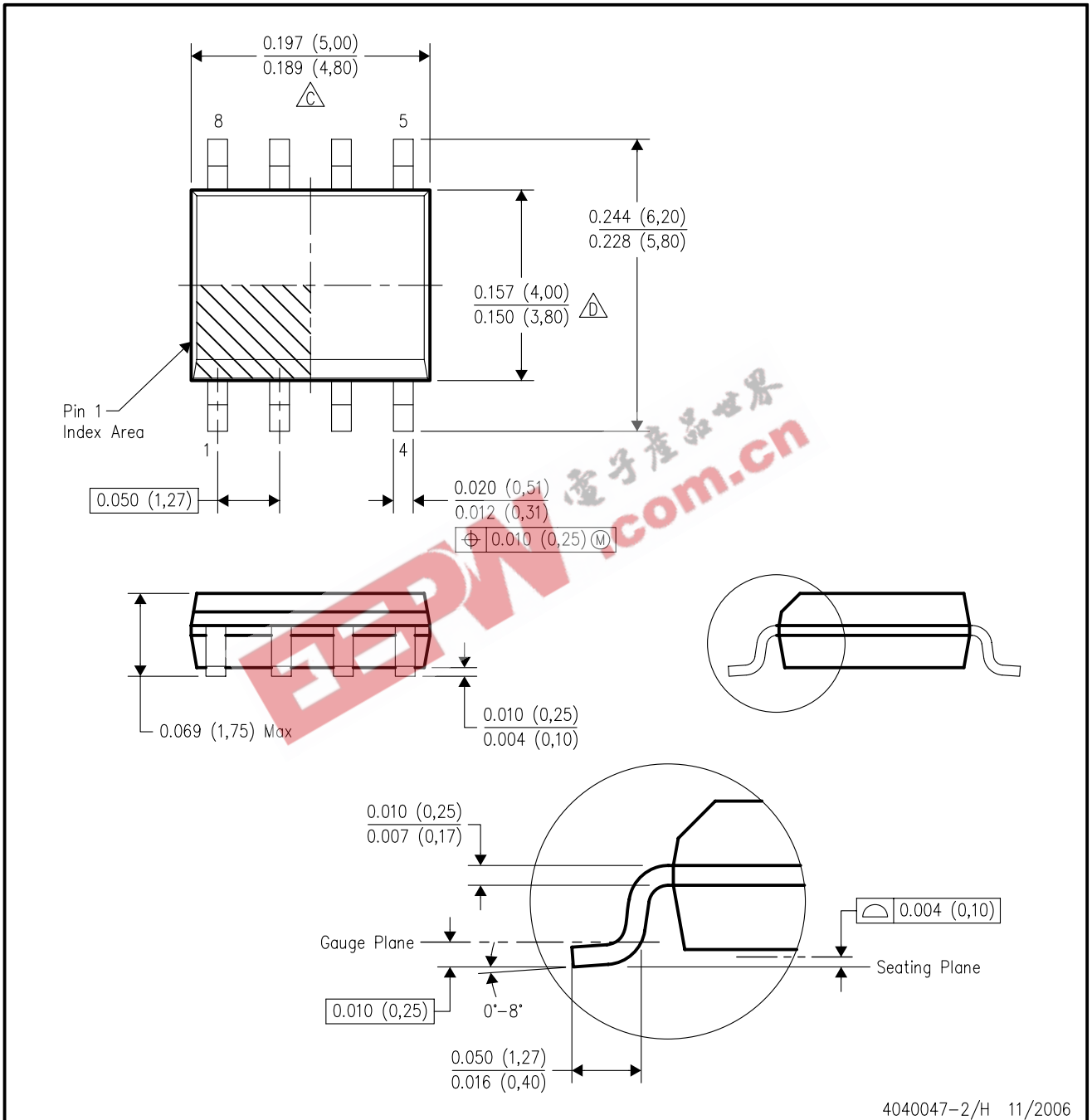

- NOTES:
- A. All linear dimensions are in inches (millimeters).
 - B. This drawing is subject to change without notice.
 - C. Body length does not include mold flash, protrusions, or gate burrs. Mold flash, protrusions, or gate burrs shall not exceed .006 (0,15) per end.
 - D. Body width does not include interlead flash. Interlead flash shall not exceed .017 (0,43) per side.
 - E. Reference JEDEC MS-012 variation AA.

MECHANICAL DATA

MTSS001C – JANUARY 1995 – REVISED FEBRUARY 1999

PW (R-PDSO-G**)

PLASTIC SMALL-OUTLINE PACKAGE

14 PINS SHOWN



4040064/F 01/97

- NOTES: A. All linear dimensions are in millimeters.
 B. This drawing is subject to change without notice.
 C. Body dimensions do not include mold flash or protrusion not to exceed 0,15.
 D. Falls within JEDEC MO-153

IMPORTANT NOTICE

Texas Instruments Incorporated and its subsidiaries (TI) reserve the right to make corrections, modifications, enhancements, improvements, and other changes to its products and services at any time and to discontinue any product or service without notice. Customers should obtain the latest relevant information before placing orders and should verify that such information is current and complete. All products are sold subject to TI's terms and conditions of sale supplied at the time of order acknowledgment.

TI warrants performance of its hardware products to the specifications applicable at the time of sale in accordance with TI's standard warranty. Testing and other quality control techniques are used to the extent TI deems necessary to support this warranty. Except where mandated by government requirements, testing of all parameters of each product is not necessarily performed.

TI assumes no liability for applications assistance or customer product design. Customers are responsible for their products and applications using TI components. To minimize the risks associated with customer products and applications, customers should provide adequate design and operating safeguards.

TI does not warrant or represent that any license, either express or implied, is granted under any TI patent right, copyright, mask work right, or other TI intellectual property right relating to any combination, machine, or process in which TI products or services are used. Information published by TI regarding third-party products or services does not constitute a license from TI to use such products or services or a warranty or endorsement thereof. Use of such information may require a license from a third party under the patents or other intellectual property of the third party, or a license from TI under the patents or other intellectual property of TI.

Reproduction of information in TI data books or data sheets is permissible only if reproduction is without alteration and is accompanied by all associated warranties, conditions, limitations, and notices. Reproduction of this information with alteration is an unfair and deceptive business practice. TI is not responsible or liable for such altered documentation.

Resale of TI products or services with statements different from or beyond the parameters stated by TI for that product or service voids all express and any implied warranties for the associated TI product or service and is an unfair and deceptive business practice. TI is not responsible or liable for any such statements.

Following are URLs where you can obtain information on other Texas Instruments products and application solutions:

Products		Applications	
Amplifiers	amplifier.ti.com	Audio	www.ti.com/audio
Data Converters	dataconverter.ti.com	Automotive	www.ti.com/automotive
DSP	dsp.ti.com	Broadband	www.ti.com/broadband
Interface	interface.ti.com	Digital Control	www.ti.com/digitalcontrol
Logic	logic.ti.com	Military	www.ti.com/military
Power Mgmt	power.ti.com	Optical Networking	www.ti.com/opticalnetwork
Microcontrollers	microcontroller.ti.com	Security	www.ti.com/security
Low Power Wireless	www.ti.com/lpw	Telephony	www.ti.com/telephony
		Video & Imaging	www.ti.com/video
		Wireless	www.ti.com/wireless

Mailing Address: Texas Instruments
Post Office Box 655303 Dallas, Texas 75265