

TL594 PULSE-WIDTH-MODULATION CONTROL CIRCUITS

SLVS052C – APRIL 1988 – REVISED JULY 1999

- Complete PWM Power Control Circuitry
- Uncommitted Outputs for 200-mA Sink or Source Current
- Output Control Selects Single-Ended or Push-Pull Operation
- Internal Circuitry Prohibits Double Pulse at Either Output
- Variable Dead Time Provides Control Over Total Range
- Internal Regulator Provides a Stable 5-V Reference Supply Trimmed to 1%
- Circuit Architecture Allows Easy Synchronization
- Undervoltage Lockout for Low V_{CC} Conditions

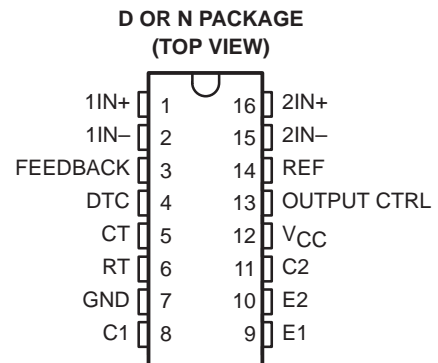

description

The TL594 incorporates all the functions required in the construction of a pulse-width-modulation control circuit on a single chip. Designed primarily for power-supply control, these devices offer the systems engineer the flexibility to tailor the power-supply control circuitry to a specific application.

The TL594 contains two error amplifiers, an on-chip adjustable oscillator, a dead-time control (DTC) comparator, a pulse-steering control flip-flop, a 5-V regulator with a precision of 1%, an undervoltage lockout control circuit, and output control circuitry.

The error amplifiers exhibit a common-mode voltage range from -0.3 V to $V_{CC} - 2\text{ V}$. The DTC comparator has a fixed offset that provides approximately 5% dead time. The on-chip oscillator can be bypassed by terminating RT to the reference output and providing a sawtooth input to CT, or it can be used to drive the common circuitry in synchronous multiple-rail power supplies.

The uncommitted output transistors provide either common-emitter or emitter-follower output capability. Each device provides for push-pull or single-ended output operation, with selection by means of the output-control function. The architecture of these devices prohibits the possibility of either output being pulsed twice during push-pull operation. The undervoltage lockout control circuit locks the outputs off until the internal circuitry is operational.

The TL594C is characterized for operation from 0°C to 70°C . The TL594I is characterized for operation from -40°C to 85°C .

FUNCTION TABLE

INPUT	OUTPUT FUNCTION
OUTPUT CTRL	
$V_I = -0$	Single-ended or parallel output
$V_I = V_{ref}$	Normal push-pull operation



Please be aware that an important notice concerning availability, standard warranty, and use in critical applications of Texas Instruments semiconductor products and disclaimers thereto appears at the end of this data sheet.

PRODUCTION DATA information is current as of publication date. Products conform to specifications per the terms of Texas Instruments standard warranty. Production processing does not necessarily include testing of all parameters.

 **TEXAS
INSTRUMENTS**

POST OFFICE BOX 655303 • DALLAS, TEXAS 75265

Copyright © 1999, Texas Instruments Incorporated

TL594

PULSE-WIDTH-MODULATION CONTROL CIRCUITS

SLVS052C – APRIL 1988 – REVISED JULY 1999

AVAILABLE OPTIONS

T _A	PACKAGED DEVICES		CHIP FORM (Y)
	SMALL OUTLINE (D)	PLASTIC DIP (N)	
0°C to 70°C	TL594CD	TL594CN	TL594Y
-40°C to 85°C	TL594ID	TL594IN	

The D package is available taped and reeled. Add "R" suffix to device type (e.g., TL594CDR). Chip forms are tested at 25°C.

functional block diagram

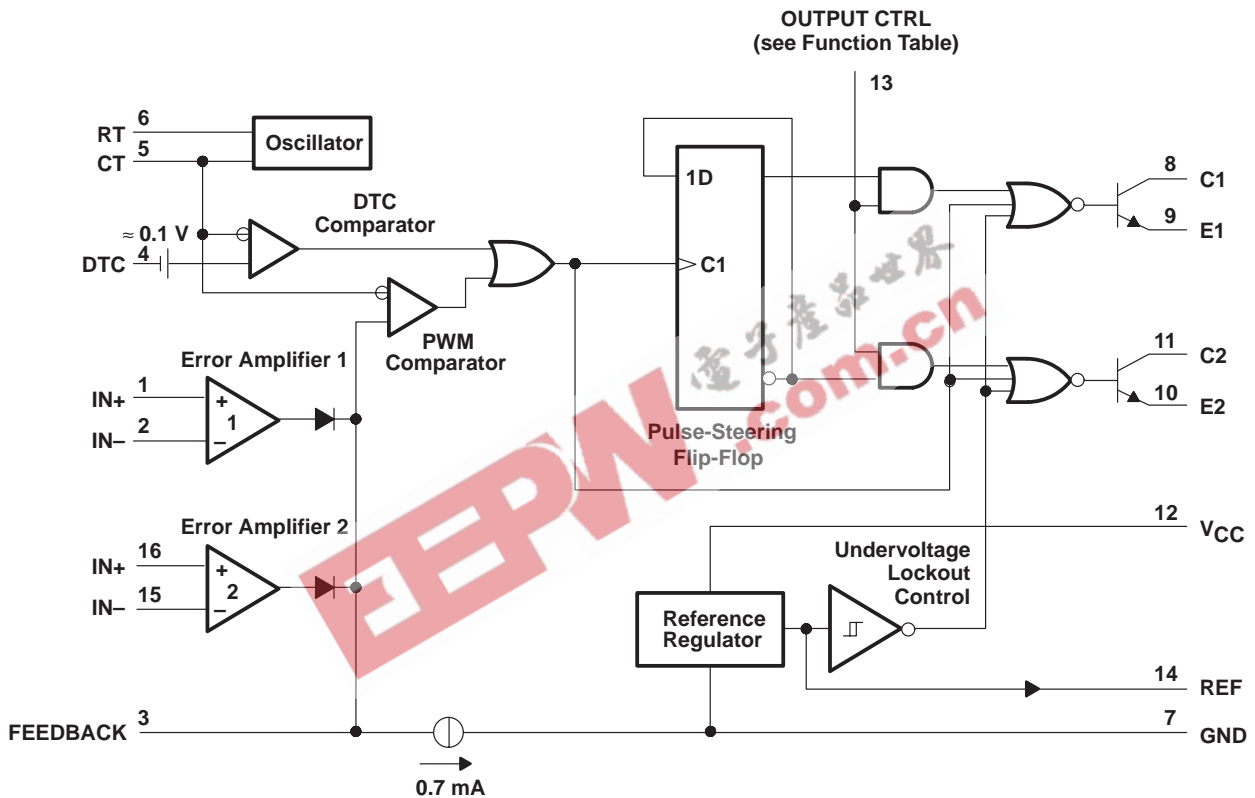

TL594

PULSE-WIDTH-MODULATION CONTROL CIRCUITS

SLVS052C – APRIL 1988 – REVISED JULY 1999

absolute maximum ratings over operating free-air temperature range (unless otherwise noted)†

	TL594X	UNIT
Supply voltage, V_{CC} (see Note 1)	41	V
Amplifier input voltage	$V_{CC}+0.3$	V
Collector output voltage	41	V
Collector output current	250	mA
Package thermal impedance, θ_{JA} (see Notes 2 and 3)	D package	73
	N package	88
Lead temperature 1.6 mm (1/16 inch) from case for 10 seconds	260	°C
Storage temperature range, T_{stg}	-65 to 150	°C

† Stresses beyond those listed under “absolute maximum ratings” may cause permanent damage to the device. These are stress ratings only, and functional operation of the device at these or any other conditions beyond those indicated under “recommended operating conditions” is not implied. Exposure to absolute-maximum-rated conditions for extended periods may affect device reliability.

- NOTES:
1. All voltage values, except differential voltages, are with respect to the network ground terminal.
 2. Maximum power dissipation is a function of $T_J(\max)$, θ_{JA} , and T_A . The maximum allowable power dissipation at any allowable ambient temperature is $P_D = (T_J(\max) - T_A)/\theta_{JA}$. Operating at the absolute maximum T_J of 150°C can impact reliability.
 3. The package thermal impedance is calculated in accordance with JESD 51, except for through-hole packages, which use a trace length of zero.

recommended operating conditions

	MIN	MAX	UNIT
Supply voltage, V_{CC}	7	40	V
Amplifier input voltage, V_I	-0.3	$V_{CC}-2$	V
Collector output voltage, V_O		40	V
Collector output current (each transistor)		200	mA
Current into feedback terminal		0.3	mA
Timing capacitor, C_T	0.47	10000	nF
Timing resistor, R_T	1.8	500	k Ω
Oscillator frequency, f_{osc}	1	300	kHz
Operating free-air temperature, T_A	TL594C	0	70
	TL594I	-40	85

TL594

PULSE-WIDTH-MODULATION CONTROL CIRCUITS

SLVS052C – APRIL 1988 – REVISED JULY 1999

electrical characteristics over recommended operating conditions, $V_{CC} = 15\text{ V}$,
(unless otherwise noted)

reference section

PARAMETER	TEST CONDITIONS†	TL594C, TL594I			UNIT
		MIN	TYP‡	MAX	
Output voltage (REF)	$I_O = 1\text{ mA}$, $T_A = 25^\circ\text{C}$	4.95	5	5.05	V
Input regulation	$V_{CC} = 7\text{ V to }40\text{ V}$, $T_A = 25^\circ\text{C}$		2	25	mV
Output regulation	$I_O = 1\text{ to }10\text{ mA}$, $T_A = 25^\circ\text{C}$		14	35	mV
Output-voltage change with temperature	$\Delta T_A = \text{MIN to MAX}$		2	10	mV/V
Short-circuit output current§	$V_{ref} = 0$	10	35	50	mA

† For conditions shown as MIN or MAX, use the appropriate value specified under recommended operating conditions.

‡ All typical values except for parameter changes with temperature are at $T_A = 25^\circ\text{C}$.

§ Duration of the short circuit should not exceed one second.

amplifier section (see Figure 1)

PARAMETER	TEST CONDITIONS	TL594C, TL594I			UNIT
		MIN	TYP‡	MAX	
Input offset voltage, error amplifier	FEEDBACK = 2.5 V		2	10	mV
Input offset current	FEEDBACK = 2.5 V		25	250	nA
Input bias current	FEEDBACK = 2.5 V		0.2	1	μA
Common-mode input voltage range, error amplifier	$V_{CC} = 7\text{ V to }40\text{ V}$		0.3 to $V_{CC}-2$		V
Open-loop voltage amplification, error amplifier	$\Delta V_O = 3\text{ V}$, $R_L = 2\text{ k}\Omega$, $V_O = 0.5\text{ V to }3.5\text{ V}$		70	95	dB
Unity-gain bandwidth	$V_O = 0.5\text{ V to }3.5\text{ V}$, $R_L = 2\text{ k}\Omega$		800		kHz
Common-mode rejection ratio, error amplifier	$V_{CC} = 40\text{ V}$, $T_A = 25^\circ\text{C}$		65	80	dB
Output sink current, FEEDBACK	$V_{ID} = -15\text{ mV to }-5\text{ V}$, FEEDBACK = 0.5 V		0.3	0.7	mA
Output source current, FEEDBACK	$V_{ID} = 15\text{ mV to }5\text{ V}$, FEEDBACK = 3.5 V		-2		mA

‡ All typical values except for parameter changes with temperature are at $T_A = 25^\circ\text{C}$.

oscillator section, $C_T = 0.01\ \mu\text{F}$, $R_T = 12\text{ k}\Omega$ (see Figure 2)

PARAMETER	TEST CONDITIONS†	TL594C, TL594I			UNIT
		MIN	TYP‡	MAX	
Frequency			10		kHz
Standard deviation of frequency¶	All values of V_{CC} , C_T , R_T , and T_A constant		100		Hz/kHz
Frequency change with voltage	$V_{CC} = 7\text{ V to }40\text{ V}$, $T_A = 25^\circ\text{C}$		1		Hz/kHz
Frequency change with temperature#	$\Delta T_A = \text{MIN to MAX}$			50	Hz/kHz

† For conditions shown as MIN or MAX, use the appropriate value specified under recommended operating conditions.

‡ All typical values except for parameter changes with temperature are at $T_A = 25^\circ\text{C}$.

¶ Standard deviation is a measure of the statistical distribution about the mean as derived from the formula:

$$\sigma = \sqrt{\frac{\sum_{n=1}^N (x_n - \bar{x})^2}{N - 1}}$$

Temperature coefficient of timing capacitor and timing resistor not taken into account.

TL594

PULSE-WIDTH-MODULATION CONTROL CIRCUITS

SLVS052C – APRIL 1988 – REVISED JULY 1999

electrical characteristics over recommended operating free-air temperature range, $V_{CC} = 15\text{ V}$, (unless otherwise noted)

dead-time control section (see Figure 2)

PARAMETER	TEST CONDITIONS	TL594C, TL594I			UNIT
		MIN	TYP†	MAX	
Input bias current	$V_I = 0$ to 5.25 V		-2	-10	μA
Maximum duty cycle, each output	DTC = 0 V	0.45			
Input threshold voltage	Zero duty cycle		3	3.3	V
	Maximum duty cycle	0			

† All typical values except for parameter changes with temperature are at $T_A = 25^\circ\text{C}$.

output section

PARAMETER	TEST CONDITIONS	TL594C, TL594I			UNIT
		MIN	TYP†	MAX	
Collector off-state current	$V_C = 40\text{ V}$, $V_E = 0\text{ V}$, $V_{CC} = 40\text{ V}$		2	100	μA
	DTC and OUTPUT CTRL = 0 V , $V_C = 15\text{ V}$, $V_E = 0\text{ V}$, $V_{CC} = 1$ to 3 V		4	200	
Emitter off-state current	$V_{CC} = V_C = 40\text{ V}$, $V_E = 0$			-100	μA
Collector-emitter saturation voltage	Common emitter $V_E = 0$, $I_C = 200\text{ mA}$		1.1	1.3	V
	Emitter follower $V_C = 15\text{ V}$, $I_E = -200\text{ mA}$		1.5	2.5	
Output control input current	$V_I = V_{ref}$			3.5	mA

† All typical values except for parameter changes with temperature are at $T_A = 25^\circ\text{C}$.

pwm comparator section (see Figure 2)

PARAMETER	TEST CONDITIONS	TL594C, TL594I			UNIT
		MIN	TYP†	MAX	
Input threshold voltage, FEEDBACK	Zero duty cycle		4	4.5	V
Input sink current, FEEDBACK	FEEDBACK = 0.5 V	0.3	0.7		mA

† All typical values except for parameter changes with temperature are at $T_A = 25^\circ\text{C}$.

undervoltage lockout section (see Figure 2)

PARAMETER	TEST CONDITIONS‡	TL594C, TL594I		UNIT
		MIN	MAX	
Threshold voltage	$T_A = 25^\circ\text{C}$		6	V
	$\Delta T_A = \text{MIN to MAX}$	3.5	6.9	
Hysteresis§		100		mV

‡ For conditions shown as MIN or MAX, use the appropriate value specified under recommended operating conditions.

§ Hysteresis is the difference between the positive-going input threshold voltage and the negative-going input threshold voltage.

PARAMETER	TEST CONDITIONS	TL594C, TL594I			UNIT
		MIN	TYP†	MAX	
Standby supply current	RT at V_{ref} . All other inputs and outputs open	$V_{CC} = 15\text{ V}$	9	15	mA
		$V_{CC} = 40\text{ V}$	11	18	
Average supply current	DTC = 2 V , See Figure 2	12.4			mA

† All typical values except for parameter changes with temperature are at $T_A = 25^\circ\text{C}$.

TL594

PULSE-WIDTH-MODULATION CONTROL CIRCUITS

SLVS052C – APRIL 1988 – REVISED JULY 1999

electrical characteristics over recommended operating free-air temperature range, $V_{CC} = 15\text{ V}$, (unless otherwise noted) (continued)

switching characteristics, $T_A = 25^\circ\text{C}$

PARAMETER	TEST CONDITIONS	TL594C, TL594I			UNIT
		MIN	TYP†	MAX	
Output-voltage rise time	Common-emitter configuration (see Figure 3)		100	200	ns
Output-voltage fall time			30	100	ns
Output-voltage rise time	Emitter-follower configuration (see Figure 4)		200	400	ns
Output-voltage fall time			45	100	ns

† All typical values except for parameter changes with temperature are at $T_A = 25^\circ\text{C}$.

electrical characteristics over recommended operating conditions, $V_{CC} = 15\text{ V}$, $T_A = 25^\circ\text{C}$ (unless otherwise noted)

reference section

PARAMETER	TEST CONDITIONS	TL594Y			UNIT
		MIN	TYP	MAX	
Output voltage (REF)	$I_O = 1\text{ mA}$		5		V
Input regulation	$V_{CC} = 7\text{ V to }40\text{ V}$		2		mV
Output regulation	$I_O = 1\text{ to }10\text{ mA}$		14		mV
Short-circuit output current†	$V_{ref} = 0$		35		mA

† Duration of the short circuit should not exceed one second.

oscillator section, $C_T = 0.01\ \mu\text{F}$, $R_T = 12\ \text{k}\Omega$ (see Figure 2)

PARAMETER	TEST CONDITIONS	TL594Y			UNIT
		MIN	TYP	MAX	
Frequency			10		kHz
Standard deviation of frequency§	All values of V_{CC} , C_T , R_T , and T_A constant		100		Hz/kHz
Frequency change with voltage	$V_{CC} = 7\text{ V to }40\text{ V}$		1		Hz/kHz

§ Standard deviation is a measure of the statistical distribution about the mean as derived from the formula:

$$\sigma = \sqrt{\frac{\sum_{n=1}^N (x_n - \bar{X})^2}{N - 1}}$$

amplifier section (see Figure 1)

PARAMETER	TEST CONDITIONS	TL594Y			UNIT
		MIN	TYP	MAX	
Input offset voltage, error amplifier	FEEDBACK = 2.5 V		2		mV
Input offset current	FEEDBACK = 2.5 V		25		nA
Input bias current	FEEDBACK = 2.5 V		0.2		μA
Open-loop voltage amplification, error amplifier	$\Delta V_O = 3\text{ V}$, $R_L = 2\ \text{k}\Omega$, $V_O = 0.5\text{ V to }3.5\text{ V}$		95		dB
Unity-gain bandwidth	$V_O = 0.5\text{ V to }3.5\text{ V}$, $R_L = 2\ \text{k}\Omega$		800		kHz
Common-mode rejection ratio, error amplifier	$V_{CC} = 40\text{ V}$, $T_A = 25^\circ\text{C}$		80		dB
Output sink current, FEEDBACK	$V_{ID} = -15\text{ mV to }-5\text{ V}$, FEEDBACK = 0.5 V		0.7		mA

TL594

PULSE-WIDTH-MODULATION CONTROL CIRCUITS

SLVS052C – APRIL 1988 – REVISED JULY 1999

electrical characteristics over recommended operating free-air temperature range, $V_{CC} = 15\text{ V}$, $T_A = 25^\circ\text{C}$ (unless otherwise noted)

dead-time control section (see Figure 2)

PARAMETER	TEST CONDITIONS	TL594Y			UNIT
		MIN	TYP	MAX	
Input bias current	$V_I = 0$ to 5.25 V		-2		μA
Input threshold voltage	Zero duty cycle		3		V

output section

PARAMETER	TEST CONDITIONS	TL594Y			UNIT
		MIN	TYP†	MAX	
Collector off-state current	$V_C = 40\text{ V}$, $V_E = 0\text{ V}$, $V_{CC} = 40\text{ V}$		2		μA
	DTC and OUTPUT CTRL = 0 V, $V_C = 15\text{ V}$, $V_E = 0\text{ V}$, $V_{CC} = 1$ to 3 V		4		
Emitter off-state current	$V_{CC} = V_C = 40\text{ V}$, $V_E = 0$				μA
Collector-emitter saturation voltage	Common emitter $V_E = 0$, $I_C = 200\text{ mA}$		1.1		V
	Emitter follower $V_C = 15\text{ V}$, $I_E = -200\text{ mA}$		1.5		

pwm comparator section (see Figure 2)

PARAMETER	TEST CONDITIONS	TL594Y			UNIT
		MIN	TYP	MAX	
Input threshold voltage, FEEDBACK	Zero duty cycle		4		V
Input sink current, FEEDBACK	FEEDBACK = 0.5 V		0.7		mA

total device (see Figure 2)

PARAMETER	TEST CONDITIONS	TL594Y			UNIT
		MIN	TYP	MAX	
Standby supply current	All other inputs and outputs open, R_T at V_{ref}		9		mA
Average supply current	DTC = 2 V, See Figure 2		12.4		mA

switching characteristics, $T_A = 25^\circ\text{C}$

PARAMETER	TEST CONDITIONS	TL594Y			UNIT
		MIN	TYP	MAX	
Output-voltage rise time	Common-emitter configuration (see Figure 3)		100		ns
Output-voltage fall time			30		ns
Output-voltage rise time	Emitter-follower configuration (see Figure 4)		200		ns
Output-voltage fall time			45		ns

TL594 PULSE-WIDTH-MODULATION CONTROL CIRCUITS

SLVS052C – APRIL 1988 – REVISED JULY 1999

PARAMETER MEASUREMENT INFORMATION

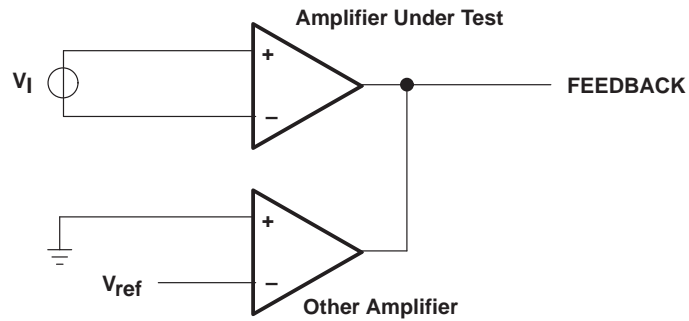

Figure 1. Amplifier-Characteristics Test Circuit

EEPW 电子产品世界 .com.cn

PARAMETER MEASUREMENT INFORMATION

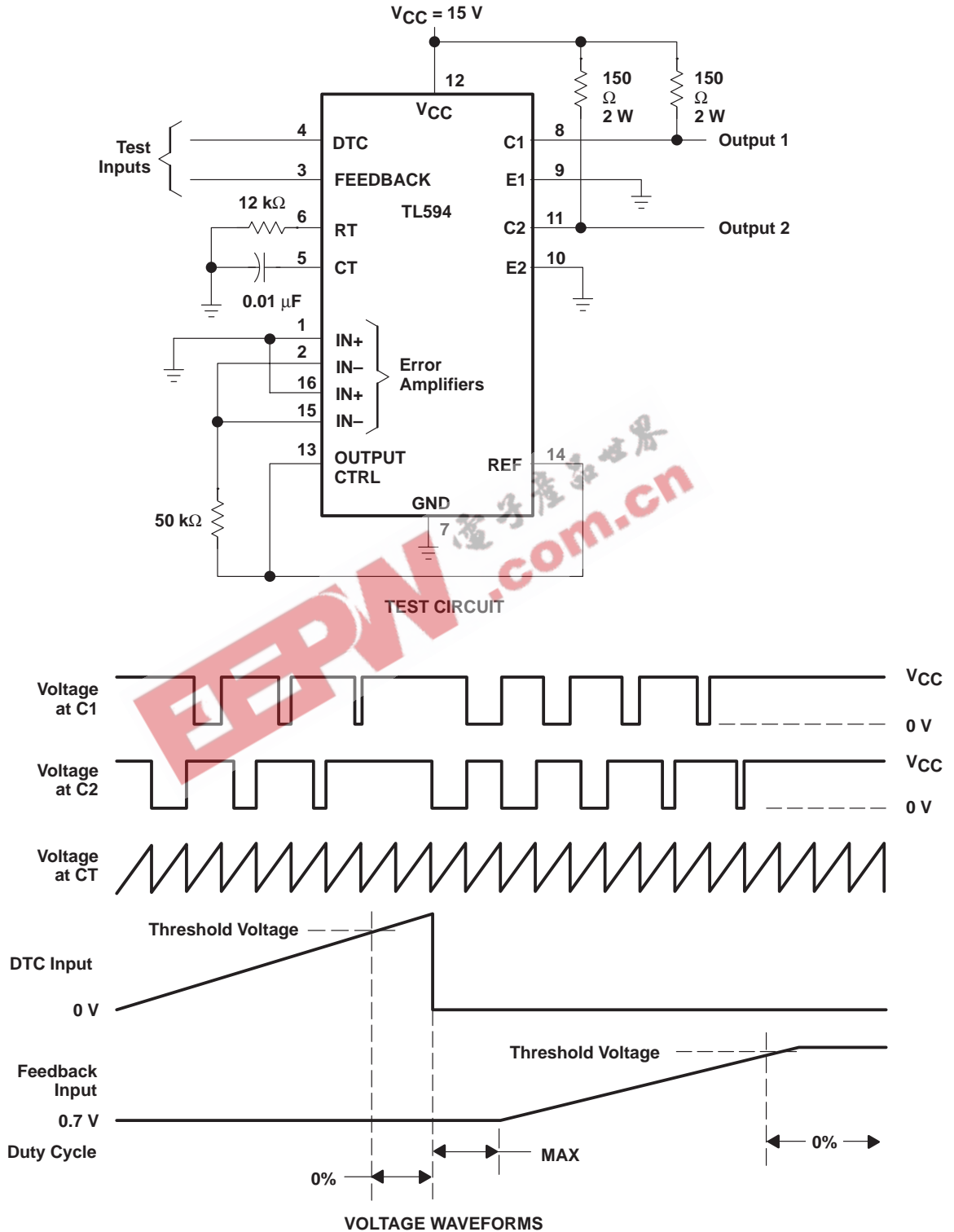

Figure 2. Operational Test Circuit and Waveforms

TL594 PULSE-WIDTH-MODULATION CONTROL CIRCUITS

SLVS052C – APRIL 1988 – REVISED JULY 1999

PARAMETER MEASUREMENT INFORMATION

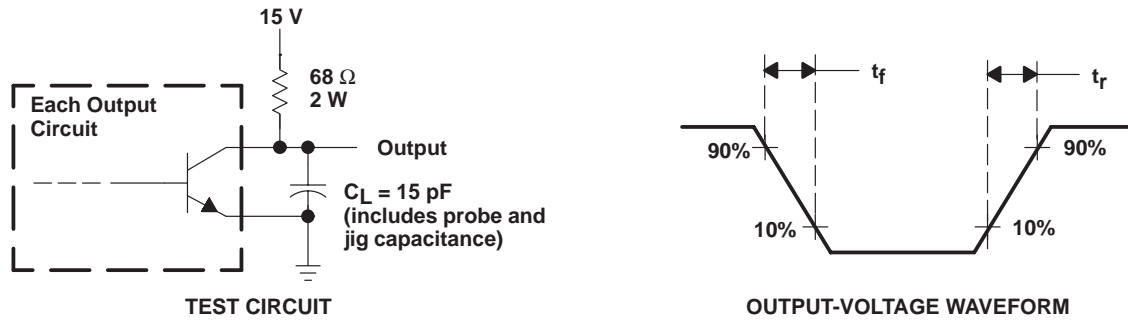

Figure 3. Common-Emitter Configuration

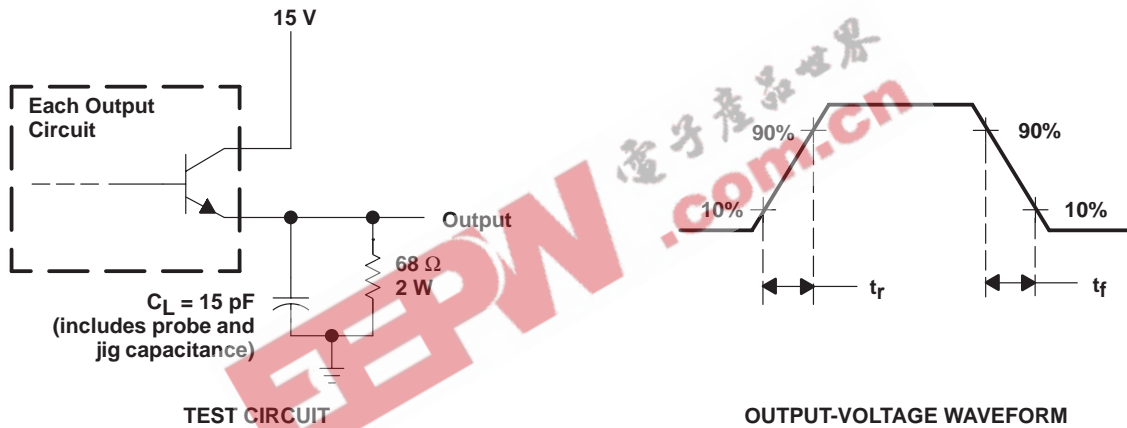
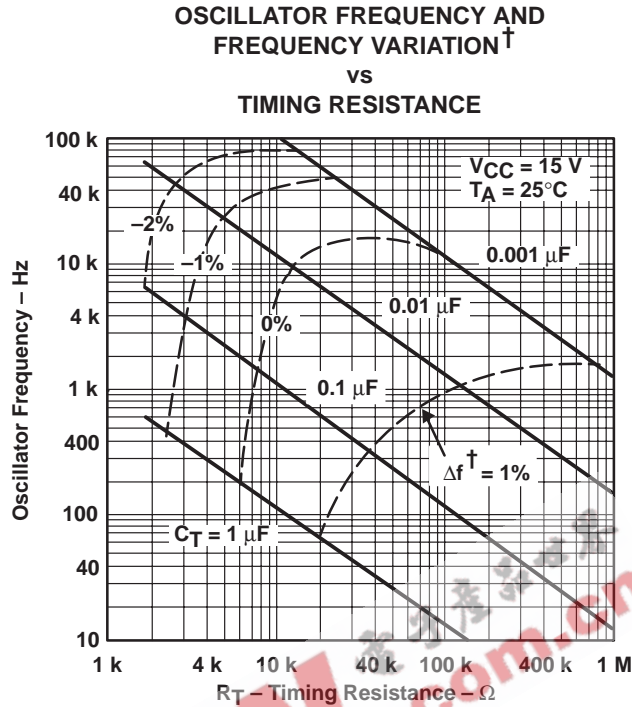

Figure 4. Emitter-Follower Configuration

TYPICAL CHARACTERISTICS



[†] Frequency variation (Δf) is the change in oscillator frequency that occurs over the full temperature range.

Figure 5

AMPLIFIER VOLTAGE AMPLIFICATION
VS
FREQUENCY

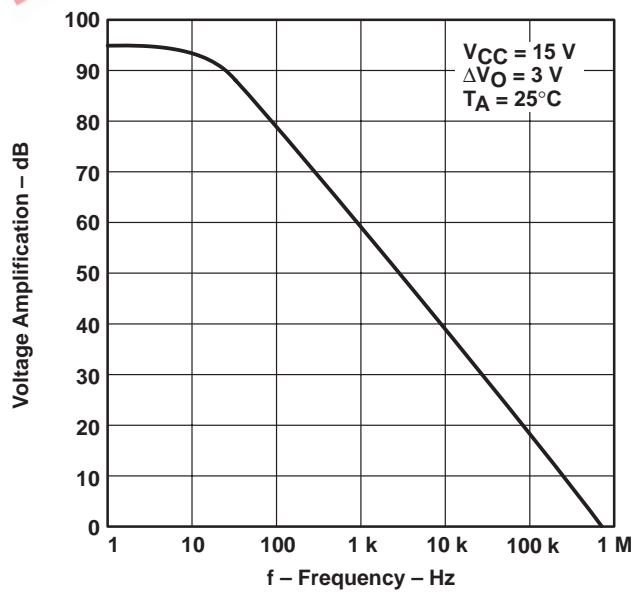

Figure 6

IMPORTANT NOTICE

Texas Instruments and its subsidiaries (TI) reserve the right to make changes to their products or to discontinue any product or service without notice, and advise customers to obtain the latest version of relevant information to verify, before placing orders, that information being relied on is current and complete. All products are sold subject to the terms and conditions of sale supplied at the time of order acknowledgement, including those pertaining to warranty, patent infringement, and limitation of liability.

TI warrants performance of its semiconductor products to the specifications applicable at the time of sale in accordance with TI's standard warranty. Testing and other quality control techniques are utilized to the extent TI deems necessary to support this warranty. Specific testing of all parameters of each device is not necessarily performed, except those mandated by government requirements.

CERTAIN APPLICATIONS USING SEMICONDUCTOR PRODUCTS MAY INVOLVE POTENTIAL RISKS OF DEATH, PERSONAL INJURY, OR SEVERE PROPERTY OR ENVIRONMENTAL DAMAGE ("CRITICAL APPLICATIONS"). TI SEMICONDUCTOR PRODUCTS ARE NOT DESIGNED, AUTHORIZED, OR WARRANTED TO BE SUITABLE FOR USE IN LIFE-SUPPORT DEVICES OR SYSTEMS OR OTHER CRITICAL APPLICATIONS. INCLUSION OF TI PRODUCTS IN SUCH APPLICATIONS IS UNDERSTOOD TO BE FULLY AT THE CUSTOMER'S RISK.

In order to minimize risks associated with the customer's applications, adequate design and operating safeguards must be provided by the customer to minimize inherent or procedural hazards.

TI assumes no liability for applications assistance or customer product design. TI does not warrant or represent that any license, either express or implied, is granted under any patent right, copyright, mask work right, or other intellectual property right of TI covering or relating to any combination, machine, or process in which such semiconductor products or services might be or are used. TI's publication of information regarding any third party's products or services does not constitute TI's approval, warranty or endorsement thereof.