

FEATURES

- Very Low Dropout Voltage, Less Than 0.6 V at 750 mA
- Low Quiescent Current
- TTL- and CMOS-Compatible Enable on TL751M Series
- 60-V Load-Dump Protection
- Overvoltage Protection
- Internal Thermal-Overload Protection
- Internal Overcurrent-Limiting Circuitry

TL750M...KC PACKAGE⁽¹⁾
(TOP VIEW)

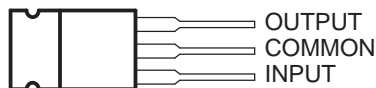

TL750M...KTP PACKAGE⁽¹⁾
(TOP VIEW)

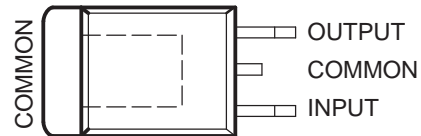

TL750M...KTE PACKAGE⁽¹⁾
(TOP VIEW)

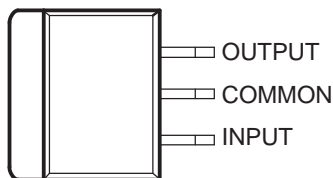

TL750M...KTT PACKAGE⁽¹⁾
(TOP VIEW)

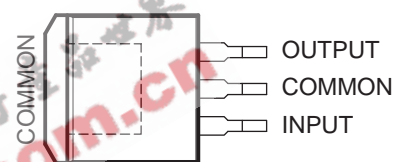

TL751M...KTG PACKAGE⁽¹⁾
(TOP VIEW)

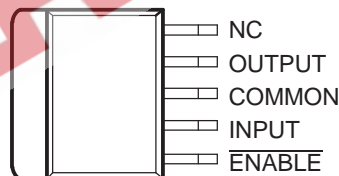

NC - No internal connection

(1) The common terminal is in electrical contact with the mounting base.

DESCRIPTION/ORDERING INFORMATION

The TL750M and TL751M series are low-dropout positive voltage regulators specifically designed for battery-powered systems. The TL750M and TL751M series incorporate onboard overvoltage and current-limiting protection circuitry to protect the devices and the regulated system. Both series are fully protected against 60-V load-dump and reverse-battery conditions. Extremely low quiescent current, even during full-load conditions, makes the TL750M and TL751M series ideal for standby power systems.

The TL750M and TL751M series offers 5-V, 8-V, 10-V, and 12-V options. The TL751M series has the addition of an enable ($\overline{\text{ENABLE}}$) input. The $\overline{\text{ENABLE}}$ input gives the designer complete control over power up, allowing sequential power up or emergency shutdown. When $\overline{\text{ENABLE}}$ is high, the regulator output is placed in the high-impedance state. The $\overline{\text{ENABLE}}$ input is TTL and CMOS compatible.

The TL750MxxC and TL751MxxC are characterized for operation over the virtual junction temperature range 0°C to 125°C.



Please be aware that an important notice concerning availability, standard warranty, and use in critical applications of Texas Instruments semiconductor products and disclaimers thereto appears at the end of this data sheet.

PowerFLEX is a trademark of Texas Instruments.

TL750M SERIES, TL751M SERIES LOW-DROPOUT VOLTAGE REGULATORS

SLVS021K – JANUARY 1988 – REVISED OCTOBER 2006

ORDERING INFORMATION

T _J	V _O TYP	PACKAGE ⁽¹⁾		ORDERABLE PART NUMBER ⁽²⁾	TOP-SIDE MARKING
0°C to 125°C	5 V	PowerFLEX™ – KTE	Reel of 2000	TL750M05CKTER	TL750M05C
		PowerFLEX – KTG	Reel of 2000	TL751M05CKTGR	TL751M05C
		PowerFLEX – KTP	Reel of 3000	TL750M05CKTPR	750M05C
		TO-220 – KC	Tube of 50	TL750M05CKC	TL750M05C
		TO-263 – KTT	Reel of 500	TL750M05CKTTR	TL750M05C
	10 V	TO-220 – KC	Tube of 50	TL750M10CKC	TL750M10C
	12 V	TO-220 – KC	Tube of 50	TL750M12CKC	TL750M12C

- (1) Package drawings, standard packing quantities, thermal data, symbolization, and PCB design guidelines are available at www.ti.com/sc/package.
- (2) For the most current ordering information, see the Package Option Addendum at the end of this data sheet.

TL751Mxx FUNCTIONAL BLOCK DIAGRAM

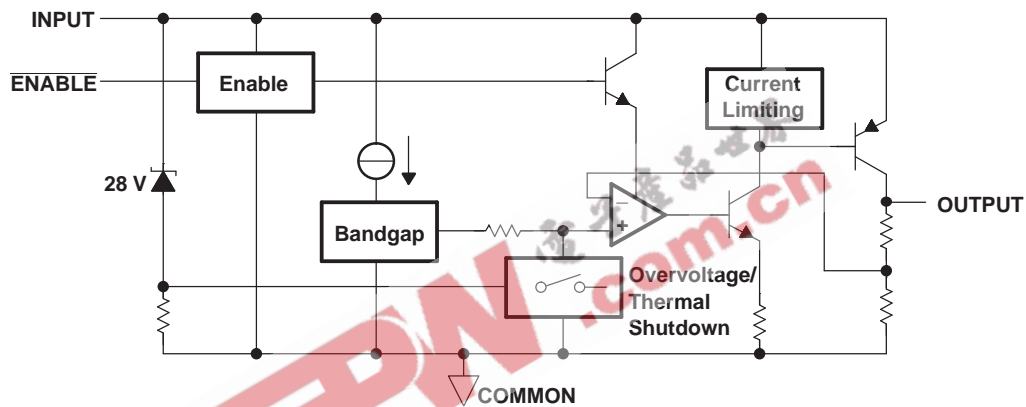

DEVICE COMPONENT COUNT	
Transistors	46
Diodes	14
Resistors	44
Capacitors	4
JFETs	1
Tunnels (emitter R)	2

Absolute Maximum Ratings⁽¹⁾

over virtual junction temperature range (unless otherwise noted)

		MIN	MAX	UNIT
	Continuous input voltage		26	V
	Transient input voltage (see Figure 3)		60	V
	Continuous reverse input voltage		-15	V
	Transient reverse input voltage	t = 100 ms	-50	V
θ_{JA}	Package thermal impedance ⁽²⁾⁽³⁾	KC package	22	°C/W
		KTE package	23	
		KTG package	23	
		KTP package	28	
		KTT package	25.3	
T_J	Virtual junction temperature range	0	150	°C
	Lead temperature	1,6 mm (1/16 in) from case for 10 s	260	°C
T_{stg}	Storage temperature range	-65	150	°C

- Stresses beyond those listed under "absolute maximum ratings" may cause permanent damage to the device. These are stress ratings only, and functional operation of the device at these or any other conditions beyond those indicated under "recommended operating conditions" is not implied. Exposure to absolute-maximum-rated conditions for extended periods may affect device reliability.
- Maximum power dissipation is a function of $T_J(\text{max})$, θ_{JA} , and T_A . The maximum allowable power dissipation at any allowable ambient temperature is $P_D = (T_J(\text{max}) - T_A)/\theta_{JA}$. Operating at the absolute maximum T_J of 150°C can affect reliability. Due to variation in individual device electrical characteristics and thermal resistance, the built-in thermal-overload protection may be activated at power levels slightly above or below the rated dissipation.
- The package thermal impedance is calculated in accordance with JESD 51.

Recommended Operating Conditions

		MIN	MAX	UNIT	
V_I	Input voltage	TL75xM05	6	26	V
		TL75xM08	9	26	
		TL75xM10	11	26	
		TL75xM12	13	26	
V_{IH}	High-level $\overline{\text{ENABLE}}$ input voltage	TL751Mxx	2	15	V
V_{IL}	Low-level $\overline{\text{ENABLE}}$ input voltage	TL751Mxx	0	0.8	V
I_O	Output current	TL75xMxxC		750	mA
T_J	Operating virtual junction temperature	TL75xMxxC	0	125	°C

TL751MxxC Switching Characteristics

$V_I = 14\text{ V}$, $I_O = 300\text{ mA}$, $T_J = 25^\circ\text{C}$ (unless otherwise noted)

PARAMETER	TL751MxxC	UNIT
	TYP	
t_r Response time, $\overline{\text{ENABLE}}$ to output	50	μs

TL750M SERIES, TL751M SERIES LOW-DROPOUT VOLTAGE REGULATORS

SLVS021K–JANUARY 1988–REVISED OCTOBER 2006

TL75xM05C Electrical Characteristics⁽¹⁾

$V_I = 14\text{ V}$, $I_O = 300\text{ mA}$, $\overline{\text{ENABLE}} = 0\text{ V}$ for TL751M05, $T_J = 25^\circ\text{C}$ (unless otherwise noted)

PARAMETER	TEST CONDITIONS	TL750M05C TL751M05C			UNIT
		MIN	TYP	MAX	
Output voltage		4.95	5	5.05	V
	$T_J = 0^\circ\text{C}$ to 125°C	4.9		5.1	
Input voltage regulation	$V_I = 9\text{ V}$ to 16 V , $I_O = 250\text{ mA}$		10	25	mV
	$V_I = 6\text{ V}$ to 26 V , $I_O = 250\text{ mA}$		12	50	
Ripple rejection	$V_I = 8\text{ V}$ to 18 V , $f = 120\text{ Hz}$	50	55		dB
Output regulation voltage	$I_O = 5\text{ mA}$ to 750 mA		20	50	mV
Dropout voltage	$I_O = 500\text{ mA}$			0.5	V
	$I_O = 750\text{ mA}$			0.6	
Output noise voltage	$f = 10\text{ Hz}$ to 100 kHz		500		μV
Bias current	$I_O = 750\text{ mA}$		60	75	mA
	$I_O = 10\text{ mA}$			5	
Bias current (TL751Mxx only)	$\overline{\text{ENABLE}} \geq 2\text{ V}$			200	μA

(1) Pulse-testing techniques maintain the junction temperature as close to the ambient temperature as possible. Thermal effects must be taken into account separately. All characteristics are measured with a $0.1\text{-}\mu\text{F}$ capacitor across the input and a $10\text{-}\mu\text{F}$ tantalum capacitor on the output, with equivalent series resistance within the guidelines shown in Figure 1.

TL75xM08C Electrical Characteristics⁽¹⁾

$V_I = 14\text{ V}$, $I_O = 300\text{ mA}$, $\overline{\text{ENABLE}} = 0\text{ V}$ for TL751M08, $T_J = 25^\circ\text{C}$ (unless otherwise noted)

PARAMETER	TEST CONDITIONS	TL750M08C TL751M08C			UNIT
		MIN	TYP	MAX	
Output voltage		7.92	8	8.08	V
	$T_J = 0^\circ\text{C}$ to 125°C	7.84		8.16	
Input voltage regulation	$V_I = 10\text{ V}$ to 17 V , $I_O = 250\text{ mA}$		12	40	mV
	$V_I = 9\text{ V}$ to 26 V , $I_O = 250\text{ mA}$		15	68	
Ripple rejection	$V_I = 11\text{ V}$ to 21 V , $f = 120\text{ Hz}$	50	55		dB
Output regulation voltage	$I_O = 5\text{ mA}$ to 750 mA		24	80	mV
Dropout voltage	$I_O = 500\text{ mA}$			0.5	V
	$I_O = 750\text{ mA}$			0.6	
Output noise voltage	$f = 10\text{ Hz}$ to 100 kHz		500		μV
Bias current	$I_O = 750\text{ mA}$		60	75	mA
	$I_O = 10\text{ mA}$			5	
Bias current (TL751Mxx only)	$\overline{\text{ENABLE}} \geq 2\text{ V}$			200	μA

(1) Pulse-testing techniques maintain the junction temperature as close to the ambient temperature as possible. Thermal effects must be taken into account separately. All characteristics are measured with a $0.1\text{-}\mu\text{F}$ capacitor across the input and a $10\text{-}\mu\text{F}$ tantalum capacitor on the output, with equivalent series resistance within the guidelines shown in Figure 1.

TL75xM10C Electrical Characteristics⁽¹⁾

$V_I = 14\text{ V}$, $I_O = 300\text{ mA}$, $\overline{\text{ENABLE}} = 0\text{ V}$ for TL751M10, $T_J = 25^\circ\text{C}$ (unless otherwise noted)

PARAMETER	TEST CONDITIONS	TL750M10C TL751M10C			UNIT
		MIN	TYP	MAX	
Output voltage		9.9	10	10.1	V
	$T_J = 0^\circ\text{C to } 125^\circ\text{C}$	9.8		10.2	
Input voltage regulation	$V_I = 12\text{ V to } 18\text{ V}$, $I_O = 250\text{ mA}$		15	43	mV
	$V_I = 11\text{ V to } 26\text{ V}$, $I_O = 250\text{ mA}$		20	75	
Ripple rejection	$V_I = 13\text{ V to } 23\text{ V}$, $f = 120\text{ Hz}$	50	55		dB
Output regulation voltage	$I_O = 5\text{ mA to } 750\text{ mA}$		30	100	mV
Dropout voltage	$I_O = 500\text{ mA}$			0.5	V
	$I_O = 750\text{ mA}$			0.6	
Output noise voltage	$f = 10\text{ Hz to } 100\text{ kHz}$		1000		μV
Bias current	$I_O = 750\text{ mA}$		60	75	mA
	$I_O = 10\text{ mA}$			5	
Bias current (TL751Mxx only)	$\overline{\text{ENABLE}} \geq 2\text{ V}$			200	μA

(1) Pulse-testing techniques maintain the junction temperature as close to the ambient temperature as possible. Thermal effects must be taken into account separately. All characteristics are measured with a $0.1\text{-}\mu\text{F}$ capacitor across the input and a $10\text{-}\mu\text{F}$ tantalum capacitor on the output, with equivalent series resistance within the guidelines shown in Figure 1.

TL75xM12C Electrical Characteristics⁽¹⁾

$V_I = 14\text{ V}$, $I_O = 300\text{ mA}$, $\overline{\text{ENABLE}} = 0\text{ V}$ for TL751M12, $T_J = 25^\circ\text{C}$ (unless otherwise noted)

PARAMETER	TEST CONDITIONS	TL750M12C TL751M12C			UNIT
		MIN	TYP	MAX	
Output voltage		11.88	12	12.12	V
	$T_J = 0^\circ\text{C to } 125^\circ\text{C}$	11.76		12.24	
Input voltage regulation	$V_I = 14\text{ V to } 19\text{ V}$, $I_O = 250\text{ mA}$		15	43	mV
	$V_I = 13\text{ V to } 26\text{ V}$, $I_O = 250\text{ mA}$		20	78	
Ripple rejection	$V_I = 13\text{ V to } 23\text{ V}$, $f = 120\text{ Hz}$	50	55		dB
Output regulation voltage	$I_O = 5\text{ mA to } 750\text{ mA}$		30	120	mV
Dropout voltage	$I_O = 500\text{ mA}$			0.5	V
	$I_O = 750\text{ mA}$			0.6	
Output noise voltage	$f = 10\text{ Hz to } 100\text{ kHz}$		1000		μV
Bias current	$I_O = 750\text{ mA}$		60	75	mA
	$I_O = 10\text{ mA}$			5	
Bias current (TL751Mxx only)	$\overline{\text{ENABLE}} \geq 2\text{ V}$			200	μA

(1) Pulse-testing techniques maintain the junction temperature as close to the ambient temperature as possible. Thermal effects must be taken into account separately. All characteristics are measured with a $0.1\text{-}\mu\text{F}$ capacitor across the input and a $10\text{-}\mu\text{F}$ tantalum capacitor on the output, with equivalent series resistance within the guidelines shown in Figure 1.

PARAMETER MEASUREMENT INFORMATION

The TL750Mxx is a low-dropout regulator. This means that the capacitance loading is important to the performance of the regulator because it is a vital part of the control loop. The capacitor value and the equivalent series resistance (ESR) both affect the control loop and must be defined for the load range and the temperature range. Figure 1 and Figure 2 can establish the capacitance value and ESR range for the best regulator performance.

Figure 1 shows the recommended range of ESR for a given load with a 10-μF capacitor on the output. This figure also shows a maximum ESR limit of 2 Ω and a load-dependent minimum ESR limit.

For applications with varying loads, the lightest load condition should be chosen because it is the worst case. Figure 2 shows the relationship of the reciprocal of ESR to the square root of the capacitance with a minimum capacitance limit of 10 μF and a maximum ESR limit of 2 Ω. This figure establishes the amount that the minimum ESR limit shown in Figure 1 can be adjusted for different capacitor values.

For example, where the minimum load needed is 200 mA, Figure 1 suggests an ESR range of 0.8 Ω to 2 Ω for 10 μF. Figure 2 shows that changing the capacitor from 10 μF to 400 μF can change the ESR minimum by greater than 3/0.5 (or 6). Therefore, the new minimum ESR value is 0.8/6 (or 0.13 Ω). This allows an ESR range of 0.13 Ω to 2 Ω, achieving an expanded ESR range by using a larger capacitor at the output. For better stability in low-current applications, a small resistance placed in series with the capacitor (see Table 1) is recommended, so that ESRs better approximate those shown in Figure 1 and Figure 2.

Table 1. Compensation for Increased Stability at Low Currents

MANUFACTURER	CAPACITANCE	ESR TYP	PART NUMBER	ADDITIONAL RESISTANCE
AVX	15 μF	0.9 Ω	TAJB156M010S	1 Ω
KEMET	33 μF	0.6 Ω	T491D336M010AS	0.5 Ω

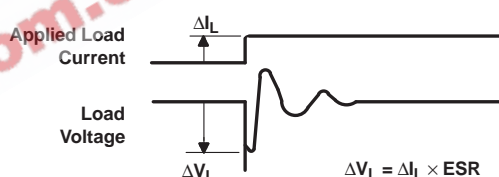

OUTPUT CAPACITOR
EQUIVALENT SERIES RESISTANCE (ESR)
vs
LOAD CURRENT RANGE

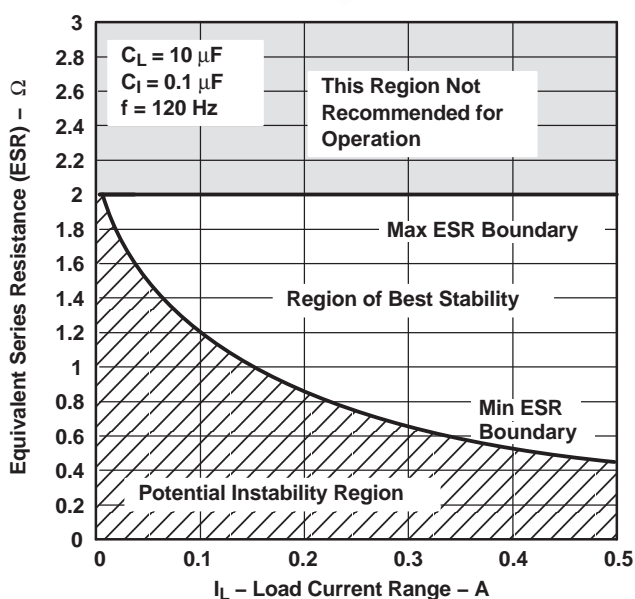

Figure 1.

STABILITY
vs
EQUIVALENT SERIES RESISTANCE (ESR)

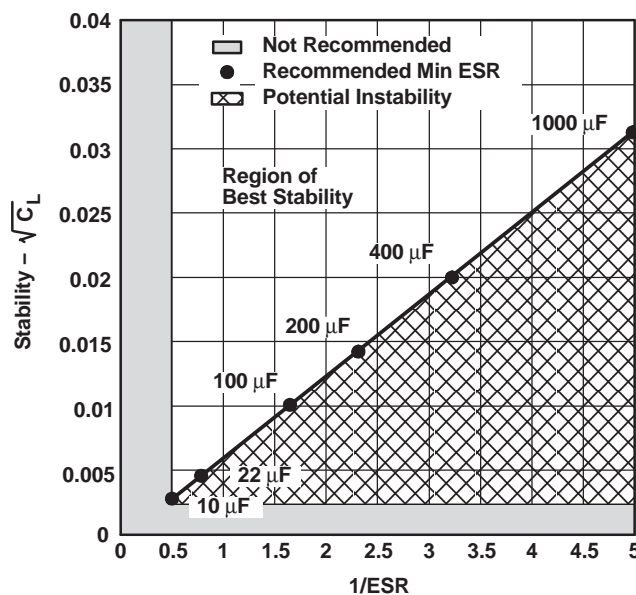

Figure 2.

TYPICAL CHARACTERISTICS

Table of Graphs

		FIGURE
Transient input voltage vs Time		3
Output voltage vs Input voltage		4
Input current vs Input voltage	$I_O = 10 \text{ mA}$	5
	$I_O = 100 \text{ mA}$	6
Dropout voltage vs Output current		7
Quiescent voltage vs Output current		8
Load transient response		9
Line transient response		10

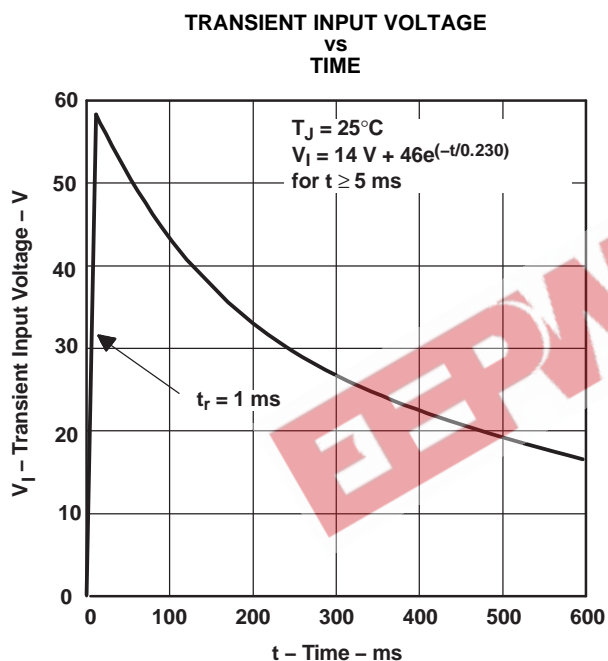

Figure 3.

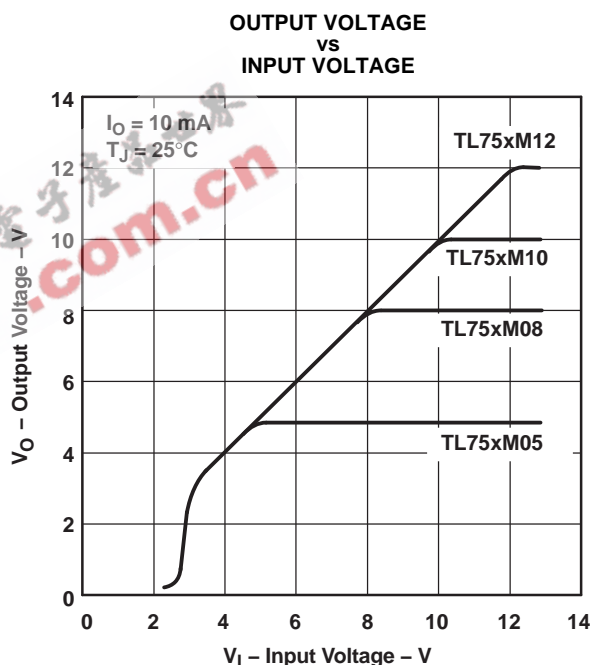
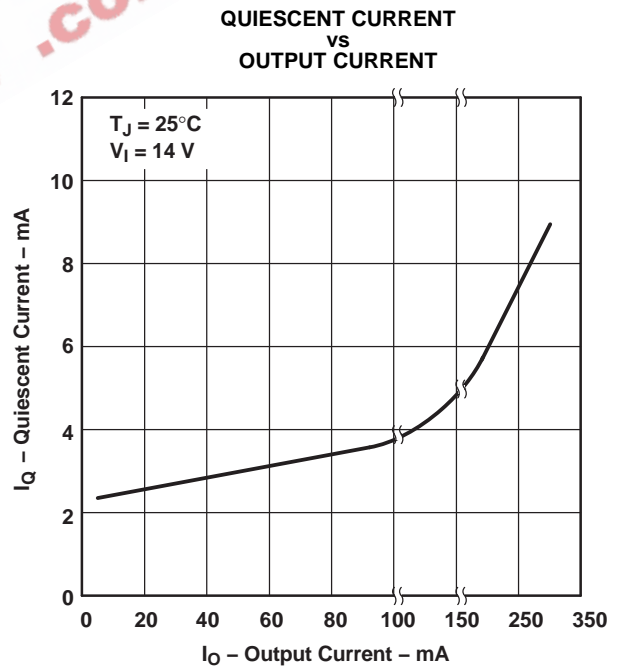
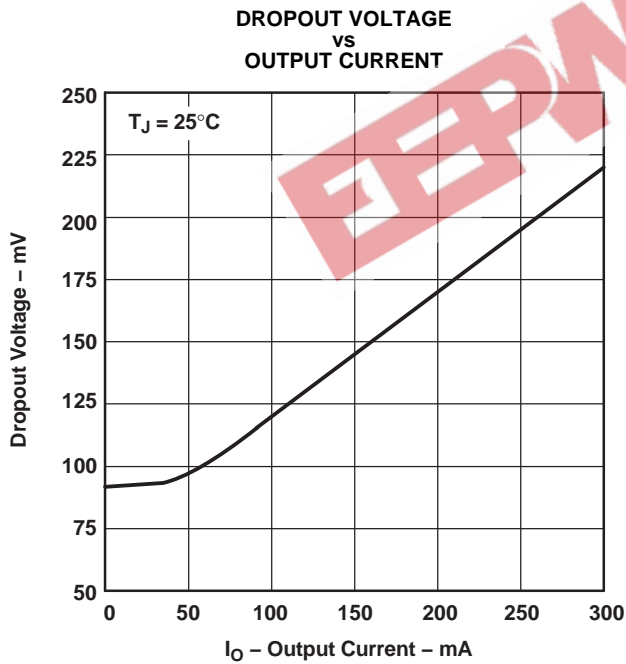
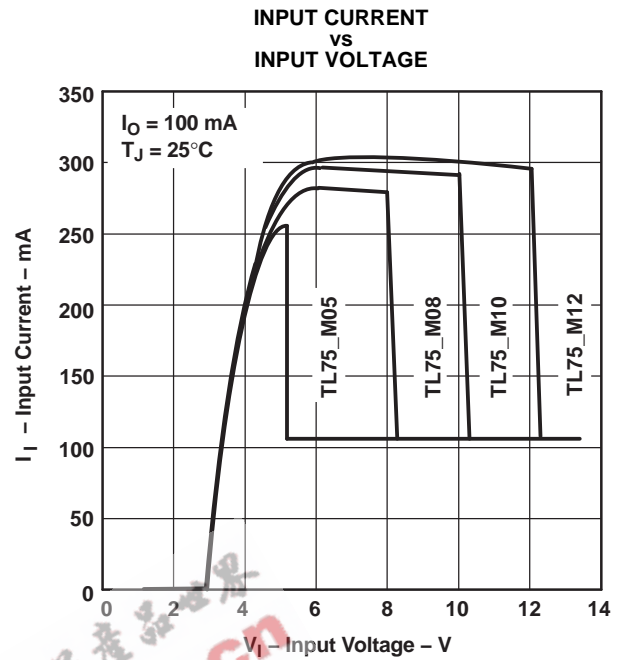
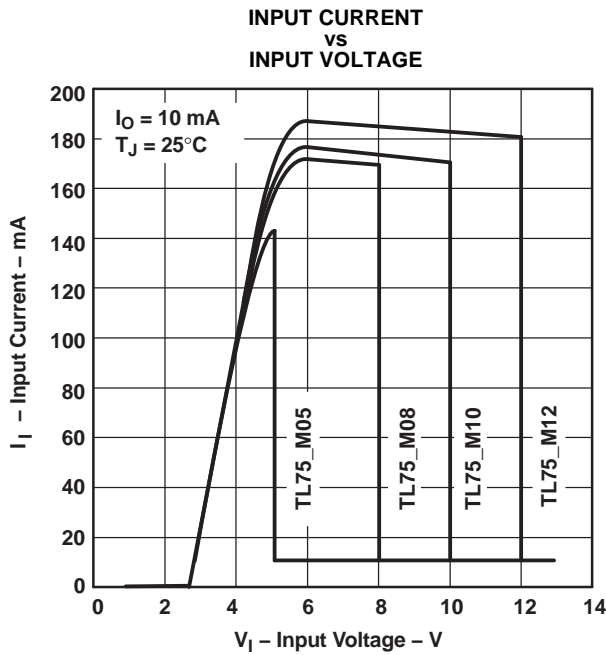

Figure 4.

TL750M SERIES, TL751M SERIES LOW-DROPOUT VOLTAGE REGULATORS

SLVS021K – JANUARY 1988 – REVISED OCTOBER 2006



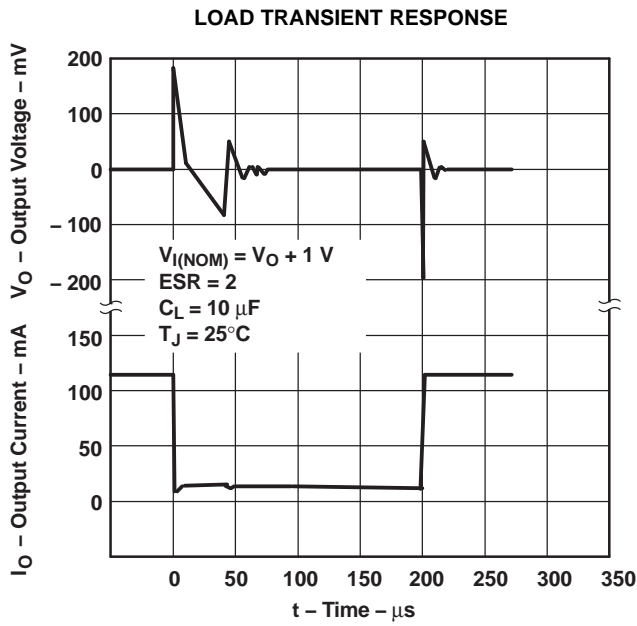

Figure 9.

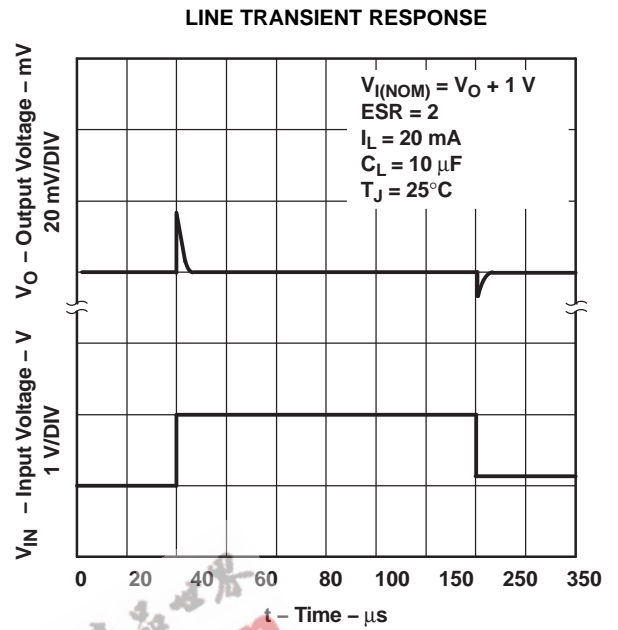

Figure 10.

EEPW.com.cn 电子产品世界

PACKAGING INFORMATION

Orderable Device	Status ⁽¹⁾	Package Type	Package Drawing	Pins	Package Qty	Eco Plan ⁽²⁾	Lead/Ball Finish	MSL Peak Temp ⁽³⁾
TL750M05CKC	NRND	TO-220	KC	3	50	Pb-Free (RoHS)	CU SN	N / A for Pkg Type
TL750M05CKCE3	NRND	TO-220	KC	3	50	Pb-Free (RoHS)	CU SN	N / A for Pkg Type
TL750M05CKCSE3	ACTIVE	TO-220	KCS	3	50	Pb-Free (RoHS)	CU SN	N / A for Pkg Type
TL750M05CKTER	NRND	PFM	KTE	3	2000	TBD	CU SNPB	Level-1-220C-UNLIM
TL750M05CKTPR	NRND	PFM	KTP	2	3000	Green (RoHS & no Sb/Br)	CU SN	Level-1-260C-UNLIM
TL750M05CKTPRG3	NRND	PFM	KTP	2	3000	Green (RoHS & no Sb/Br)	CU SN	Level-1-260C-UNLIM
TL750M05CKTTR	ACTIVE	DDPAK/ TO-263	KTT	3	500	Green (RoHS & no Sb/Br)	CU SN	Level-3-245C-168 HR
TL750M05CKTTRG3	ACTIVE	DDPAK/ TO-263	KTT	3	500	Green (RoHS & no Sb/Br)	CU SN	Level-3-245C-168 HR
TL750M05CKVURG3	ACTIVE	PFM	KVU	3	2500	Green (RoHS & no Sb/Br)	CU SN	Level-3-260C-168 HR
TL750M08CKCE3	NRND	TO-220	KC	3	50	Pb-Free (RoHS)	CU SN	N / A for Pkg Type
TL750M08CKCSE3	ACTIVE	TO-220	KCS	3	50	Pb-Free (RoHS)	CU SN	N / A for Pkg Type
TL750M08CKTPRG3	NRND	PFM	KTP	2	3000	Green (RoHS & no Sb/Br)	CU SN	Level-1-260C-UNLIM
TL750M08CKVURG3	ACTIVE	PFM	KVU	3	2500	Green (RoHS & no Sb/Br)	CU SN	Level-3-260C-168 HR
TL750M10CKC	NRND	TO-220	KC	3	50	Pb-Free (RoHS)	CU SN	N / A for Pkg Type
TL750M10CKCE3	NRND	TO-220	KC	3	50	Pb-Free (RoHS)	CU SN	N / A for Pkg Type
TL750M10CKCSE3	ACTIVE	TO-220	KCS	3	50	Pb-Free (RoHS)	CU SN	N / A for Pkg Type
TL750M10CKTER	NRND	PFM	KTE	3	2000	TBD	CU SNPB	Level-1-220C-UNLIM
TL750M10CKTPR	NRND	PFM	KTP	2	3000	Green (RoHS & no Sb/Br)	CU SN	Level-1-260C-UNLIM
TL750M10CKTPRG3	NRND	PFM	KTP	2	3000	Green (RoHS & no Sb/Br)	CU SN	Level-1-260C-UNLIM
TL750M10CKVURG3	ACTIVE	PFM	KVU	3	2500	Green (RoHS & no Sb/Br)	CU SN	Level-3-260C-168 HR
TL750M12CKC	NRND	TO-220	KC	3	50	Pb-Free (RoHS)	CU SN	N / A for Pkg Type
TL750M12CKCE3	NRND	TO-220	KC	3	50	Pb-Free (RoHS)	CU SN	N / A for Pkg Type
TL750M12CKCSE3	ACTIVE	TO-220	KCS	3	50	Pb-Free (RoHS)	CU SN	N / A for Pkg Type
TL750M12CKTPRG3	NRND	PFM	KTP	2	3000	Green (RoHS & no Sb/Br)	CU SN	Level-1-260C-UNLIM
TL750M12CKVURG3	ACTIVE	PFM	KVU	3	2500	Green (RoHS & no Sb/Br)	CU SN	Level-3-260C-168 HR
TL751M05CKTGR	OBSOLETE	PFM	KTG	5		TBD	Call TI	Call TI

(1) The marketing status values are defined as follows:

ACTIVE: Product device recommended for new designs.

LIFEBUY: TI has announced that the device will be discontinued, and a lifetime-buy period is in effect.

NRND: Not recommended for new designs. Device is in production to support existing customers, but TI does not recommend using this part in a new design.

PREVIEW: Device has been announced but is not in production. Samples may or may not be available.

OBSOLETE: TI has discontinued the production of the device.

(2) Eco Plan - The planned eco-friendly classification: Pb-Free (RoHS), Pb-Free (RoHS Exempt), or Green (RoHS & no Sb/Br) - please check <http://www.ti.com/productcontent> for the latest availability information and additional product content details.

TBD: The Pb-Free/Green conversion plan has not been defined.

Pb-Free (RoHS): TI's terms "Lead-Free" or "Pb-Free" mean semiconductor products that are compatible with the current RoHS requirements for all 6 substances, including the requirement that lead not exceed 0.1% by weight in homogeneous materials. Where designed to be soldered at high temperatures, TI Pb-Free products are suitable for use in specified lead-free processes.

Pb-Free (RoHS Exempt): This component has a RoHS exemption for either 1) lead-based flip-chip solder bumps used between the die and package, or 2) lead-based die adhesive used between the die and leadframe. The component is otherwise considered Pb-Free (RoHS compatible) as defined above.

Green (RoHS & no Sb/Br): TI defines "Green" to mean Pb-Free (RoHS compatible), and free of Bromine (Br) and Antimony (Sb) based flame retardants (Br or Sb do not exceed 0.1% by weight in homogeneous material)

(3) MSL, Peak Temp. -- The Moisture Sensitivity Level rating according to the JEDEC industry standard classifications, and peak solder temperature.

Important Information and Disclaimer: The information provided on this page represents TI's knowledge and belief as of the date that it is provided. TI bases its knowledge and belief on information provided by third parties, and makes no representation or warranty as to the accuracy of such information. Efforts are underway to better integrate information from third parties. TI has taken and continues to take reasonable steps to provide representative and accurate information but may not have conducted destructive testing or chemical analysis on incoming materials and chemicals. TI and TI suppliers consider certain information to be proprietary, and thus CAS numbers and other limited information may not be available for release.

In no event shall TI's liability arising out of such information exceed the total purchase price of the TI part(s) at issue in this document sold by TI to Customer on an annual basis.

MECHANICAL DATA

MPFM001E – OCTOBER 1994 – REVISED JANUARY 2001

KTE (R-PSFM-G3)

PowerFLEX™ PLASTIC FLANGE-MOUNT

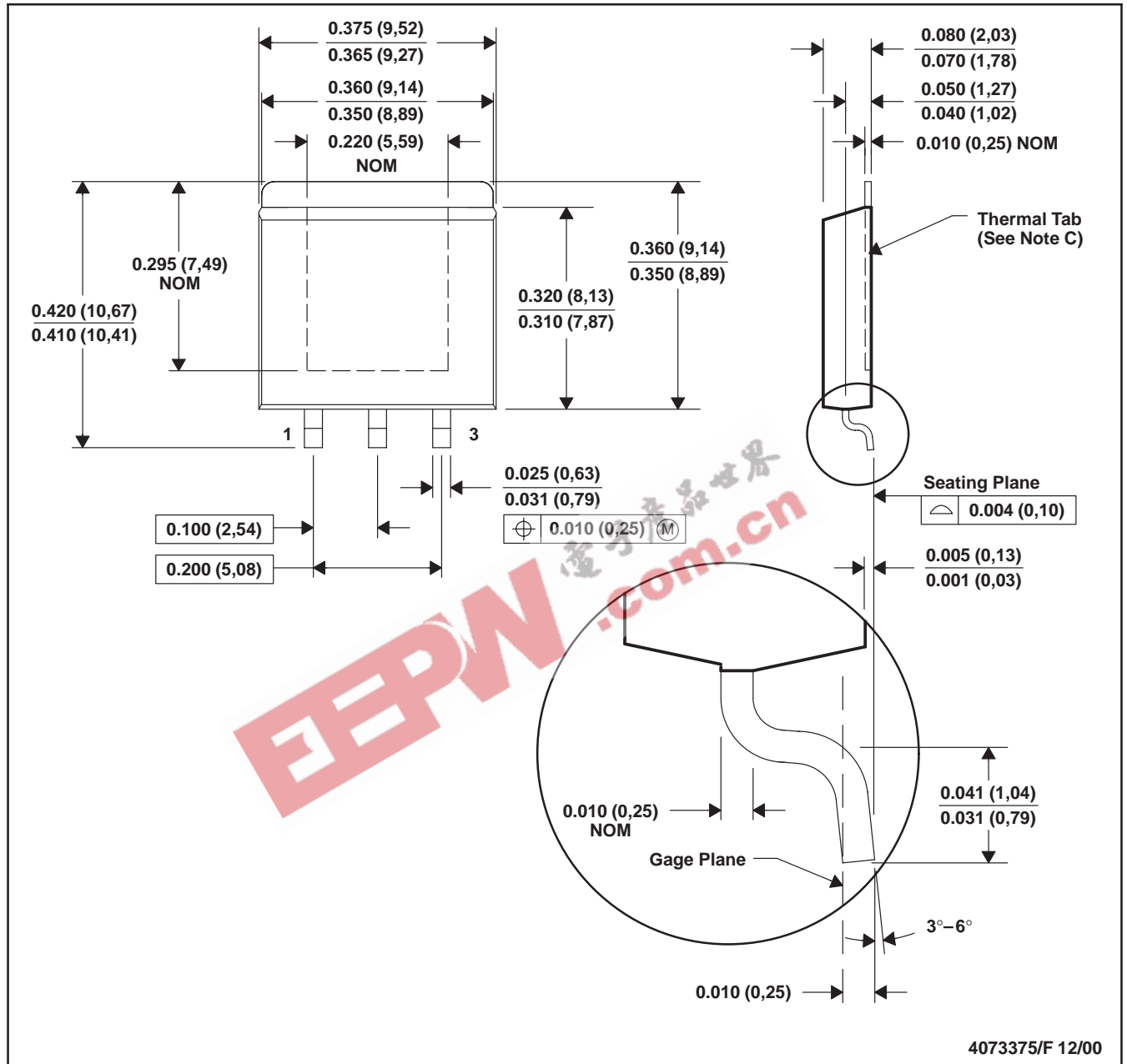

- NOTES:
- All linear dimensions are in inches (millimeters).
 - This drawing is subject to change without notice.
 - The center lead is in electrical contact with the thermal tab.
 - Dimensions do not include mold protrusions, not to exceed 0.006 (0,15).
 - Falls within JEDEC MO-169

PowerFLEX is a trademark of Texas Instruments.

 **TEXAS
INSTRUMENTS**

POST OFFICE BOX 655303 • DALLAS, TEXAS 75265

MECHANICAL DATA

MPPM003F – OCTOBER 1994 – REVISED MARCH 2002

KTG (R-PSFM-G5)

PowerFLEX™ PLASTIC FLANGE-MOUNT PACKAGE

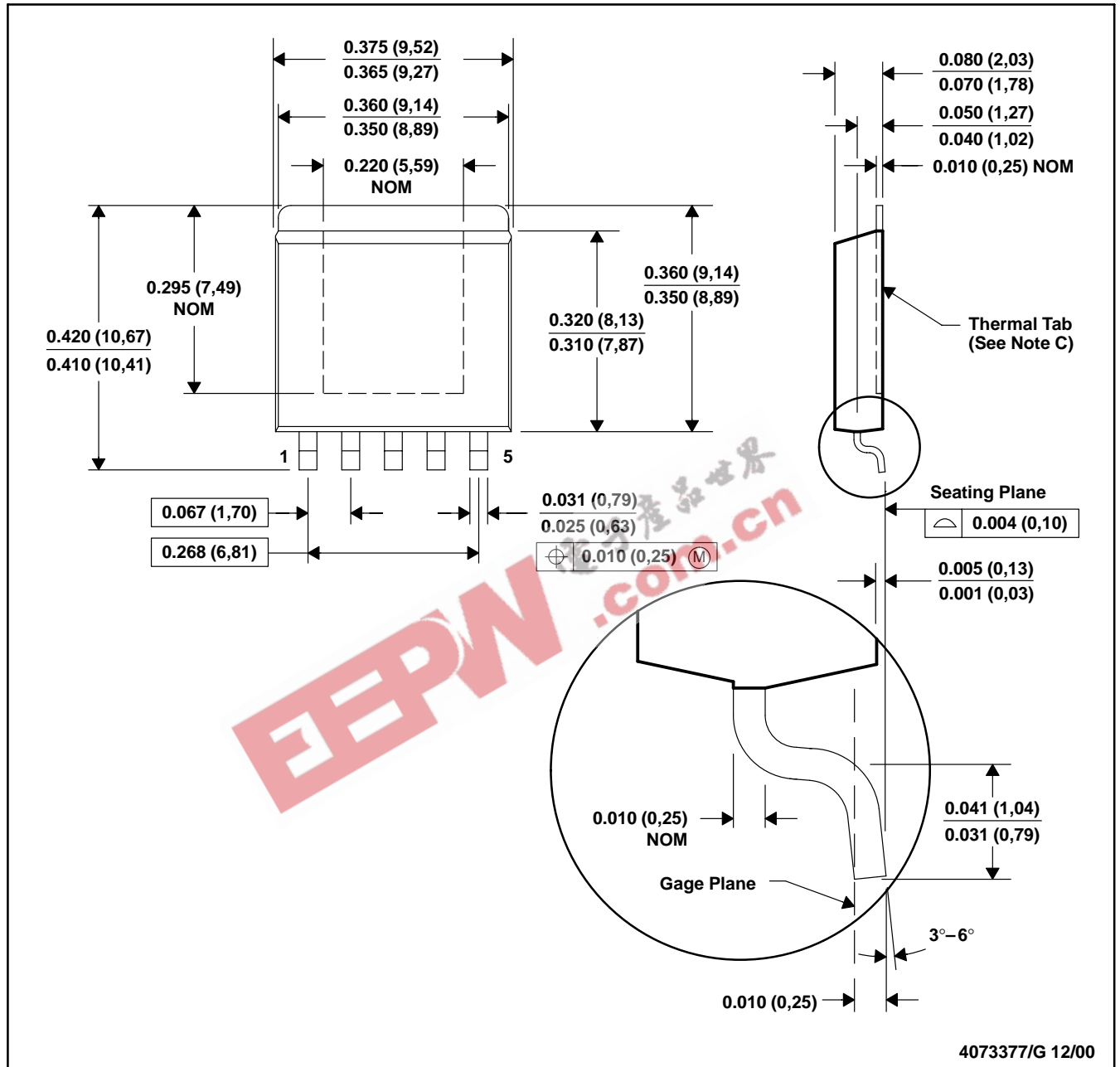

- NOTES:
- All linear dimensions are in inches (millimeters).
 - This drawing is subject to change without notice.
 - The center lead is in electrical contact with the thermal tab.
 - Dimensions do not include mold protrusions, not to exceed 0.006 (0,15).
 - FALLS within JEDEC MO-169

PowerFLEX is a trademark of Texas Instruments.

 **TEXAS
INSTRUMENTS**

POST OFFICE BOX 655303 • DALLAS, TEXAS 75265

KTP (R-PSFM-G2)

PowerFLEX™ PLASTIC FLANGE-MOUNT PACKAGE

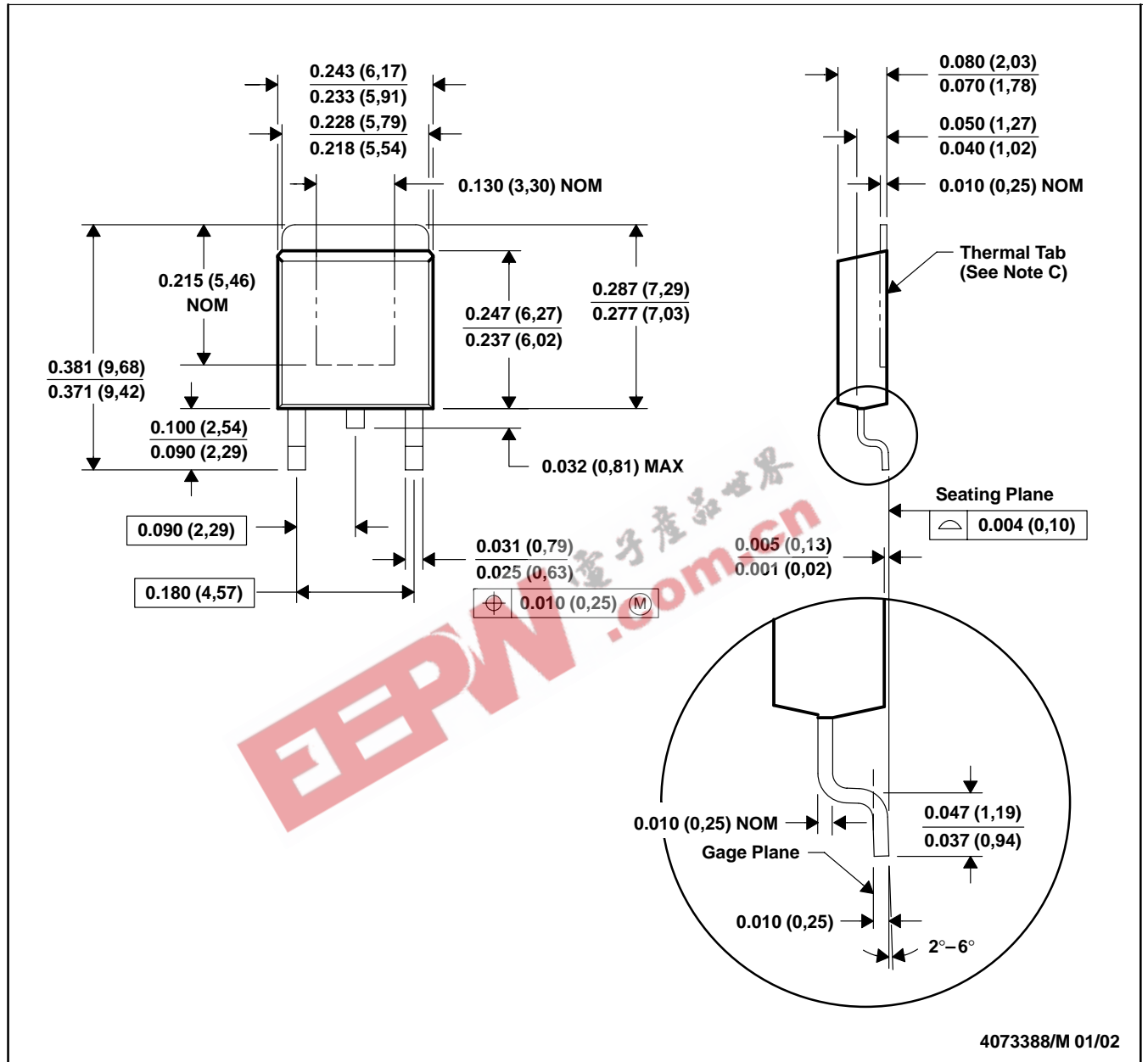

- NOTES: A. All linear dimensions are in inches (millimeters).
 B. This drawing is subject to change without notice.
 C. The center lead is in electrical contact with the thermal tab.
 D. Dimensions do not include mold protrusions, not to exceed 0.006 (0,15).
 E. Falls within JEDEC TO-252 variation AC.

PowerFLEX is a trademark of Texas Instruments.

MECHANICAL DATA

KTT (R-PSFM-G3)

PLASTIC FLANGE-MOUNT PACKAGE

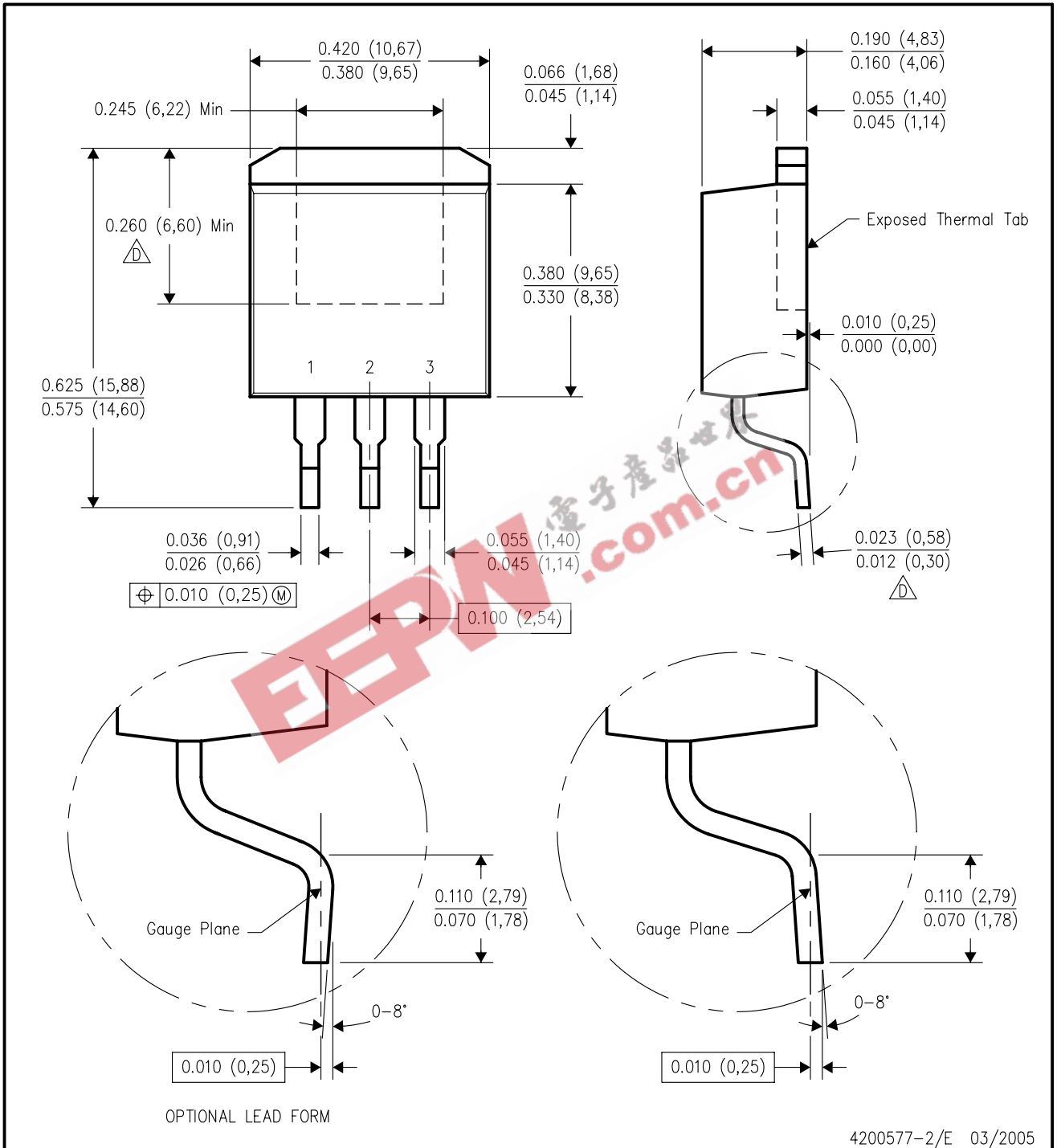

4200577-2/E 03/2005

- NOTES:
- All linear dimensions are in inches (millimeters).
 - This drawing is subject to change without notice.
 - Body dimensions do not include mold flash or protrusion. Mold flash or protrusion not to exceed 0.005 (0,13) per side.
- \triangle Falls within JEDEC TO-263 variation AA, except minimum lead thickness and minimum exposed pad length.

KTT (R-PSFM-G3)

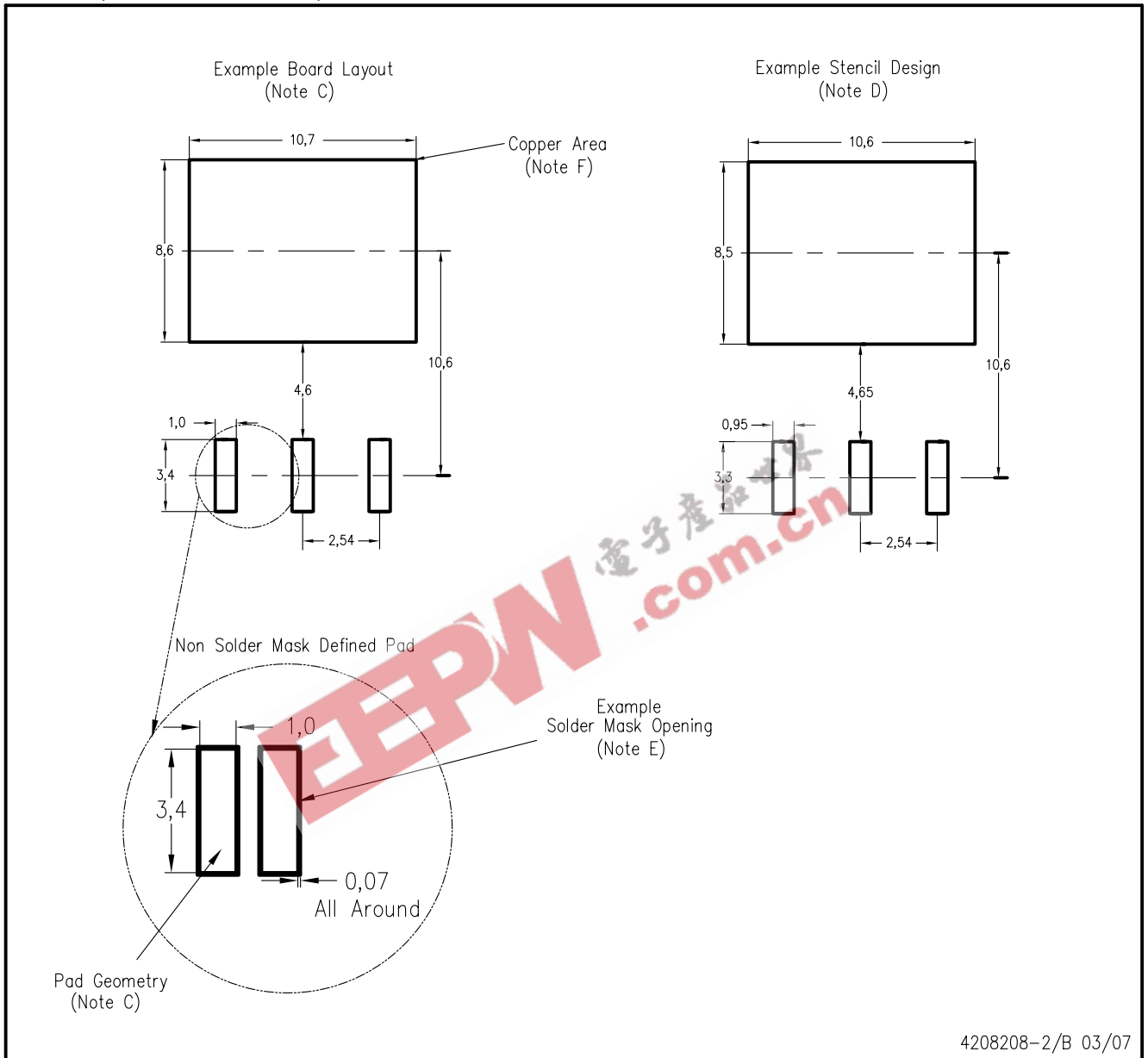

- NOTES:
- A. All linear dimensions are in millimeters.
 - B. This drawing is subject to change without notice.
 - C. Publication IPC-SM-782 is recommended for alternate designs.
 - D. Laser cutting apertures with trapezoidal walls and also rounding corners will offer better paste release. Customers should contact their board assembly site for stencil design recommendations. Refer to IPC-7525.
 - E. Customers should contact their board fabrication site for solder mask tolerances between and around signal pads.
 - F. This package is designed to be soldered to a thermal pad on the board. Refer to the Product Datasheet for specific thermal information, via requirements, and recommended thermal pad size. For thermal pad sizes larger than shown a solder mask defined pad is recommended in order to maintain the solderable pad geometry while increasing copper area.

MECHANICAL DATA

KCS (R-PSFM-T3)

PLASTIC FLANGE-MOUNT PACKAGE

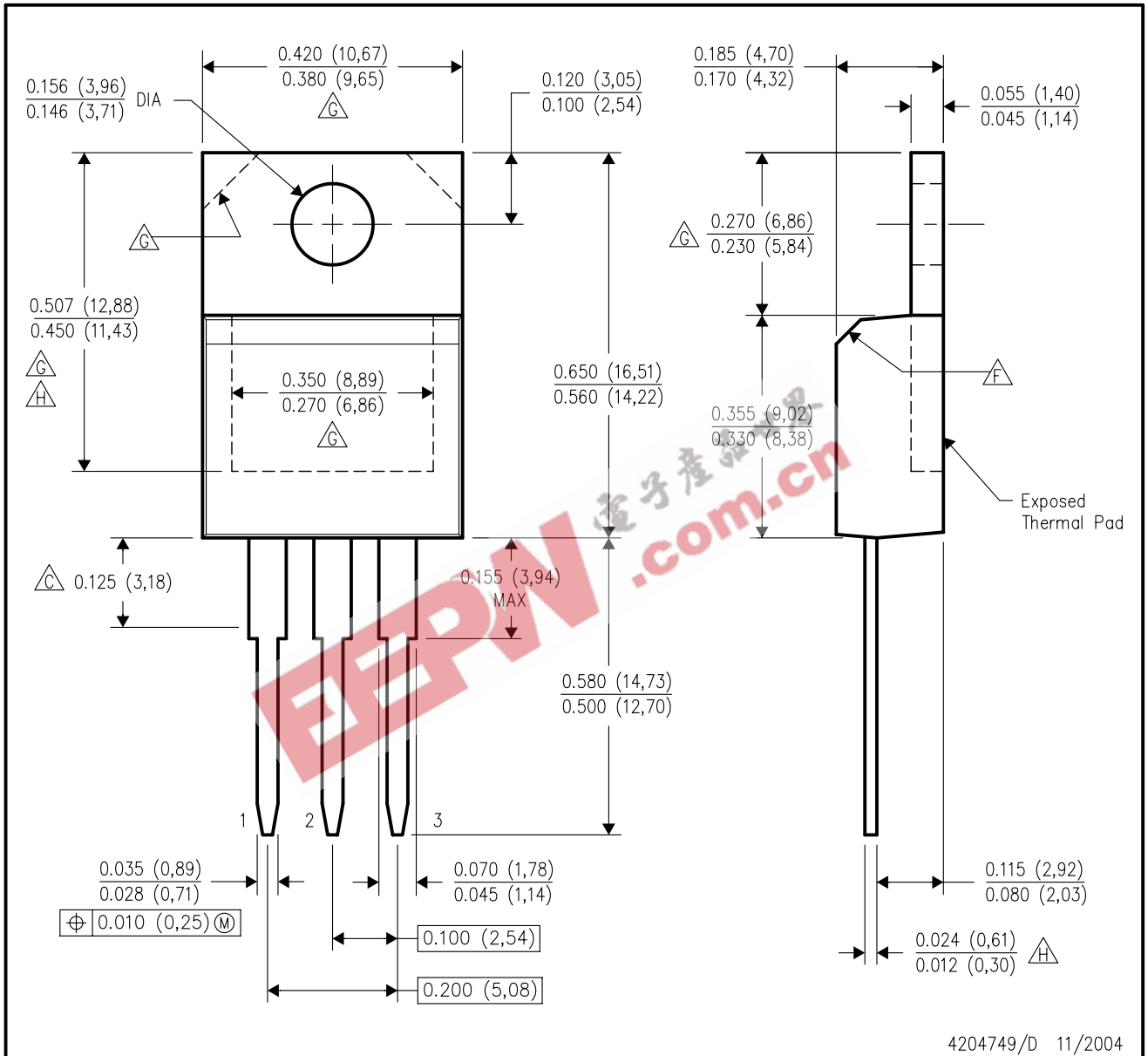

- NOTES:
- A. All linear dimensions are in inches (millimeters).
 - B. This drawing is subject to change without notice.
 - C. Lead dimensions are not controlled within this area.
 - D. All lead dimensions apply before solder dip.
 - E. The center lead is in electrical contact with the mounting tab.
 - F. The chamfer is optional.
 - G. Thermal pad contour optional within these dimensions.
 - H. Falls within JEDEC TO-220 variation AB, except minimum lead thickness and minimum exposed pad length.

MECHANICAL DATA

KVU (R-PSFM-G3)

PLASTIC FLANGE-MOUNT PACKAGE

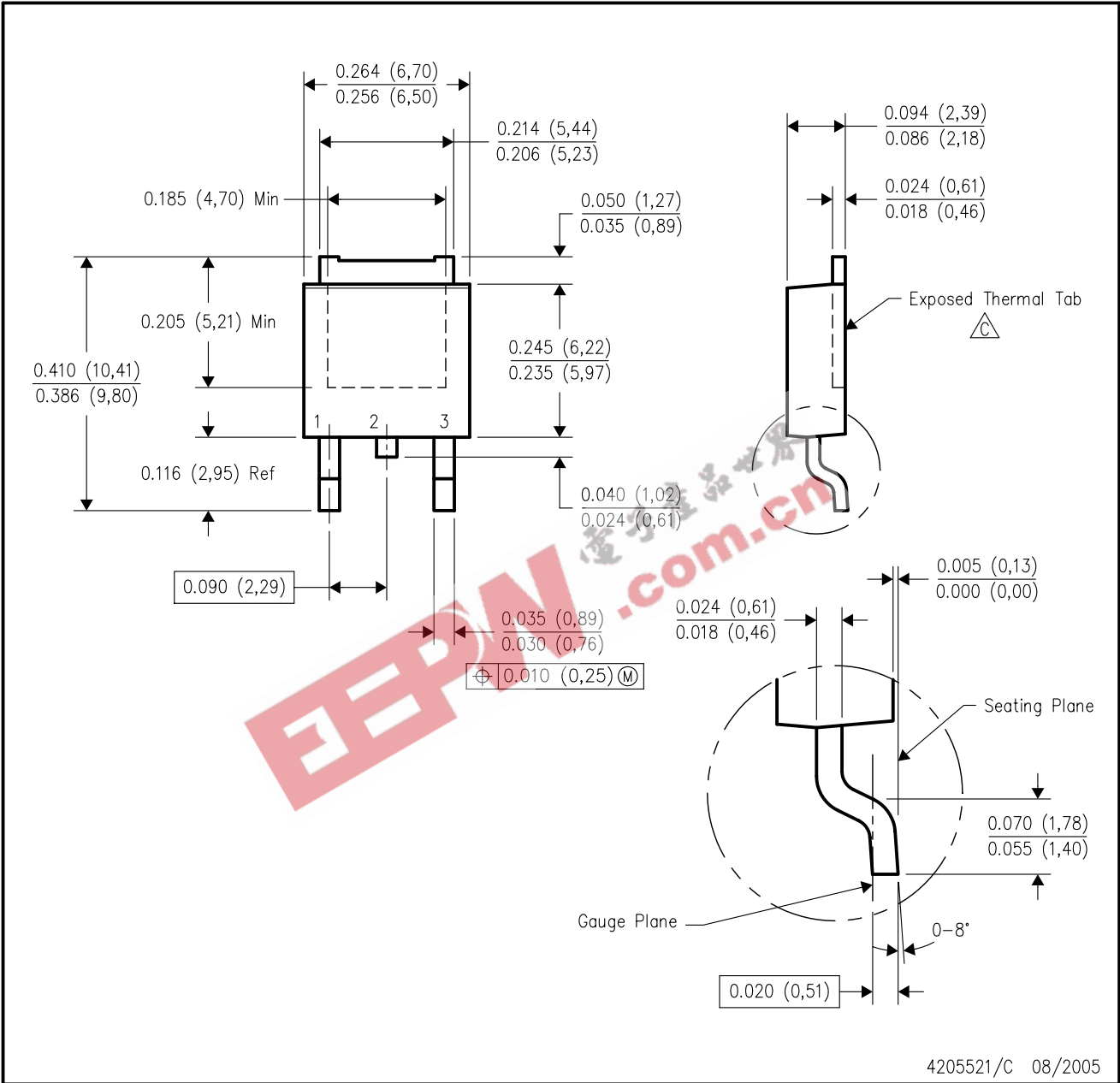

- NOTES:
- A. All linear dimensions are in inches (millimeters).
 - B. This drawing is subject to change without notice.
 - C. The center lead is in electrical contact with the exposed thermal tab.
 - D. Body Dimensions do not include mold flash or protrusions. Mold flash and protrusion shall not exceed 0.006 (0,15) per side.
 - E. Falls within JEDEC TO-252 variation AA.

MECHANICAL DATA

KC (R-PSFM-T3)

PLASTIC FLANGE-MOUNT PACKAGE

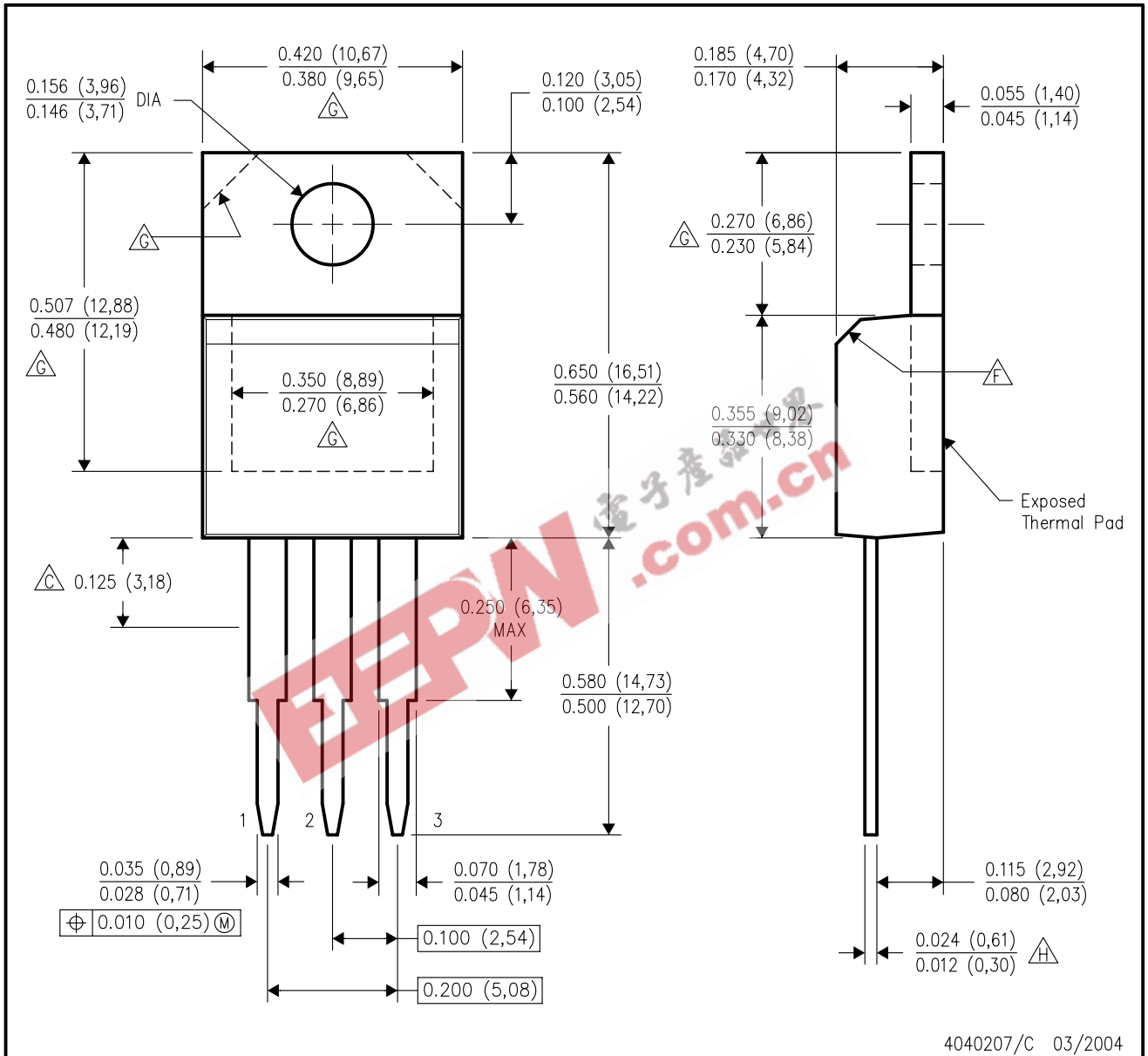

- NOTES:
- A. All linear dimensions are in inches (millimeters).
 - B. This drawing is subject to change without notice.
 - C. Lead dimensions are not controlled within this area.
 - D. All lead dimensions apply before solder dip.
 - E. The center lead is in electrical contact with the mounting tab.
 - F. The chamfer is optional.
 - G. Thermal pad contour optional within these dimensions.
 - H. Falls within JEDEC TO-220 variation AB, except minimum lead thickness.

IMPORTANT NOTICE

Texas Instruments Incorporated and its subsidiaries (TI) reserve the right to make corrections, modifications, enhancements, improvements, and other changes to its products and services at any time and to discontinue any product or service without notice. Customers should obtain the latest relevant information before placing orders and should verify that such information is current and complete. All products are sold subject to TI's terms and conditions of sale supplied at the time of order acknowledgment.

TI warrants performance of its hardware products to the specifications applicable at the time of sale in accordance with TI's standard warranty. Testing and other quality control techniques are used to the extent TI deems necessary to support this warranty. Except where mandated by government requirements, testing of all parameters of each product is not necessarily performed.

TI assumes no liability for applications assistance or customer product design. Customers are responsible for their products and applications using TI components. To minimize the risks associated with customer products and applications, customers should provide adequate design and operating safeguards.

TI does not warrant or represent that any license, either express or implied, is granted under any TI patent right, copyright, mask work right, or other TI intellectual property right relating to any combination, machine, or process in which TI products or services are used. Information published by TI regarding third-party products or services does not constitute a license from TI to use such products or services or a warranty or endorsement thereof. Use of such information may require a license from a third party under the patents or other intellectual property of the third party, or a license from TI under the patents or other intellectual property of TI.

Reproduction of information in TI data books or data sheets is permissible only if reproduction is without alteration and is accompanied by all associated warranties, conditions, limitations, and notices. Reproduction of this information with alteration is an unfair and deceptive business practice. TI is not responsible or liable for such altered documentation.

Resale of TI products or services with statements different from or beyond the parameters stated by TI for that product or service voids all express and any implied warranties for the associated TI product or service and is an unfair and deceptive business practice. TI is not responsible or liable for any such statements.

Following are URLs where you can obtain information on other Texas Instruments products and application solutions:

Products		Applications	
Amplifiers	amplifier.ti.com	Audio	www.ti.com/audio
Data Converters	dataconverter.ti.com	Automotive	www.ti.com/automotive
DSP	dsp.ti.com	Broadband	www.ti.com/broadband
Interface	interface.ti.com	Digital Control	www.ti.com/digitalcontrol
Logic	logic.ti.com	Military	www.ti.com/military
Power Mgmt	power.ti.com	Optical Networking	www.ti.com/opticalnetwork
Microcontrollers	microcontroller.ti.com	Security	www.ti.com/security
Low Power Wireless	www.ti.com/lpw	Telephony	www.ti.com/telephony
		Video & Imaging	www.ti.com/video
		Wireless	www.ti.com/wireless

Mailing Address: Texas Instruments
Post Office Box 655303 Dallas, Texas 75265