

# TL7757 SUPPLY-VOLTAGE SUPERVISOR AND PRECISION VOLTAGE DETECTOR

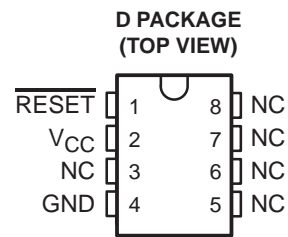
SLVS041E – SEPTEMBER 1991 – REVISED JULY 1999

- Power-On Reset Generator
- Automatic Reset Generation After Voltage Drop
- Low Standby Current . . . 20  $\mu$ A
- Reset Output Defined When  $V_{CC}$  Exceeds 1 V
- Complementary Reset Output
- True and Complementary Reset Outputs
- Precision Threshold Voltage  
4.55 V  $\pm$  120 mV
- High Output Sink Capability . . . 20 mA
- Comparator Hysteresis Prevents Erratic Resets

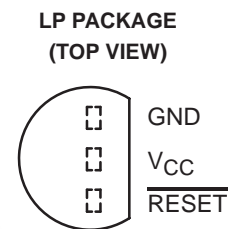
## description

The TL7757 is a supply-voltage supervisor designed for use in microcomputer and microprocessor systems. The supervisor monitors the supply voltage for undervoltage conditions. During power up, when the supply voltage,  $V_{CC}$ , attains a value approaching 1 V, the  $\overline{\text{RESET}}$  output becomes active (low) to prevent undefined operation. If the supply voltage drops below threshold voltage level ( $V_{IT-}$ ), the  $\overline{\text{RESET}}$  output goes to the active (low) level until the supply undervoltage fault condition is eliminated.

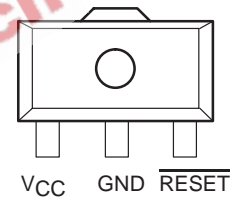
The TL7757C is characterized for operation from 0°C to 70°C. The TL7757I is characterized for operation from -40°C to 85°C.



NC—No internal connection



**PK PACKAGE  
(TOP VIEW)**



GND is in electrical contact with the tab.

### AVAILABLE OPTIONS

$T_A$	PACKAGED DEVICES			CHIP FORM (Y)
	SMALL OUTLINE (D)	TO-226AA (LP)	SOT-89 (PK)	
0°C to 70°C	TL7757CD	TL7757CLP	TL7757CPK	TL7757Y
-40°C to 85°C	TL7757ID	TL7757ILP	TL7757IPK	

D and LP packages are available taped and reeled. Add the suffix R to device type (e.g., TL7757CDR). Chip forms are tested at 25°C.



Please be aware that an important notice concerning availability, standard warranty, and use in critical applications of Texas Instruments semiconductor products and disclaimers thereto appears at the end of this data sheet.

PRODUCTION DATA information is current as of publication date. Products conform to specifications per the terms of Texas Instruments standard warranty. Production processing does not necessarily include testing of all parameters.

**TEXAS  
INSTRUMENTS**

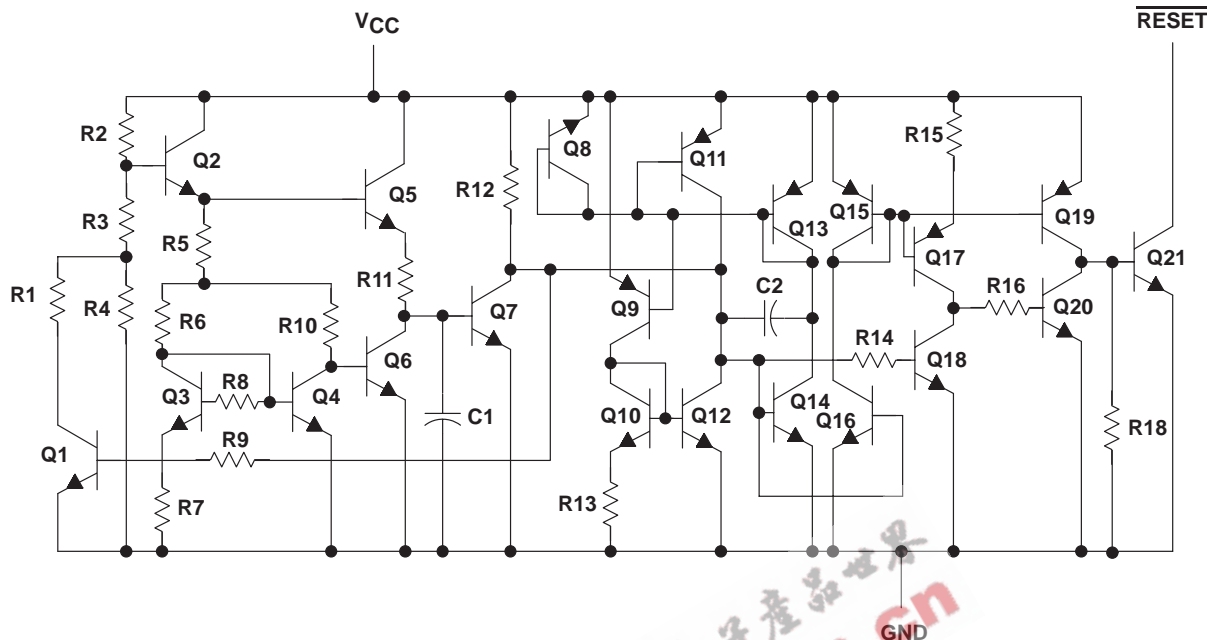
POST OFFICE BOX 655303 • DALLAS, TEXAS 75265

Copyright © 1999, Texas Instruments Incorporated

# TL7757 SUPPLY-VOLTAGE SUPERVISOR AND PRECISION VOLTAGE DETECTOR

SLVS041E – SEPTEMBER 1991 – REVISED JULY 1999

## equivalent schematic



ACTUAL DEVICE COMPONENT COUNT	
Transistors	27
Resistors	20
Capacitors	2

## absolute maximum ratings over operating free-air temperature (unless otherwise noted)†

Supply voltage range, $V_{CC}$ (see Note 1)	–0.3 V to 20 V
Offstate output voltage range (see Note 1)	–0.3 V to 20 V
Output current, $I_O$	30 mA
Package thermal impedance, $\theta_{JA}$ (see Notes 2 and 3):	
D package	97°C/W
LP package	156°C/W
PK package	52°C/W
Lead temperature 1,6 mm (1/16 inch) from case for 10 seconds	260°C
Storage temperature range, $T_{STG}$	–65°C to 150°C

† Stresses beyond those listed under “absolute maximum ratings” may cause permanent damage to the device. These are stress ratings only, and functional operation of the device at these or any other conditions beyond those indicated under “recommended operating conditions” is not implied. Exposure to absolute-maximum-rated conditions for extended periods may affect device reliability.

NOTES: 1. All voltage values are with respect to network terminal ground.

- Maximum power dissipation is a function of  $T_J(\max)$ ,  $\theta_{JA}$ , and  $T_A$ . The maximum allowable power dissipation at any allowable ambient temperature is  $P_D = (T_J(\max) - T_A)/\theta_{JA}$ . Operating at the absolute maximum  $T_J$  of 150°C can impact reliability.
- The package thermal impedance is calculated in accordance with JESD 51, except for through-hole packages, which use a trace length of zero.

**TL7757**  
**SUPPLY-VOLTAGE SUPERVISOR**  
**AND PRECISION VOLTAGE DETECTOR**

SLVS041E – SEPTEMBER 1991 – REVISED JULY 1999

**recommended operating conditions**

		MIN	MAX	UNIT
Supply voltage, $V_{CC}$		1	7	V
High-level output voltage, $V_{OH}$			15	V
Low-level output current, $I_{OL}$			20	mA
Operating free-air temperature, $T_A$	TL7757C	0	70	°C
	TL7757I	-40	85	

**electrical characteristics at specified free-air temperature**

PARAMETER	TEST CONDITIONS	$T_A$	TL7757C			UNIT
			MIN	TYP	MAX	
$V_{IT-}$ Negative-going input threshold voltage at $V_{CC}$		25°C	4.43	4.55	4.67	V
		0°C to 70°C	4.4		4.7	
$V_{hys}^\dagger$ Hysteresis at $V_{CC}$		25°C	40	50	60	mV
		0°C to 70°C	30		70	
$V_{OL}$ Low-level output voltage	$I_{OL} = 20$ mA, $V_{CC} = 4.3$ V	25°C		0.4	0.8	V
		0°C to 70°C			0.8	
$I_{OH}$ High-level output current	$V_{CC} = 7$ V, $V_{OH} = 15$ V, See Figure 1	25°C			1	µA
		0°C to 70°C			1	
$V_{res}^\ddagger$ Power-up reset voltage	$R_L = 2.2$ kΩ, $V_{CC}$ slew rate $\leq 5$ V/µs	25°C		0.8	1	V
		0°C to 70°C			1.2	
$I_{CC}$ Supply current	$V_{CC} = 4.3$ V	25°C		1400	2000	µA
		0°C to 70°C			2000	
		0°C to 70°C			40	

$^\dagger$  This is the difference between positive-going input threshold voltage,  $V_{IT+}$ , and negative-going input threshold voltage,  $V_{IT-}$ .

$^\ddagger$  This is the lowest voltage at which RESET becomes active.

**switching characteristics at specified free-air temperature**

PARAMETER	TEST CONDITIONS	$T_A$	TL7757C			UNIT
			MIN	TYP	MAX	
$t_{PLH}$ Propagation delay time, low-to-high-level output	$V_{CC}$ slew rate $\leq 5$ V/µs, See Figures 2 and 3	25°C		3.4	5	µs
		0°C to 70°C			5	
$t_{PHL}$ Propagation delay time, high-to-low-level output	See Figures 2 and 3	25°C		2	5	µs
		0°C to 70°C			5	
$t_r$ Rise time	$V_{CC}$ slew rate $\leq 5$ V/µs, See Figures 2 and 3	25°C		0.4	1	µs
		0°C to 70°C			1	
$t_f$ Fall time	See Figures 2 and 3	25°C		0.05	1	µs
		0°C to 70°C			1	
$t_{w(min)}$ Minimum pulse duration at $V_{CC}$ for output response		25°C			5	µs
		0°C to 70°C			5	

**TL7757**  
**SUPPLY-VOLTAGE SUPERVISOR**  
**AND PRECISION VOLTAGE DETECTOR**

SLVS041E – SEPTEMBER 1991 – REVISED JULY 1999

**electrical characteristics at specified free-air temperature**

PARAMETER	TEST CONDITIONS	T <sub>A</sub>	TL7757I			UNIT
			MIN	TYP	MAX	
V <sub>IT-</sub> Negative-going input threshold voltage at V <sub>CC</sub>		25°C	4.43	4.55	4.67	V
		-40°C to 85°C	4.4		4.7	
V <sub>hys</sub> <sup>†</sup> Hysteresis at V <sub>CC</sub>		25°C	40	50	60	mV
		-40°C to 85°C	30		70	
V <sub>OL</sub> Low-level output voltage	I <sub>OL</sub> = 20 mA, V <sub>CC</sub> = 4.3 V	25°C		0.4	0.8	V
		-40°C to 85°C			0.8	
I <sub>OH</sub> High-level output current	V <sub>CC</sub> = 7 V, V <sub>OH</sub> = 15 V, See Figure 1	25°C			1	μA
		-40°C to 85°C			1	
V <sub>res</sub> <sup>‡</sup> Power-up reset voltage	R <sub>L</sub> = 2.2 kΩ, V <sub>CC</sub> slew rate ≤ 5 V/μs	25°C		0.8	1	V
		-40°C to 85°C			1.2	
I <sub>CC</sub> Supply current	V <sub>CC</sub> = 4.3 V	25°C		1400	2000	μA
		-40°C to 85°C			2100	
		-40°C to 85°C			40	

<sup>†</sup> This is the difference between positive-going input threshold voltage, V<sub>IT+</sub>, and negative-going input threshold voltage, V<sub>IT-</sub>.

<sup>‡</sup> This is the lowest voltage at which RESET becomes active.

**switching characteristics at specified free-air temperature**

PARAMETER	TEST CONDITIONS	T <sub>A</sub>	TL7757I			UNIT
			MIN	TYP	MAX	
t <sub>PLH</sub> Propagation delay time, low-to-high-level output	V <sub>CC</sub> slew rate ≤ 5 V/μs, See Figures 2 and 3	25°C		3.4	5	μs
		-40°C to 85°C			5	
t <sub>PHL</sub> Propagation delay time, high-to-low-level output	See Figures 2 and 3	25°C		2	5	μs
		-40°C to 85°C			5	
t <sub>r</sub> Rise time	V <sub>CC</sub> slew rate ≤ 5 V/μs, See Figures 2 and 3	25°C		0.4	1	μs
		-40°C to 85°C			1	
t <sub>f</sub> Fall time	See Figures 2 and 3	25°C		0.05	1	μs
		-40°C to 85°C			1	
t <sub>w(min)</sub> Minimum pulse duration at V <sub>CC</sub> for output response		25°C			5	μs
		-40°C to 85°C			5	

**TL7757**  
**SUPPLY-VOLTAGE SUPERVISOR**  
**AND PRECISION VOLTAGE DETECTOR**

SLVS041E – SEPTEMBER 1991 – REVISED JULY 1999

**electrical characteristics at  $T_A = 25^\circ\text{C}$**

PARAMETER	TEST CONDITIONS	TL7757Y			UNIT
		MIN	TYP	MAX	
$V_{IT-}$	Negative-going input threshold voltage at $V_{CC}$		4.55		V
$V_{hys}^\dagger$	Hysteresis at $V_{CC}$		50		mV
$V_{OL}$	Low-level output voltage	$I_{OL} = 20\text{ mA}$ , $V_{CC} = 4.3\text{ V}$	0.4		V
$I_{OH}$	High-level output current	$V_{CC} = 7\text{ V}$ , $V_{OH} = 15\text{ V}$ , See Figure 1			$\mu\text{A}$
$V_{res}^\ddagger$	Power-up reset voltage	$R_L = 2.2\text{ k}\Omega$ , $V_{CC}$ slew rate $\leq 5\text{ V}/\mu\text{s}$	0.8		V
$I_{CC}$	Supply current	$V_{CC} = 4.3\text{ V}$	1400		$\mu\text{A}$
		$V_{CC} = 5.5\text{ V}$			

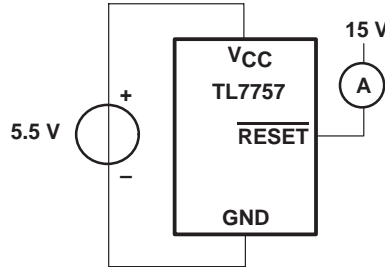
$^\dagger$  This is the difference between positive-going input threshold voltage,  $V_{IT+}$ , and negative-going input threshold voltage,  $V_{IT-}$ .

$^\ddagger$  This is the lowest voltage at which RESET becomes active.

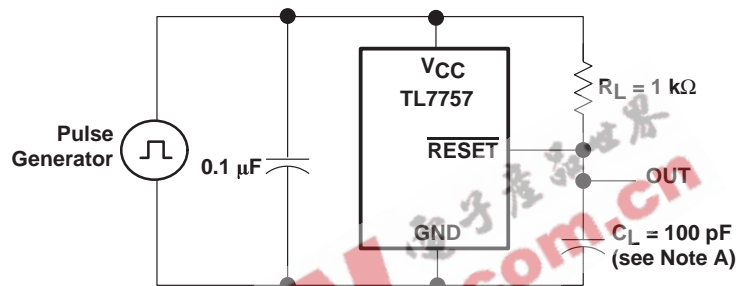
**switching characteristics at  $T_A = 25^\circ\text{C}$**

PARAMETER	TEST CONDITIONS	TL7757Y			UNIT
		MIN	TYP	MAX	
$t_{PLH}$	Propagation delay time, low-to-high-level output	$V_{CC}$ slew rate $\leq 5\text{ V}/\mu\text{s}$ , See Figures 2 and 3	3.4		$\mu\text{s}$
$t_{PHL}$	Propagation delay time, high-to-low-level output	See Figures 2 and 3	2		$\mu\text{s}$
$t_r$	Rise time	$V_{CC}$ slew rate $\leq 5\text{ V}/\mu\text{s}$ , See Figures 2 and 3	0.4		$\mu\text{s}$
$t_f$	Fall time	See Figures 2 and 3	0.05		$\mu\text{s}$

**PARAMETER MEASUREMENT INFORMATION**

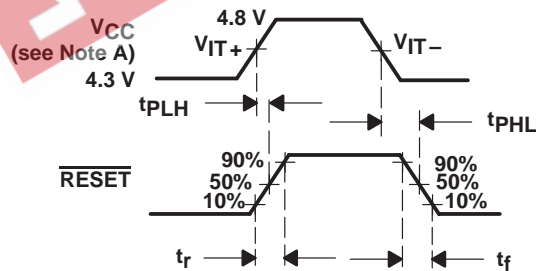


**Figure 1. Test Circuit for Output Leakage Current**



NOTE A: Includes jig and probe capacitance.

**Figure 2. Test Circuit for RESET Output Switching Characteristics**



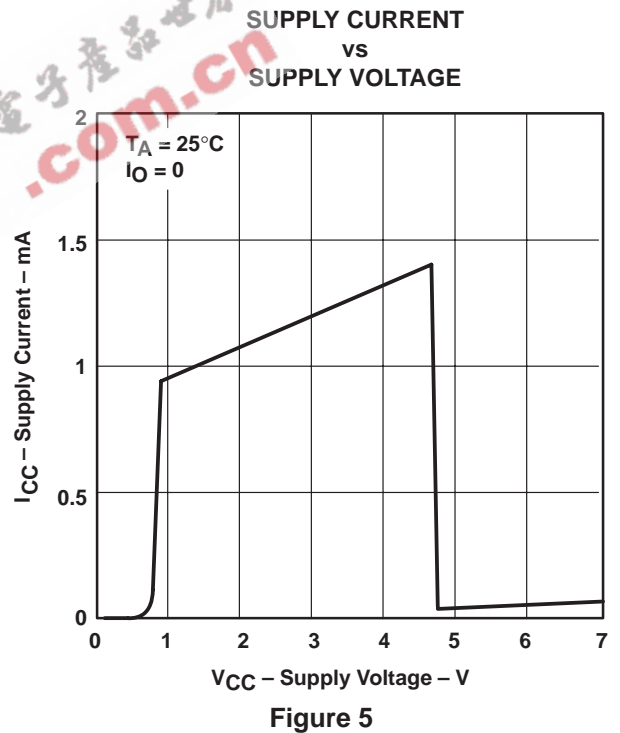
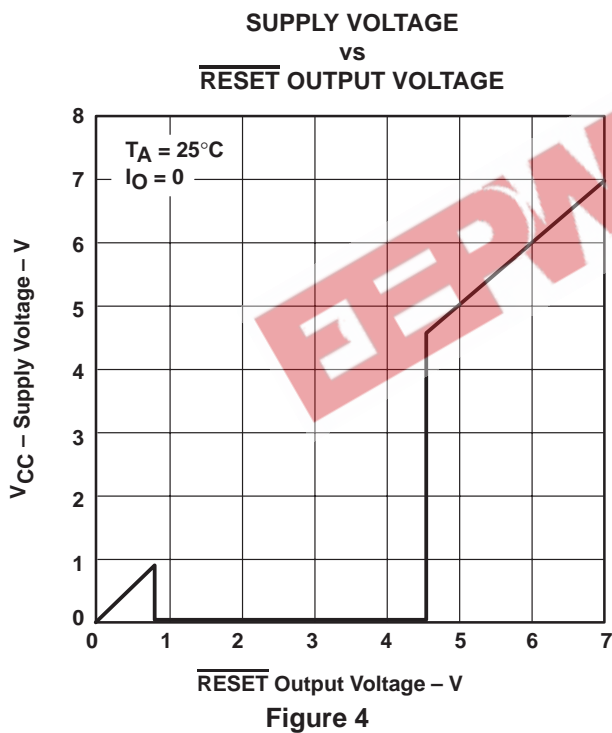
NOTE A:  $V_{CC}$  slew rate  $\leq 5 \mu s$

**Figure 3. Switching Diagram**

**TYPICAL CHARACTERISTICS†**

**Table of Graphs**

		FIGURE
$V_{CC}$	Supply voltage vs $\overline{\text{RESET}}$ output voltage	4
$I_{CC}$	Supply current vs Supply voltage	5
$I_{CC}$	Supply current vs Free-air temperature	6
$V_{OL}$	Low-level output voltage vs Low-level output current	7
$V_{OL}$	Low-level output voltage vs Free-air temperature	8
$I_{OL}$	Output current vs Supply voltage	9
$V_{IT-}$	Input threshold voltage (negative-going $V_{CC}$ ) vs Free-air temperature	10
$V_{res}$	Power-up reset voltage vs Free-air temperature	11
$V_{res}$	Power-up reset voltage and supply voltage vs Time	12
	Propagation delay time	13

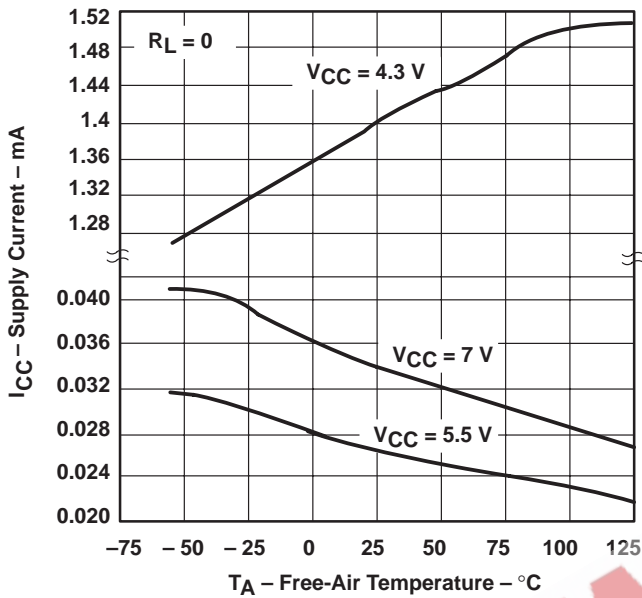


† Data at high and low temperatures are applicable only within the rated operating free-air temperature ranges of the various devices.

**TL7757**  
**SUPPLY-VOLTAGE SUPERVISOR**  
**AND PRECISION VOLTAGE DETECTOR**  
 SLVS041E – SEPTEMBER 1991 – REVISED JULY 1999

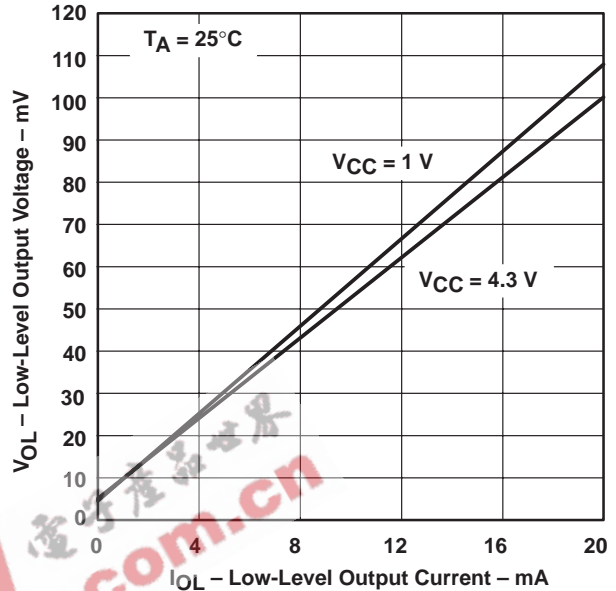
**TYPICAL CHARACTERISTICS†**

**SUPPLY CURRENT**  
**vs**  
**FREE-AIR TEMPERATURE**



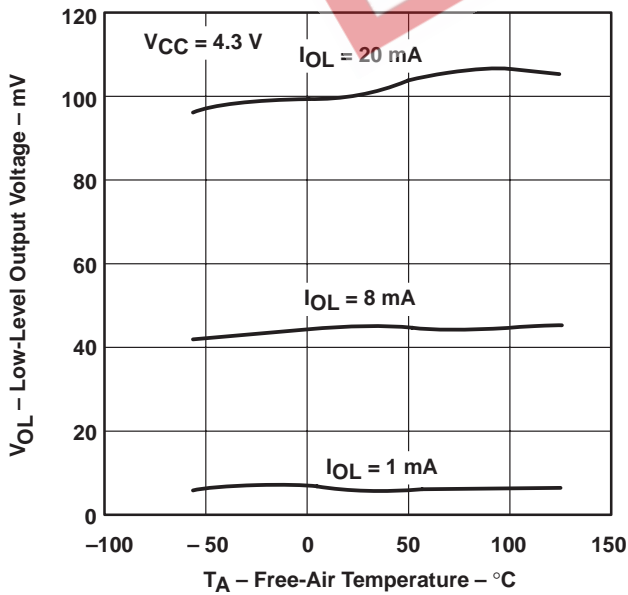
**Figure 6**

**LOW-LEVEL OUTPUT VOLTAGE**  
**vs**  
**LOW-LEVEL OUTPUT CURRENT**



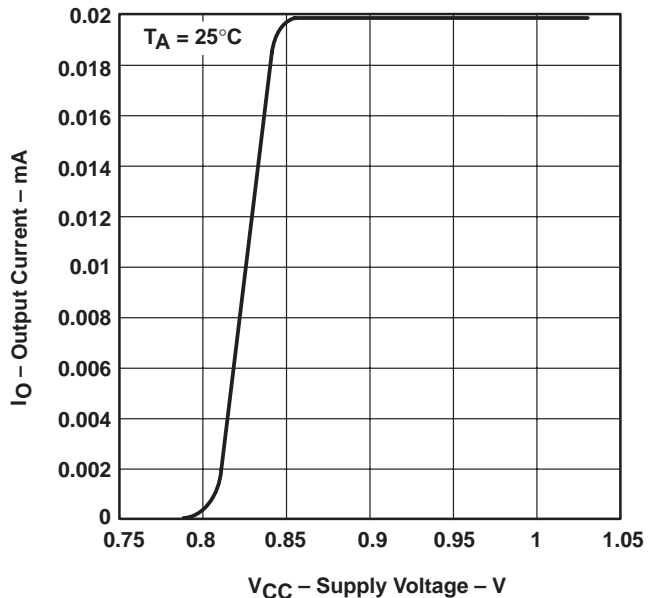
**Figure 7**

**LOW-LEVEL OUTPUT VOLTAGE**  
**vs**  
**FREE-AIR TEMPERATURE**



**Figure 8**

**OUTPUT CURRENT**  
**vs**  
**SUPPLY VOLTAGE**



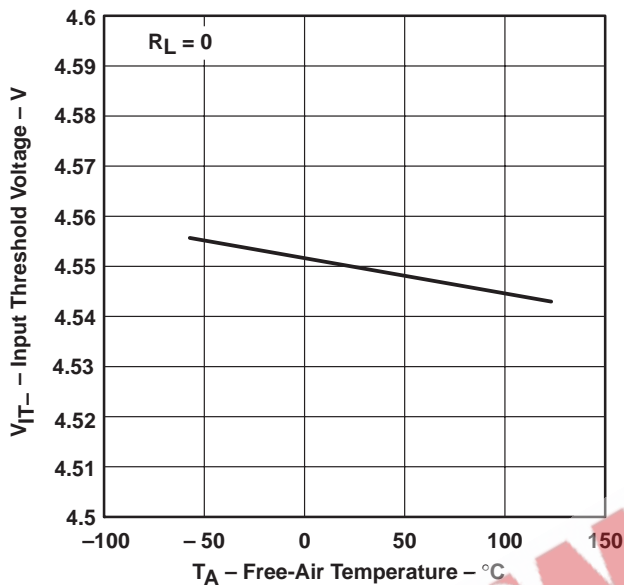
**Figure 9**

† Data at high and low temperatures are applicable only within the rated operating free-air temperature ranges of the various devices.



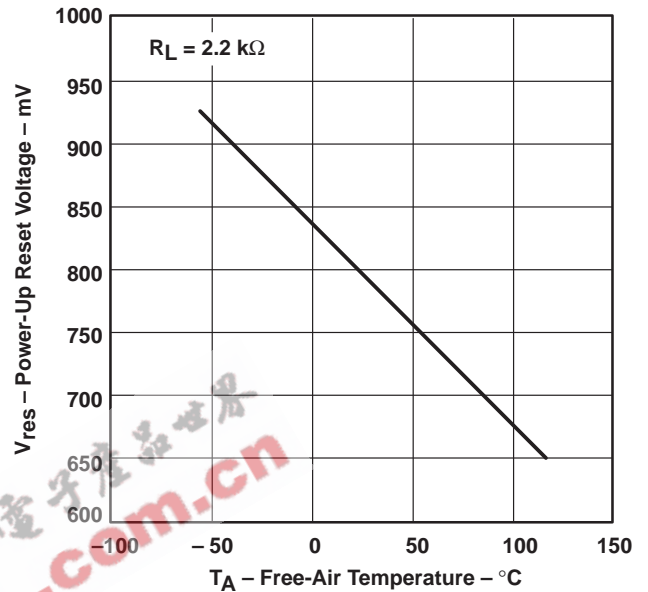
**TYPICAL CHARACTERISTICS†**

**INPUT THRESHOLD VOLTAGE  
 (NEGATIVE-GOING  $V_{CC}$ )  
 vs  
 FREE-AIR TEMPERATURE**



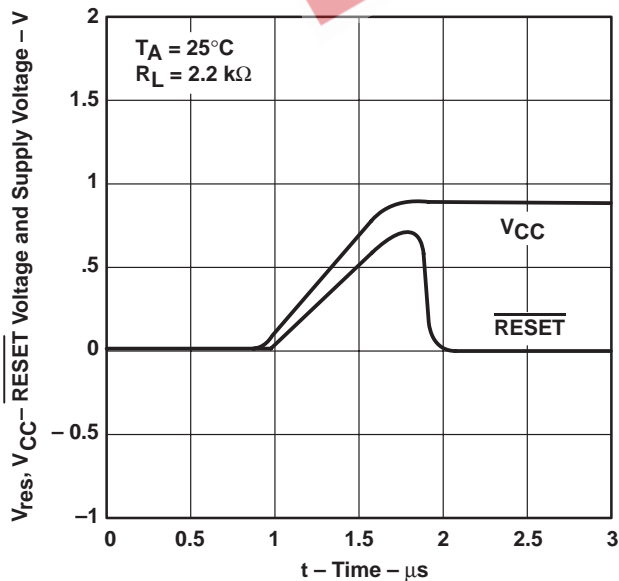
**Figure 10**

**POWER-UP RESET VOLTAGE  
 vs  
 FREE-AIR TEMPERATURE**



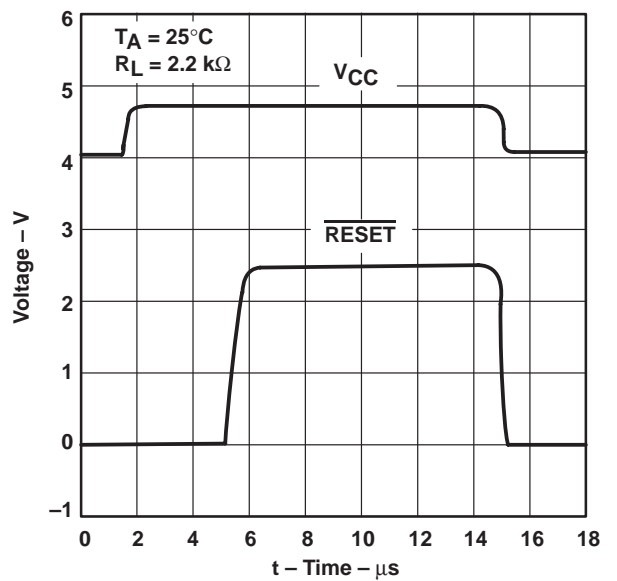
**Figure 11**

**POWER-UP RESET VOLTAGE  
 AND SUPPLY VOLTAGE  
 vs  
 TIME**



**Figure 12**

**PROPAGATION DELAY TIME**



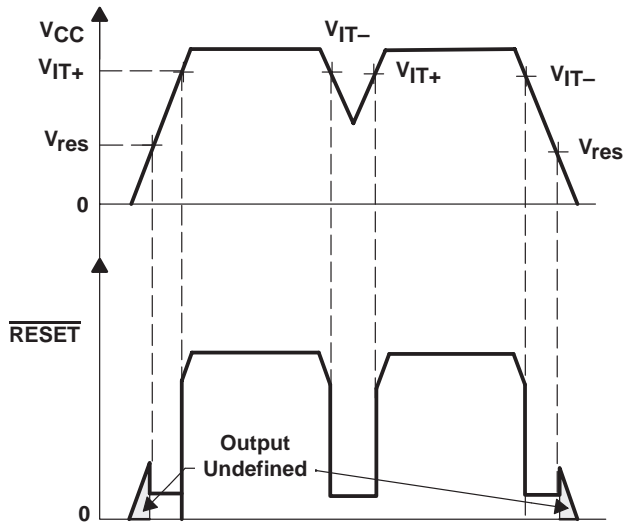
**Figure 13**

† Data at high and low temperatures are applicable only within the rated operating free-air temperature ranges of the various devices.

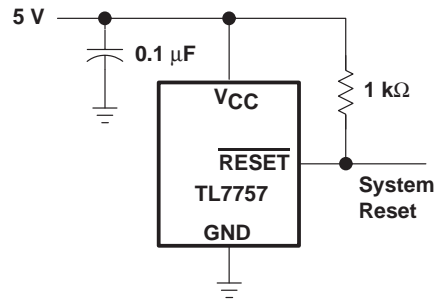
**TL7757**  
**SUPPLY-VOLTAGE SUPERVISOR**  
**AND PRECISION VOLTAGE DETECTOR**  
 SLVS041E – SEPTEMBER 1991 – REVISED JULY 1999

**APPLICATION INFORMATION**

TYPICAL TIMING DIAGRAM



TYPICAL APPLICATION DIAGRAM



EEPW 电子产品世界 .com.cn

## IMPORTANT NOTICE

Texas Instruments and its subsidiaries (TI) reserve the right to make changes to their products or to discontinue any product or service without notice, and advise customers to obtain the latest version of relevant information to verify, before placing orders, that information being relied on is current and complete. All products are sold subject to the terms and conditions of sale supplied at the time of order acknowledgement, including those pertaining to warranty, patent infringement, and limitation of liability.

TI warrants performance of its semiconductor products to the specifications applicable at the time of sale in accordance with TI's standard warranty. Testing and other quality control techniques are utilized to the extent TI deems necessary to support this warranty. Specific testing of all parameters of each device is not necessarily performed, except those mandated by government requirements.

CERTAIN APPLICATIONS USING SEMICONDUCTOR PRODUCTS MAY INVOLVE POTENTIAL RISKS OF DEATH, PERSONAL INJURY, OR SEVERE PROPERTY OR ENVIRONMENTAL DAMAGE ("CRITICAL APPLICATIONS"). TI SEMICONDUCTOR PRODUCTS ARE NOT DESIGNED, AUTHORIZED, OR WARRANTED TO BE SUITABLE FOR USE IN LIFE-SUPPORT DEVICES OR SYSTEMS OR OTHER CRITICAL APPLICATIONS. INCLUSION OF TI PRODUCTS IN SUCH APPLICATIONS IS UNDERSTOOD TO BE FULLY AT THE CUSTOMER'S RISK.

In order to minimize risks associated with the customer's applications, adequate design and operating safeguards must be provided by the customer to minimize inherent or procedural hazards.

TI assumes no liability for applications assistance or customer product design. TI does not warrant or represent that any license, either express or implied, is granted under any patent right, copyright, mask work right, or other intellectual property right of TI covering or relating to any combination, machine, or process in which such semiconductor products or services might be or are used. TI's publication of information regarding any third party's products or services does not constitute TI's approval, warranty or endorsement thereof.