

TLC080, TLC081, TLC082, TLC083, TLC084, TLC085, TLC08xA FAMILY OF WIDE-BANDWIDTH HIGH-OUTPUT-DRIVE SINGLE SUPPLY OPERATIONAL AMPLIFIERS

SLOS254E – JUNE 1999 – REVISED APRIL 2006

- **Wide Bandwidth . . . 10 MHz**
- **High Output Drive**
 - I_{OH} . . . 57 mA at $V_{DD} = 1.5$ V
 - I_{OL} . . . 55 mA at 0.5 V
- **High Slew Rate**
 - $SR+$. . . 16 V/ μ s
 - $SR-$. . . 19 V/ μ s
- **Wide Supply Range . . . 4.5 V to 16 V**
- **Supply Current . . . 1.9 mA/Channel**
- **Ultralow Power Shutdown Mode**
 I_{DD} . . . 125 μ A/Channel
- **Low Input Noise Voltage . . . 8.5 nV/ \sqrt{Hz}**
- **Input Offset Voltage . . . 60 μ V**
- **Ultra-Small Packages**
 - 8 or 10 Pin MSOP (TLC080/1/2/3)

Operational Amplifier

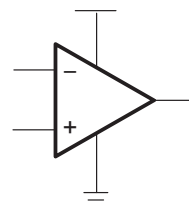

description

The first members of TI's new BiMOS general-purpose operational amplifier family are the TLC08x. The BiMOS family concept is simple: provide an upgrade path for BiFET users who are moving away from dual-supply to single-supply systems and demand higher ac and dc performance. With performance rated from 4.5 V to 16 V across commercial (0°C to 70°C) and an extended industrial temperature range (–40°C to 125°C), BiMOS suits a wide range of audio, automotive, industrial, and instrumentation applications. Familiar features like offset nulling pins, and new features like MSOP PowerPAD™ packages and shutdown modes, enable higher levels of performance in a variety of applications.

Developed in TI's patented LBC3 BiCMOS process, the new BiMOS amplifiers combine a very high input impedance, low-noise CMOS front end with a high-drive bipolar output stage, thus providing the optimum performance features of both. AC performance improvements over the TL08x BiFET predecessors include a bandwidth of 10 MHz (an increase of 300%) and voltage noise of 8.5 nV/ \sqrt{Hz} (an improvement of 60%). DC improvements include an ensured V_{ICR} that includes ground, a factor of 4 reduction in input offset voltage down to 1.5 mV (maximum) in the standard grade, and a power supply rejection improvement of greater than 40 dB to 130 dB. Added to this list of impressive features is the ability to drive ± 50 -mA loads comfortably from an ultrasmall-footprint MSOP PowerPAD package, which positions the TLC08x as the ideal high-performance general-purpose operational amplifier family.

FAMILY PACKAGE TABLE

| DEVICE | NO. OF CHANNELS | PACKAGE TYPES | | | | SHUTDOWN | UNIVERSAL EVM BOARD |
|--------|-----------------|---------------|------|------|-------|----------|---|
| | | MSOP | PDIP | SOIC | TSSOP | | |
| TLC080 | 1 | 8 | 8 | 8 | — | Yes | Refer to the EVM Selection Guide (Lit# SLOU060) |
| TLC081 | 1 | 8 | 8 | 8 | — | — | |
| TLC082 | 2 | 8 | 8 | 8 | — | — | |
| TLC083 | 2 | 10 | 14 | 14 | — | Yes | |
| TLC084 | 4 | — | 14 | 14 | 20 | — | |
| TLC085 | 4 | — | 16 | 16 | 20 | Yes | |



Please be aware that an important notice concerning availability, standard warranty, and use in critical applications of Texas Instruments semiconductor products and disclaimers thereto appears at the end of this data sheet.

PowerPAD is a trademark of Texas Instruments. All other trademarks are the property of their respective owners.

PRODUCTION DATA information is current as of publication date. Products conform to specifications per the terms of Texas Instruments standard warranty. Production processing does not necessarily include testing of all parameters.

 **TEXAS
INSTRUMENTS**
WWW.TI.COM

Copyright © 2000–2006 Texas Instruments Incorporated

TLC080, TLC081, TLC082, TLC083, TLC084, TLC085, TLC08xA FAMILY OF WIDE-BANDWIDTH HIGH-OUTPUT-DRIVE SINGLE SUPPLY OPERATIONAL AMPLIFIERS

SLOS254E – JUNE 1999 – REVISED APRIL 2006

TLC080 and TLC081 AVAILABLE OPTIONS

| T _A | PACKAGED DEVICES | | | |
|----------------|------------------------|--------------------------|--------------------|------------------------|
| | SMALL OUTLINE (D)† | SMALL OUTLINE (DGN)† | SYMBOL | PLASTIC DIP (P) |
| 0°C to 70°C | TLC080CD TLC081CD | TLC080CDGN TLC081CDGN | xxTIACW xxTIACY | TLC080CP TLC081CP |
| –40°C to 125°C | TLC080ID TLC081ID | TLC080IDGN TLC081IDGN | xxTIACX xxTIACZ | TLC080IP TLC081IP |
| | TLC080AID TLC081AID | — — | — — | TLC080AIP TLC081AIP |

† This package is available taped and reeled. To order this packaging option, add an R suffix to the part number (e.g., TLC080CDR).

TLC082 and TLC083 AVAILABLE OPTIONS

| T _A | PACKAGED DEVICES | | | | | | |
|----------------|------------------------|-----------------|--------------|-----------------|--------------|-----------------|-----------------|
| | SMALL OUTLINE (D)† | MSOP | | | | PLASTIC DIP (N) | PLASTIC DIP (P) |
| | | (DGN)† | SYMBOL‡ | (DGQ)† | SYMBOL‡ | | |
| 0°C to 70°C | TLC082CD TLC083CD | TLC082CDGN — | xxTIADZ — | — TLC083CDGQ | — xxTIAEB | — TLC083CN | TLC082CP — |
| –40°C to 125°C | TLC082ID TLC083ID | TLC082IDGN — | xxTIAEA — | — TLC083IDGQ | — xxTIAEC | — TLC083IN | TLC082IP — |
| | TLC082AID TLC083AID | — — | — — | — — | — — | — TLC083AIN | TLC082AIP — |

† This package is available taped and reeled. To order this packaging option, add an R suffix to the part number (e.g., TLC082CDR).

‡ xx represents the device date code.

TLC084 and TLC085 AVAILABLE OPTIONS

| T _A | PACKAGED DEVICES | | |
|----------------|------------------------|------------------------|----------------------------|
| | SMALL OUTLINE (D)† | PLASTIC DIP (N) | TSSOP (PWP)† |
| 0°C to 70°C | TLC084CD TLC085CD | TLC084CN TLC085CN | TLC084CPWP TLC085CPWP |
| –40°C to 125°C | TLC084ID TLC085ID | TLC084IN TLC085IN | TLC084IPWP TLC085IPWP |
| | TLC084AID TLC085AID | TLC084AIN TLC085AIN | TLC084AIPWP TLC085AIPWP |

† This package is available taped and reeled. To order this packaging option, add an R suffix to the part number (e.g., TLC084CDR).

For the most current package and ordering information, see the Package Option Addendum at the end of this data sheet, or see the TI web site at www.ti.com.

TLC080, TLC081, TLC082, TLC083, TLC084, TLC085, TLC08xA FAMILY OF WIDE-BANDWIDTH HIGH-OUTPUT-DRIVE SINGLE SUPPLY OPERATIONAL AMPLIFIERS

SLOS254E – JUNE 1999 – REVISED APRIL 2006

TLC08x PACKAGE PINOUTS

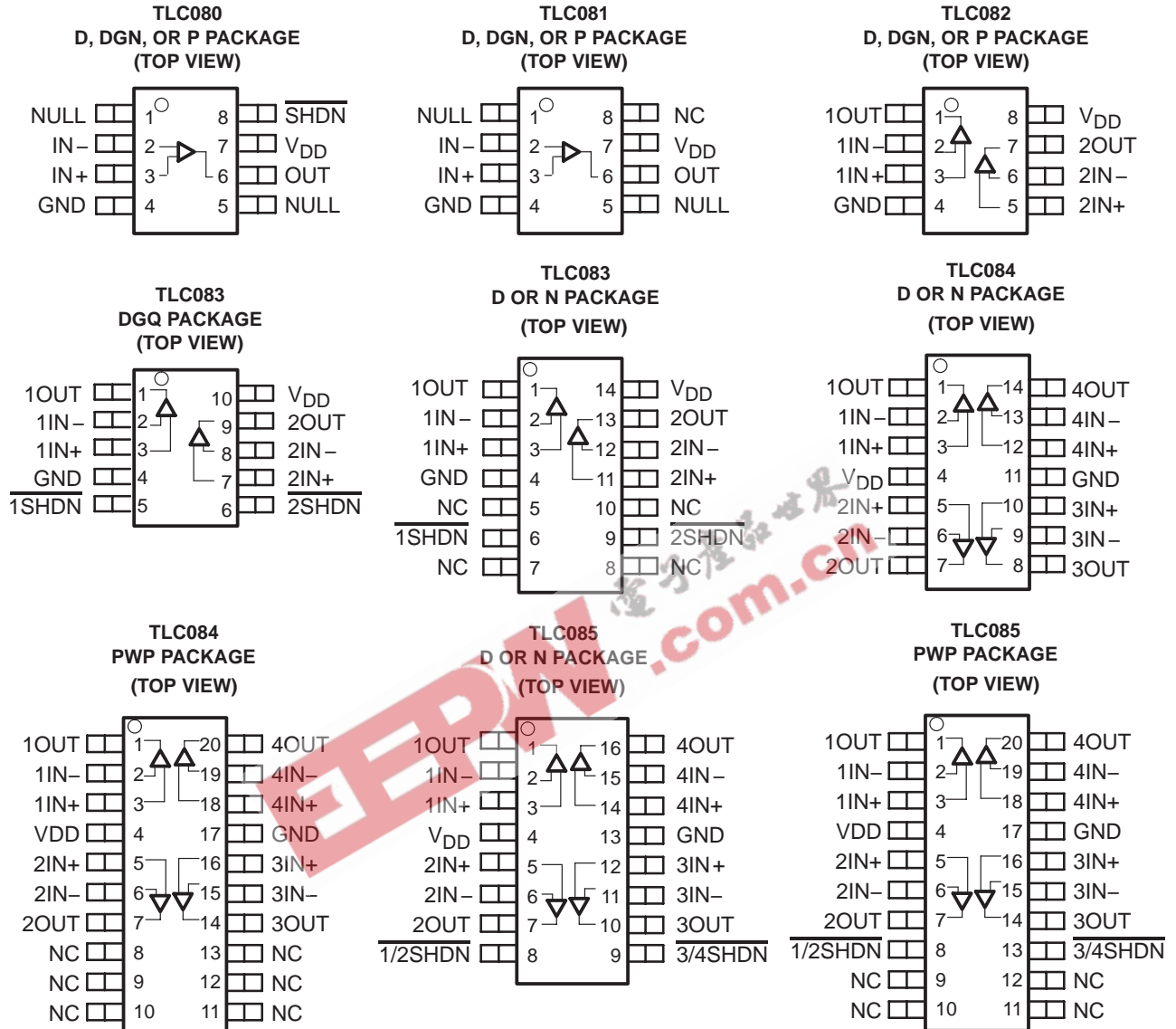

NC – No internal connection

TYPICAL PIN 1 INDICATORS

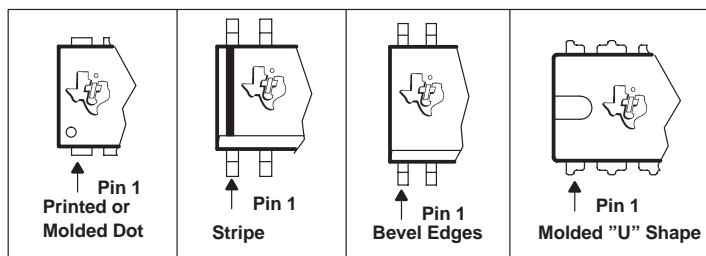

TLC080, TLC081, TLC082, TLC083, TLC084, TLC085, TLC08xA FAMILY OF WIDE-BANDWIDTH HIGH-OUTPUT-DRIVE SINGLE SUPPLY OPERATIONAL AMPLIFIERS

SLOS254E – JUNE 1999 – REVISED APRIL 2006

absolute maximum ratings over operating free-air temperature range (unless otherwise noted)†

| | |
|--|------------------------------|
| Supply voltage, V_{DD} (see Note 1) | 17 V |
| Differential input voltage range, V_{ID} | $\pm V_{DD}$ |
| Continuous total power dissipation | See Dissipation Rating Table |
| Operating free-air temperature range, T_A : C suffix | 0°C to 70°C |
| I suffix | -40°C to 125°C |
| Maximum junction temperature, T_J | 150°C |
| Storage temperature range, T_{stg} | -65°C to 150°C |
| Lead temperature 1,6 mm (1/16 inch) from case for 10 seconds | 260°C |

† Stresses beyond those listed under “absolute maximum ratings” may cause permanent damage to the device. These are stress ratings only, and functional operation of the device at these or any other conditions beyond those indicated under “recommended operating conditions” is not implied. Exposure to absolute-maximum-rated conditions for extended periods may affect device reliability.

NOTE 1: All voltage values, except differential voltages, are with respect to GND.

DISSIPATION RATING TABLE

| PACKAGE | θ_{JC} (°C/W) | θ_{JA} (°C/W) | $T_A \leq 25^\circ\text{C}$ POWER RATING |
|------------|-------------------------|-------------------------|---|
| D (8) | 38.3 | 176 | 710 mW |
| D (14) | 26.9 | 122.3 | 1022 mW |
| D (16) | 25.7 | 114.7 | 1090 mW |
| DGN (8) | 4.7 | 52.7 | 2.37 W |
| DGQ (10) | 4.7 | 52.3 | 2.39 W |
| N (14, 16) | 32 | 78 | 1600 mW |
| P (8) | 41 | 104 | 1200 mW |
| PWP (20) | 1.40 | 26.1 | 4.79 W |

recommended operating conditions

| | | MIN | MAX | UNIT |
|---------------------------------------|---------------|------------|------------|------|
| Supply voltage, V_{DD} | Single supply | 4.5 | 16 | V |
| | Split supply | ± 2.25 | ± 8 | |
| Common-mode input voltage, V_{ICR} | | GND | $V_{DD}-2$ | V |
| Shutdown on/off voltage level‡ | V_{IH} | 2 | | V |
| | V_{IL} | 0.8 | | |
| Operating free-air temperature, T_A | C-suffix | 0 | 70 | °C |
| | I-suffix | -40 | 125 | |

‡ Relative to the voltage on the GND terminal of the device.

TLC080, TLC081, TLC082, TLC083, TLC084, TLC085, TLC08xA FAMILY OF WIDE-BANDWIDTH HIGH-OUTPUT-DRIVE SINGLE SUPPLY OPERATIONAL AMPLIFIERS

SLOS254E – JUNE 1999 – REVISED APRIL 2006

electrical characteristics at specified free-air temperature, $V_{DD} = 5\text{ V}$ (unless otherwise noted)

| PARAMETER | TEST CONDITIONS | T_A † | MIN | TYP | MAX | UNIT |
|--|--|-----------------------------|---------------|----------|-------------|------------------------------|
| V_{IO} Input offset voltage | $V_{DD} = 5\text{ V}$, $V_{IC} = 2.5\text{ V}$, $V_O = 2.5\text{ V}$, $R_S = 50\ \Omega$ | TLC080/1/2/3, TLC084/5 | 25°C | 390 | 1900 | μV |
| | | | Full range | | 3000 | |
| | | TLC080/1/2/3A, TLC084/5A | 25°C | 390 | 1400 | |
| | | | Full range | | 2000 | |
| α_{VIO} Temperature coefficient of input offset voltage | | | | 1.2 | | $\mu\text{V}/^\circ\text{C}$ |
| I_{IO} Input offset current | $V_{DD} = 5\text{ V}$, $V_{IC} = 2.5\text{ V}$, $V_O = 2.5\text{ V}$, $R_S = 50\ \Omega$ | | 25°C | 1.9 | 50 | pA |
| | | TLC08XC TLC08XI | Full range | | 100 700 | |
| I_{IB} Input bias current | $V_{DD} = 5\text{ V}$, $V_{IC} = 2.5\text{ V}$, $V_O = 2.5\text{ V}$, $R_S = 50\ \Omega$ | | 25°C | 3 | 50 | pA |
| | | TLC08XC TLC08XI | Full range | | 100 700 | |
| V_{ICR} Common-mode input voltage | $R_S = 50\ \Omega$ | | 25°C | 0 to 3.0 | 0 to 3.5 | V |
| | | | Full range | | 0 to 3.0 | |
| V_{OH} High-level output voltage | $V_{IC} = 2.5\text{ V}$ | $I_{OH} = -1\text{ mA}$ | 25°C | 4.1 | 4.3 | V |
| | | | Full range | | 3.9 | |
| | | $I_{OH} = -20\text{ mA}$ | 25°C | 3.7 | 4 | |
| | | | Full range | | 3.5 | |
| | | $I_{OH} = -35\text{ mA}$ | 25°C | 3.4 | 3.8 | |
| | | | Full range | | 3.2 | |
| $I_{OH} = -50\text{ mA}$ | 25°C | 3.2 | 3.6 | | | |
| | -40°C to 85°C | | 3 | | | |
| V_{OL} Low-level output voltage | $V_{IC} = 2.5\text{ V}$ | $I_{OL} = 1\text{ mA}$ | 25°C | 0.18 | 0.25 | V |
| | | | Full range | | 0.35 | |
| | | $I_{OL} = 20\text{ mA}$ | 25°C | 0.35 | 0.39 | |
| | | | Full range | | 0.45 | |
| | | $I_{OL} = 35\text{ mA}$ | 25°C | 0.43 | 0.55 | |
| | | | Full range | | 0.7 | |
| | | $I_{OL} = 50\text{ mA}$ | 25°C | 0.45 | 0.63 | |
| | | | -40°C to 85°C | | 0.7 | |
| I_{OS} Short-circuit output current | Sourcing | 25°C | | 100 | mA | |
| | Sinking | 25°C | | 100 | | |
| I_O Output current | $V_{OH} = 1.5\text{ V}$ from positive rail | 25°C | | 57 | mA | |
| | $V_{OL} = 0.5\text{ V}$ from negative rail | 25°C | | 55 | | |

† Full range is 0°C to 70°C for C suffix and -40°C to 125°C for I suffix. If not specified, full range is -40°C to 125°C.

TLC080, TLC081, TLC082, TLC083, TLC084, TLC085, TLC08xA FAMILY OF WIDE-BANDWIDTH HIGH-OUTPUT-DRIVE SINGLE SUPPLY OPERATIONAL AMPLIFIERS

SLOS254E – JUNE 1999 – REVISED APRIL 2006

electrical characteristics at specified free-air temperature, $V_{DD} = 5\text{ V}$ (unless otherwise noted)
(continued)

| PARAMETER | | TEST CONDITIONS | T_A † | MIN | TYP | MAX | UNIT |
|----------------|---|--|------------|-----|------|-----|---------------|
| A_{VD} | Large-signal differential voltage amplification | $V_{O(PP)} = 3\text{ V}$, $R_L = 10\text{ k}\Omega$ | 25°C | 100 | 120 | | dB |
| | | | Full range | 100 | | | |
| $r_{i(d)}$ | Differential input resistance | | 25°C | | 1000 | | $G\Omega$ |
| C_{iC} | Common-mode input capacitance | $f = 10\text{ kHz}$ | 25°C | | 22.9 | | pF |
| z_o | Closed-loop output impedance | $f = 10\text{ kHz}$, $A_V = 10$ | 25°C | | 0.25 | | Ω |
| CMRR | Common-mode rejection ratio | $V_{iC} = 0\text{ to }3\text{ V}$, $R_S = 50\ \Omega$ | 25°C | 80 | 110 | | dB |
| | | | Full range | 80 | | | |
| k_{SVR} | Supply voltage rejection ratio ($\Delta V_{DD} / \Delta V_{iO}$) | $V_{DD} = 4.5\text{ V to }16\text{ V}$, No load $V_{iC} = V_{DD}/2$, | 25°C | 80 | 100 | | dB |
| | | | Full range | 80 | | | |
| I_{DD} | Supply current (per channel) | $V_O = 2.5\text{ V}$, No load | 25°C | | 1.8 | 2.5 | mA |
| | | | Full range | | | 3.5 | |
| $I_{DD(SHDN)}$ | Supply current in shutdown mode (per channel) (TLC080, TLC083, TLC085) | $\overline{SHDN} \leq 0.8\text{ V}$ | 25°C | | 125 | 200 | μA |
| | | | Full range | | | 250 | |

† Full range is 0°C to 70°C for C suffix and –40°C to 125°C for I suffix. If not specified, full range is –40°C to 125°C.



TLC080, TLC081, TLC082, TLC083, TLC084, TLC085, TLC08xA FAMILY OF WIDE-BANDWIDTH HIGH-OUTPUT-DRIVE SINGLE SUPPLY OPERATIONAL AMPLIFIERS

SLOS254E – JUNE 1999 – REVISED APRIL 2006

operating characteristics at specified free-air temperature, $V_{DD} = 5\text{ V}$ (unless otherwise noted)

| PARAMETER | | TEST CONDITIONS | | T_A † | MIN | TYP | MAX | UNIT |
|------------------------|--------------------------------------|--|---------------------------|------------|--------|-----|-----|------------------------------|
| SR+ | Positive slew rate at unity gain | $V_{O(PP)} = 0.8\text{ V}$, $R_L = 10\text{ k}\Omega$ | $C_L = 50\text{ pF}$ | 25°C | 10 | 16 | | $\text{V}/\mu\text{s}$ |
| | | | | Full range | 9.5 | | | |
| SR– | Negative slew rate at unity gain | $V_{O(PP)} = 0.8\text{ V}$, $R_L = 10\text{ k}\Omega$ | $C_L = 50\text{ pF}$ | 25°C | 12.5 | 19 | | $\text{V}/\mu\text{s}$ |
| | | | | Full range | 10 | | | |
| V_n | Equivalent input noise voltage | f = 100 Hz | | 25°C | | 12 | | $\text{nV}/\sqrt{\text{Hz}}$ |
| | | f = 1 kHz | | 25°C | | 8.5 | | |
| I_n | Equivalent input noise current | f = 1 kHz | | 25°C | | 0.6 | | $\text{fA}/\sqrt{\text{Hz}}$ |
| THD + N | Total harmonic distortion plus noise | $V_{O(PP)} = 3\text{ V}$, $R_L = 10\text{ k}\Omega$ and $250\ \Omega$, f = 1 kHz | $A_V = 1$ | 25°C | 0.002% | | | |
| | | | $A_V = 10$ | | 0.012% | | | |
| | | | $A_V = 100$ | | 0.085% | | | |
| $t_{(on)}$ | Amplifier turnon time‡ | $R_L = 10\text{ k}\Omega$ | | 25°C | 0.15 | | | μs |
| $t_{(off)}$ | Amplifier turnoff time‡ | | | 25°C | 1.3 | | | μs |
| Gain-bandwidth product | | f = 10 kHz, | $R_L = 10\text{ k}\Omega$ | 25°C | 10 | | | MHz |
| t_s | Settling time | $V_{(STEP)PP} = 1\text{ V}$, $A_V = -1$, $C_L = 10\text{ pF}$, $R_L = 10\text{ k}\Omega$ | 0.1% | 25°C | 0.18 | | | μs |
| | | | 0.01% | | 0.39 | | | |
| | | $V_{(STEP)PP} = 1\text{ V}$, $A_V = -1$, $C_L = 47\text{ pF}$, $R_L = 10\text{ k}\Omega$ | 0.1% | | 0.18 | | | |
| | | 0.01% | 0.39 | | | | | |
| ϕ_m | Phase margin | $R_L = 10\text{ k}\Omega$, | $C_L = 50\text{ pF}$ | 25°C | 32° | | | |
| | | $R_L = 10\text{ k}\Omega$, | $C_L = 0\text{ pF}$ | | 40° | | | |
| | Gain margin | $R_L = 10\text{ k}\Omega$, | $C_L = 50\text{ pF}$ | 25°C | 2.2 | | | dB |
| | | $R_L = 10\text{ k}\Omega$, | $C_L = 0\text{ pF}$ | | 3.3 | | | |

† Full range is 0°C to 70°C for C suffix and –40°C to 125°C for I suffix. If not specified, full range is –40°C to 125°C.

‡ Disable time and enable time are defined as the interval between application of the logic signal to SHDN and the point at which the supply current has reached half its final value.

TLC080, TLC081, TLC082, TLC083, TLC084, TLC085, TLC08xA FAMILY OF WIDE-BANDWIDTH HIGH-OUTPUT-DRIVE SINGLE SUPPLY OPERATIONAL AMPLIFIERS

SLOS254E – JUNE 1999 – REVISED APRIL 2006

electrical characteristics at specified free-air temperature, $V_{DD} = 12\text{ V}$ (unless otherwise noted)

| PARAMETER | TEST CONDITIONS | T_A † | MIN | TYP | MAX | UNIT | |
|--|---|----------------------------|---------------|-----------|-------------|------------------------------|------------|
| V_{IO} Input offset voltage | $V_{DD} = 12\text{ V}$ $V_{IC} = 6\text{ V}$, $V_O = 6\text{ V}$, $R_S = 50\ \Omega$ | TLC0841/2/3, TLC084/5 | 25°C | 390 | 1900 | μV | |
| | | | Full range | | 3000 | | |
| | | TLC0841/2/3A, TLC084/5A | 25°C | 390 | 1400 | | |
| | | | Full range | | 2000 | | |
| α_{VIO} Temperature coefficient of input offset voltage | | | | 1.2 | | $\mu\text{V}/^\circ\text{C}$ | |
| I_{IO} Input offset current | $V_{DD} = 12\text{ V}$ $V_{IC} = 6\text{ V}$, $V_O = 6\text{ V}$, $R_S = 50\ \Omega$ | | 25°C | 1.5 | 50 | pA | |
| | | TLC08xC TLC08xI | Full range | | 100 700 | | |
| I_{IB} Input bias current | $V_{DD} = 12\text{ V}$ $V_{IC} = 6\text{ V}$, $R_S = 50\ \Omega$ | | 25°C | 2 | 50 | pA | |
| | | TLC08xC TLC08xI | Full range | | 100 700 | | |
| V_{ICR} Common-mode input voltage | $R_S = 50\ \Omega$ | | 25°C | 0 to 10.0 | 0 to 10.5 | V | |
| | | | Full range | | 0 to 10.0 | | 0 to 10.5 |
| V_{OH} High-level output voltage | $V_{IC} = 6\text{ V}$ | $I_{OH} = -1\text{ mA}$ | 25°C | 11.1 | 11.2 | V | |
| | | | Full range | | 11 | | |
| | | $I_{OH} = -20\text{ mA}$ | 25°C | 10.8 | 11 | | |
| | | | Full range | | 10.7 | | |
| | | $I_{OH} = -35\text{ mA}$ | 25°C | 10.6 | 10.7 | | |
| | | | Full range | | 10.3 | | |
| $I_{OH} = -50\text{ mA}$ | 25°C | 10.3 | 10.5 | | | | |
| | -40°C to 85°C | | 10.2 | | | | |
| V_{OL} Low-level output voltage | $V_{IC} = 6\text{ V}$ | $I_{OL} = 1\text{ mA}$ | 25°C | | 0.17 | 0.25 | V |
| | | | Full range | | | 0.35 | |
| | | $I_{OL} = 20\text{ mA}$ | 25°C | | 0.35 | 0.45 | |
| | | | Full range | | | 0.5 | |
| | | $I_{OL} = 35\text{ mA}$ | 25°C | | 0.4 | 0.52 | |
| | | | Full range | | | 0.6 | |
| | | $I_{OL} = 50\text{ mA}$ | 25°C | | 0.45 | 0.6 | |
| | | | -40°C to 85°C | | | 0.65 | |
| I_{OS} Short-circuit output current | Sourcing | 25°C | | 150 | mA | | |
| | Sinking | 25°C | | 150 | | | |
| I_O Output current | $V_{OH} = 1.5\text{ V}$ from positive rail | 25°C | | 57 | mA | | |
| | $V_{OL} = 0.5\text{ V}$ from negative rail | 25°C | | 55 | | | |

† Full range is 0°C to 70°C for C suffix and -40°C to 125°C for I suffix. If not specified, full range is -40°C to 125°C.

TLC080, TLC081, TLC082, TLC083, TLC084, TLC085, TLC08xA
FAMILY OF WIDE-BANDWIDTH HIGH-OUTPUT-DRIVE SINGLE SUPPLY
OPERATIONAL AMPLIFIERS

SLOS254E – JUNE 1999 – REVISED APRIL 2006

electrical characteristics at specified free-air temperature, $V_{DD} = 12\text{ V}$ (unless otherwise noted)
(continued)

| PARAMETER | | TEST CONDITIONS | T_A † | MIN | TYP | MAX | UNIT |
|----------------|--|--|------------|-----|------|-----|---------------|
| A_{VD} | Large-signal differential voltage amplification | $V_{O(PP)} = 8\text{ V}$, $R_L = 10\text{ k}\Omega$ | 25°C | 120 | 140 | | dB |
| | | | Full range | 120 | | | |
| $r_{i(d)}$ | Differential input resistance | | 25°C | | 1000 | | $G\Omega$ |
| C_{iC} | Common-mode input capacitance | $f = 10\text{ kHz}$ | 25°C | | 21.6 | | pF |
| z_o | Closed-loop output impedance | $f = 10\text{ kHz}$, $A_V = 10$ | 25°C | | 0.25 | | Ω |
| CMRR | Common-mode rejection ratio | $V_{iC} = 0\text{ to }10\text{ V}$, $R_S = 50\ \Omega$ | 25°C | 80 | 110 | | dB |
| | | | Full range | 80 | | | |
| k_{SVR} | Supply voltage rejection ratio ($\Delta V_{DD} / \Delta V_{iO}$) | $V_{DD} = 4.5\text{ V to }16\text{ V}$, No load $V_{iC} = V_{DD}/2$, | 25°C | 80 | 100 | | dB |
| | | | Full range | 80 | | | |
| I_{DD} | Supply current (per channel) | $V_O = 7.5\text{ V}$, No load | 25°C | | 1.9 | 2.9 | mA |
| | | | Full range | | | 3.5 | |
| $I_{DD(SHDN)}$ | Supply current in shutdown mode (TLC080, TLC083, TLC085) (per channel) | $\overline{SHDN} \leq 0.8\text{ V}$ | 25°C | | 125 | 200 | μA |
| | | | Full range | | | 250 | |

† Full range is 0°C to 70°C for C suffix and –40°C to 125°C for I suffix. If not specified, full range is –40°C to 125°C.

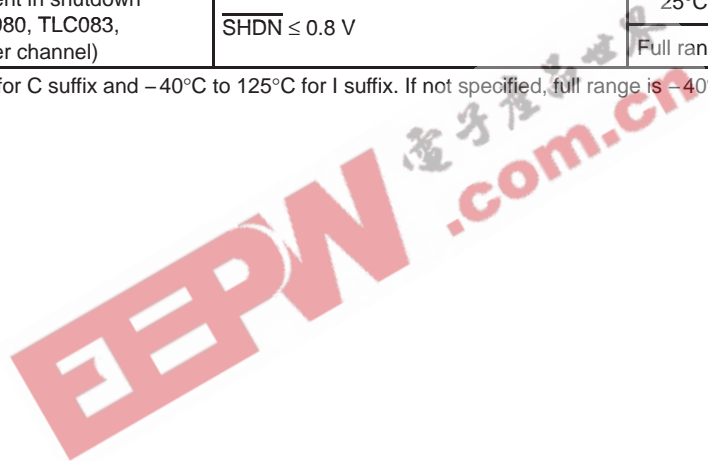

TLC080, TLC081, TLC082, TLC083, TLC084, TLC085, TLC08xA FAMILY OF WIDE-BANDWIDTH HIGH-OUTPUT-DRIVE SINGLE SUPPLY OPERATIONAL AMPLIFIERS

SLOS254E – JUNE 1999 – REVISED APRIL 2006

operating characteristics at specified free-air temperature, $V_{DD} = 12\text{ V}$ (unless otherwise noted)

| PARAMETER | | TEST CONDITIONS | | T_A † | MIN | TYP | MAX | UNIT | |
|------------------------|--------------------------------------|--|---------------------------|------------|------------|-------------|---------------|------------------------|--|
| SR+ | Positive slew rate at unity gain | $V_{O(PP)} = 2\text{ V}$, $R_L = 10\text{ k}\Omega$ | $C_L = 50\text{ pF}$, | 25°C | 10 | 16 | | V/ μs | |
| | | | | Full range | 9.5 | | | | |
| SR– | Negative slew rate at unity gain | $V_{O(PP)} = 2\text{ V}$, $R_L = 10\text{ k}\Omega$ | $C_L = 50\text{ pF}$, | 25°C | 12.5 | 19 | | V/ μs | |
| | | | | Full range | 10 | | | | |
| V_n | Equivalent input noise voltage | $f = 100\text{ Hz}$ | | 25°C | | 14 | | nV/ $\sqrt{\text{Hz}}$ | |
| | | $f = 1\text{ kHz}$ | | 25°C | | 8.5 | | | |
| I_n | Equivalent input noise current | $f = 1\text{ kHz}$ | | 25°C | | 0.6 | | fA/ $\sqrt{\text{Hz}}$ | |
| THD + N | Total harmonic distortion plus noise | $V_{O(PP)} = 8\text{ V}$, $R_L = 10\text{ k}\Omega$ and $250\ \Omega$, $f = 1\text{ kHz}$ | $A_V = 1$ | 25°C | 0.002% | | | | |
| | | | | | $A_V = 10$ | 0.005% | | | |
| | | | | | | $A_V = 100$ | 0.022% | | |
| $t_{(on)}$ | Amplifier turnon time‡ | $R_L = 10\text{ k}\Omega$ | | 25°C | 0.47 | | μs | | |
| $t_{(off)}$ | Amplifier turnoff time‡ | | | 25°C | 2.5 | | μs | | |
| Gain-bandwidth product | | $f = 10\text{ kHz}$, | $R_L = 10\text{ k}\Omega$ | 25°C | 10 | | MHz | | |
| t_s | Settling time | $V_{(STEP)PP} = 1\text{ V}$, $A_V = -1$, $C_L = 10\text{ pF}$, $R_L = 10\text{ k}\Omega$ | 0.1% | 25°C | 0.17 | | μs | | |
| | | | 0.01% | | 0.22 | | | | |
| | | $V_{(STEP)PP} = 1\text{ V}$, $A_V = -1$, $C_L = 47\text{ pF}$, $R_L = 10\text{ k}\Omega$ | 0.1% | | 0.17 | | | | |
| | | | 0.01% | | 0.29 | | | | |
| ϕ_m | Phase margin | $R_L = 10\text{ k}\Omega$, | $C_L = 50\text{ pF}$ | 25°C | 37° | | | | |
| | | $R_L = 10\text{ k}\Omega$, | $C_L = 0\text{ pF}$ | | 42° | | | | |
| | Gain margin | $R_L = 10\text{ k}\Omega$, | $C_L = 50\text{ pF}$ | 25°C | 3.1 | | dB | | |
| | | $R_L = 10\text{ k}\Omega$, | $C_L = 0\text{ pF}$ | | 4 | | | | |

† Full range is 0°C to 70°C for C suffix and –40°C to 125°C for I suffix. If not specified, full range is –40°C to 125°C.

‡ Disable time and enable time are defined as the interval between application of the logic signal to SHDN and the point at which the supply current has reached half its final value.

TLC080, TLC081, TLC082, TLC083, TLC084, TLC085, TLC08xA
FAMILY OF WIDE-BANDWIDTH HIGH-OUTPUT-DRIVE SINGLE SUPPLY
OPERATIONAL AMPLIFIERS

SLOS254E – JUNE 1999 – REVISED APRIL 2006

TYPICAL CHARACTERISTICS

Table of Graphs

| | | | FIGURE |
|-------------|---------------------------------------|--------------------------------|---------------|
| V_{IO} | Input offset voltage | vs Common-mode input voltage | 1, 2 |
| I_{IO} | Input offset current | vs Free-air temperature | 3, 4 |
| I_{IB} | Input bias current | vs Free-air temperature | 3, 4 |
| V_{OH} | High-level output voltage | vs High-level output current | 5, 7 |
| V_{OL} | Low-level output voltage | vs Low-level output current | 6, 8 |
| Z_o | Output impedance | vs Frequency | 9 |
| I_{DD} | Supply current | vs Supply voltage | 10 |
| PSRR | Power supply rejection ratio | vs Frequency | 11 |
| CMRR | Common-mode rejection ratio | vs Frequency | 12 |
| V_n | Equivalent input noise voltage | vs Frequency | 13 |
| $V_{O(PP)}$ | Peak-to-peak output voltage | vs Frequency | 14, 15 |
| | Crosstalk | vs Frequency | 16 |
| | Differential voltage gain | vs Frequency | 17, 18 |
| | Phase | vs Frequency | 17, 18 |
| ϕ_m | Phase margin | vs Load capacitance | 19, 20 |
| | Gain margin | vs Load capacitance | 21, 22 |
| | Gain-bandwidth product | vs Supply voltage | 23 |
| SR | Slew rate | vs Supply voltage | 24 |
| | | vs Free-air temperature | 25, 26 |
| THD + N | Total harmonic distortion plus noise | vs Frequency | 27, 28 |
| | | vs Peak-to-peak output voltage | 29, 30 |
| | Large-signal follower pulse response | | 31, 32 |
| | Small-signal follower pulse response | | 33 |
| | Large-signal inverting pulse response | | 34, 35 |
| | Small-signal inverting pulse response | | 36 |
| | Shutdown forward isolation | vs Frequency | 37, 38 |
| | Shutdown reverse isolation | vs Frequency | 39, 40 |
| | Shutdown supply current | vs Supply voltage | 41 |
| | | vs Free-air temperature | 42 |
| | Shutdown pulse | | 43, 44 |

TLC080, TLC081, TLC082, TLC083, TLC084, TLC085, TLC08xA FAMILY OF WIDE-BANDWIDTH HIGH-OUTPUT-DRIVE SINGLE SUPPLY OPERATIONAL AMPLIFIERS

SLOS254E – JUNE 1999 – REVISED APRIL 2006

TYPICAL CHARACTERISTICS

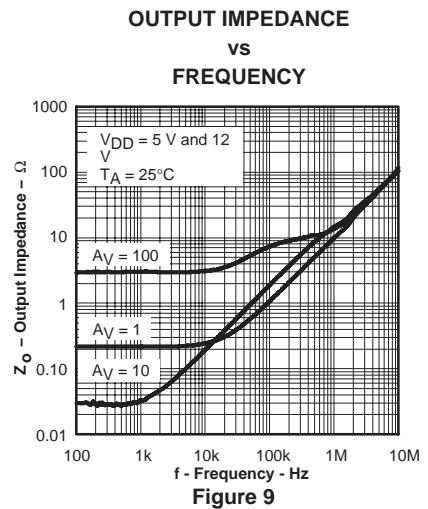
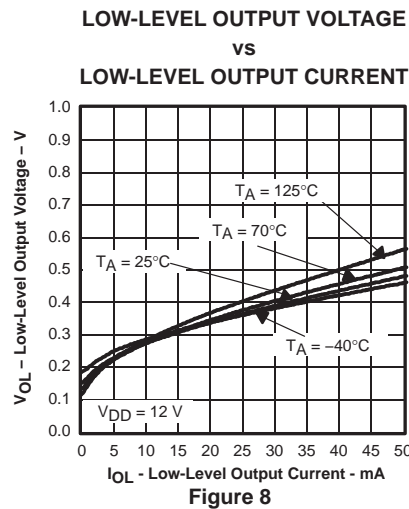
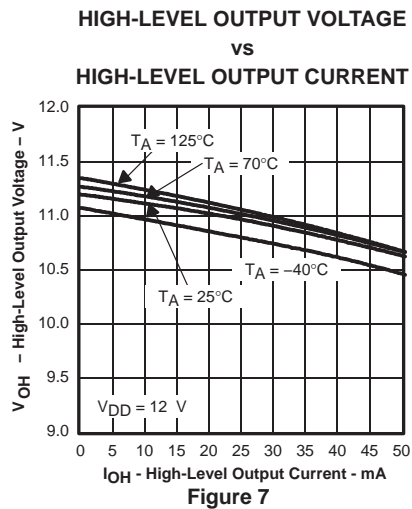
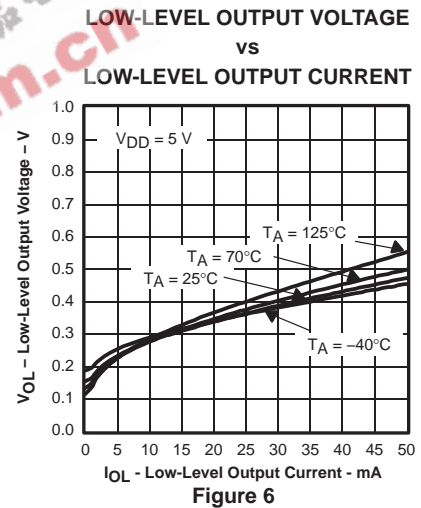
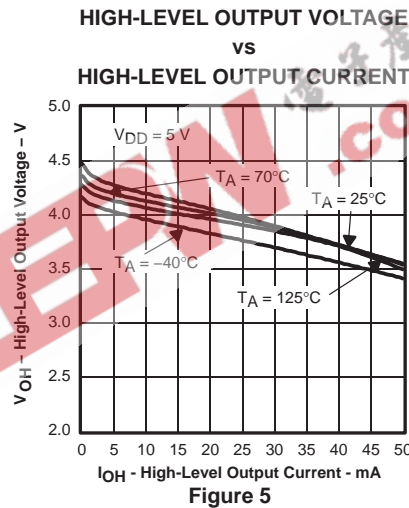
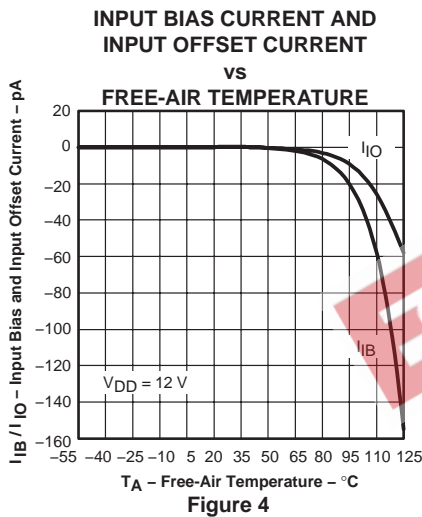
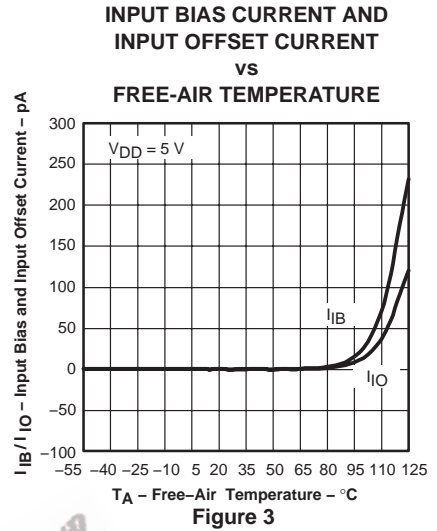
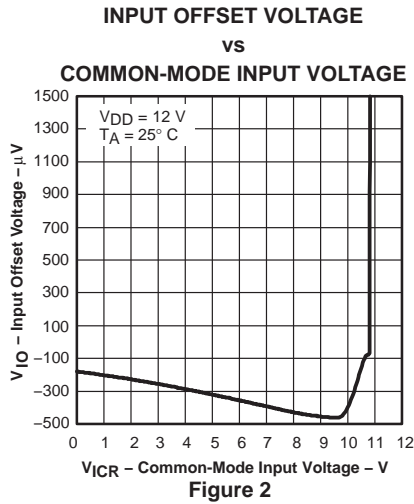
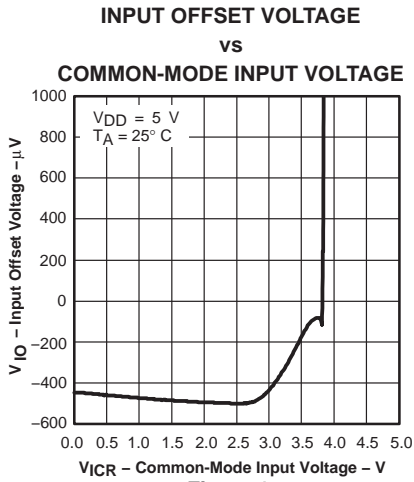

TLC080, TLC081, TLC082, TLC083, TLC084, TLC085, TLC08xA FAMILY OF WIDE-BANDWIDTH HIGH-OUTPUT-DRIVE SINGLE SUPPLY OPERATIONAL AMPLIFIERS

SLOS254E – JUNE 1999 – REVISED APRIL 2006

TYPICAL CHARACTERISTICS

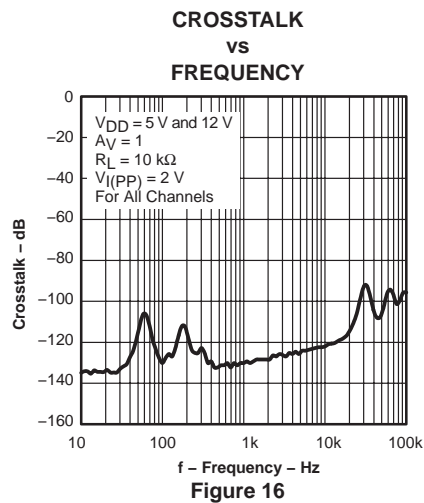
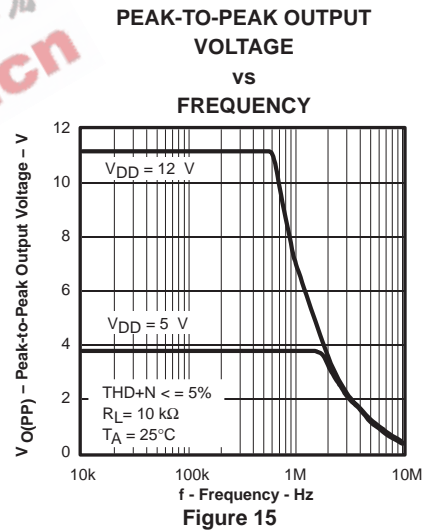
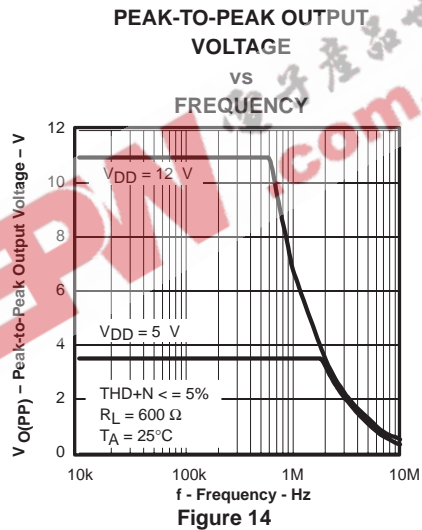
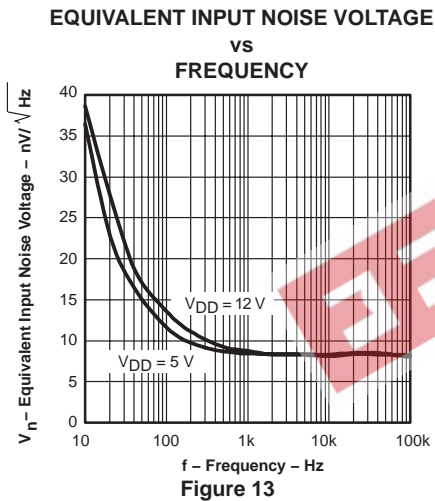
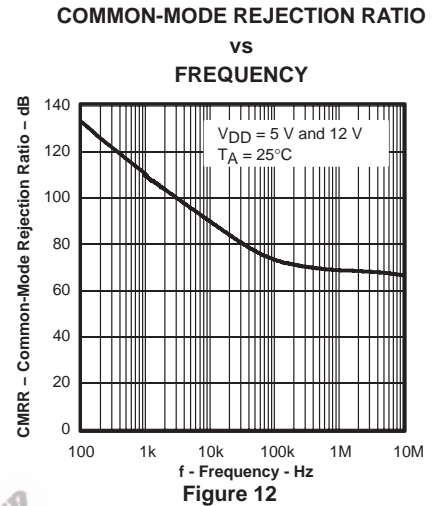
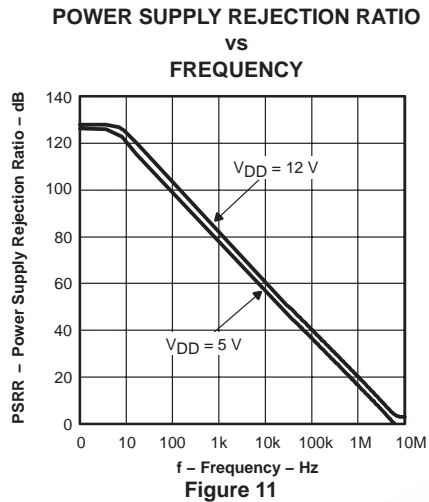
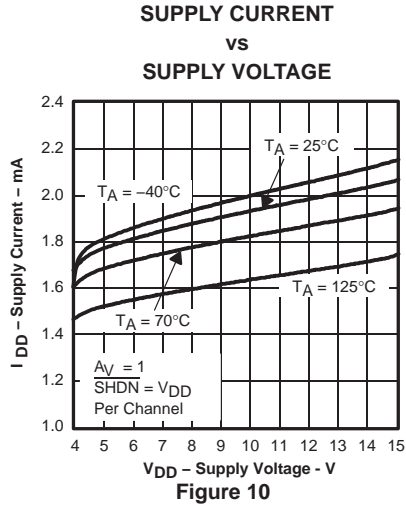

TLC080, TLC081, TLC082, TLC083, TLC084, TLC085, TLC08xA FAMILY OF WIDE-BANDWIDTH HIGH-OUTPUT-DRIVE SINGLE SUPPLY OPERATIONAL AMPLIFIERS

SLOS254E – JUNE 1999 – REVISED APRIL 2006

TYPICAL CHARACTERISTICS

DIFFERENTIAL VOLTAGE GAIN AND
PHASE
VS
FREQUENCY

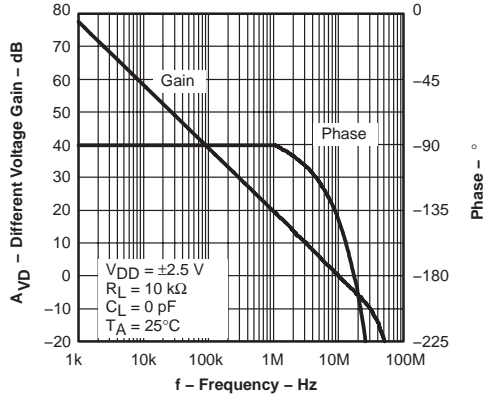

Figure 17

DIFFERENTIAL VOLTAGE GAIN AND
PHASE
VS
FREQUENCY

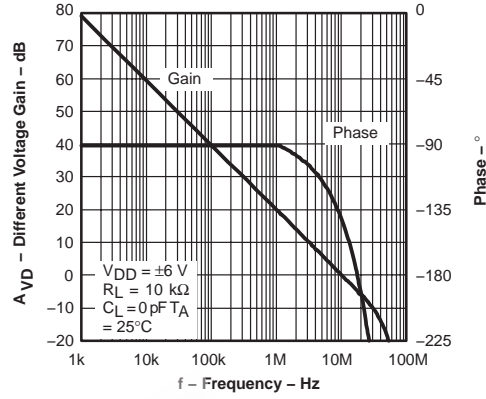

Figure 18

PHASE MARGIN
VS
LOAD CAPACITANCE

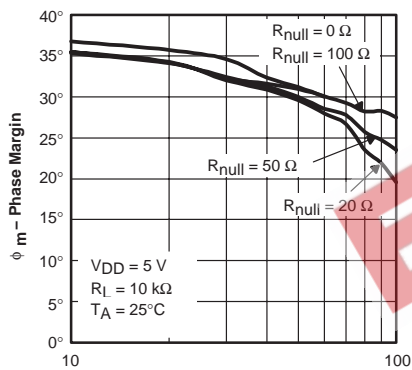

Figure 19

PHASE MARGIN
VS
LOAD CAPACITANCE

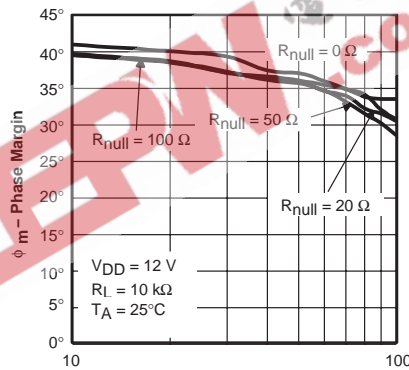

Figure 20

GAIN MARGIN
VS
LOAD CAPACITANCE

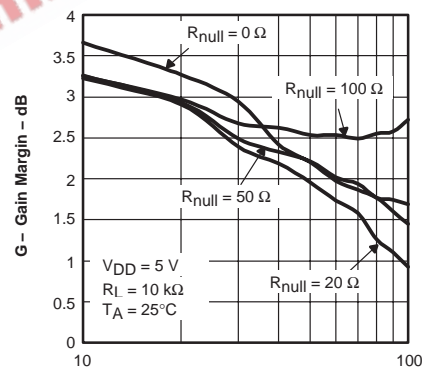

Figure 21

GAIN MARGIN
VS
LOAD CAPACITANCE

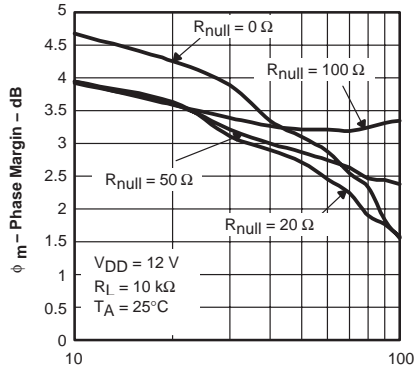

Figure 22

GAIN BANDWIDTH PRODUCT
VS
SUPPLY VOLTAGE

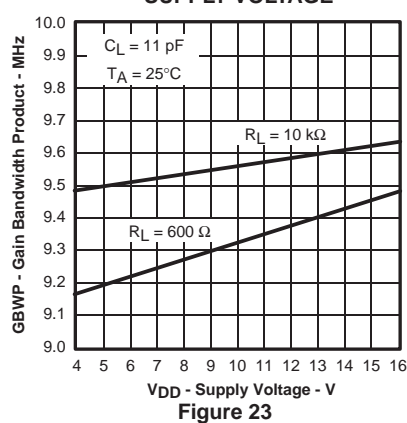

Figure 23

SLEW RATE
VS
SUPPLY VOLTAGE

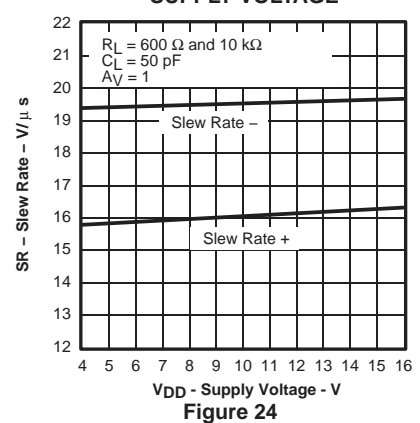
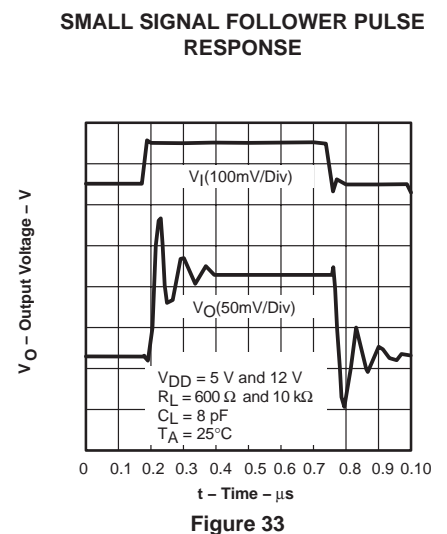
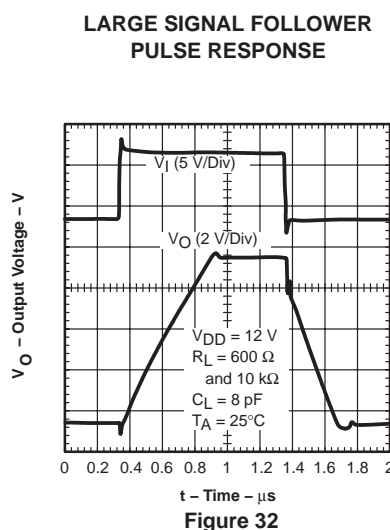
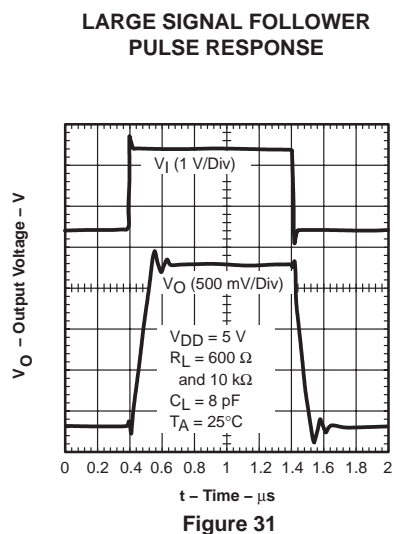
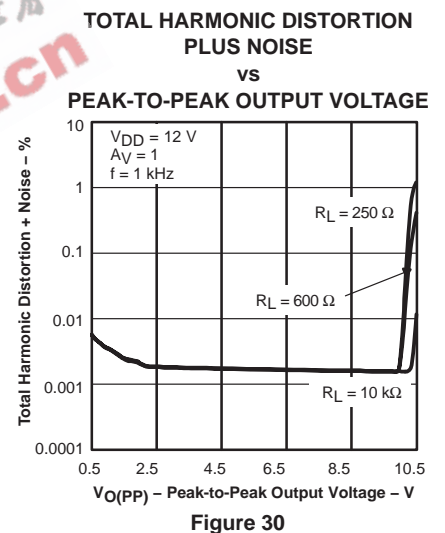
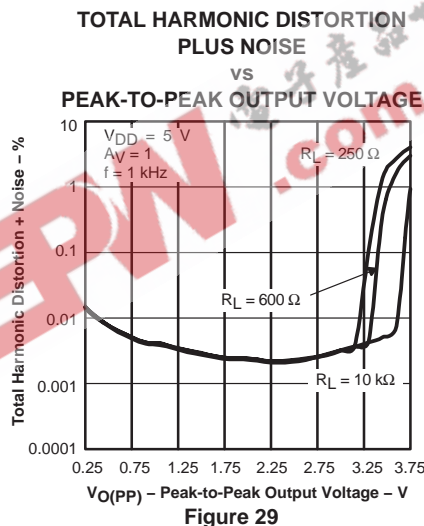
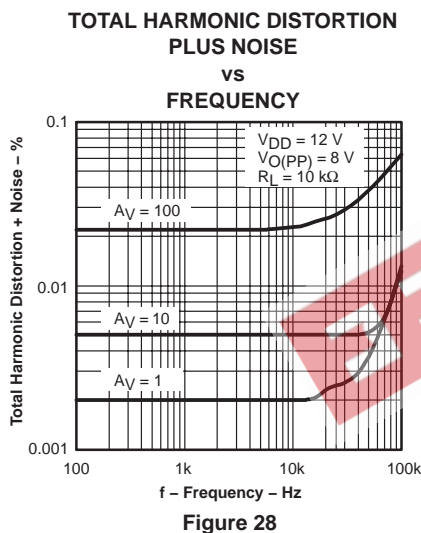
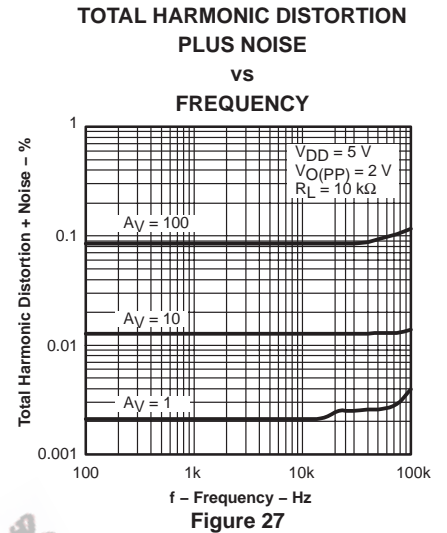
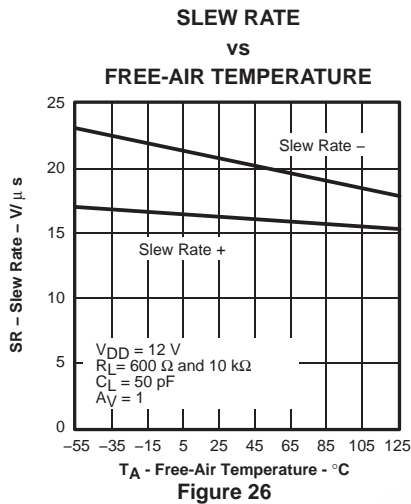
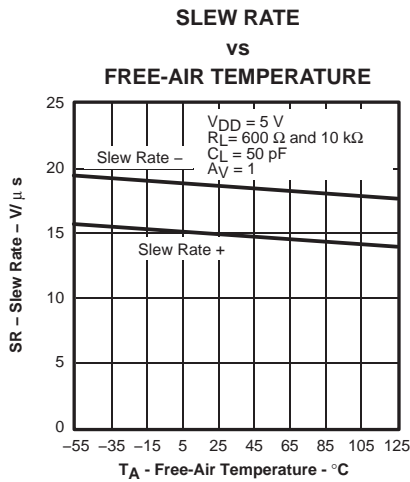

Figure 24

TLC080, TLC081, TLC082, TLC083, TLC084, TLC085, TLC08xA FAMILY OF WIDE-BANDWIDTH HIGH-OUTPUT-DRIVE SINGLE SUPPLY OPERATIONAL AMPLIFIERS

SLOS254E – JUNE 1999 – REVISED APRIL 2006

TYPICAL CHARACTERISTICS



TLC080, TLC081, TLC082, TLC083, TLC084, TLC085, TLC08xA FAMILY OF WIDE-BANDWIDTH HIGH-OUTPUT-DRIVE SINGLE SUPPLY OPERATIONAL AMPLIFIERS

SLOS254E – JUNE 1999 – REVISED APRIL 2006

TYPICAL CHARACTERISTICS

**LARGE SIGNAL INVERTING
PULSE RESPONSE**

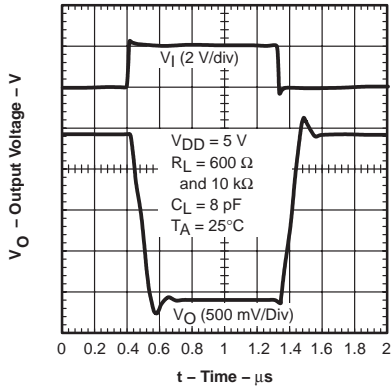

Figure 34

**LARGE SIGNAL INVERTING
PULSE RESPONSE**

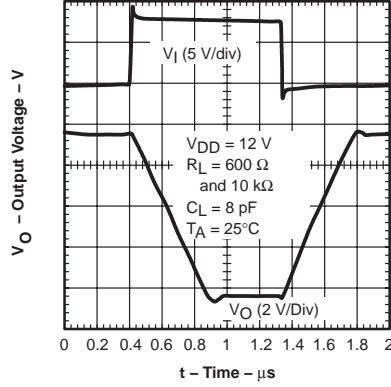

Figure 35

**SMALL SIGNAL INVERTING
PULSE RESPONSE**

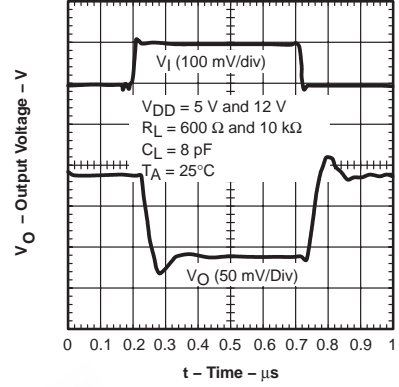

Figure 36

**SHUTDOWN FORWARD
ISOLATION
VS
FREQUENCY**

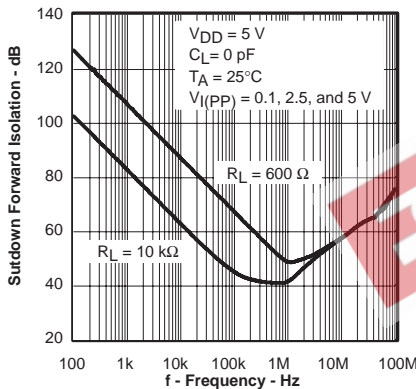

Figure 37

**SHUTDOWN FORWARD
ISOLATION
VS
FREQUENCY**

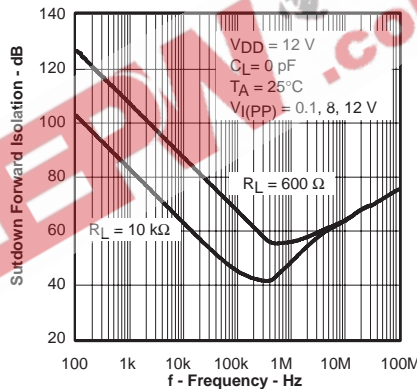

Figure 38

**SHUTDOWN REVERSE
ISOLATION
VS
FREQUENCY**

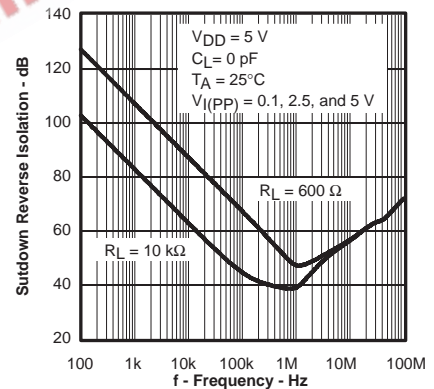

Figure 39

**SHUTDOWN REVERSE
ISOLATION
VS
FREQUENCY**

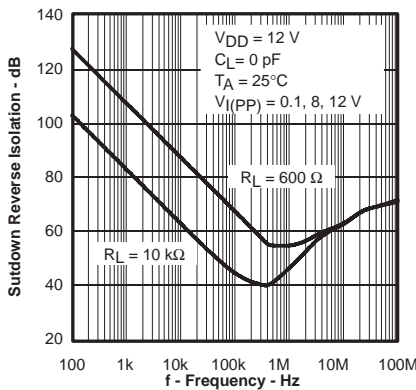

Figure 40

**SHUTDOWN SUPPLY CURRENT
VS
SUPPLY VOLTAGE**

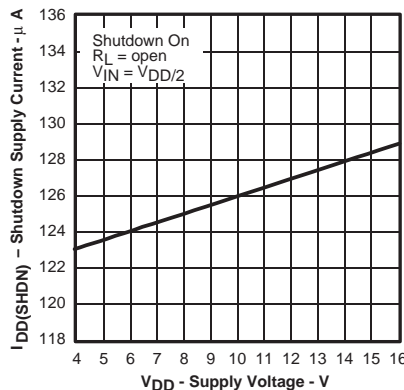

Figure 41

**SHUTDOWN SUPPLY CURRENT
VS
FREE-AIR TEMPERATURE**

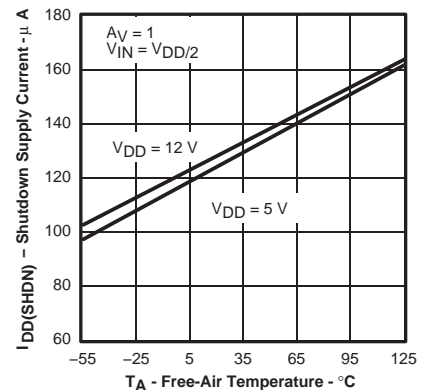
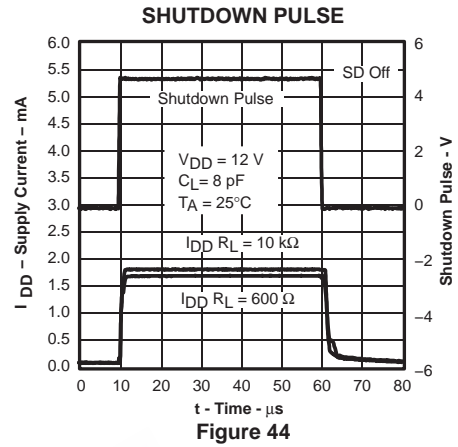
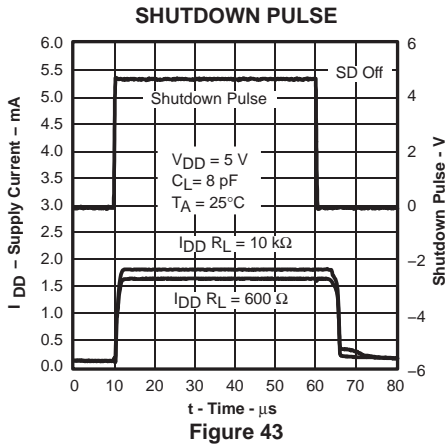

Figure 42

TLC080, TLC081, TLC082, TLC083, TLC084, TLC085, TLC08xA
FAMILY OF WIDE-BANDWIDTH HIGH-OUTPUT-DRIVE SINGLE SUPPLY
OPERATIONAL AMPLIFIERS
 SLOS254E – JUNE 1999 – REVISED APRIL 2006

TYPICAL CHARACTERISTICS



PARAMETER MEASUREMENT INFORMATION

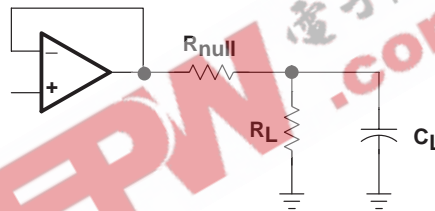

APPLICATION INFORMATION

input offset voltage null circuit

The TLC080 and TLC081 has an input offset nulling function. Refer to Figure 46 for the diagram.

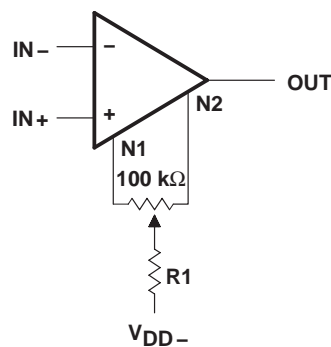

NOTE A: R1 = 5.6 kΩ for offset voltage adjustment of ±10 mV.
 R1 = 20 kΩ for offset voltage adjustment of ±3 mV.

TLC080, TLC081, TLC082, TLC083, TLC084, TLC085, TLC08xA FAMILY OF WIDE-BANDWIDTH HIGH-OUTPUT-DRIVE SINGLE SUPPLY OPERATIONAL AMPLIFIERS

SLOS254E – JUNE 1999 – REVISED APRIL 2006

APPLICATION INFORMATION

driving a capacitive load

When the amplifier is configured in this manner, capacitive loading directly on the output will decrease the device's phase margin leading to high frequency ringing or oscillations. Therefore, for capacitive loads of greater than 10 pF, it is recommended that a resistor be placed in series (R_{NULL}) with the output of the amplifier, as shown in Figure 47. A minimum value of 20 Ω should work well for most applications.

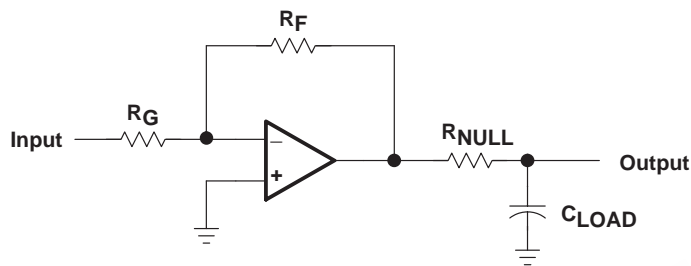

Figure 47. Driving a Capacitive Load

offset voltage

The output offset voltage, (V_{OO}) is the sum of the input offset voltage (V_{IO}) and both input bias currents (I_{IB}) times the corresponding gains. The following schematic and formula can be used to calculate the output offset voltage:

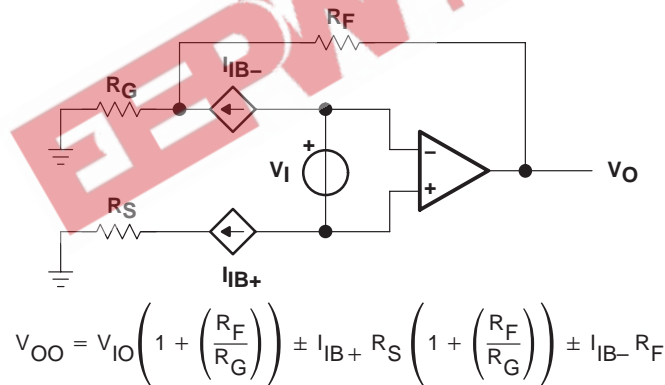

Figure 48. Output Offset Voltage Model

TLC080, TLC081, TLC082, TLC083, TLC084, TLC085, TLC08xA FAMILY OF WIDE-BANDWIDTH HIGH-OUTPUT-DRIVE SINGLE SUPPLY OPERATIONAL AMPLIFIERS

SLOS254E – JUNE 1999 – REVISED APRIL 2006

APPLICATION INFORMATION

high speed CMOS input amplifiers

The TLC08x is a family of high-speed low-noise CMOS input operational amplifiers that has an input capacitance of the order of 20 pF. Any resistor used in the feedback path adds a pole in the transfer function equivalent to the input capacitance multiplied by the combination of source resistance and feedback resistance. For example, a gain of -10 , a source resistance of $1\text{ k}\Omega$, and a feedback resistance of $10\text{ k}\Omega$ add an additional pole at approximately 8 MHz. This is more apparent with CMOS amplifiers than bipolar amplifiers due to their greater input capacitance.

This is of little consequence on slower CMOS amplifiers, as this pole normally occurs at frequencies above their unity-gain bandwidth. However, the TLC08x with its 10-MHz bandwidth means that this pole normally occurs at frequencies where there is on the order of 5dB gain left and the phase shift adds considerably.

The effect of this pole is the strongest with large feedback resistances at small closed loop gains. As the feedback resistance is increased, the gain peaking increases at a lower frequency and the 180° phase shift crossover point also moves down in frequency, decreasing the phase margin.

For the TLC08x, the maximum feedback resistor recommended is $5\text{ k}\Omega$; larger resistances can be used but a capacitor in parallel with the feedback resistor is recommended to counter the effects of the input capacitance pole.

The TLC083 with a 1-V step response has an 80% overshoot with a natural frequency of 3.5 MHz when configured as a unity gain buffer and with a $10\text{-k}\Omega$ feedback resistor. By adding a 10-pF capacitor in parallel with the feedback resistor, the overshoot is reduced to 40% and eliminates the natural frequency, resulting in a much faster settling time (see Figure 49). The 10-pF capacitor was chosen for convenience only.

Load capacitance had little effect on these measurements due to the excellent output drive capability of the TLC08x.

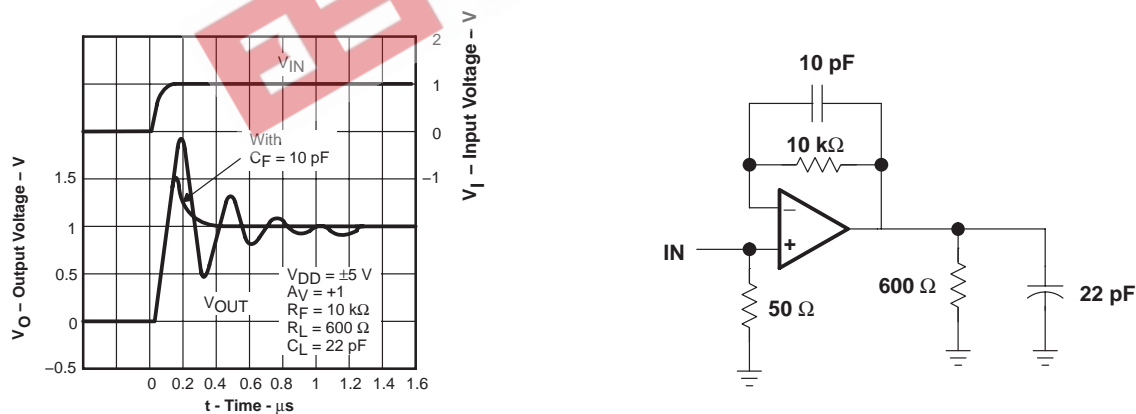

Figure 49. 1-V Step Response

TLC080, TLC081, TLC082, TLC083, TLC084, TLC085, TLC08xA FAMILY OF WIDE-BANDWIDTH HIGH-OUTPUT-DRIVE SINGLE SUPPLY OPERATIONAL AMPLIFIERS

SLOS254E – JUNE 1999 – REVISED APRIL 2006

APPLICATION INFORMATION

general configurations

When receiving low-level signals, limiting the bandwidth of the incoming signals into the system is often required. The simplest way to accomplish this is to place an RC filter at the noninverting terminal of the amplifier (see Figure 50).

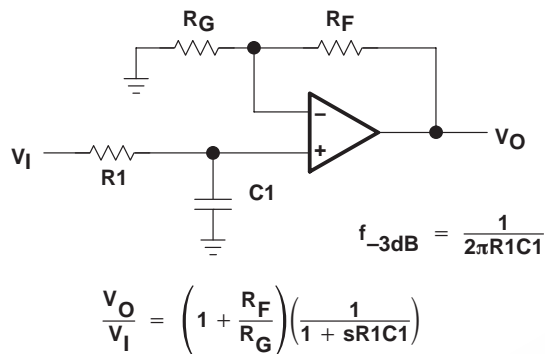

Figure 50. Single-Pole Low-Pass Filter

If even more attenuation is needed, a multiple pole filter is required. The Sallen-Key filter can be used for this task. For best results, the amplifier should have a bandwidth that is 8 to 10 times the filter frequency bandwidth. Failure to do this can result in phase shift of the amplifier.

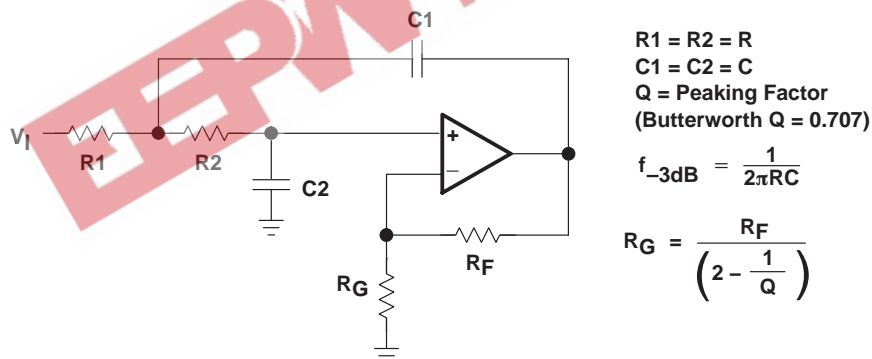

Figure 51. 2-Pole Low-Pass Sallen-Key Filter

TLC080, TLC081, TLC082, TLC083, TLC084, TLC085, TLC08xA FAMILY OF WIDE-BANDWIDTH HIGH-OUTPUT-DRIVE SINGLE SUPPLY OPERATIONAL AMPLIFIERS

SLOS254E – JUNE 1999 – REVISED APRIL 2006

APPLICATION INFORMATION

shutdown function

Three members of the TLC08x family (TLC080/3/5) have a shutdown terminal ($\overline{\text{SHDN}}$) for conserving battery life in portable applications. When the shutdown terminal is tied low, the supply current is reduced to 125 $\mu\text{A}/\text{channel}$, the amplifier is disabled, and the outputs are placed in a high-impedance mode. To enable the amplifier, the shutdown terminal can either be left floating or pulled high. When the shutdown terminal is left floating, care should be taken to ensure that parasitic leakage current at the shutdown terminal does not inadvertently place the operational amplifier into shutdown. The shutdown terminal threshold is always referenced to the voltage on the GND terminal of the device. Therefore, when operating the device with split supply voltages (e.g. $\pm 2.5\text{ V}$), the shutdown terminal needs to be pulled to $V_{\text{DD-}}$ (not system ground) to disable the operational amplifier.

The amplifier's output with a shutdown pulse is shown in Figure 43 and Figure 44. The amplifier is powered with a single 5-V supply and is configured as noninverting with a gain of 5. The amplifier turnon and turnoff times are measured from the 50% point of the shutdown pulse to the 50% point of the output waveform. The times for the single, dual, and quad are listed in the data tables.

Figure 37 through Figure 40 show the amplifier's forward and reverse isolation in shutdown. The operational amplifier is configured as a voltage follower ($A_V = 1$). The isolation performance is plotted across frequency using 0.1 V_{PP} , 2.5 V_{PP} , and 5 V_{PP} input signals at $\pm 2.5\text{ V}$ supplies and 0.1 V_{PP} , 8 V_{PP} , and 12 V_{PP} input signals at $\pm 6\text{ V}$ supplies.

circuit layout considerations

To achieve the levels of high performance of the TLC08x, follow proper printed-circuit board design techniques. A general set of guidelines is given in the following.

- Ground planes – It is highly recommended that a ground plane be used on the board to provide all components with a low inductive ground connection. However, in the areas of the amplifier inputs and output, the ground plane can be removed to minimize the stray capacitance.
- Proper power supply decoupling – Use a 6.8- μF tantalum capacitor in parallel with a 0.1- μF ceramic capacitor on each supply terminal. It may be possible to share the tantalum among several amplifiers depending on the application, but a 0.1- μF ceramic capacitor should always be used on the supply terminal of every amplifier. In addition, the 0.1- μF capacitor should be placed as close as possible to the supply terminal. As this distance increases, the inductance in the connecting trace makes the capacitor less effective. The designer should strive for distances of less than 0.1 inches between the device power terminals and the ceramic capacitors.
- Sockets – Sockets can be used but are not recommended. The additional lead inductance in the socket pins will often lead to stability problems. Surface-mount packages soldered directly to the printed-circuit board is the best implementation.
- Short trace runs/compact part placements – Optimum high performance is achieved when stray series inductance has been minimized. To realize this, the circuit layout should be made as compact as possible, thereby minimizing the length of all trace runs. Particular attention should be paid to the inverting input of the amplifier. Its length should be kept as short as possible. This will help to minimize stray capacitance at the input of the amplifier.
- Surface-mount passive components – Using surface-mount passive components is recommended for high performance amplifier circuits for several reasons. First, because of the extremely low lead inductance of surface-mount components, the problem with stray series inductance is greatly reduced. Second, the small size of surface-mount components naturally leads to a more compact layout thereby minimizing both stray inductance and capacitance. If leaded components are used, it is recommended that the lead lengths be kept as short as possible.

TLC080, TLC081, TLC082, TLC083, TLC084, TLC085, TLC08xA FAMILY OF WIDE-BANDWIDTH HIGH-OUTPUT-DRIVE SINGLE SUPPLY OPERATIONAL AMPLIFIERS

SLOS254E – JUNE 1999 – REVISED APRIL 2006

APPLICATION INFORMATION

general PowerPAD design considerations

The TLC08x is available in a thermally-enhanced PowerPAD family of packages. These packages are constructed using a downset leadframe upon which the die is mounted [see Figure 52(a) and Figure 52(b)]. This arrangement results in the lead frame being exposed as a thermal pad on the underside of the package [see Figure 52(c)]. Because this thermal pad has direct thermal contact with the die, excellent thermal performance can be achieved by providing a good thermal path away from the thermal pad.

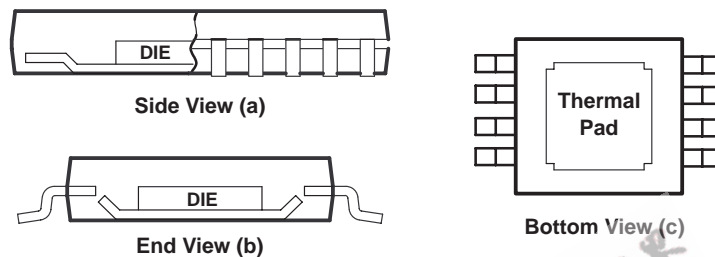

NOTE B: The thermal pad is electrically isolated from all terminals in the package.

Figure 52. Views of Thermally-Enhanced DGN Package

The PowerPAD package allows for both assembly and thermal management in one manufacturing operation. During the surface-mount solder operation (when the leads are being soldered), the thermal pad must be soldered to a copper area underneath the package. Through the use of thermal paths within this copper area, heat can be conducted away from the package into either a ground plane or other heat dissipating device. **Soldering the PowerPAD to the printed circuit board (PCB) is always required, even with applications that have low power dissipation.** This soldering provides the necessary thermal and mechanical connection between the lead frame die pad and the PCB.

Although there are many ways to properly heatsink the PowerPAD package, the following steps illustrate the recommended approach.

TLC080, TLC081, TLC082, TLC083, TLC084, TLC085, TLC08xA
FAMILY OF WIDE-BANDWIDTH HIGH-OUTPUT-DRIVE SINGLE SUPPLY
OPERATIONAL AMPLIFIERS

SLOS254E – JUNE 1999 – REVISED APRIL 2006

APPLICATION INFORMATION

general PowerPAD design considerations (continued)

The PowerPAD must be connected to the most negative supply voltage (GND pin potential) of the device.

1. Prepare the PCB with a top side etch pattern (see the landing patterns at the end of this data sheet). There should be etch for the leads as well as etch for the thermal pad.
2. Place five holes (dual) or nine holes (quad) in the area of the thermal pad. These holes should be 13 mils in diameter. Keep them small so that solder wicking through the holes is not a problem during reflow.
3. Additional vias may be placed anywhere along the thermal plane outside of the thermal pad area. This helps dissipate the heat generated by the TLC08x IC. These additional vias may be larger than the 13-mil diameter vias directly under the thermal pad. They can be larger because they are not in the thermal pad area to be soldered so that wicking is not a problem.
4. Connect all holes to the internal plane that is at the same potential as the ground pin of the device.
5. When connecting these holes to this internal plane, do not use the typical web or spoke via connection methodology. Web connections have a high thermal resistance connection that is useful for slowing the heat transfer during soldering operations. This makes the soldering of vias that have plane connections easier. In this application, however, low thermal resistance is desired for the most efficient heat transfer. Therefore, the holes under the TLC08x PowerPAD package should make their connection to the internal ground plane with a complete connection around the entire circumference of the plated-through hole.
6. The top-side solder mask should leave the terminals of the package and the thermal pad area with its five holes (dual) or nine holes (quad) exposed. The bottom-side solder mask should cover the five or nine holes of the thermal pad area. This prevents solder from being pulled away from the thermal pad area during the reflow process.
7. Apply solder paste to the exposed thermal pad area and all of the IC terminals.
8. With these preparatory steps in place, the TLC08x IC is simply placed in position and run through the solder reflow operation as any standard surface-mount component. This results in a part that is properly installed.

For a given θ_{JA} , the maximum power dissipation is shown in Figure 53 and is calculated by the following formula:

$$P_D = \left(\frac{T_{MAX} - T_A}{\theta_{JA}} \right)$$

Where:

- P_D = Maximum power dissipation of TLC08x IC (watts)
- T_{MAX} = Absolute maximum junction temperature (150°C)
- T_A = Free-ambient air temperature (°C)
- θ_{JA} = $\theta_{JC} + \theta_{CA}$
- θ_{JC} = Thermal coefficient from junction to case
- θ_{CA} = Thermal coefficient from case to ambient air (°C/W)

TLC080, TLC081, TLC082, TLC083, TLC084, TLC085, TLC08xA FAMILY OF WIDE-BANDWIDTH HIGH-OUTPUT-DRIVE SINGLE SUPPLY OPERATIONAL AMPLIFIERS

SLOS254E – JUNE 1999 – REVISED APRIL 2006

APPLICATION INFORMATION

general PowerPAD design considerations (continued)

MAXIMUM POWER DISSIPATION VS FREE-AIR TEMPERATURE

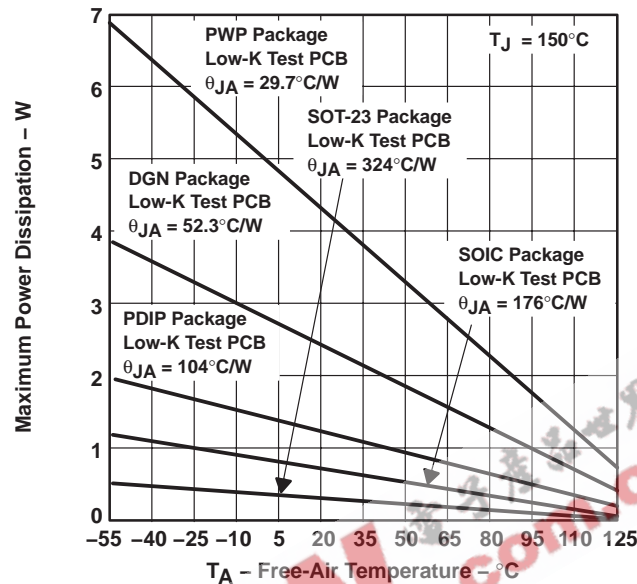

NOTE A: Results are with no air flow and using JEDEC Standard Low-K test PCB.

Figure 53. Maximum Power Dissipation vs Free-Air Temperature

The next consideration is the package constraints. The two sources of heat within an amplifier are quiescent power and output power. The designer should never forget about the quiescent heat generated within the device, especially multi-amplifier devices. Because these devices have linear output stages (Class A-B), most of the heat dissipation is at low output voltages with high output currents.

The other key factor when dealing with power dissipation is how the devices are mounted on the PCB. The PowerPAD devices are extremely useful for heat dissipation. But, the device should always be soldered to a copper plane to fully use the heat dissipation properties of the PowerPAD. The SOIC package, on the other hand, is highly dependent on how it is mounted on the PCB. As more trace and copper area is placed around the device, θ_{JA} decreases and the heat dissipation capability increases. The currents and voltages shown in these graphs are for the total package. For the dual or quad amplifier packages, the sum of the RMS output currents and voltages should be used to choose the proper package.

TLC080, TLC081, TLC082, TLC083, TLC084, TLC085, TLC08xA FAMILY OF WIDE-BANDWIDTH HIGH-OUTPUT-DRIVE SINGLE SUPPLY OPERATIONAL AMPLIFIERS

SLOS254E – JUNE 1999 – REVISED APRIL 2006

APPLICATION INFORMATION

macromodel information

Macromodel information provided was derived using Microsim *Parts*™, the model generation software used with Microsim *PSpice*™. The Boyle macromodel (see Note 1) and subcircuit in Figure 54 are generated using the TLC08x typical electrical and operating characteristics at $T_A = 25^\circ\text{C}$. Using this information, output simulations of the following key parameters can be generated to a tolerance of 20% (in most cases):

- Maximum positive output voltage swing
- Maximum negative output voltage swing
- Slew rate
- Quiescent power dissipation
- Input bias current
- Open-loop voltage amplification
- Unity-gain frequency
- Common-mode rejection ratio
- Phase margin
- DC output resistance
- AC output resistance
- Short-circuit output current limit

NOTE 2: G. R. Boyle, B. M. Cohn, D. O. Pederson, and J. E. Solomon, "Macromodeling of Integrated Circuit Operational Amplifiers," *IEEE Journal of Solid-State Circuits*, SC-9, 353 (1974).

EEPW 电子产品世界
.com.cn

PSpice and *Parts* are trademarks of MicroSim Corporation.

TLC080, TLC081, TLC082, TLC083, TLC084, TLC085, TLC08xA FAMILY OF WIDE-BANDWIDTH HIGH-OUTPUT-DRIVE SINGLE SUPPLY OPERATIONAL AMPLIFIERS

SLOS254E – JUNE 1999 – REVISED APRIL 2006

APPLICATION INFORMATION

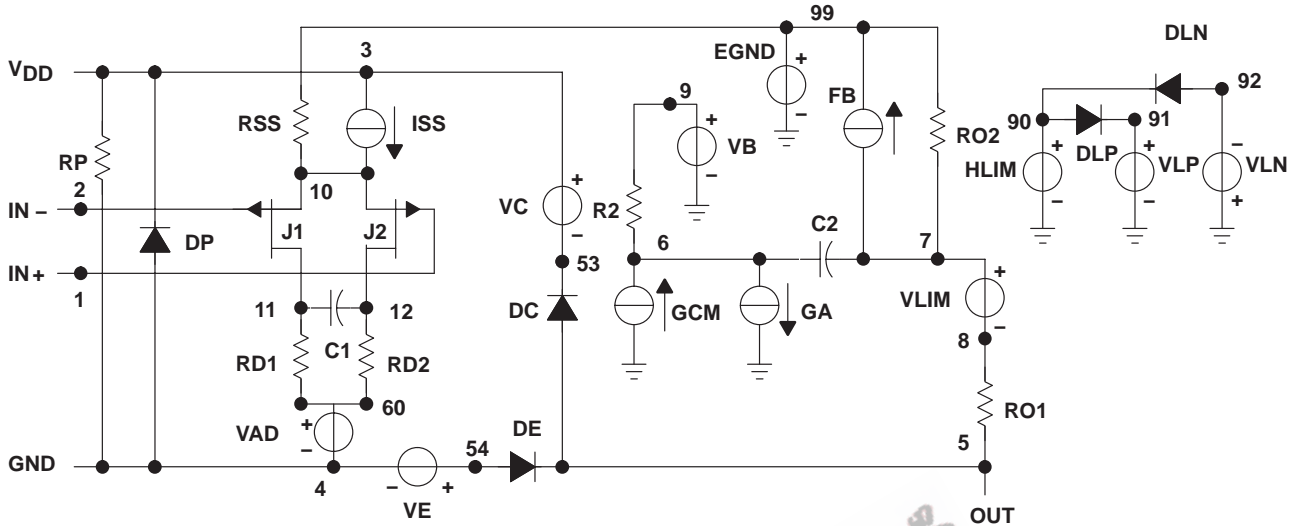

*DEVICE=TLC08X_5V, OPAMP, PJF, INT

* TLC08X_5V – 5V operational amplifier "macromodel" sub-circuit
* created using Parts release 8.0 on 12/16/99 at 14:03
* Parts is a MicroSim product.

* connections:

| | |
|--|-----------------------|
| | non-inverting input |
| | inverting input |
| | positive power supply |
| | negative power supply |
| | output |

.subckt TLC08X_5V 1 2 3 4 5

```

c1 11 12 4.6015E-12
c2 6 7 8.0000E-12
css 10 99 986.29E-15
dc 5 53 dy
de 54 5 dy
dlp 90 91 dx
dln 92 90 dx
dp 4 3 dx
egnd 99 0 poly(2) (3,0) (4,0) 0 .5 .5
fb 7 99 poly(5) vb vc ve vlp vln 0 13.984E6 -1E3 1E3
14E6 -14E6

```

```

ga 6 0 11 12 402.12E-6
gcm 0 6 10 99 1.5735E-6
ioff 0 6 dc 1.212E-6
iss 3 10 dc 130.40E-6
hlim 90 0 vlim 1K
j1 11 2 10 jx1
j2 12 1 10 jx2
r2 6 9 100.00E3
rd1 4 11 2.4868E3
rd2 4 12 2.4868E3
ro1 8 5 10
ro2 7 99 10
rp 3 4 2.8249E3
rss 10 99 1.5337E6
vb 9 0 dc 0
vc 3 53 dc 1.5537
ve 54 4 dc .84373
vlim 7 8 dc 0
vlp 91 0 dc 117.60
vln 0 92 dc 117.60
.model dx D(Is=800.00E-18)
.model dy D(Is=800.00E-18 Rs=1m Cjo=10p)
.model jx1 PJF(Is=80.000E-15 Beta=1.2401E-3 Vto=-1)
.model jx2 PJF(Is=80.000E-15 Beta=1.2401E-3 Vto=-1)
.ends

```

Figure 54. Boyle Macromodel and Subcircuit

TL7757 SUPPLY-VOLTAGE SUPERVISOR AND PRECISION VOLTAGE DETECTOR

SLVS0411 – SEPTEMBER 1991 – REVISED AUGUST 2003

- Power-On Reset Generator
- Automatic Reset Generation After Voltage Drop
- Low Standby Current . . . 20 μ A
- $\overline{\text{RESET}}$ Output Defined When V_{CC} Exceeds 1 V
- Precision Threshold Voltage
4.55 V \pm 120 mV
- High Output Sink Capability . . . 20 mA
- Comparator Hysteresis Prevents Erratic Resets

description/ordering information

The TL7757 is a supply-voltage supervisor designed for use in microcomputer and microprocessor systems. The supervisor monitors the supply voltage for undervoltage conditions. During power up, when the supply voltage, V_{CC} , attains a value approaching 1 V, the $\overline{\text{RESET}}$ output becomes active (low) to prevent undefined operation. If the supply voltage drops below threshold voltage level ($V_{\text{IT-}}$), the $\overline{\text{RESET}}$ output goes to the active (low) level until the supply undervoltage fault condition is eliminated.

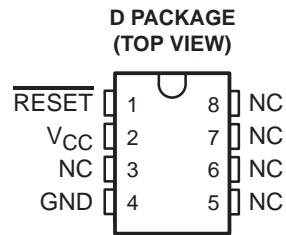

NC—No internal connection

**LP PACKAGE
(TOP VIEW)**



**PK PACKAGE
(TOP VIEW)**

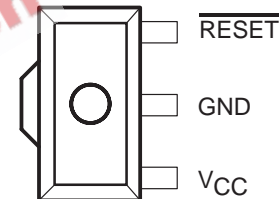

GND is in electrical contact with the tab.

ORDERING INFORMATION

| T_A | PACKAGE† | | ORDERABLE PART NUMBER | TOP-SIDE MARKING |
|---------------|--------------------|--------------|-----------------------|------------------|
| 0°C to 70°C | SOIC (D) | Tube of 75 | TL7757CD | 7757C |
| | | Reel of 2500 | TL7757CDR | |
| | SOT (PK) | Reel of 1000 | TL7757CPK | T7 |
| | TO226 / TO-92 (LP) | Bulk of 1000 | TL7757CLP | TL7757C |
| Reel of 2000 | | TL7757CLPR | | |
| -40°C to 85°C | SOIC (D) | Tube of 75 | TL7757ID | 7757I |
| | | Reel of 2500 | TL7757IDR | |
| | SOT (PK) | Reel of 1000 | TL7757IPK | 7I |
| | TO226 / TO-92 (LP) | Bulk of 1000 | TL7757ILP | TL7757I |
| | | Reel of 2000 | TL7757ILPR | |

† Package drawings, standard packing quantities, thermal data, symbolization, and PCB design guidelines are available at www.ti.com/sc/package.



Please be aware that an important notice concerning availability, standard warranty, and use in critical applications of Texas Instruments semiconductor products and disclaimers thereto appears at the end of this data sheet.

PRODUCTION DATA information is current as of publication date. Products conform to specifications per the terms of Texas Instruments standard warranty. Production processing does not necessarily include testing of all parameters.

**TEXAS
INSTRUMENTS**

POST OFFICE BOX 655303 • DALLAS, TEXAS 75265

Copyright © 2003, Texas Instruments Incorporated

TL7757 SUPPLY-VOLTAGE SUPERVISOR AND PRECISION VOLTAGE DETECTOR

SLVS0411 – SEPTEMBER 1991 – REVISED AUGUST 2003

equivalent schematic

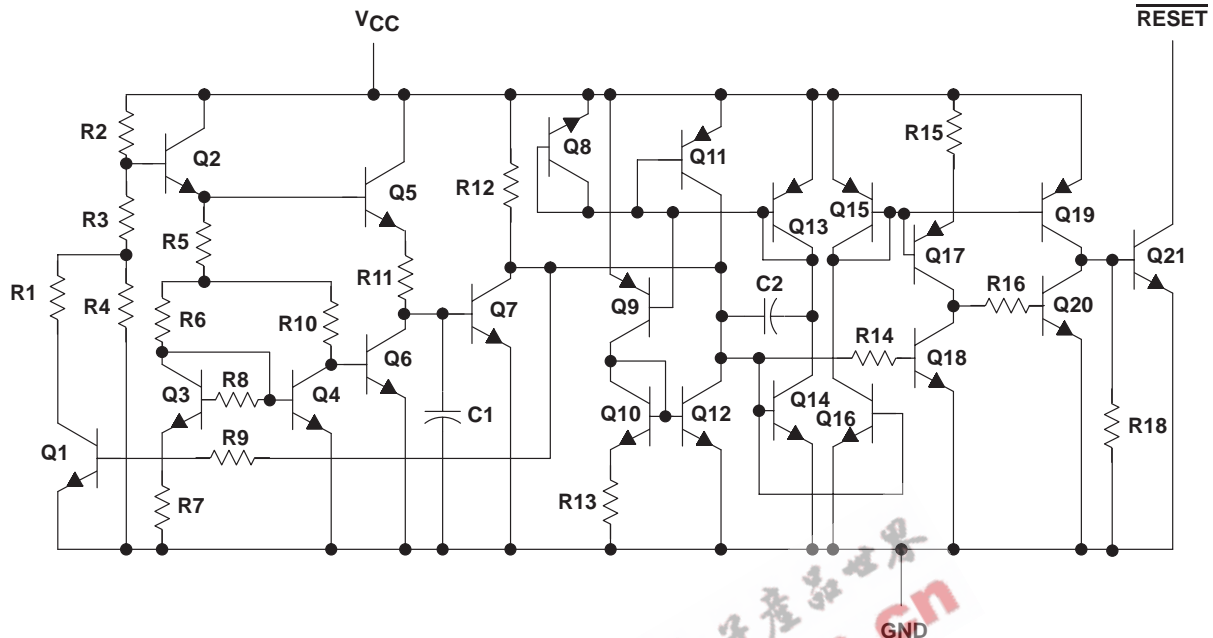

| ACTUAL DEVICE COMPONENT COUNT | |
|-------------------------------|----|
| Transistors | 27 |
| Resistors | 20 |
| Capacitors | 2 |

absolute maximum ratings over operating junction temperature range (unless otherwise noted)†

| | |
|---|----------------|
| Supply voltage range, V_{CC} (see Note 1) | -0.3 V to 20 V |
| Off-state output voltage range (see Note 1) | -0.3 V to 20 V |
| Output current, I_O | 30 mA |
| Package thermal impedance, θ_{JA} (see Notes 2 and 3): | |
| D package | 97°C/W |
| LP package | 140°C/W |
| PK package | 52°C/W |
| Operating virtual junction temperature, T_J | 150°C |
| Lead temperature 1,6 mm (1/16 inch) from case for 10 seconds | 260°C |
| Storage temperature range, T_{STG} | -65°C to 150°C |

† Stresses beyond those listed under “absolute maximum ratings” may cause permanent damage to the device. These are stress ratings only, and functional operation of the device at these or any other conditions beyond those indicated under “recommended operating conditions” is not implied. Exposure to absolute-maximum-rated conditions for extended periods may affect device reliability.

NOTES: 1. All voltage values are with respect to network terminal ground.

2. Maximum power dissipation is a function of $T_J(\max)$, θ_{JA} , and T_A . The maximum allowable power dissipation at any allowable ambient temperature is $P_D = (T_J(\max) - T_A)/\theta_{JA}$. Operating at the absolute maximum T_J of 150°C can affect reliability.

3. The package thermal impedance is calculated in accordance with JESD 51-7.

TL7757
SUPPLY-VOLTAGE SUPERVISOR
AND PRECISION VOLTAGE DETECTOR

SLVS0411 – SEPTEMBER 1991 – REVISED AUGUST 2003

recommended operating conditions

| | | MIN | MAX | UNIT | |
|-----------------|--------------------------------|---------|-----|------|----|
| V _{CC} | Supply voltage | 1 | 7 | V | |
| V _{OH} | High-level output voltage | | 15 | V | |
| I _{OL} | Low-level output current | | 20 | mA | |
| T _A | Operating free-air temperature | TL7757C | 0 | 70 | °C |
| | | TL7757I | -40 | 85 | |

electrical characteristics at specified free-air temperature

| PARAMETER | TEST CONDITIONS | T _A | TL7757C | | | UNIT |
|-------------------------------|---|--|-------------|------|------|------|
| | | | MIN | TYP | MAX | |
| V _{IT-} | Negative-going input threshold voltage at V _{CC} | 25°C | 4.43 | 4.55 | 4.67 | V |
| | | 0°C to 70°C | 4.4 | | 4.7 | |
| V _{hys} [†] | Hysteresis at V _{CC} | 25°C | 40 | 50 | 60 | mV |
| | | 0°C to 70°C | 30 | | 70 | |
| V _{OL} | Low-level output voltage | I _{OL} = 20 mA, V _{CC} = 4.3 V | 25°C | 0.4 | 0.8 | V |
| | | | 0°C to 70°C | | 0.8 | |
| I _{OH} | High-level output current | V _{CC} = 7 V, V _{OH} = 15 V, See Figure 1 | 25°C | | 1 | μA |
| | | | 0°C to 70°C | | 1 | |
| V _{res} [‡] | Power-up reset voltage | R _L = 2.2 kΩ, V _{CC} slew rate ≤ 5 V/μs | 25°C | 0.8 | 1 | V |
| | | | 0°C to 70°C | | 1.2 | |
| I _{CC} | Supply current | V _{CC} = 4.3 V | 25°C | 1400 | 2000 | μA |
| | | | 0°C to 70°C | | 2000 | |
| | | | 0°C to 70°C | | 40 | |

[†] This is the difference between positive-going input threshold voltage, V_{IT+}, and negative-going input threshold voltage, V_{IT-}.

[‡] This is the lowest voltage at which RESET becomes active.

switching characteristics at specified free-air temperature

| PARAMETER | TEST CONDITIONS | T _A | TL7757C | | | UNIT |
|---------------------|---|--|-------------|------|-----|------|
| | | | MIN | TYP | MAX | |
| t _{PLH} | Propagation delay time, low-to-high-level output | V _{CC} slew rate ≤ 5 V/μs, See Figures 2 and 3 | 25°C | 3.4 | 5 | μs |
| | | | 0°C to 70°C | | 5 | |
| t _{PHL} | Propagation delay time, high-to-low-level output | See Figures 2 and 3 | 25°C | 2 | 5 | μs |
| | | | 0°C to 70°C | | 5 | |
| t _r | Rise time | V _{CC} slew rate ≤ 5 V/μs, See Figures 2 and 3 | 25°C | 0.4 | 1 | μs |
| | | | 0°C to 70°C | | 1 | |
| t _f | Fall time | See Figures 2 and 3 | 25°C | 0.05 | 1 | μs |
| | | | 0°C to 70°C | | 1 | |
| t _{w(min)} | Minimum pulse duration at V _{CC} for output response | | 25°C | | 5 | μs |
| | | | 0°C to 70°C | | 5 | |

TL7757 SUPPLY-VOLTAGE SUPERVISOR AND PRECISION VOLTAGE DETECTOR

SLVS0411 – SEPTEMBER 1991 – REVISED AUGUST 2003

electrical characteristics at specified free-air temperature

| PARAMETER | TEST CONDITIONS | T _A | TL7757I | | | UNIT |
|--|--|----------------|---------|------|------|------|
| | | | MIN | TYP | MAX | |
| V _{IT-} Negative-going input threshold voltage at V _{CC} | | 25°C | 4.43 | 4.55 | 4.67 | V |
| | | -40°C to 85°C | 4.4 | | 4.7 | |
| V _{hys} [†] Hysteresis at V _{CC} | | 25°C | 40 | 50 | 60 | mV |
| | | -40°C to 85°C | 30 | | 70 | |
| V _{OL} Low-level output voltage | I _{OL} = 20 mA, V _{CC} = 4.3 V | 25°C | | 0.4 | 0.8 | V |
| | | -40°C to 85°C | | | 0.8 | |
| I _{OH} High-level output current | V _{CC} = 7 V, V _{OH} = 15 V, See Figure 1 | 25°C | | | 1 | μA |
| | | -40°C to 85°C | | | 1 | |
| V _{res} [‡] Power-up reset voltage | R _L = 2.2 kΩ, V _{CC} slew rate ≤ 5 V/μs | 25°C | | 0.8 | 1 | V |
| | | -40°C to 85°C | | | 1.2 | |
| I _{CC} Supply current | V _{CC} = 4.3 V | 25°C | | 1400 | 2000 | μA |
| | | -40°C to 85°C | | | 2100 | |
| | | -40°C to 85°C | | | 40 | |

[†] This is the difference between positive-going input threshold voltage, V_{IT+}, and negative-going input threshold voltage, V_{IT-}.

[‡] This is the lowest voltage at which RESET becomes active.

switching characteristics at specified free-air temperature

| PARAMETER | TEST CONDITIONS | T _A | TL7757I | | | UNIT |
|---|--|----------------|---------|------|-----|------|
| | | | MIN | TYP | MAX | |
| t _{PLH} Propagation delay time, low-to-high-level output | V _{CC} slew rate ≤ 5 V/μs, See Figures 2 and 3 | 25°C | | 3.4 | 5 | μs |
| | | -40°C to 85°C | | | 5 | |
| t _{PHL} Propagation delay time, high-to-low-level output | See Figures 2 and 3 | 25°C | | 2 | 5 | μs |
| | | -40°C to 85°C | | | 5 | |
| t _r Rise time | V _{CC} slew rate ≤ 5 V/μs, See Figures 2 and 3 | 25°C | | 0.4 | 1 | μs |
| | | -40°C to 85°C | | | 1 | |
| t _f Fall time | See Figures 2 and 3 | 25°C | | 0.05 | 1 | μs |
| | | -40°C to 85°C | | | 1 | |
| t _{w(min)} Minimum pulse duration at V _{CC} for output response | | 25°C | | | 5 | μs |
| | | -40°C to 85°C | | | 5 | |

PARAMETER MEASUREMENT INFORMATION

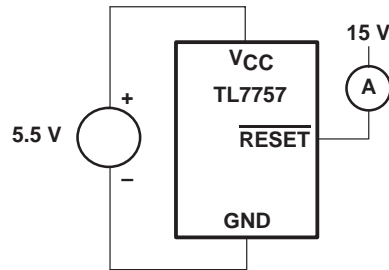
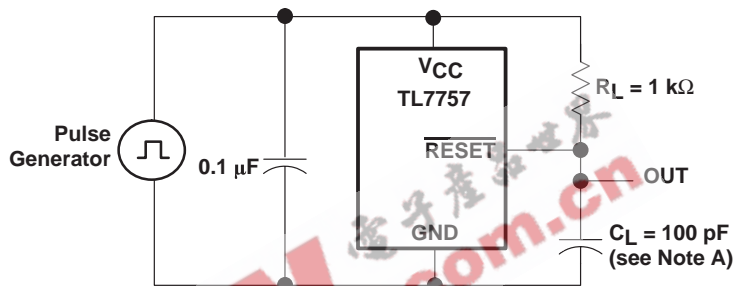
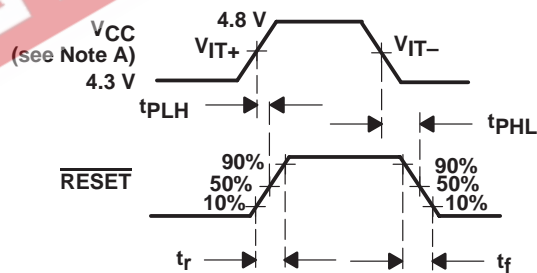

Figure 1. Test Circuit for Output Leakage Current



NOTE A: Includes jig and probe capacitance

Figure 2. Test Circuit for RESET Output Switching Characteristics



NOTE A: V_{CC} slew rate $\leq 5 \mu s$

Figure 3. Switching Diagram

TL7757
SUPPLY-VOLTAGE SUPERVISOR
AND PRECISION VOLTAGE DETECTOR
 SLVS0411 – SEPTEMBER 1991 – REVISED AUGUST 2003

TYPICAL CHARACTERISTICS†

Table of Graphs

| | | FIGURE |
|------------------|---|--------|
| V _{CC} | Supply voltage vs $\overline{\text{RESET}}$ output voltage | 4 |
| I _{CC} | Supply current vs Supply voltage | 5 |
| I _{CC} | Supply current vs Free-air temperature | 6 |
| V _{OL} | Low-level output voltage vs Low-level output current | 7 |
| V _{OL} | Low-level output voltage vs Free-air temperature | 8 |
| I _{OL} | Output current vs Supply voltage | 9 |
| V _{IT-} | Input threshold voltage (negative-going V _{CC}) vs Free-air temperature | 10 |
| V _{res} | Power-up reset voltage vs Free-air temperature | 11 |
| V _{res} | Power-up reset voltage and supply voltage vs Time | 12 |
| | Propagation delay time | 13 |

**SUPPLY VOLTAGE
 vs
 $\overline{\text{RESET}}$ OUTPUT VOLTAGE**

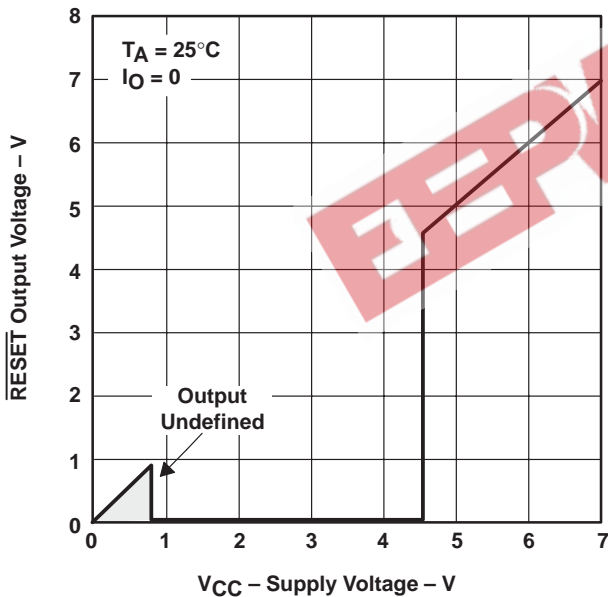

Figure 4

**SUPPLY CURRENT
 vs
 SUPPLY VOLTAGE**

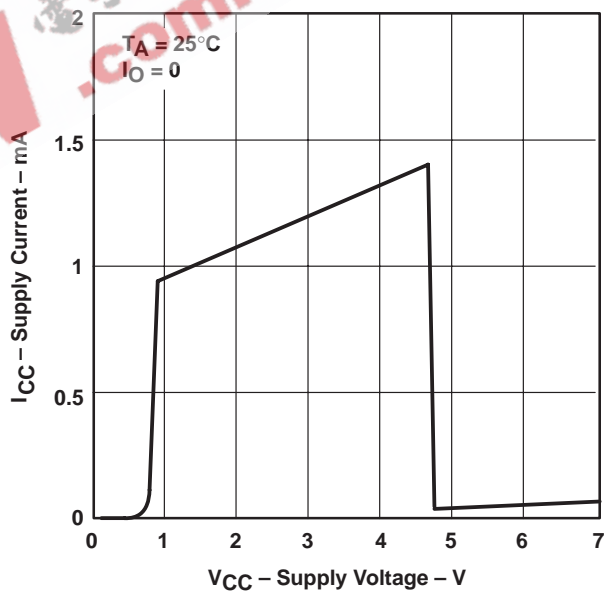

Figure 5

† Data at high and low temperatures are applicable only within the rated operating free-air temperature ranges of the various devices.

TYPICAL CHARACTERISTICS†

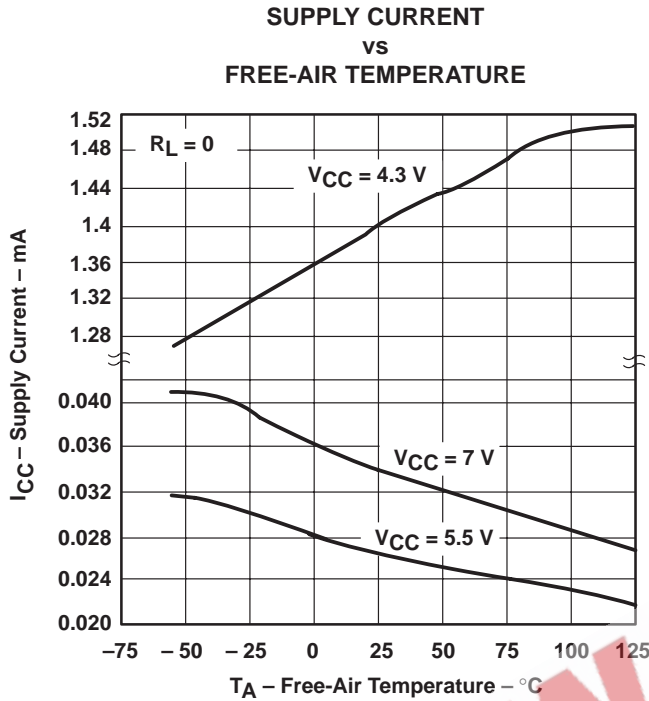

Figure 6

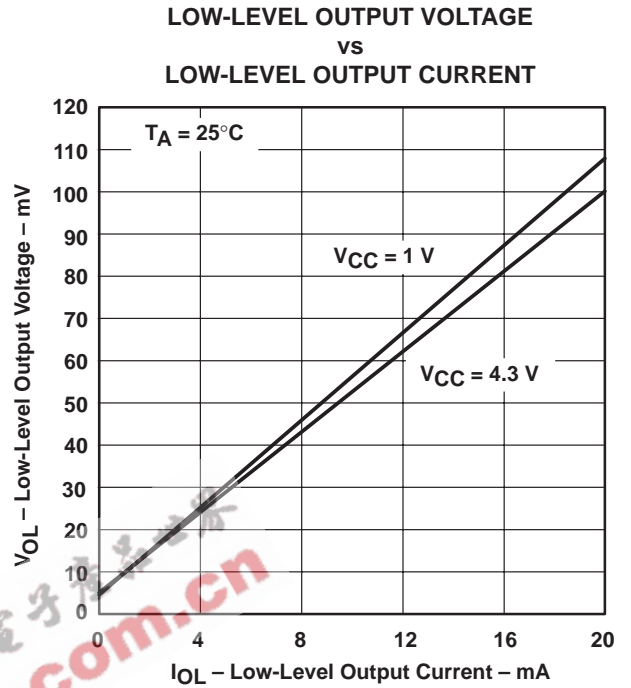

Figure 7

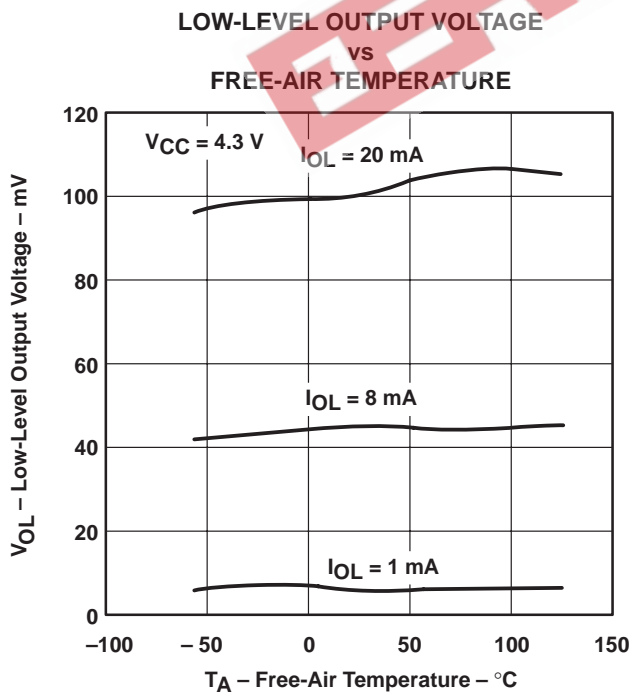

Figure 8

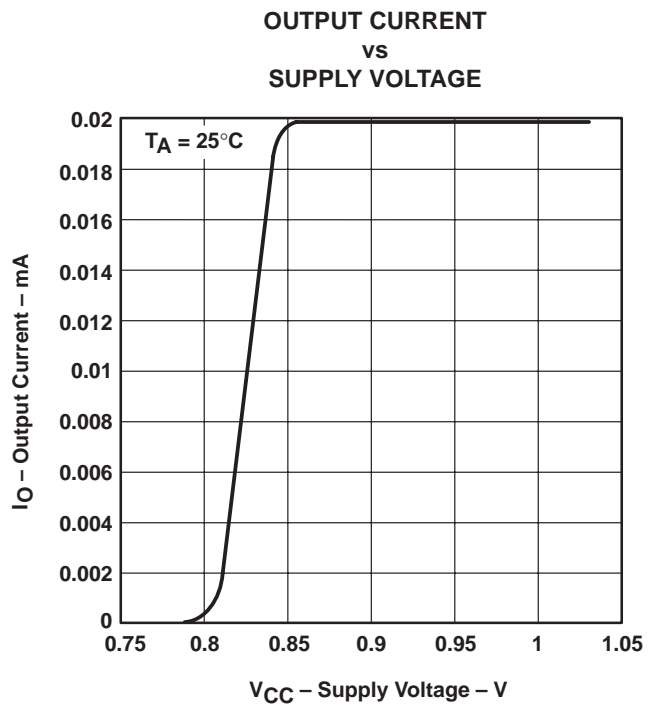

Figure 9

† Data at high and low temperatures are applicable only within the rated operating free-air temperature ranges of the various devices.

TL7757
SUPPLY-VOLTAGE SUPERVISOR
AND PRECISION VOLTAGE DETECTOR
 SLVS0411 – SEPTEMBER 1991 – REVISED AUGUST 2003

TYPICAL CHARACTERISTICS†

**INPUT THRESHOLD VOLTAGE
 (NEGATIVE-GOING V_{CC})
 vs
 FREE-AIR TEMPERATURE**

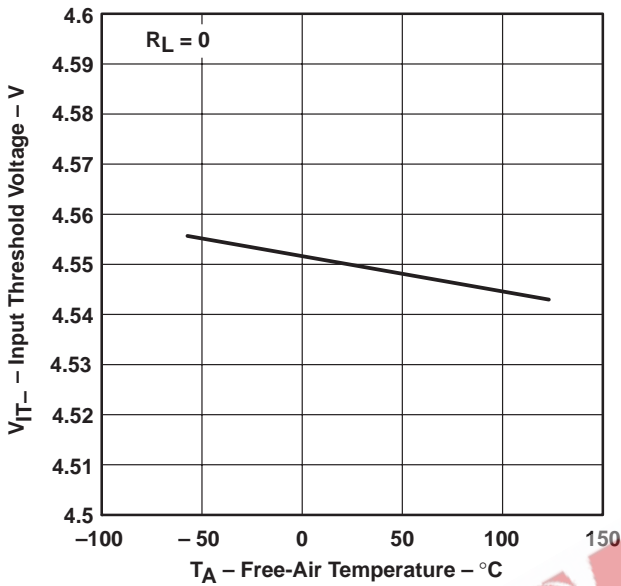

Figure 10

**POWER-UP RESET VOLTAGE
 vs
 FREE-AIR TEMPERATURE**

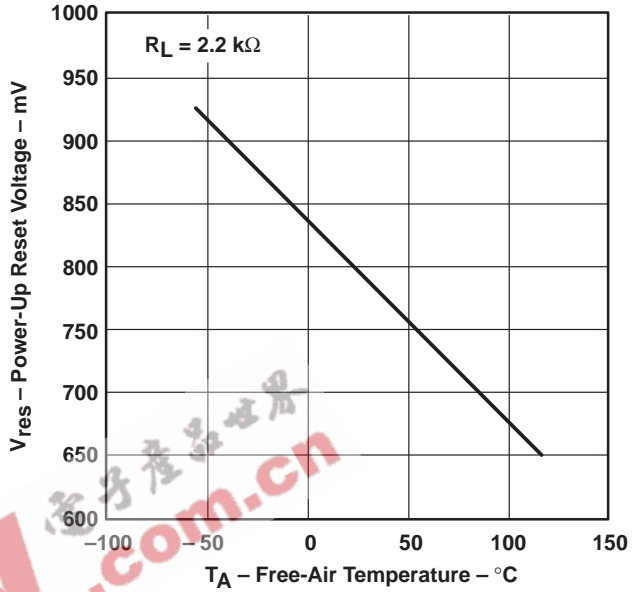

Figure 11

**POWER-UP RESET VOLTAGE
 AND SUPPLY VOLTAGE
 vs
 TIME**

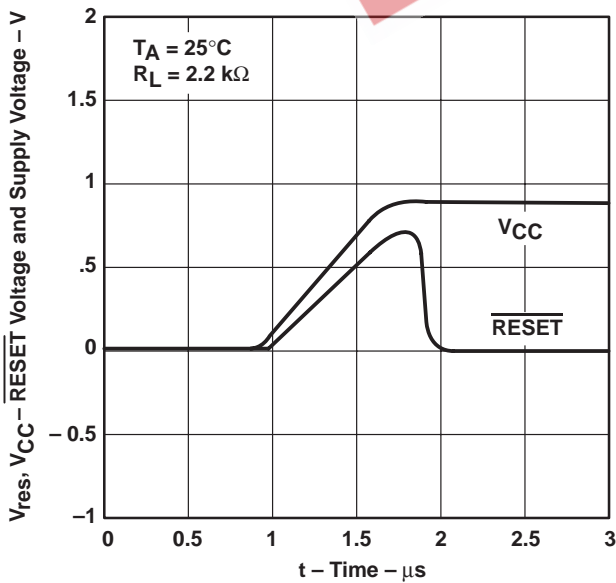

Figure 12

PROPAGATION DELAY TIME

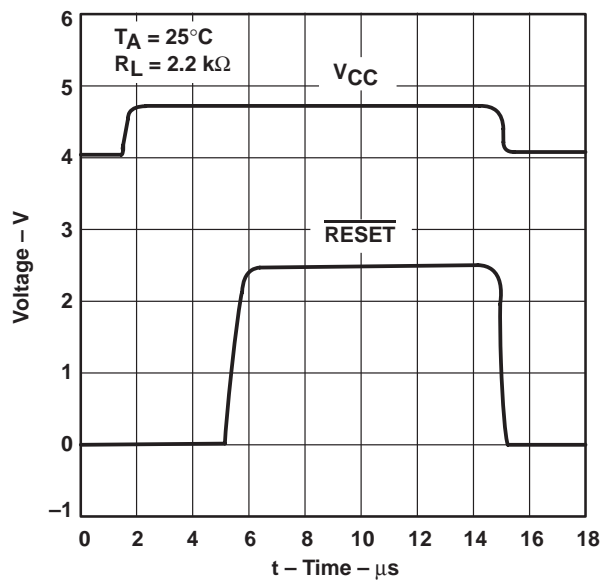
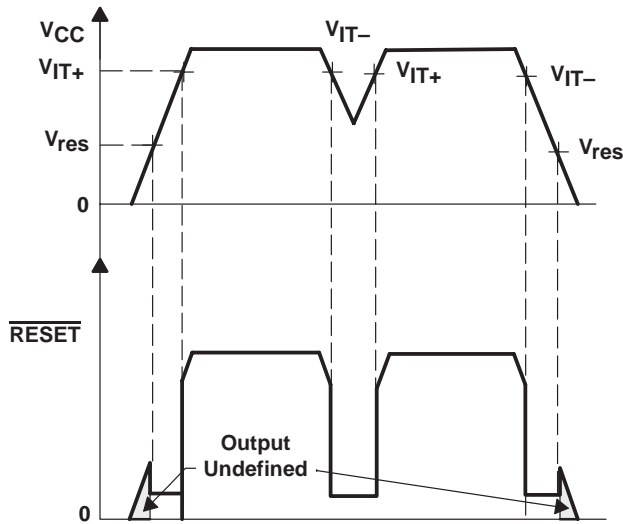

Figure 13

† Data at high and low temperatures are applicable only within the rated operating free-air temperature ranges of the various devices.

APPLICATION INFORMATION

TYPICAL TIMING DIAGRAM



TYPICAL APPLICATION DIAGRAM

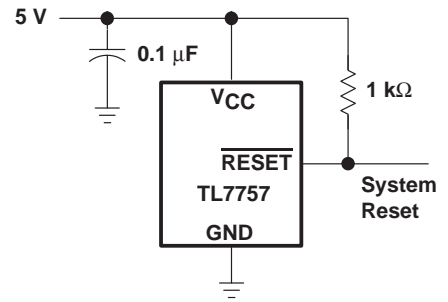

EEPW 电子产品世界 .com.cn

PACKAGING INFORMATION

| Orderable Device | Status ⁽¹⁾ | Package Type | Package Drawing | Pins | Package Qty | Eco Plan ⁽²⁾ | Lead/Ball Finish | MSL Peak Temp ⁽³⁾ |
|------------------|-----------------------|--------------|-----------------|------|-------------|-------------------------|------------------|------------------------------|
| TL7757CD | ACTIVE | SOIC | D | 8 | 75 | Green (RoHS & no Sb/Br) | CU NIPDAU | Level-1-260C-UNLIM |
| TL7757CDE4 | ACTIVE | SOIC | D | 8 | 75 | Green (RoHS & no Sb/Br) | CU NIPDAU | Level-1-260C-UNLIM |
| TL7757CDR | ACTIVE | SOIC | D | 8 | 2500 | Green (RoHS & no Sb/Br) | CU NIPDAU | Level-1-260C-UNLIM |
| TL7757CDRE4 | ACTIVE | SOIC | D | 8 | 2500 | Green (RoHS & no Sb/Br) | CU NIPDAU | Level-1-260C-UNLIM |
| TL7757CLP | ACTIVE | TO-92 | LP | 3 | 1000 | Pb-Free (RoHS) | CU SN | N / A for Pkg Type |
| TL7757CLPE3 | ACTIVE | TO-92 | LP | 3 | 1000 | Pb-Free (RoHS) | CU SN | N / A for Pkg Type |
| TL7757CLPR | ACTIVE | TO-92 | LP | 3 | 2000 | Pb-Free (RoHS) | CU SN | N / A for Pkg Type |
| TL7757CLPRE3 | ACTIVE | TO-92 | LP | 3 | 2000 | Pb-Free (RoHS) | CU SN | N / A for Pkg Type |
| TL7757CPK | ACTIVE | SOT-89 | PK | 3 | 1000 | Green (RoHS & no Sb/Br) | CU SN | Level-2-260C-1YEAR |
| TL7757CPKG3 | ACTIVE | SOT-89 | PK | 3 | 1000 | Green (RoHS & no Sb/Br) | CU SN | Level-2-260C-1YEAR |
| TL7757ID | ACTIVE | SOIC | D | 8 | 75 | Green (RoHS & no Sb/Br) | CU NIPDAU | Level-1-260C-UNLIM |
| TL7757IDE4 | ACTIVE | SOIC | D | 8 | 75 | Green (RoHS & no Sb/Br) | CU NIPDAU | Level-1-260C-UNLIM |
| TL7757IDR | ACTIVE | SOIC | D | 8 | 2500 | Green (RoHS & no Sb/Br) | CU NIPDAU | Level-1-260C-UNLIM |
| TL7757IDRE4 | ACTIVE | SOIC | D | 8 | 2500 | Green (RoHS & no Sb/Br) | CU NIPDAU | Level-1-260C-UNLIM |
| TL7757ILP | ACTIVE | TO-92 | LP | 3 | 1000 | Pb-Free (RoHS) | CU SN | N / A for Pkg Type |
| TL7757ILPE3 | ACTIVE | TO-92 | LP | 3 | 1000 | Pb-Free (RoHS) | CU SN | N / A for Pkg Type |
| TL7757ILPR | ACTIVE | TO-92 | LP | 3 | 2000 | Pb-Free (RoHS) | CU SN | N / A for Pkg Type |
| TL7757ILPRE3 | ACTIVE | TO-92 | LP | 3 | 2000 | Pb-Free (RoHS) | CU SN | N / A for Pkg Type |
| TL7757IPK | ACTIVE | SOT-89 | PK | 3 | 1000 | Green (RoHS & no Sb/Br) | CU SN | Level-2-260C-1YEAR |
| TL7757IPKG3 | ACTIVE | SOT-89 | PK | 3 | 1000 | Green (RoHS & no Sb/Br) | CU SN | Level-2-260C-1YEAR |
| TL7757MD | OBSOLETE | SOIC | D | 8 | | TBD | Call TI | Call TI |
| TL7757MDR | OBSOLETE | SOIC | D | 8 | | TBD | Call TI | Call TI |
| TL7757MLP | OBSOLETE | TO-92 | LP | 3 | | TBD | Call TI | Call TI |

⁽¹⁾ The marketing status values are defined as follows:

ACTIVE: Product device recommended for new designs.

LIFEBUY: TI has announced that the device will be discontinued, and a lifetime-buy period is in effect.

NRND: Not recommended for new designs. Device is in production to support existing customers, but TI does not recommend using this part in a new design.

PREVIEW: Device has been announced but is not in production. Samples may or may not be available.

OBSOLETE: TI has discontinued the production of the device.

⁽²⁾ Eco Plan - The planned eco-friendly classification: Pb-Free (RoHS), Pb-Free (RoHS Exempt), or Green (RoHS & no Sb/Br) - please check <http://www.ti.com/productcontent> for the latest availability information and additional product content details.

TBD: The Pb-Free/Green conversion plan has not been defined.

Pb-Free (RoHS): TI's terms "Lead-Free" or "Pb-Free" mean semiconductor products that are compatible with the current RoHS requirements for all 6 substances, including the requirement that lead not exceed 0.1% by weight in homogeneous materials. Where designed to be soldered at high temperatures, TI Pb-Free products are suitable for use in specified lead-free processes.

Pb-Free (RoHS Exempt): This component has a RoHS exemption for either 1) lead-based flip-chip solder bumps used between the die and package, or 2) lead-based die adhesive used between the die and leadframe. The component is otherwise considered Pb-Free (RoHS compatible) as defined above.

Green (RoHS & no Sb/Br): TI defines "Green" to mean Pb-Free (RoHS compatible), and free of Bromine (Br) and Antimony (Sb) based flame retardants (Br or Sb do not exceed 0.1% by weight in homogeneous material)

⁽³⁾ MSL, Peak Temp. -- The Moisture Sensitivity Level rating according to the JEDEC industry standard classifications, and peak solder temperature.

Important Information and Disclaimer:The information provided on this page represents TI's knowledge and belief as of the date that it is provided. TI bases its knowledge and belief on information provided by third parties, and makes no representation or warranty as to the accuracy of such information. Efforts are underway to better integrate information from third parties. TI has taken and continues to take reasonable steps to provide representative and accurate information but may not have conducted destructive testing or chemical analysis on incoming materials and chemicals. TI and TI suppliers consider certain information to be proprietary, and thus CAS numbers and other limited information may not be available for release.

In no event shall TI's liability arising out of such information exceed the total purchase price of the TI part(s) at issue in this document sold by TI to Customer on an annual basis.

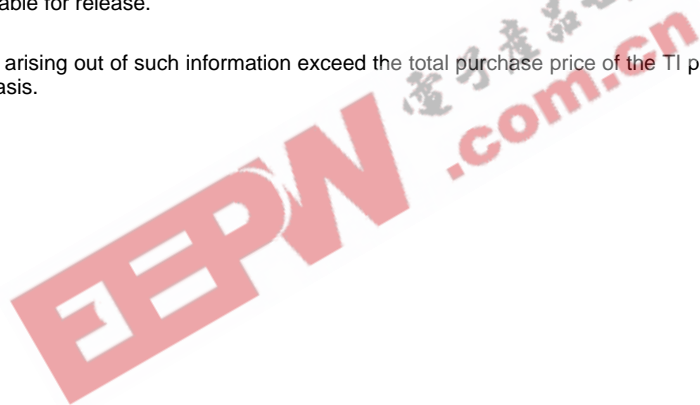

MECHANICAL DATA

D (R-PDSO-G8)

PLASTIC SMALL-OUTLINE PACKAGE

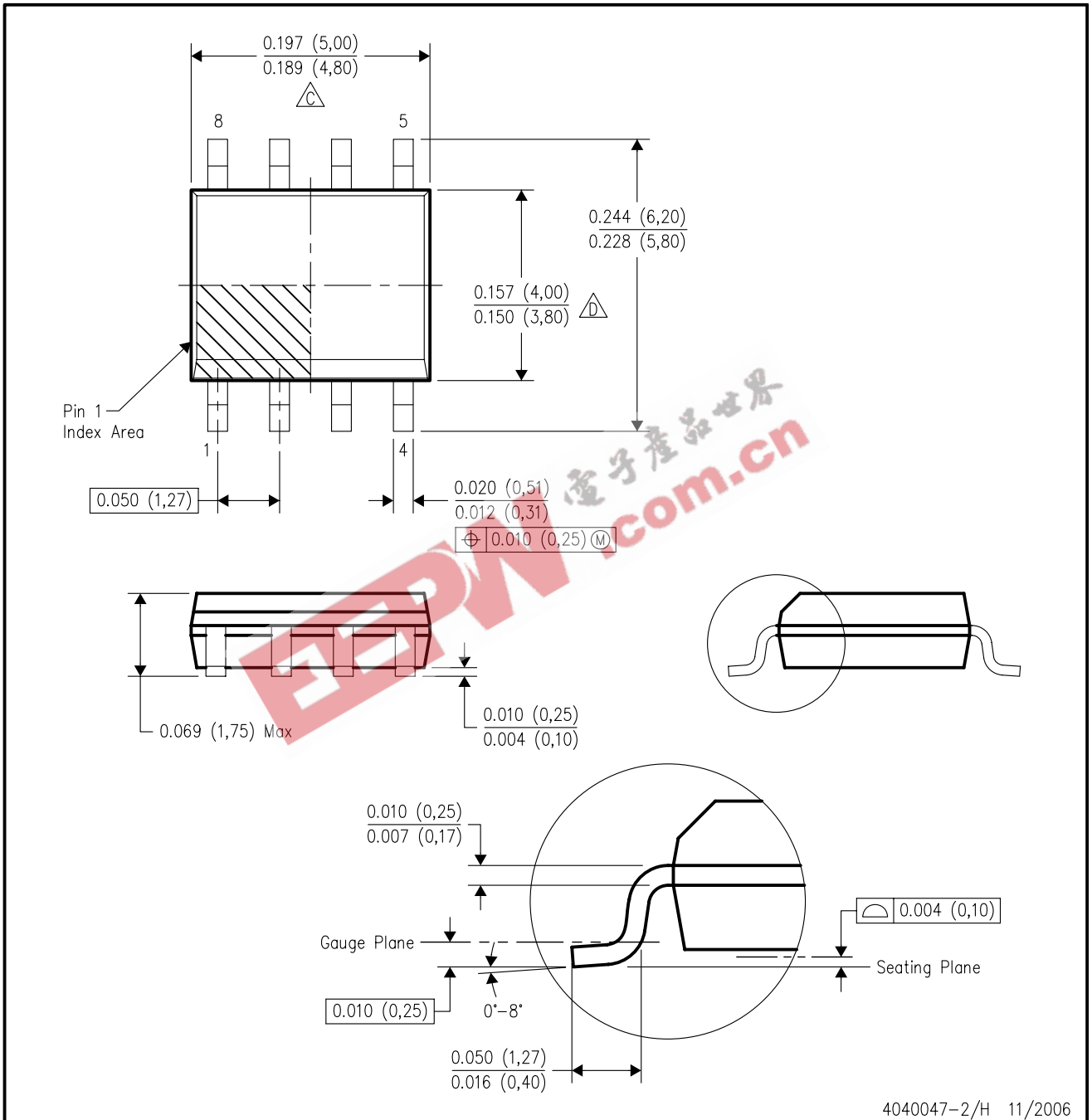

- NOTES:
- A. All linear dimensions are in inches (millimeters).
 - B. This drawing is subject to change without notice.
 - C. Body length does not include mold flash, protrusions, or gate burrs. Mold flash, protrusions, or gate burrs shall not exceed .006 (0,15) per end.
 - D. Body width does not include interlead flash. Interlead flash shall not exceed .017 (0,43) per side.
 - E. Reference JEDEC MS-012 variation AA.



MECHANICAL DATA

MSOT002A – OCTOBER 1994 – REVISED NOVEMBER 2001

LP (O-PBCY-W3)

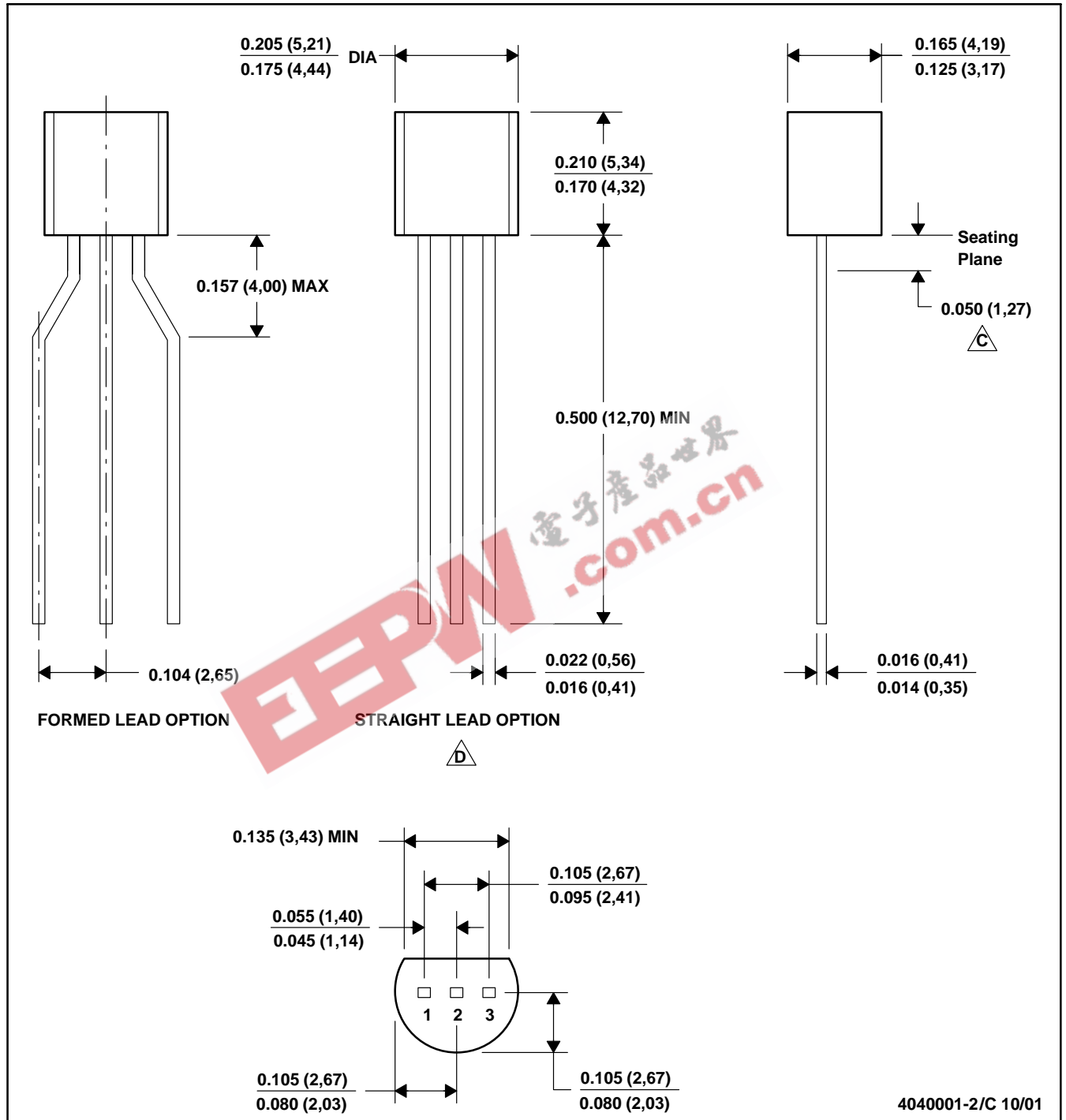
PLASTIC CYLINDRICAL PACKAGE



- NOTES:
- A. All linear dimensions are in inches (millimeters).
 - B. This drawing is subject to change without notice.
 -  C. Lead dimensions are not controlled within this area
 -  D. Falls within JEDEC TO -226 Variation AA (TO-226 replaces TO-92)
 - E. Shipping Method:
 - Straight lead option available in bulk pack only.
 - Formed lead option available in tape & reel or ammo pack.

MECHANICAL DATA

MSOT002A – OCTOBER 1994 – REVISED NOVEMBER 2001

LP (O-PBCY-W3)

PLASTIC CYLINDRICAL PACKAGE

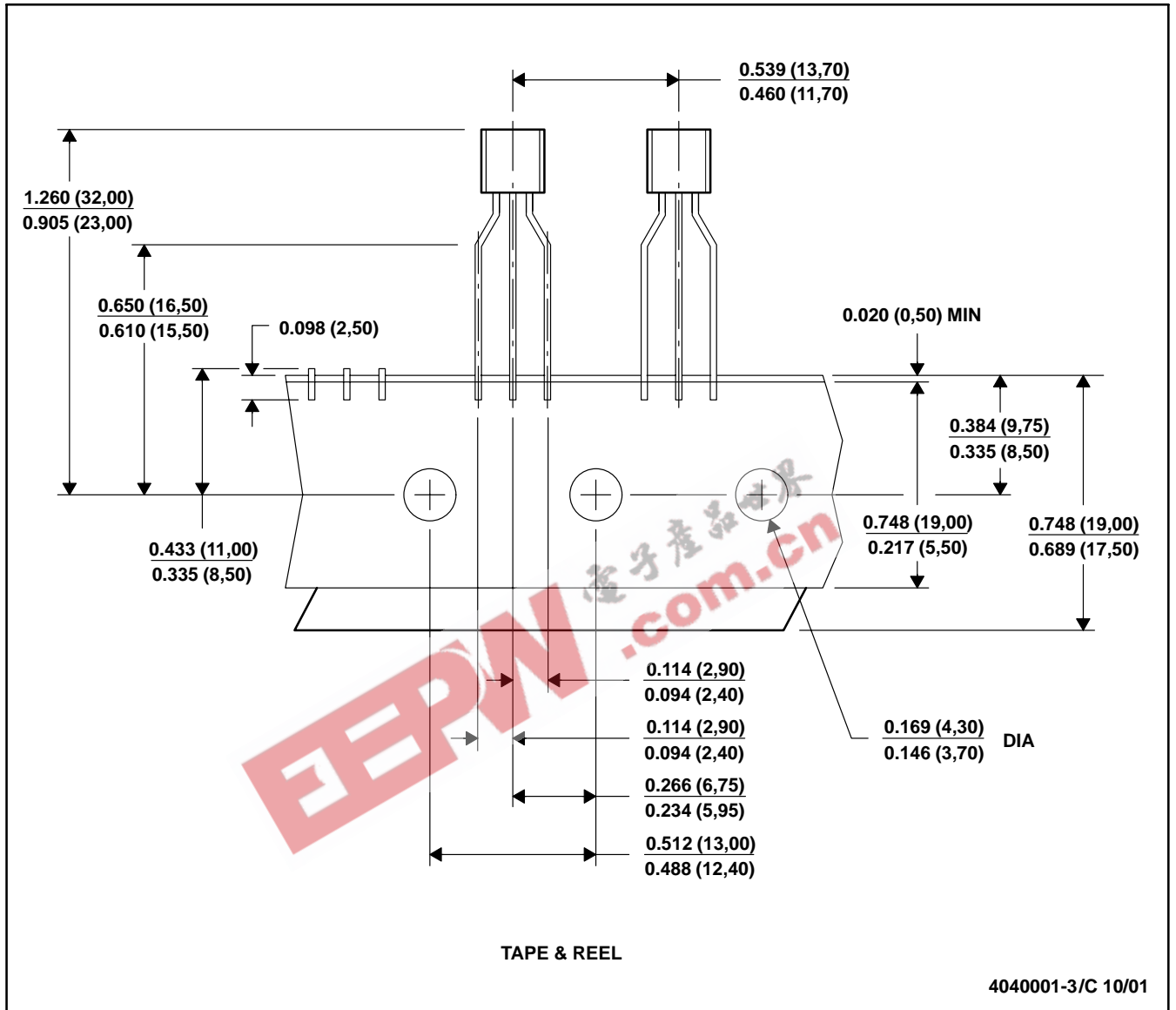

- NOTES:
- All linear dimensions are in inches (millimeters).
 - This drawing is subject to change without notice.
 - Tape and Reel information for the Format Lead Option package.

PACKAGING INFORMATION

| Orderable Device | Status ⁽¹⁾ | Package Type | Package Drawing | Pins | Package Qty | Eco Plan ⁽²⁾ | Lead/Ball Finish | MSL Peak Temp ⁽³⁾ |
|------------------|-----------------------|--------------|-----------------|------|-------------|-------------------------|------------------|------------------------------|
| TL7757CD | ACTIVE | SOIC | D | 8 | 75 | Green (RoHS & no Sb/Br) | CU NIPDAU | Level-1-260C-UNLIM |
| TL7757CDE4 | ACTIVE | SOIC | D | 8 | 75 | Green (RoHS & no Sb/Br) | CU NIPDAU | Level-1-260C-UNLIM |
| TL7757CDR | ACTIVE | SOIC | D | 8 | 2500 | Green (RoHS & no Sb/Br) | CU NIPDAU | Level-1-260C-UNLIM |
| TL7757CDRE4 | ACTIVE | SOIC | D | 8 | 2500 | Green (RoHS & no Sb/Br) | CU NIPDAU | Level-1-260C-UNLIM |
| TL7757CLP | ACTIVE | TO-92 | LP | 3 | 1000 | Pb-Free (RoHS) | CU SN | N / A for Pkg Type |
| TL7757CLPE3 | ACTIVE | TO-92 | LP | 3 | 1000 | Pb-Free (RoHS) | CU SN | N / A for Pkg Type |
| TL7757CLPR | ACTIVE | TO-92 | LP | 3 | 2000 | Pb-Free (RoHS) | CU SN | N / A for Pkg Type |
| TL7757CLPRE3 | ACTIVE | TO-92 | LP | 3 | 2000 | Pb-Free (RoHS) | CU SN | N / A for Pkg Type |
| TL7757CPK | ACTIVE | SOT-89 | PK | 3 | 1000 | Green (RoHS & no Sb/Br) | CU SN | Level-2-260C-1YEAR |
| TL7757CPKG3 | ACTIVE | SOT-89 | PK | 3 | 1000 | Green (RoHS & no Sb/Br) | CU SN | Level-2-260C-1YEAR |
| TL7757ID | ACTIVE | SOIC | D | 8 | 75 | Green (RoHS & no Sb/Br) | CU NIPDAU | Level-1-260C-UNLIM |
| TL7757IDE4 | ACTIVE | SOIC | D | 8 | 75 | Green (RoHS & no Sb/Br) | CU NIPDAU | Level-1-260C-UNLIM |
| TL7757IDR | ACTIVE | SOIC | D | 8 | 2500 | Green (RoHS & no Sb/Br) | CU NIPDAU | Level-1-260C-UNLIM |
| TL7757IDRE4 | ACTIVE | SOIC | D | 8 | 2500 | Green (RoHS & no Sb/Br) | CU NIPDAU | Level-1-260C-UNLIM |
| TL7757ILP | ACTIVE | TO-92 | LP | 3 | 1000 | Pb-Free (RoHS) | CU SN | N / A for Pkg Type |
| TL7757ILPE3 | ACTIVE | TO-92 | LP | 3 | 1000 | Pb-Free (RoHS) | CU SN | N / A for Pkg Type |
| TL7757ILPR | ACTIVE | TO-92 | LP | 3 | 2000 | Pb-Free (RoHS) | CU SN | N / A for Pkg Type |
| TL7757ILPRE3 | ACTIVE | TO-92 | LP | 3 | 2000 | Pb-Free (RoHS) | CU SN | N / A for Pkg Type |
| TL7757IPK | ACTIVE | SOT-89 | PK | 3 | 1000 | Green (RoHS & no Sb/Br) | CU SN | Level-2-260C-1YEAR |
| TL7757IPKG3 | ACTIVE | SOT-89 | PK | 3 | 1000 | Green (RoHS & no Sb/Br) | CU SN | Level-2-260C-1YEAR |
| TL7757MD | OBSOLETE | SOIC | D | 8 | | TBD | Call TI | Call TI |
| TL7757MDR | OBSOLETE | SOIC | D | 8 | | TBD | Call TI | Call TI |
| TL7757MLP | OBSOLETE | TO-92 | LP | 3 | | TBD | Call TI | Call TI |

⁽¹⁾ The marketing status values are defined as follows:

ACTIVE: Product device recommended for new designs.

LIFEBUY: TI has announced that the device will be discontinued, and a lifetime-buy period is in effect.

NRND: Not recommended for new designs. Device is in production to support existing customers, but TI does not recommend using this part in a new design.

PREVIEW: Device has been announced but is not in production. Samples may or may not be available.

OBSOLETE: TI has discontinued the production of the device.

⁽²⁾ Eco Plan - The planned eco-friendly classification: Pb-Free (RoHS), Pb-Free (RoHS Exempt), or Green (RoHS & no Sb/Br) - please check <http://www.ti.com/productcontent> for the latest availability information and additional product content details.

TBD: The Pb-Free/Green conversion plan has not been defined.

Pb-Free (RoHS): TI's terms "Lead-Free" or "Pb-Free" mean semiconductor products that are compatible with the current RoHS requirements for all 6 substances, including the requirement that lead not exceed 0.1% by weight in homogeneous materials. Where designed to be soldered at high temperatures, TI Pb-Free products are suitable for use in specified lead-free processes.

Pb-Free (RoHS Exempt): This component has a RoHS exemption for either 1) lead-based flip-chip solder bumps used between the die and package, or 2) lead-based die adhesive used between the die and leadframe. The component is otherwise considered Pb-Free (RoHS compatible) as defined above.

Green (RoHS & no Sb/Br): TI defines "Green" to mean Pb-Free (RoHS compatible), and free of Bromine (Br) and Antimony (Sb) based flame retardants (Br or Sb do not exceed 0.1% by weight in homogeneous material)

⁽³⁾ MSL, Peak Temp. -- The Moisture Sensitivity Level rating according to the JEDEC industry standard classifications, and peak solder temperature.

Important Information and Disclaimer:The information provided on this page represents TI's knowledge and belief as of the date that it is provided. TI bases its knowledge and belief on information provided by third parties, and makes no representation or warranty as to the accuracy of such information. Efforts are underway to better integrate information from third parties. TI has taken and continues to take reasonable steps to provide representative and accurate information but may not have conducted destructive testing or chemical analysis on incoming materials and chemicals. TI and TI suppliers consider certain information to be proprietary, and thus CAS numbers and other limited information may not be available for release.

In no event shall TI's liability arising out of such information exceed the total purchase price of the TI part(s) at issue in this document sold by TI to Customer on an annual basis.

EEPW.com.cn

MECHANICAL DATA

PK (R-PSS0-F3)

PLASTIC SINGLE-IN-LINE PACKAGE

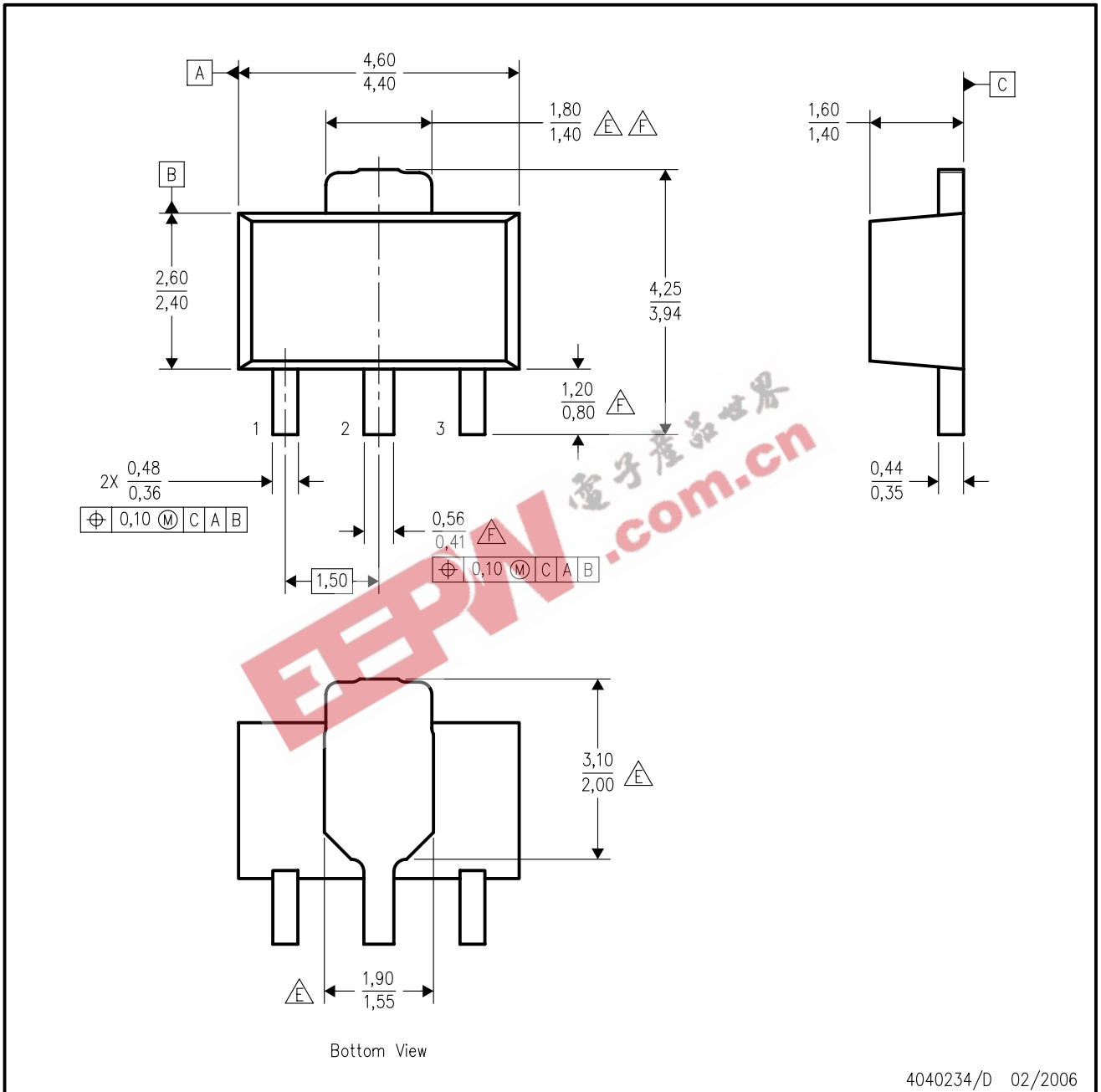

- NOTES:
- All linear dimensions are in millimeters. Dimensioning and tolerancing per ASME Y14.5M-1994.
 - This drawing is subject to change without notice.
 - The center lead is in electrical contact with the tab.
 - Body dimensions do not include mold flash or protrusion. Mold flash and protrusion not to exceed 0.15 per side.
- △E Thermal pad contour optional within these dimensions.
- △F Falls within JEDEC TO-243 variation AA, except minimum lead length, pin 2 minimum lead width, minimum tab width.

PK (R-PDSO-G3)

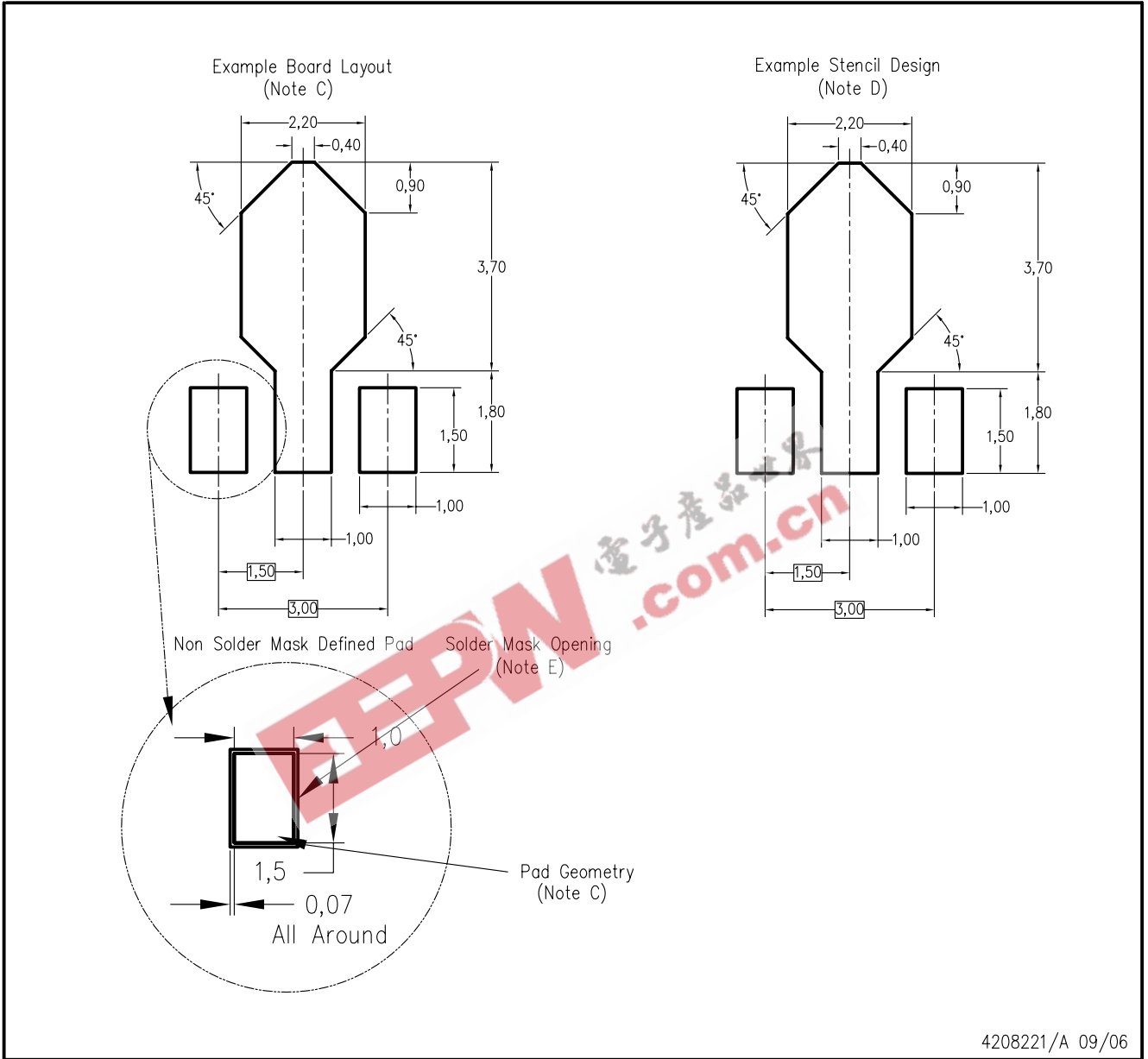

- NOTES:
- A. All linear dimensions are in millimeters.
 - B. This drawing is subject to change without notice.
 - C. Publication IPC-7351 is recommended for alternate designs.
 - D. Laser cutting apertures with trapezoidal walls and also rounding corners will offer better paste release. Customers should contact their board assembly site for stencil design recommendations. Refer to IPC-7525.
 - E. Customers should contact their board fabrication site for solder mask tolerances between and around signal pads.

MECHANICAL DATA

D (R-PDSO-G8)

PLASTIC SMALL-OUTLINE PACKAGE

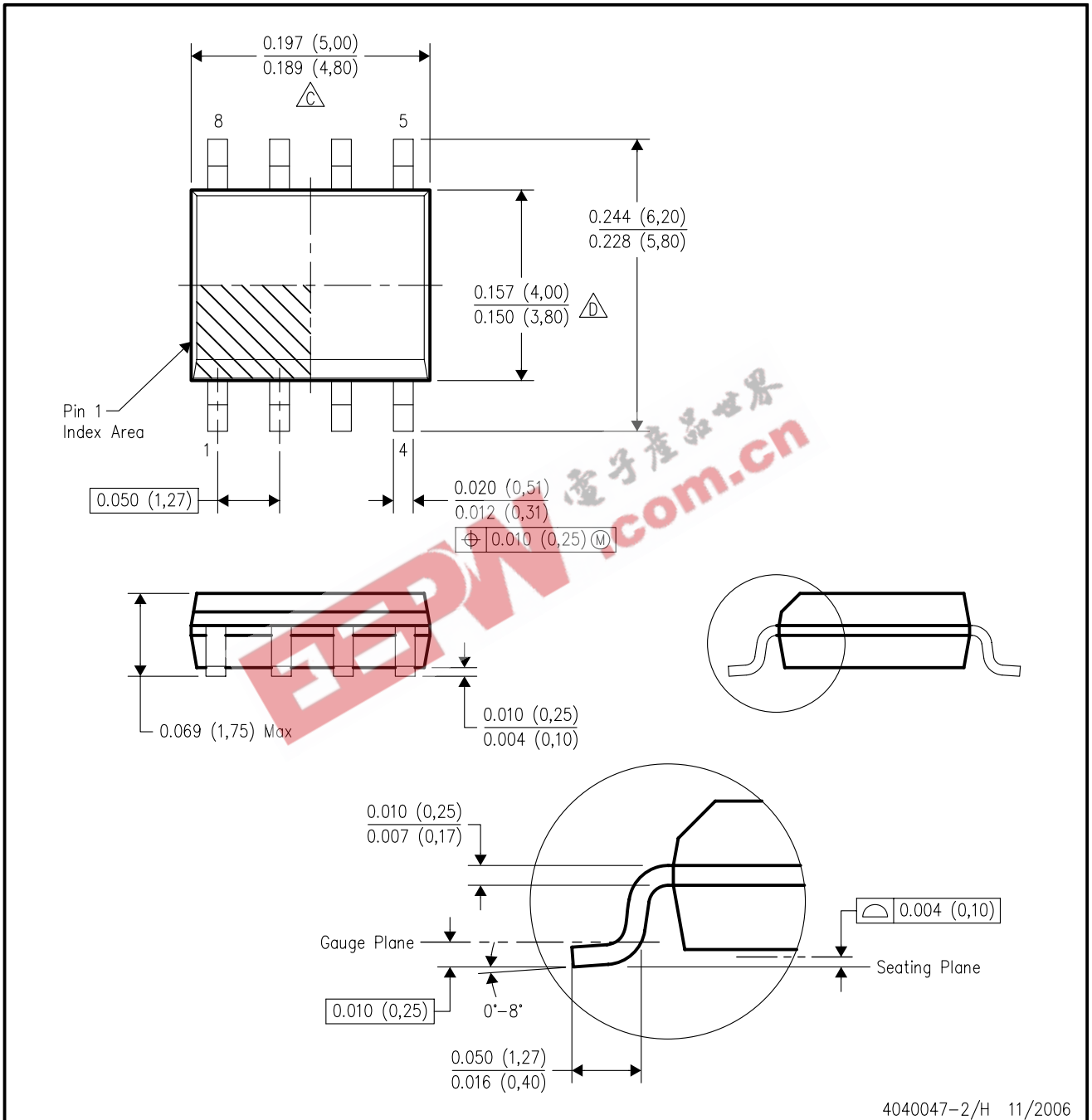

- NOTES:
- A. All linear dimensions are in inches (millimeters).
 - B. This drawing is subject to change without notice.
 - △C Body length does not include mold flash, protrusions, or gate burrs. Mold flash, protrusions, or gate burrs shall not exceed .006 (0,15) per end.
 - △D Body width does not include interlead flash. Interlead flash shall not exceed .017 (0,43) per side.
 - E. Reference JEDEC MS-012 variation AA.

MECHANICAL DATA

MSOT002A – OCTOBER 1994 – REVISED NOVEMBER 2001

LP (O-PBCY-W3)

PLASTIC CYLINDRICAL PACKAGE

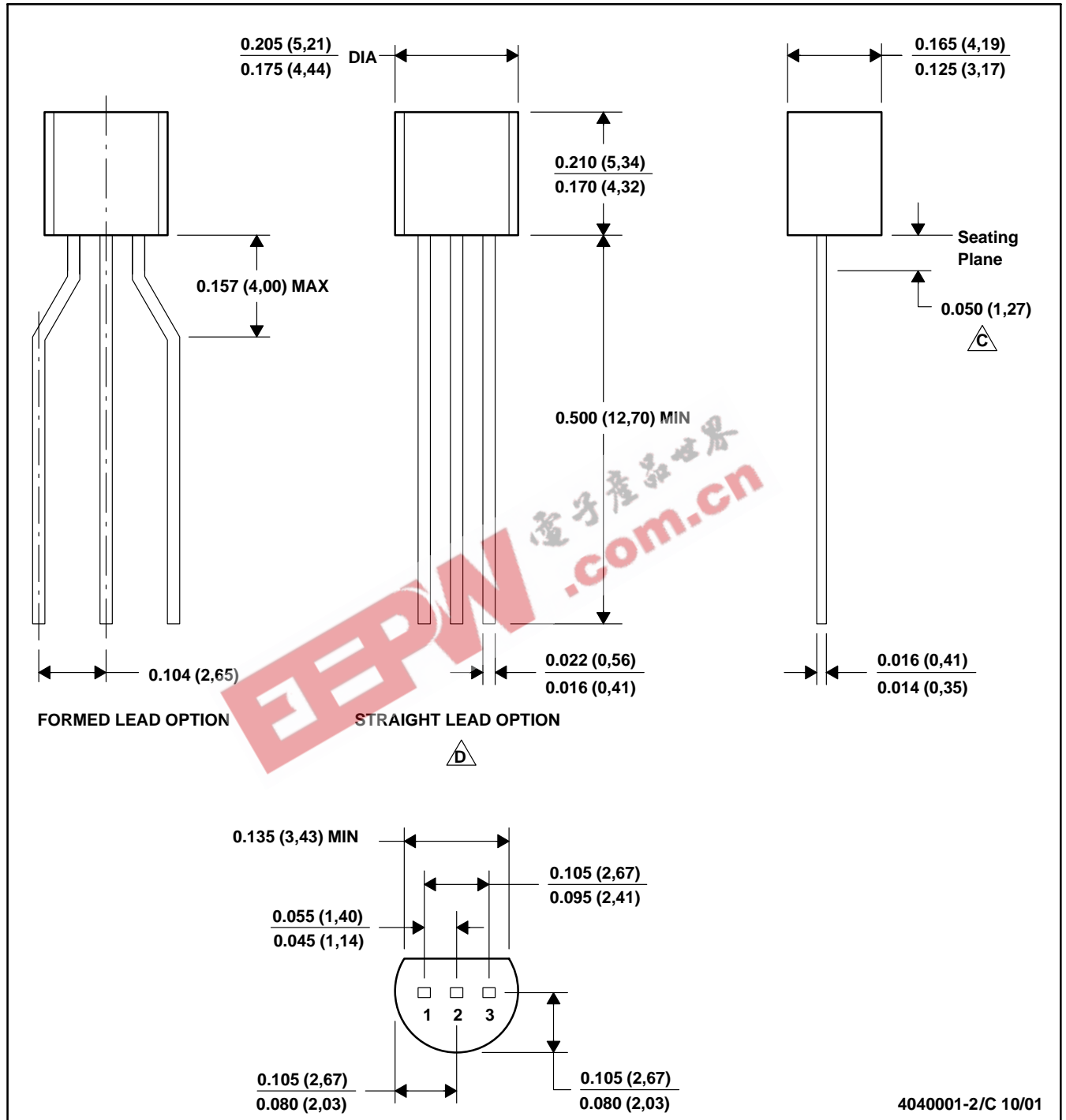

- NOTES:
- All linear dimensions are in inches (millimeters).
 - This drawing is subject to change without notice.
 - $\triangle C$ Lead dimensions are not controlled within this area
 - $\triangle D$ Falls within JEDEC TO -226 Variation AA (TO-226 replaces TO-92)
 - $\triangle E$ Shipping Method:
 - Straight lead option available in bulk pack only.
 - Formed lead option available in tape & reel or ammo pack.

MECHANICAL DATA

MSOT002A – OCTOBER 1994 – REVISED NOVEMBER 2001

LP (O-PBCY-W3)

PLASTIC CYLINDRICAL PACKAGE

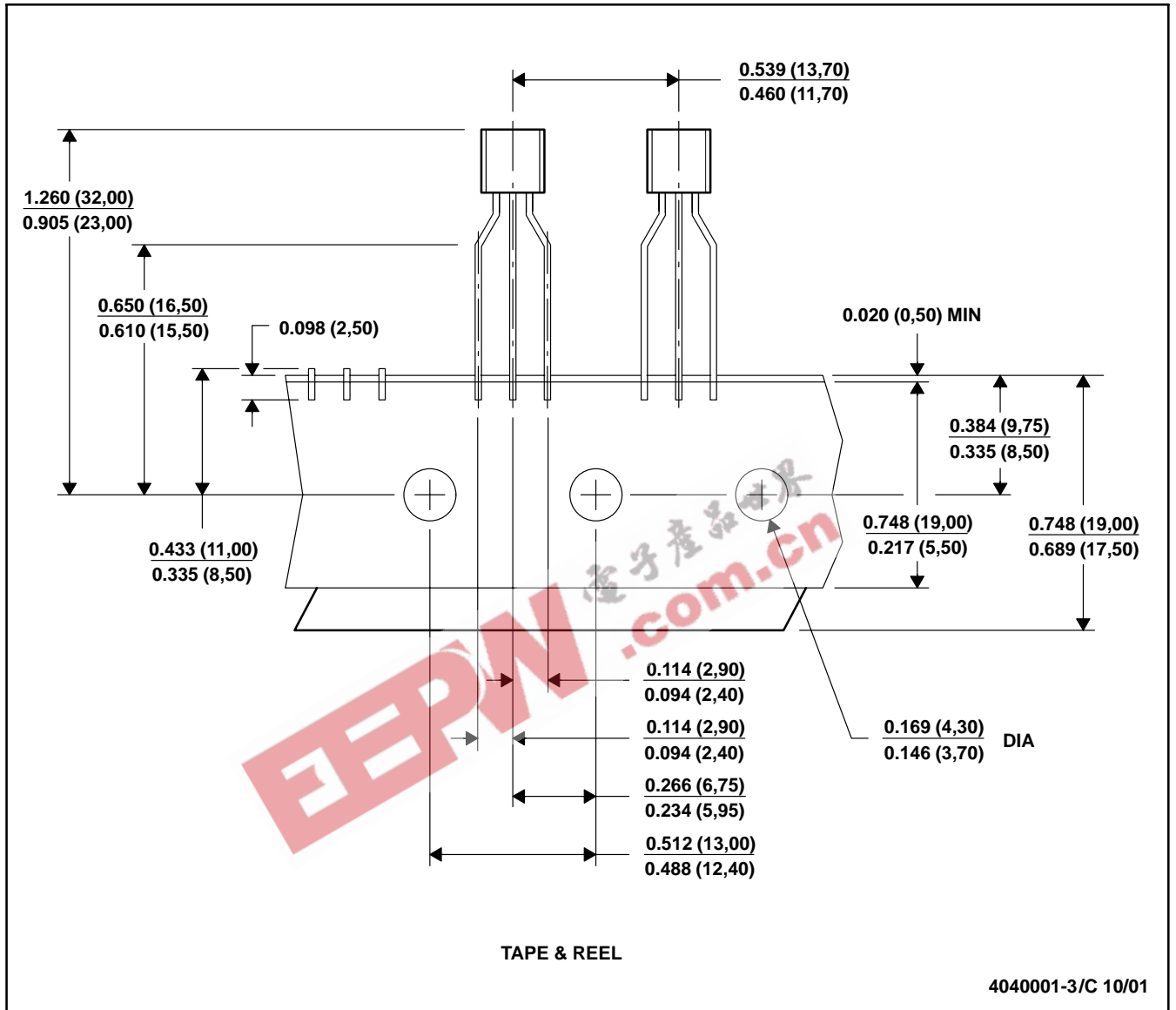

- NOTES:
- All linear dimensions are in inches (millimeters).
 - This drawing is subject to change without notice.
 - Tape and Reel information for the Format Lead Option package.