

TACT SWITCHES

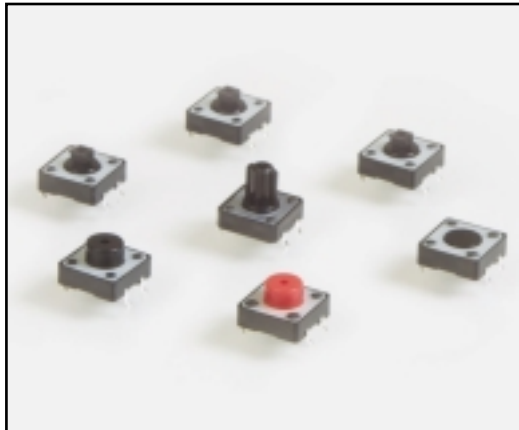

SPECIFICATIONS

Rating:	50mA@50 VDC
Electrical Life:	100,000 cycles
Contact Resistance:	100mΩ max., typical @ 2-4 VDC 100mA for both silver and gold plated contacts
Insulation Resistance:	1,000MΩ min.
Dielectric Strength:	>1,000 V rms at sea level
Operating Force:	160 ± 50 gf, 260 ± 50 gf

MATERIALS

Housing:	Polybutylene Terephthalate (PBT)
Actuator:	Polybutylene Terephthalate (PBT)
Cover:	Polyester
Contacts:	Silver plated phosphor bronze
Terminals:	Silver plated copper alloy

HOW TO ORDER

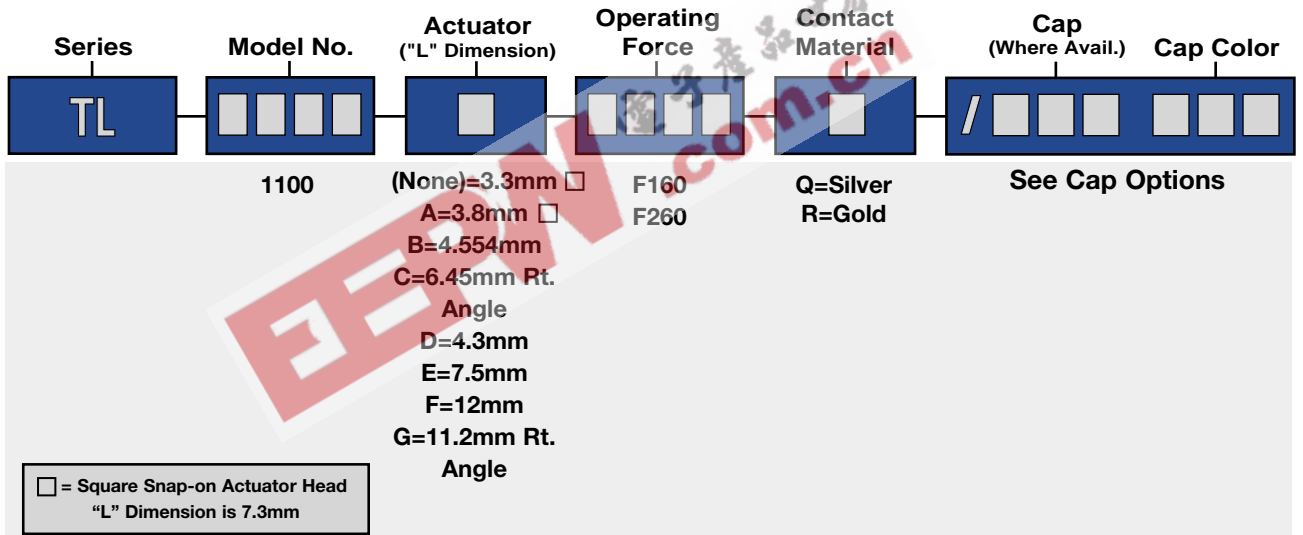

EXAMPLE

TL → 1100 → C → F260 → Q → TAK → GRY

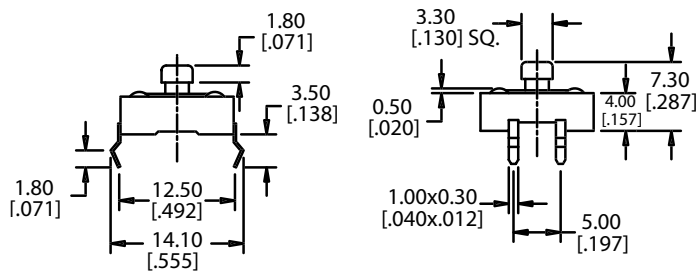

P.C. MOUNTING

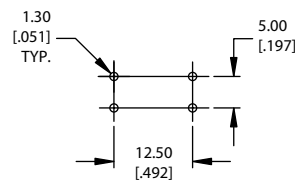

SERIES TL SWITCHES

TACT SWITCH

P.C. MOUNTING



TL 1100 A

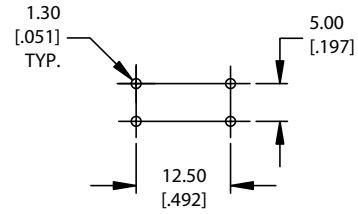
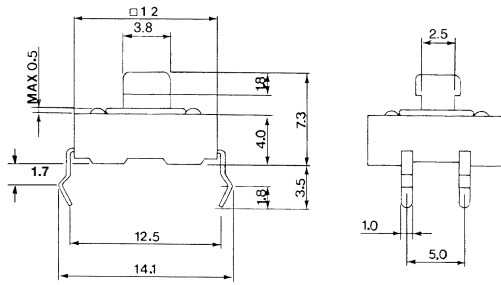

TL 1100 C

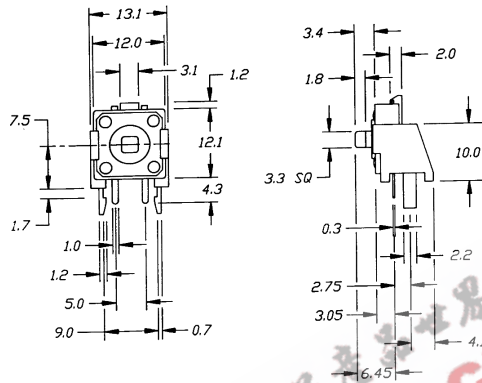

P.C. MOUNTING

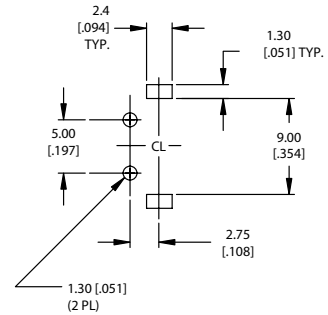

TL 1100 B

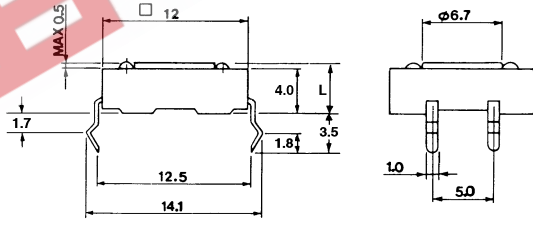

P.C. MOUNTING

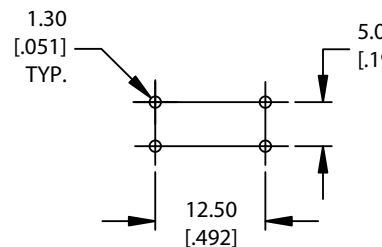

TL 1100 D

SPECIFICATIONS SUBJECT TO CHANGE WITHOUT NOTICE.

Actuator Length (L) in mm
B = 4.55 mm
D = 4.3 mm



TL 1100 E

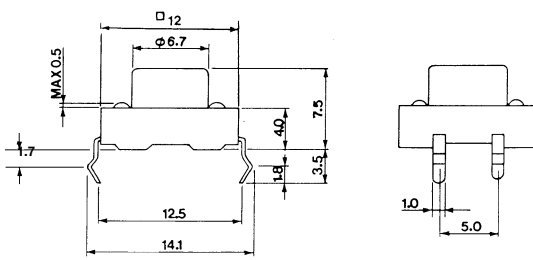

P.C. MOUNTING

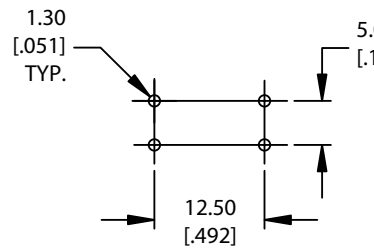

SERIES TL SWITCHES

TACT SWITCHES

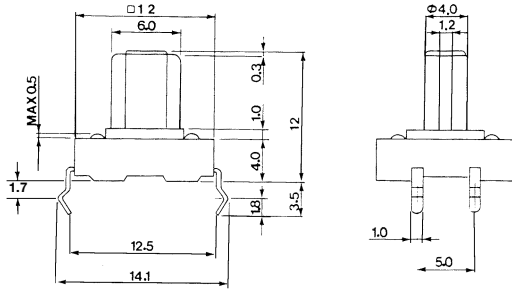

P.C. MOUNTING

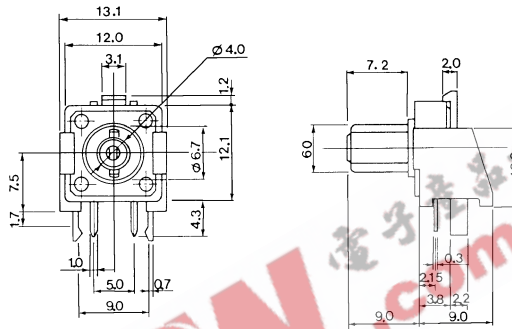
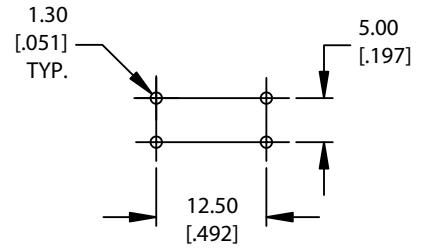

P.C. MOUNTING

