

# TL592B DIFFERENTIAL VIDEO AMPLIFIER

SLFS001A – JUNE 1985 – REVISED APRIL 1988

- Adjustable Gain to 400 Typ
- No Frequency Compensation Required
- Low Noise . . .  $3 \mu\text{V Typ } V_n$

## description

This device is a monolithic two-stage video amplifier with differential inputs and differential outputs. It features internal series-shunt feedback that provides wide bandwidth, low phase distortion, and excellent gain stability. Emitter-follower outputs enable the device to drive capacitive loads. All stages are current-source biased to obtain high common-mode and supply-voltage rejection ratios.

The differential gain is typically 400 when the gain adjust pins are connected together, or amplification may be adjusted for near 0 to 400 by the use of a single external resistor connected between the gain adjustment pins A and B. No external frequency-compensating components are required for any gain option.

The device is particularly useful in magnetic-tape or disk-file systems using phase or NRZ encoding and in high-speed thin-film or plated-wire memories. Other applications include general-purpose video and pulse amplifiers.

The device achieves low equivalent noise voltage through special processing and a new circuit layout incorporating input transistors with low base resistance.

The TL592B is characterized for operation from  $0^\circ\text{C}$  to  $70^\circ\text{C}$ .

D8T OR P PACKAGE  
(TOP VIEW)

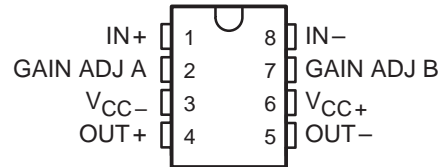

D14† OR N PACKAGE  
(TOP VIEW)

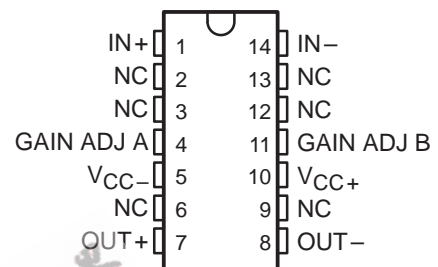

† D8 and D14 are the codes to differentiate the 8-pin and 14-pin versions, respectively.

## symbol

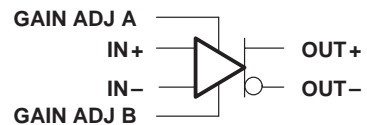

# TL592B DIFFERENTIAL VIDEO AMPLIFIER

SLFS001A – JUNE 1985 – REVISED APRIL 1988

## schematic

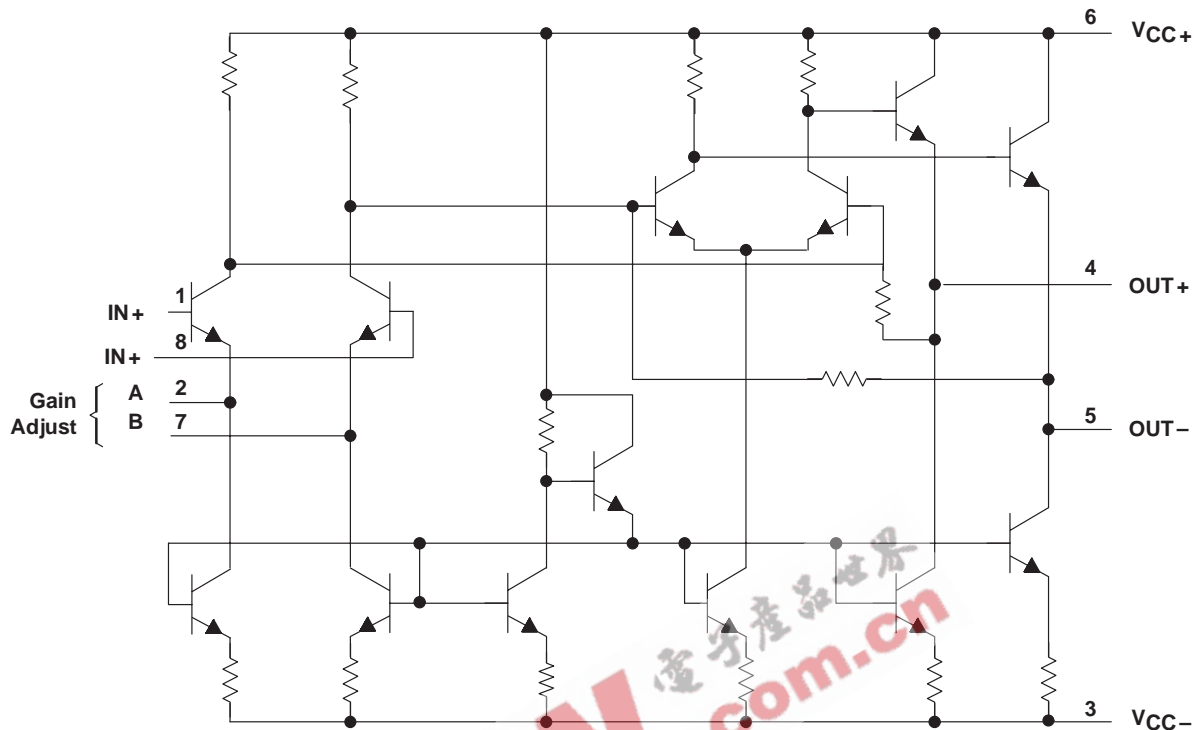

Pin numbers are for D8 and P packages.

## absolute maximum ratings over operating free-air temperature (unless otherwise noted)

Supply voltage, $V_{CC+}$ (see Note 1)	8 V
Supply voltage, $V_{CC-}$	-8 V
Differential input voltage	$\pm 5$ V
Voltage range, any input	$V_{CC+}$ to $V_{CC-}$
Output current	10 mA
Continuous total power dissipation	See Dissipation Rating Table
Operating free-air temperature range	0°C to 70°C
Storage temperature range	-65°C to 150°C
Lead temperature 1,6 mm (1/16 inch) from case for 10 seconds	260°C

NOTES: 1. All voltage values except differential input voltages are with respect to the midpoint between  $V_{CC+}$  and  $V_{CC-}$ .

DISSIPATION RATING TABLE

PACKAGE	$T_A \leq 25^\circ\text{C}$ POWER RATING	DERATING FACTOR	DERATE ABOVE $T_A$	$T_A = 70^\circ\text{C}$ POWER RATING
D8	530 mW	5.8 mW/°C	59°C	464 mW
D14	530 mW	N/A	N/A	530 mW
N	530 mW	N/A	N/A	530 mW
P	530 mW	N/A	N/A	530 mW

# TL592B DIFFERENTIAL VIDEO AMPLIFIER

SLFS001A – JUNE 1985 – REVISED APRIL 1988

## recommended operating conditions

	MIN	NOM	MAX	UNIT
Supply voltage, $V_{CC+}$	3	6	8	V
Supply voltage, $V_{CC-}$	-3	-6	-8	V
Operating free-air temperature, $T_A$	0		70	°C

## electrical characteristics at specified free-air temperature, $V_{CC\pm} = \pm 6$ V, $R_L = 2$ k $\Omega$ (unless otherwise noted)

PARAMETER	TEST FIGURE	TEST CONDITION <sup>†</sup>	$T_A$	MIN	TYP	MAX	UNIT
$A_{VD}$	1	$V_{OPP} = 3$ V, $R_L = 2$ k $\Omega$ , $R_{AB} = 0$	25°C	300	400	500	V/V
			0°C to 70°C	250		600	
$A_{VD2}$	1	$V_{OPP} = 3$ V, $R_L = 2$ k $\Omega$ , $R_{AB} = 1$ k $\Omega$	25°C		13		V/V
BW	2	$V_{OPP} = 1$ V, $R_{AB} = 0$	25°C		50		MHz
$I_{IO}$			25°C		0.4	5	$\mu$ A
			0°C to 70°C			6	
$I_{IB}$			25°C		9	30	$\mu$ A
			0°C to 70°C			40	
$V_{ICR}$	3		25°C	$\pm 1$			V
			0°C to 70°C	$\pm 1$			
$V_{OC}$	1	$R_L = \infty$	25°C	2.4	2.9	3.4	V
$V_{OO}$	1	$V_{ID} = 0$ , $R_L = \infty$ , $R_{AB} = \infty$	25°C		0.35	0.75	V
			0°C to 70°C			1.5	
$V_{OPP}$	1	$R_L = 2$ k $\Omega$ , $R_{AB} = 0$	25°C	3	4		V
			0°C to 70°C	2.8			
$r_i$		$V_{OD} = 1$ V, $R_{AB} = 0$	25°C		4		k $\Omega$
			0°C to 70°C		3.6		
$r_o$			0°C to 70°C			30	$\Omega$
$C_i$			25°C		5		pF
$CMRR$	3	$V_{IC} = \pm 1$ V, $R_{AB} = 0$	25°C	f = 100 kHz	60	86	dB
				f = 5 MHz		60	
			0°C to 70°C	f = 100 kHz	50		
				f = 5 MHz		60	
$k_{SVR}$	4	$\Delta V_{CC+} = \pm 0.5$ V, $\Delta V_{CC-} = \pm 0.5$ V, $R_{AB} = 0$	25°C	50	70		dB
			0°C to 70°C	50			
$V_n$	4	BW = 1 kHz to 10 MHz	25°C		3		$\mu$ V
$t_{pd}$	2	$\Delta V_O = 1$ V	25°C		7.5		ns
$t_r$	2	$\Delta V_O = 1$ V	25°C		10.5		ns
$I_{sink(max)}$		$V_{ID} = 1$ V, $V_O = 3$ V		3	4		mA
$I_{CC}$		No load, No signal	25°C		18	24	mA
			0°C to 70°C			27	

<sup>†</sup>  $R_{AB}$  is the gain-adjustment resistor connected between gain-adjust pins A and B. If not specified for a particular parameter, its value is irrelevant to that parameter.

# TL592B DIFFERENTIAL VIDEO AMPLIFIER

SLFS001A – JUNE 1985 – REVISED APRIL 1988

## PARAMETER MEASUREMENT INFORMATION

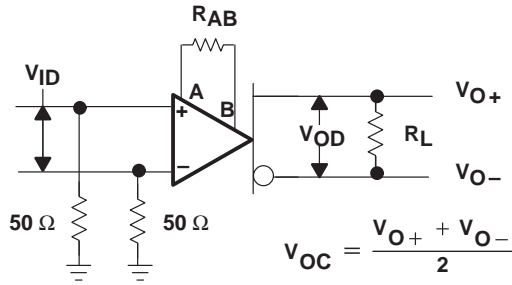

Figure 1

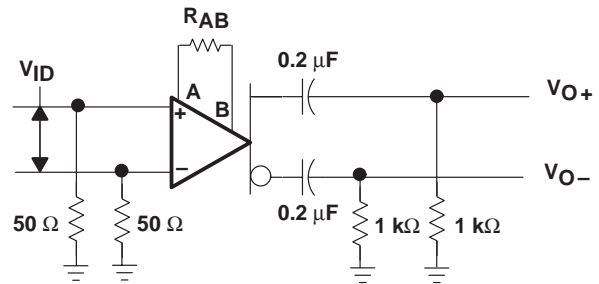

Figure 2

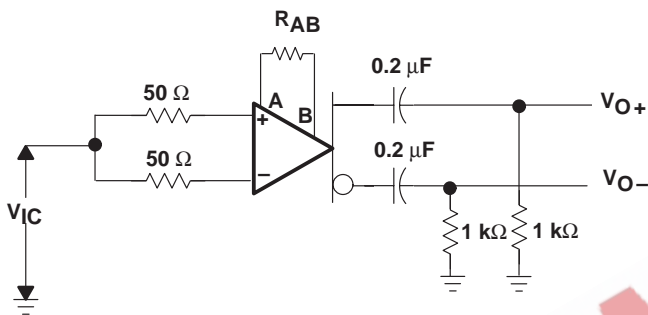

Figure 3

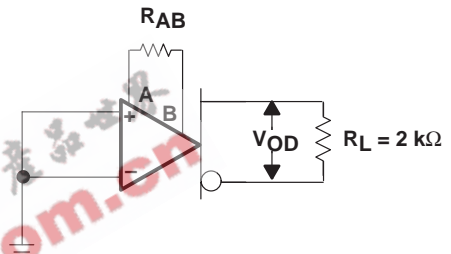

Figure 4

EEPW.com.cn

TYPICAL CHARACTERISTICS

LARGE-SIGNAL DIFFERENTIAL  
VOLTAGE AMPLIFICATION  
VS  
SUPPLY VOLTAGE

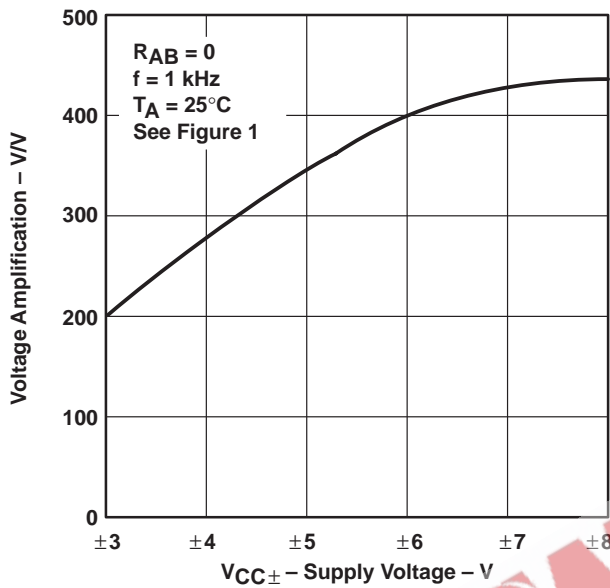

Figure 5

LARGE-SIGNAL DIFFERENTIAL  
VOLTAGE AMPLIFICATION  
VS  
GAIN-ADJUSTMENT RESISTANCE

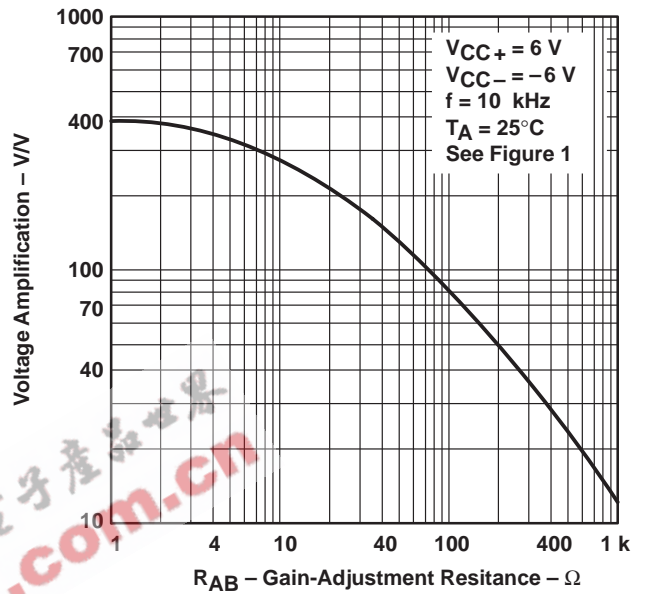

Figure 6

SUPPLY CURRENT  
VS  
SUPPLY VOLTAGE

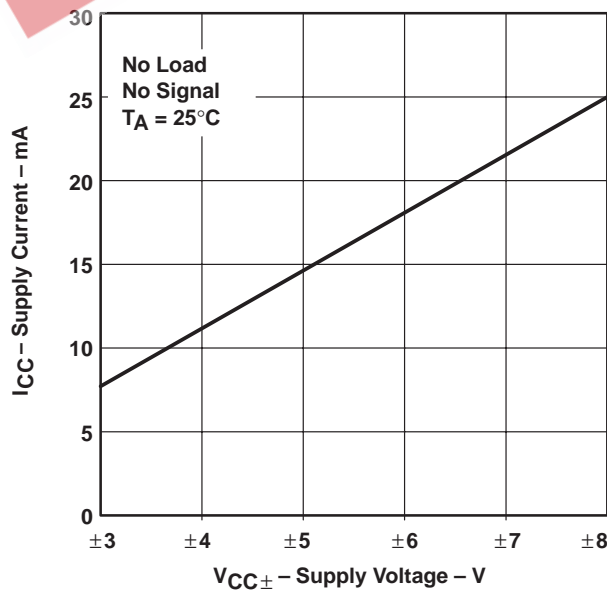

Figure 7

## IMPORTANT NOTICE

Texas Instruments and its subsidiaries (TI) reserve the right to make changes to their products or to discontinue any product or service without notice, and advise customers to obtain the latest version of relevant information to verify, before placing orders, that information being relied on is current and complete. All products are sold subject to the terms and conditions of sale supplied at the time of order acknowledgement, including those pertaining to warranty, patent infringement, and limitation of liability.

TI warrants performance of its semiconductor products to the specifications applicable at the time of sale in accordance with TI's standard warranty. Testing and other quality control techniques are utilized to the extent TI deems necessary to support this warranty. Specific testing of all parameters of each device is not necessarily performed, except those mandated by government requirements.

CERTAIN APPLICATIONS USING SEMICONDUCTOR PRODUCTS MAY INVOLVE POTENTIAL RISKS OF DEATH, PERSONAL INJURY, OR SEVERE PROPERTY OR ENVIRONMENTAL DAMAGE ("CRITICAL APPLICATIONS"). TI SEMICONDUCTOR PRODUCTS ARE NOT DESIGNED, AUTHORIZED, OR WARRANTED TO BE SUITABLE FOR USE IN LIFE-SUPPORT DEVICES OR SYSTEMS OR OTHER CRITICAL APPLICATIONS. INCLUSION OF TI PRODUCTS IN SUCH APPLICATIONS IS UNDERSTOOD TO BE FULLY AT THE CUSTOMER'S RISK.

In order to minimize risks associated with the customer's applications, adequate design and operating safeguards must be provided by the customer to minimize inherent or procedural hazards.

TI assumes no liability for applications assistance or customer product design. TI does not warrant or represent that any license, either express or implied, is granted under any patent right, copyright, mask work right, or other intellectual property right of TI covering or relating to any combination, machine, or process in which such semiconductor products or services might be or are used. TI's publication of information regarding any third party's products or services does not constitute TI's approval, warranty or endorsement thereof.