

TOSHIBA Photocoupler GaAs Ired & Photo-Triac

TLP665J(S)

Office Machine
Household Use Equipment
Triac Driver
Solid State Relay

TOSHIBA TLP665J(S) consists of a photo-triac optically coupled to a gallium arsenide infrared emitting diode in a six lead plastic DIP package.

- Peak off-State voltage: 600V (Min.)
- Trigger LED current: 10mA (Max.)
- On-state current: 100mA (Max.)
- Isolation voltage: 5000Vrms (Min.)
- UL recognized: UL1577, file No. E67349
- SEMCO approved: EN60065, EN60950-1, EN60335-1

Certificate no.708960

- BSI approved: BS EN60065:2002, file No.8385
BS EN60950-1:2002, file No.8386

- Option(D4) type

VDE approved: DIN EN 60747-5-2

Certificate No. 40009302

Maximum operating insulation voltage : 890V_{Pk}

Highest permissible over voltage : 8000 V_{Pk}

(Note) When an EN60747-5-2 approved type is needed, please designate the "Option(D4)".

•Construction mechanical rating

	7.62 mm pich standard type	10.16 mm pich TLPXXXXF type
Creepage distance	7.0 mm (Min.)	8.0 mm (Min.)
Clearance	7.0 mm (Min.)	8.0 mm (Min.)
Insulation thickness	0.5 mm (Min.)	0.5 mm (Min.)

Unit: mm

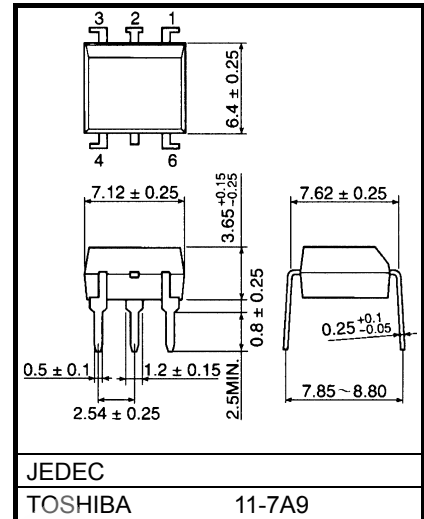

Weight: 0.39 g (Typ.)

Pin configuration (top view)

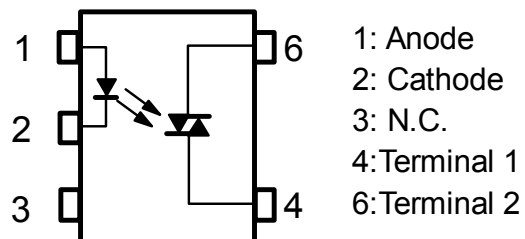

Absolute Maximum Ratings (Ta=25°C)

Characteristic		Symbol	Rating	Unit
LED	Forward current	I_F	50	mA
	Forward current derating (Ta≥53°C)	$\Delta I_F / ^\circ C$	-0.7	mA / °C
	Peak forward current (100µs pulse, 100pps)	I_{FP}	1	A
	Reverse voltage	V_R	5	V
Detector	Off-State output terminal voltage	V_{DRM}	600	V
	On-state RMS current	Ta=25°C	100	mA
		Ta=70°C	50	
	On-state current derating (Ta≥25°C)	$\Delta I_T / ^\circ C$	-1.1	mA / °C
	Peak on-state current (100µs pulse, 120pps)	I_{TP}	2	A
	Peak nonrepetitive surge current (Pw=10ms,DC=10%)	I_{TSM}	1.2	A
	Junction temperature	T_j	115	°C
Operating temperature range	T_{opr}	-40~100	°C	
Storage temperature range	T_{stg}	-55~125	°C	
Lead soldering temperature (10s)	T_{sol}	260	°C	
Isolation voltage (AC,1min. , R.H.≤60%)	(Note 2) BV_S	5000	Vrms	

Note: Using continuously under heavy loads (e.g. the application of high temperature/current/voltage and the significant change in temperature, etc.) may cause this product to decrease in the reliability significantly even if the operating conditions (i.e. operating temperature/current/voltage, etc.) are within the absolute maximum ratings.

Please design the appropriate reliability upon reviewing the Toshiba Semiconductor Reliability Handbook (“Handling Precautions”/“Derating Concept and Methods”) and individual reliability data (i.e. reliability test report and estimated failure rate, etc).

(Note 2) Pins1,2 and 3 shorted together and pin4 and pin6 shorted together.

Recommended Operating Conditions

Characteristic	Symbol	Min.	Typ.	Max.	Unit
Supply voltage	V_{AC}	—	—	240	Vac
Forward current	I_F	15	20	25	mA
Peak on-state current	I_{TP}	—	—	1	A
Operating temperature	T_{opr}	-25	—	85	°C

Note: Recommended operating conditions are given as a design guideline to obtain expected performance of the device. Additionally, each item is an independent guideline respectively. In developing designs using this product, please confirm specified characteristics shown in this document.

Electrical Characteristics (Ta=25°C)

Characteristic		Symbol	Test Condition	Min.	Typ.	Max.	Unit
LED	Forward voltage	V_F	$I_F = 10 \text{ mA}$	1.0	1.15	1.3	V
	Reverse current	I_R	$V_R = 5 \text{ V}$	—	—	10	μA
	Capacitance	C_T	$V = 0, f=1\text{MHz}$	—	30	—	pF
Detector	Peak off-state current	I_{DRM}	$V_{DRM} = 600\text{V}$	—	10	1000	nA
	Peak on-state voltage	V_{TM}	$I_{TM} = 100\text{mA}$	—	1.7	3.0	V
	Holding current	I_H	—	—	1.0	—	mA
	Critical rate of rise of off-state voltage	dv/dt	$V_{in} = 240\text{Vrms}, T_a = 85^\circ\text{C}$ (Note3)	—	500	—	$\text{V}/\mu\text{s}$
	Critical rate of rise of commutating voltage	$dv/dt(c)$	$V_{in} = 60\text{Vrms}, I_T = 15\text{mA}$ (Note3)	—	0.2	—	$\text{V}/\mu\text{s}$

Coupled Electrical Characteristics (Ta=25°C)

Characteristic	Symbol	Test Condition	Min.	Typ.	Max.	Unit
Trigger LED current	I_{FT}	$V_T = 6\text{V}$	—	5	10	mA
Capacitance (input to output)	C_S	$V_S = 0, f=1\text{MHz}$	—	0.8	—	pF
Isolation resistance	R_S	$V_S = 500\text{V}$	1×10^{12}	10^{14}	—	Ω
Isolation voltage	BV_S	AC, 1minute	5000	—	—	Vrms
		AC, 1second, in oil	—	10000	—	Vrms
		DC, 1minute, in oil	—	10000	—	Vdc

(Note 3) dv/dt test circuit

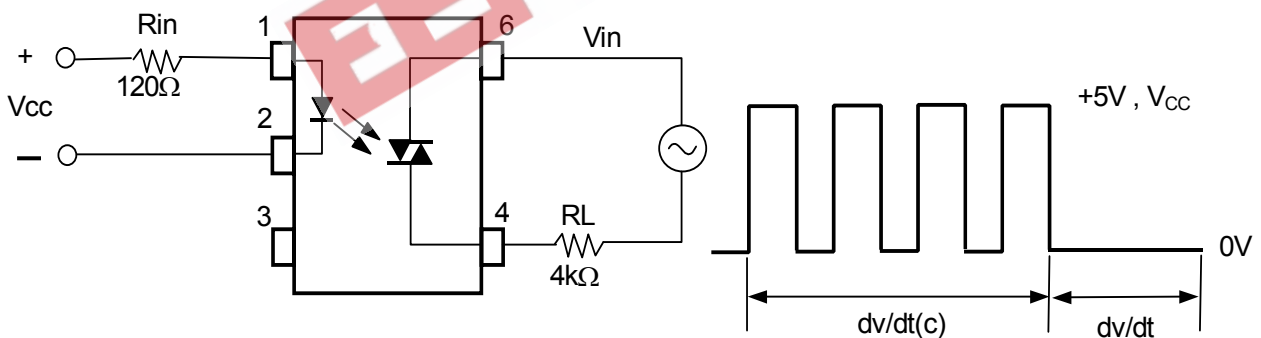

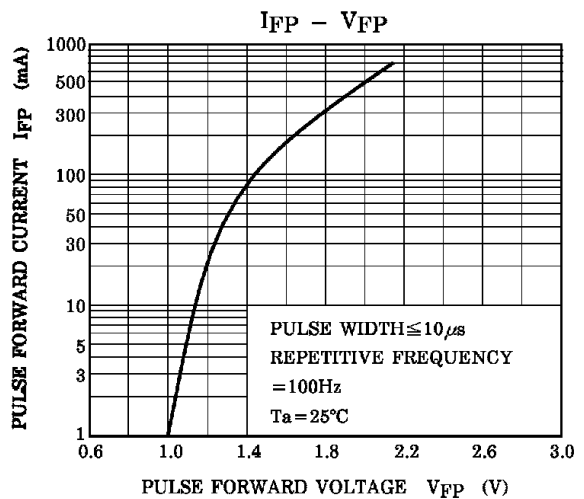
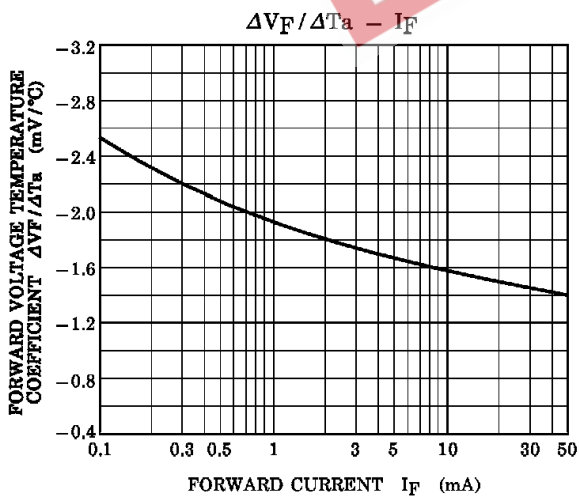
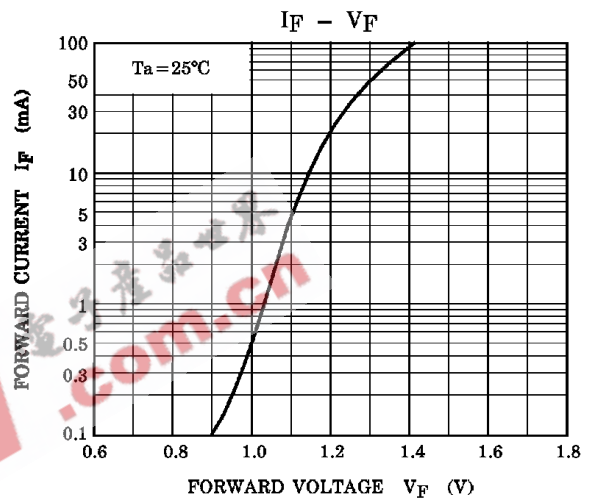
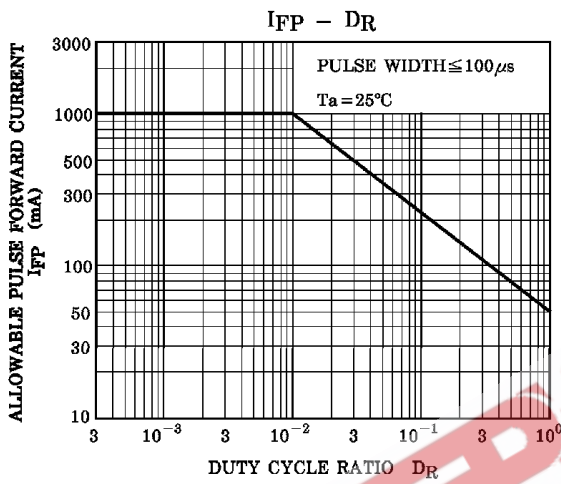
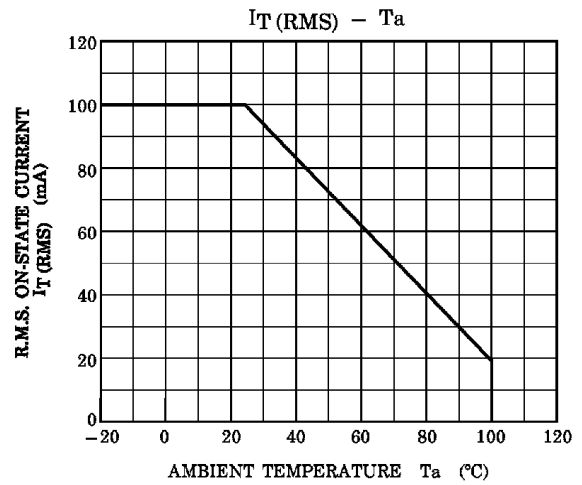
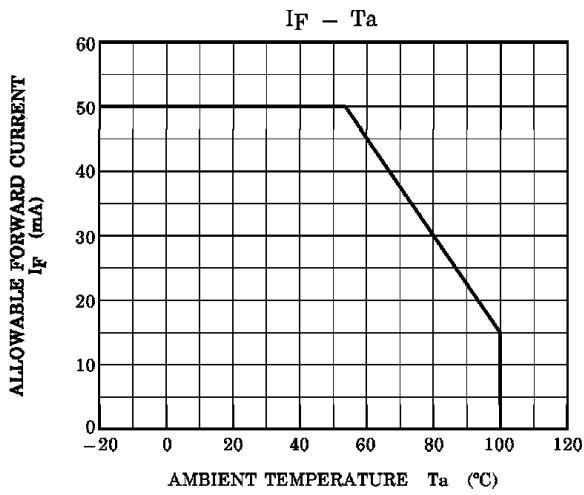

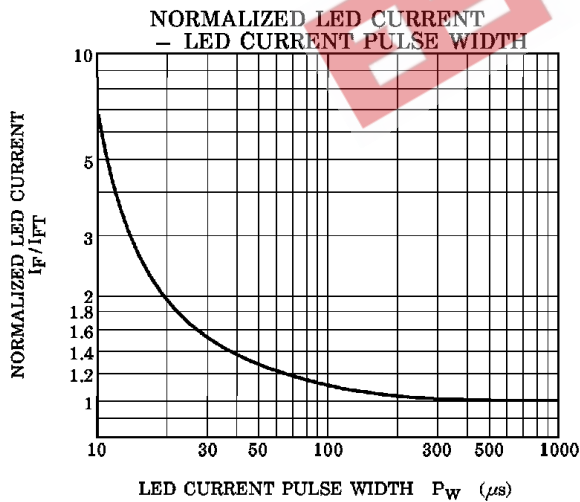
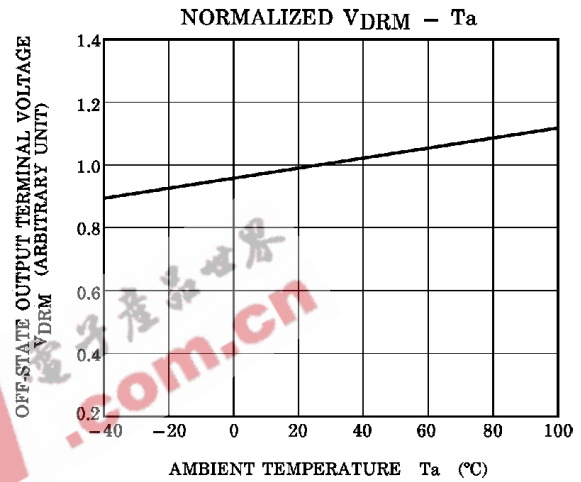
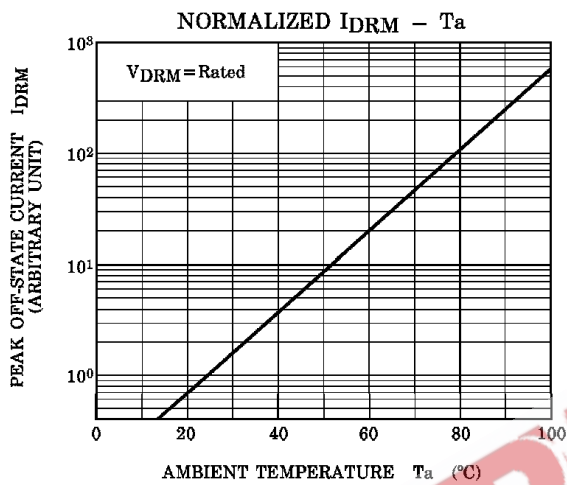
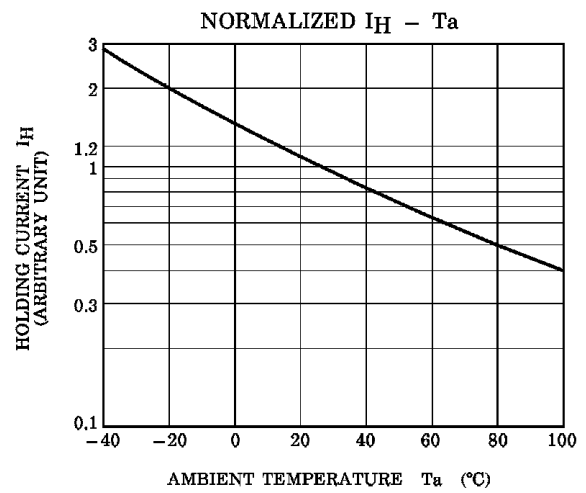
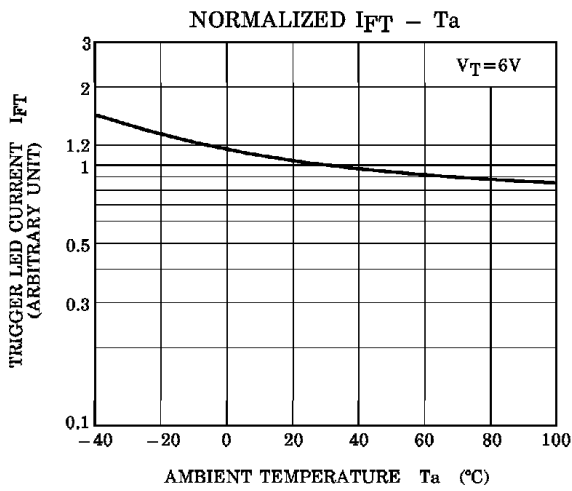

RESTRICTIONS ON PRODUCT USE

20070701-EN

- The information contained herein is subject to change without notice.
- TOSHIBA is continually working to improve the quality and reliability of its products. Nevertheless, semiconductor devices in general can malfunction or fail due to their inherent electrical sensitivity and vulnerability to physical stress. It is the responsibility of the buyer, when utilizing TOSHIBA products, to comply with the standards of safety in making a safe design for the entire system, and to avoid situations in which a malfunction or failure of such TOSHIBA products could cause loss of human life, bodily injury or damage to property.
In developing your designs, please ensure that TOSHIBA products are used within specified operating ranges as set forth in the most recent TOSHIBA products specifications. Also, please keep in mind the precautions and conditions set forth in the "Handling Guide for Semiconductor Devices," or "TOSHIBA Semiconductor Reliability Handbook" etc.
- The TOSHIBA products listed in this document are intended for usage in general electronics applications (computer, personal equipment, office equipment, measuring equipment, industrial robotics, domestic appliances, etc.). These TOSHIBA products are neither intended nor warranted for usage in equipment that requires extraordinarily high quality and/or reliability or a malfunction or failure of which may cause loss of human life or bodily injury ("Unintended Usage"). Unintended Usage include atomic energy control instruments, airplane or spaceship instruments, transportation instruments, traffic signal instruments, combustion control instruments, medical instruments, all types of safety devices, etc.. Unintended Usage of TOSHIBA products listed in this document shall be made at the customer's own risk.
- The products described in this document shall not be used or embedded to any downstream products of which manufacture, use and/or sale are prohibited under any applicable laws and regulations.
- The information contained herein is presented only as a guide for the applications of our products. No responsibility is assumed by TOSHIBA for any infringements of patents or other rights of the third parties which may result from its use. No license is granted by implication or otherwise under any patents or other rights of TOSHIBA or the third parties.
- GaAs(Gallium Arsenide) is used in this product. The dust or vapor is harmful to the human body. Do not break, cut, crush or dissolve chemically.
- Please contact your sales representative for product-by-product details in this document regarding RoHS compatibility. Please use these products in this document in compliance with all applicable laws and regulations that regulate the inclusion or use of controlled substances. Toshiba assumes no liability for damage or losses occurring as a result of noncompliance with applicable laws and regulations.