

TOSHIBA Photointerrupter Infrared LED + Phototransistor

TLP833(F)

Lead(Pb)-Free

Copiers, Printers, Fax Machines

VCRS, Microwave Ovens, Air Conditioners

Automatic Vending Machines

Various Position Detection Sensors

The TLP833(F) is a photointerrupter which incorporates a high radiant power GaAs LED and a fast-response Si phototransistor. The package has a deep gap.

- Package with deep gap (gap: 12 mm)
- Designed for direct mounting on printed circuit boards (positioning pins included).
- Gap: 5mm
- Resolution: Slit width 0.5mm
- High current transfer ratio: $I_C/I_F = 5\%$ (min)
- High temperature operation: $T_{opr} = 95^\circ\text{C}$ (max)
- Package material: Polybutylene terephthalate (UL94-V-0)
- Detector impermeable to visible light

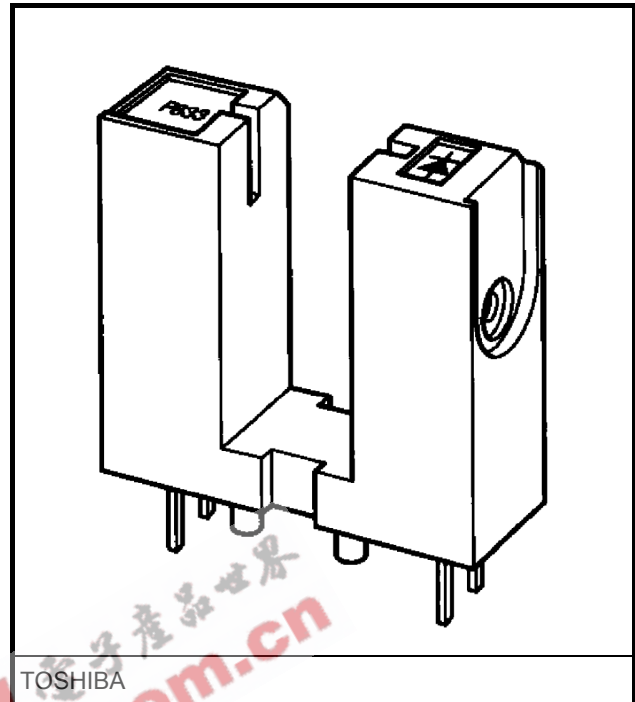

Weight: 1g (typ.)

Absolute Maximum Ratings ($T_a = 25^\circ\text{C}$)

Characteristic		Symbol	Rating	Unit
LED	Forward current	I_F	50	mA
	Forward current derating	$\Delta I_F/^\circ\text{C}$	$25^\circ\text{C} < T_a \leq 85^\circ\text{C}$	-0.33
			$T_a > 85^\circ\text{C}$	-2
Reverse voltage		V_R	5	V
Detector	Collector-emitter voltage	V_{CEO}	35	V
	Emitter-collector voltage	V_{ECO}	5	V
	Collector power dissipation	P_C	75	mW
	Collector power dissipation derating ($T_a > 25^\circ\text{C}$)	$\Delta P_C/^\circ\text{C}$	-1	mW/ $^\circ\text{C}$
Collector current		I_C	50	mA
Operating temperature range		T_{opr}	-30~85	$^\circ\text{C}$
Storage temperature range		T_{stg}	-40~100	$^\circ\text{C}$
Soldering temperature (5 s)		T_{sol}	260	$^\circ\text{C}$

Note: Using continuously under heavy loads (e.g. the application of high temperature/current/voltage and the significant change in temperature, etc.) may cause this product to decrease in the reliability significantly even if the operating conditions (i.e. operating temperature/current/voltage, etc.) are within the absolute maximum ratings and the operating ranges.

Please design the appropriate reliability upon reviewing the Toshiba Semiconductor Reliability Handbook ("Handling Precautions"/"Derating Concept and Methods") and individual reliability data (i.e. reliability test report and estimated failure rate, etc).

Markings

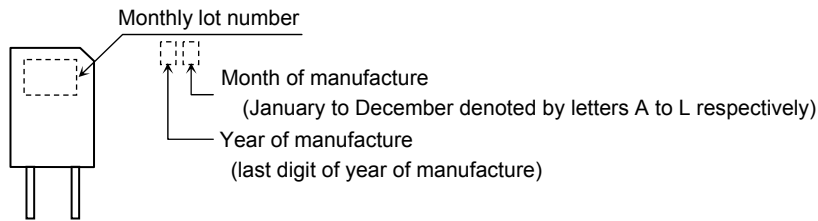

Operating Ranges

Characteristic	Symbol	Min	Typ.	Max	Unit
Supply voltage	V_{CC}	—	5	24	V
Forward current	I_F	—	—	25	mA
Operating temperature	T_{opr}	-10	—	75	°C

Optical Electrical Characteristics ($T_a = 25^\circ\text{C}$)

Characteristic		Symbol	Test Condition	Min	Typ.	Max	Unit
LED	Forward voltage	V_F	$I_F = 10\text{mA}$	1.00	1.15	1.30	V
	Reverse current	I_R	$V_R = 5\text{V}$	—	—	10	μA
	Peak emission wavelength	λ_P	$I_F = 10\text{mA}$	—	940	—	nm
Detector	Dark current	$I_D (I_{CEO})$	$V_{CE} = 24\text{V}, I_F = 0$	—	—	0.1	μA
	Peak sensitivity wavelength	λ_P	—	—	870	—	nm
Coupled	Current transfer ratio	I_C/I_F	$V_{CE} = 2\text{V}, I_F = 10\text{mA}$	5	—	100	%
	Collector-emitter saturation voltage	$V_{CE(sat)}$	$I_F = 20\text{mA}, I_C = 0.5\text{mA}$	—	0.1	0.35	V
	Rise time	t_r	$V_{CC} = 5\text{V}, I_C = 1\text{mA}$	—	15	—	μs
	Fall time	t_f	$R_L = 1\text{k}\Omega$ (Note)	—	15	—	

(Note): Switching time measurement circuit and waveform

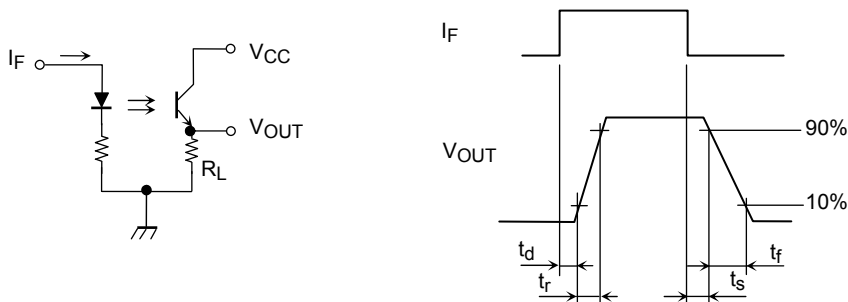

Precautions

1. Clean only the soldered part of the leads. Do not immerse the entire package in the cleaning solvent.
2. The package is made of polybutylene-terephthalate. Oil or chemicals may cause the package to melt or crack. Care must be taken in relation to the environment in which the device is to be installed.
3. Mount the device on a level surface.
4. Keep the device away from external light. Although the phototransistor is of low optical sensitivity, the device may malfunction if external light with a wavelength of 700 nm or more is allowed to impinge on it.
5. Conversion efficiency falls over time due to the current which flows in the infrared LED. When designing a circuit, take into account this change in conversion efficiency over time.
The ratio of fluctuation in conversion efficiency to fluctuation in infrared LED optical output is 1 : 1.

$$\frac{I_C/I_F(t)}{I_C/I_F(0)} = \frac{P_O(t)}{P_O(0)}$$

EEPW 电子产品世界
.com.cn

Package Dimensions

Unit: mm

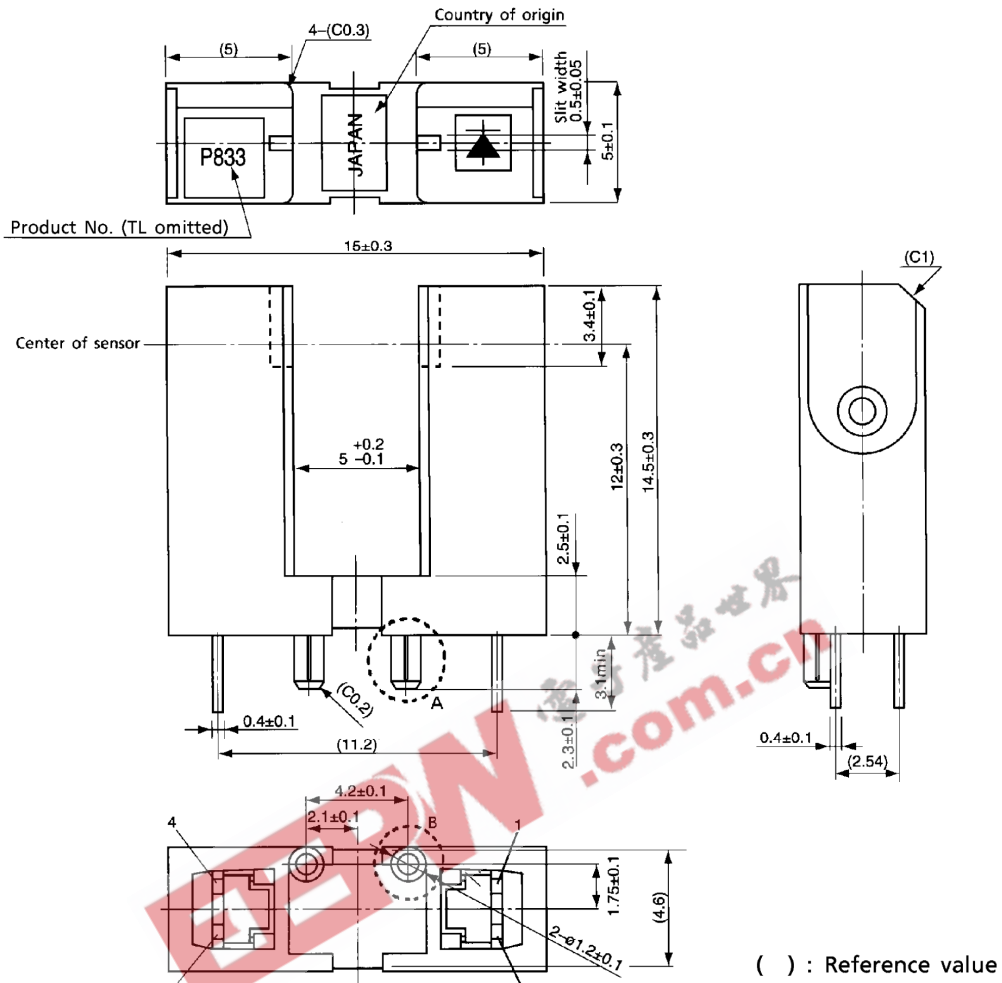

Weight: 1 g (typ.)

Pin Connection

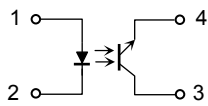

1. Anode
2. Cathode
3. Collector
4. Emitter

A

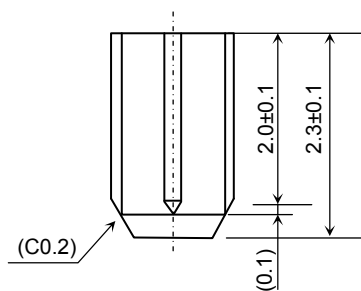

B

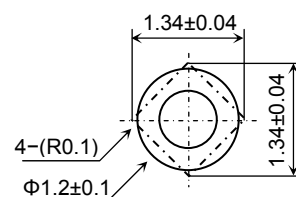

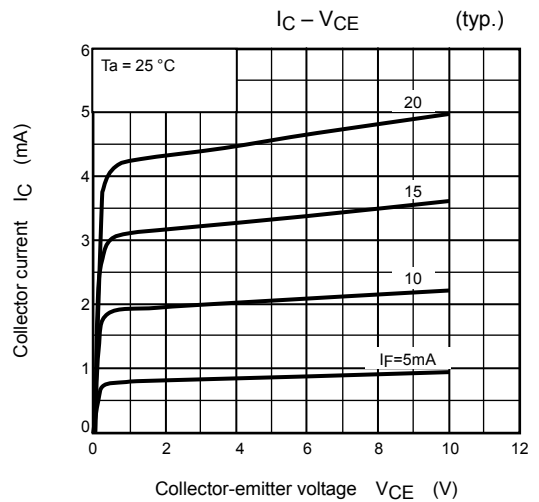
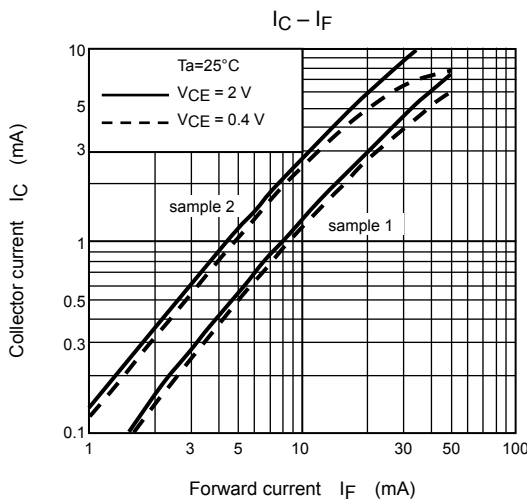
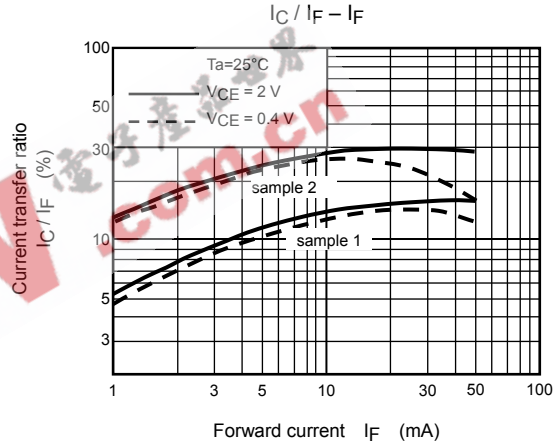
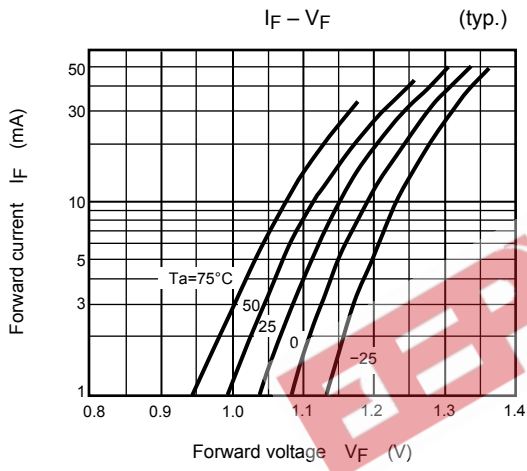
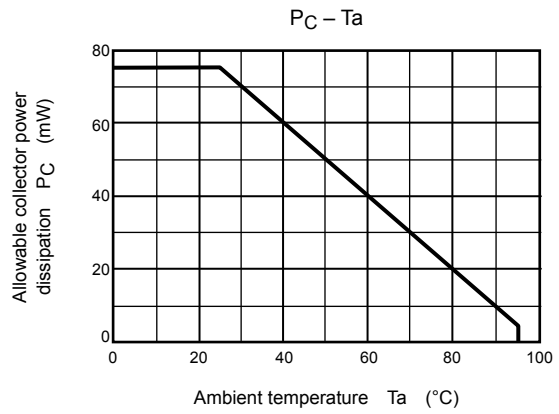
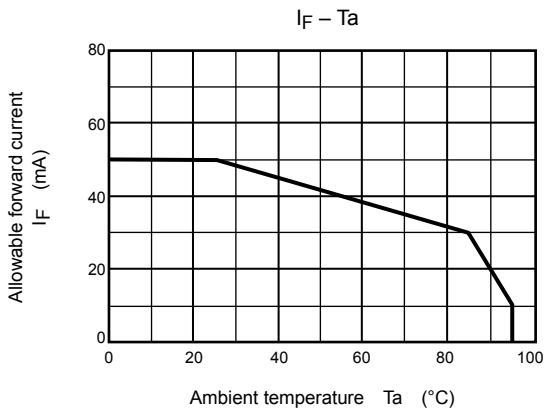

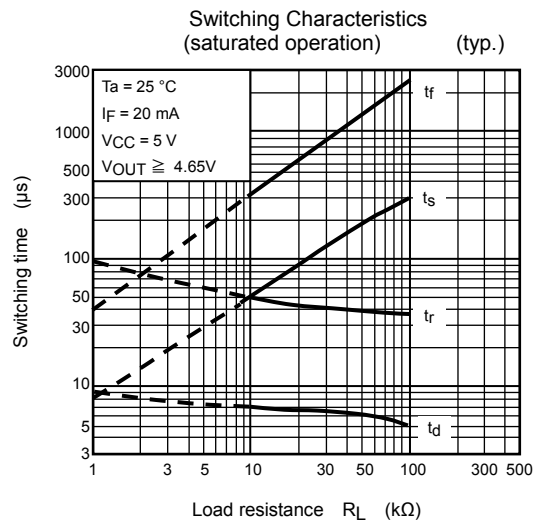
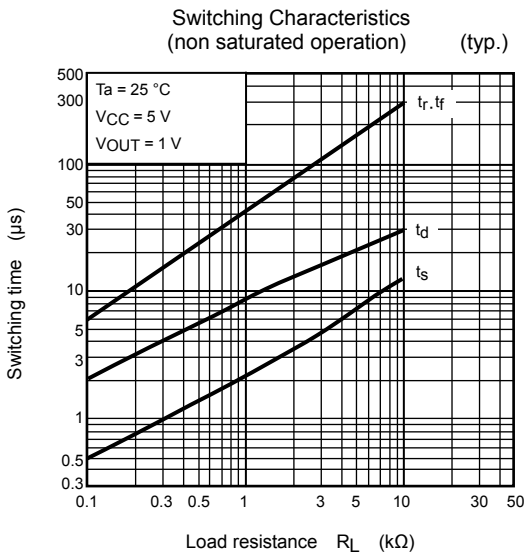
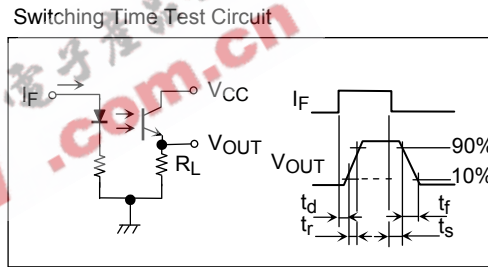
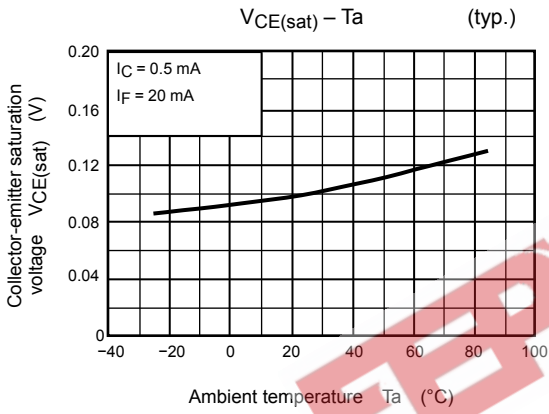
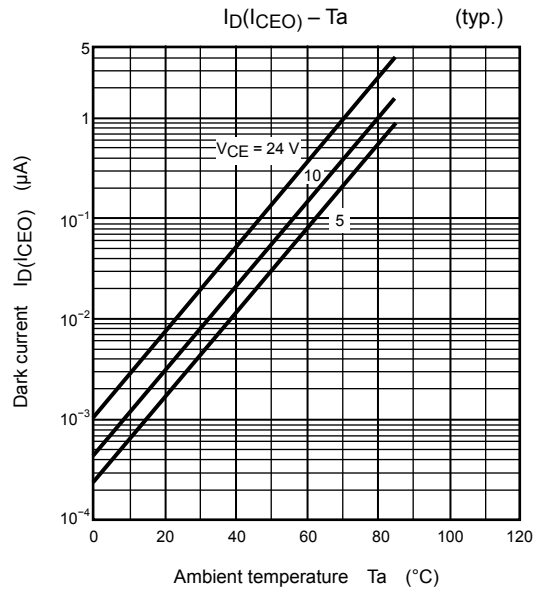
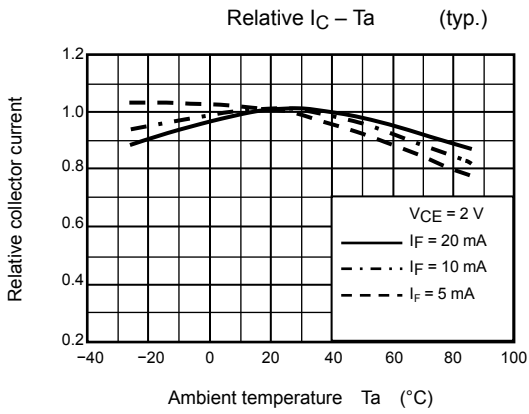

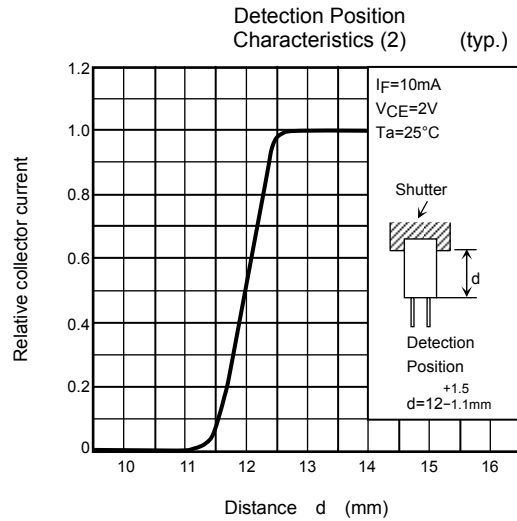
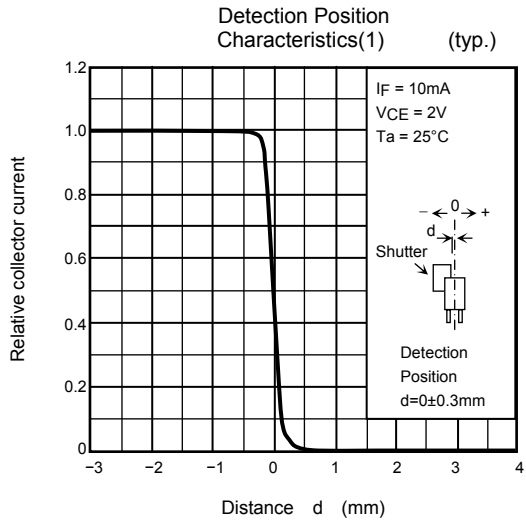

Relative Positioning Of Shutter And Device

For normal operation position the shutter and the device as shown in the figure below. By considering the device's detection direction characteristic and switching time, determine the shutter slit width and pitch.

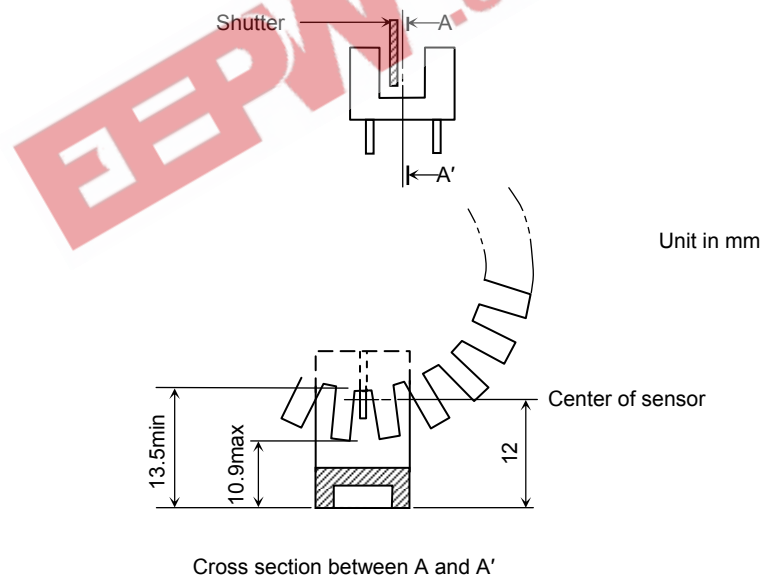

- The information contained herein is subject to change without notice.

- TO SHIBA is continually working to improve



the quality an