



**TS941  
TS942  
TS944**

## OUTPUT RAIL TO RAIL MICROPOWER OPERATIONAL AMPLIFIERS

- RAIL TO RAIL **OUTPUT VOLTAGE SWING**
- **MICROPOWER CONSUMPTION (1.2μA)**
- **SINGLE SUPPLY OPERATION (2.7V to 10V)**
- **CMOS INPUTS**
- **ULTRA LOW INPUT BIAS CURRENT (1pA)**
- **ESD PROTECTION (2kV)**
- **LATCH-UP IMMUNITY (Class A)**
- **AVAILABLE IN SOT23-5 MICROPACKAGE**

### DESCRIPTION

The TS94x (Single, Dual & Quad) is Operational Amplifier characterized for 2.7V to 10V operation over -40°C to +85°C temperature range.

It is exhibiting an excellent consumption - 1.2μA, while featuring 10kHz gain bandwidth product, 1.5mA output capability and output Rail to Rail operation - 2.85V typ @ 3V with RL=10kΩ.

The TS94x Op-Amp is ideal for battery-powered systems, where very low supply current and output Rail to Rail are required. Its very low - 1pA typ input bias current and constant supply current over supply voltage enhance TS94x's performance near the end of the life battery charge.

### APPLICATION

- Battery-powered systems (Alarm)
- Portable communication systems (Paggers)
- Smoke/gas/fire detectors
- Instrumentation & sensing
- PH Meter

### ORDER CODE

Part Number	Temperature Range	Package				SOT23 Marking
		N	D	P	L	
TS941I TS941AI TS941BI	-40, +85°C		•		•	K201 K202 K203
TS942I TS942AI TS942BI	-40, +85°C	•	•	•		
TS944I TS944AI TS944BI	-40, +85°C	•	•	•		

**N** = Dual in Line Package (DIP)  
**D** = Small Outline Package (SO) - also available in Tape & Reel (DT)  
**P** = Thin Shrink Small Outline Package (TSSOP) - only available in Tape & Reel (PT)  
**L** = Tiny Package (SOT23-5) - only available in Tape & Reel (LT)

### PIN CONNECTIONS (top view)

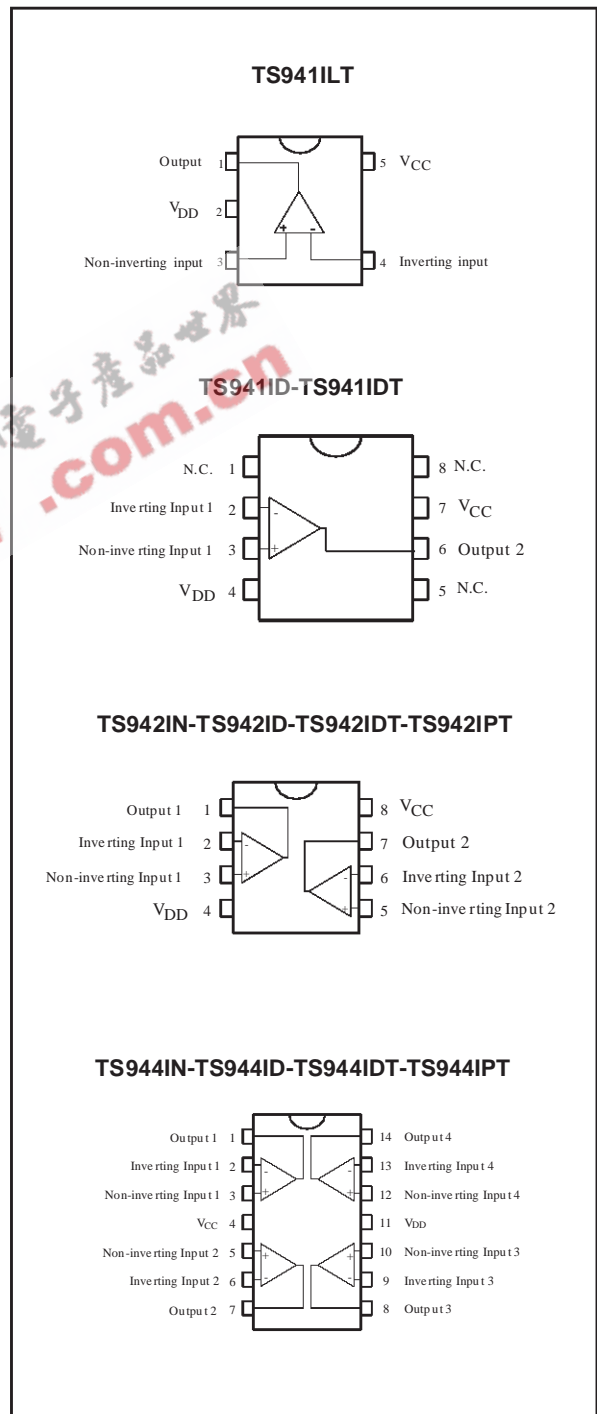

## ABSOLUTE MAXIMUM RATINGS

Symbol	Parameter	Value	Unit
$V_{CC}$	Supply voltage <sup>1)</sup>	12	V
$V_{id}$	Differential Input Voltage <sup>2)</sup>	$\pm 12$	V
$V_{in}$	Input Voltage Range <sup>3)</sup>	-0.3 to 12.3	V
$T_{oper}$	Operating Free Air Temperature Range	-40 to + 85	°C
$T_{std}$	Storage Temperature Range	-65 to +150	°C
$T_j$	Maximum Junction Temperature	150	°C
$R_{thjc}$	Thermal Resistance Junction to Case <sup>4)</sup>		°C/W
	SOT23-5	81	
	DIP8	42	
	DIP14	32	
	SO8	28	
	SO14	22	
	TSSOP8	26	
	TSSOP14	21	
$R_{thja}$	Thermal Resistance Junction to Ambient - SOT23-5	256	°C/W
ESD	Human Body Model	2	kV
	Latch-up Immunity	Class A	
	Lead Temperature (soldering, 10sec)	260	°C

1. All voltages values, except differential voltage are with respect to network terminal.

2. Differential voltages are non-inverting input terminal with respect to the inverting input terminal.

3. The magnitude of input and output voltages must never exceed  $V_{CC} + 0.3V$ .

4. Short-circuits can cause excessive heating and destructive dissipation.

## OPERATING CONDITIONS

Symbol	Parameter	Value	Unit
$V_{CC}$	Supply Voltage	2.7 to 10	V
$V_{icm}$	Common Mode Input Voltage Range	$V_{CC}^- - 0.2$ to $V_{CC}^+ - 1.3$	V

## TS941-TS942-TS944

### ELECTRICAL CHARACTERISTICS

$V_{CC} = +3V$ ,  $V_{EE} = 0V$ ,  $R_L$  connected to  $V_{CC/2}$ ,  
 $T_{amb} = 25^{\circ}C$  (unless otherwise specified)

Symbol	Parameter	Min.	Typ.	Max.	Unit
$V_{io}$	Input Offset Voltage TS941/2/4 TS941/2/4A TS941/2/4B			10 5 2	mV
$\Delta V_{io}$	Input Offset Voltage Drift		7		$\mu V/^{\circ}C$
$I_{io}$	Input Offset Current <sup>1)</sup>		1	100	pA
$I_{ib}$	Input Bias Current <sup>1)</sup>		1	150	pA
CMR	Common Mode Rejection Ratio		85		dB
SVR	Supply Voltage Rejection Ratio		85		dB
$A_{vd}$	Large Signal Voltage Gain $V_O = 2V_{pp}$ $R_L = 1M\Omega$		100		dB
$V_{OH}$	High Level Output Voltage $V_{ID} = 100mV$ $R_L = 1M\Omega$ $R_L = 10k\Omega$	2.9 2.79	2.99 2.85		V
$V_{OL}$	Low Level Output Voltage $V_{ID} = -100mV$ $R_L = 1M\Omega$ $R_L = 10k\Omega$		5 100	50 210	mV
$I_o$	Output Source Current $V_{ID} = 100mV$ , $V_O = V_{DD}$ Output Sink Current $V_{ID} = -100mV$ , $V_O = V_{CC}$		1.5 1.3		mA
$I_{CC}$	Supply Current (per amplifier) $A_{VCL} = 1$ , no load		1.2	2	$\mu A$
GBP	Gain Bandwidth Product $R_L = 1M\Omega$ , $C_L = 50pF$		10		kHz
SR	Slew Rate $R_L = 1M\Omega$ , $C_L = 50pF$		4		V/ms
$\phi_m$	Phase Margin $C_L = 50pF$		65		Degrees

1. Maximum values including unavoidable inaccuracies of the industrial test.

**ELECTRICAL CHARACTERISTICS**

$V_{CC} = +5V$ ,  $V_{EE} = 0V$ ,  $R_L$  connected to  $V_{CC/2}$ ,  
 $T_{amb} = 25^\circ C$  (unless otherwise specified)

Symbol	Parameter	Min.	Typ.	Max.	Unit
$V_{io}$	Input Offset Voltage TS941/2/4 TS941/2/4A TS941/2/4B			10 5 2	mV
$\Delta V_{io}$	Input Offset Voltage Drift		7		$\mu V/^\circ C$
$I_{io}$	Input Offset Current <sup>1)</sup>		1	100	pA
$I_{ib}$	Input Bias Current <sup>1)</sup>		1	150	pA
CMR	Common Mode Rejection Ratio		85		dB
SVR	Supply Voltage Rejection Ratio		85		dB
$A_{vd}$	Large Signal Voltage Gain $V_O = 2V_{pp}$ $R_L = 1M\Omega$		100		dB
$V_{OH}$	High Level Output Voltage $V_{ID} = 100mV$ $R_L = 1M\Omega$ $R_L = 10k\Omega$	4.9 4.79	4.99 4.85		V
$V_{OL}$	Low Level Output Voltage $V_{ID} = -100mV$ $R_L = 1M\Omega$ $R_L = 10k\Omega$		5 100		mV
$I_o$	Output Source Current $V_{ID} = 100mV$ , $V_O = V_{DD}$ Output Sink Current $V_{ID} = -100mV$ , $V_O = V_{CC}$		5 6		mA
$I_{CC}$	Supply Current (per amplifier) $A_{VCL} = 1$ , no load		1.2	2	$\mu A$
GBP	Gain Bandwidth Product $R_L = 1M\Omega$ , $C_L = 50pF$		10		kHz
SR	Slew Rate $R_L = 1M\Omega$ , $C_L = 50pF$		5		V/ms
$\phi_m$	Phase Margin $C_L = 50pF$		65		Degrees

1. Maximum values including unavoidable inaccuracies of the industrial test.

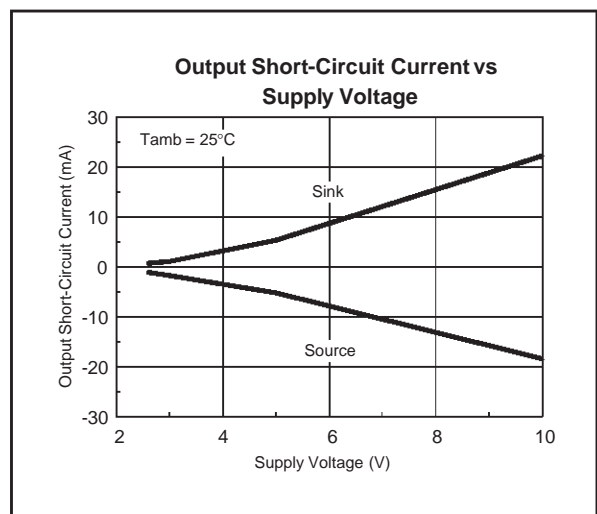
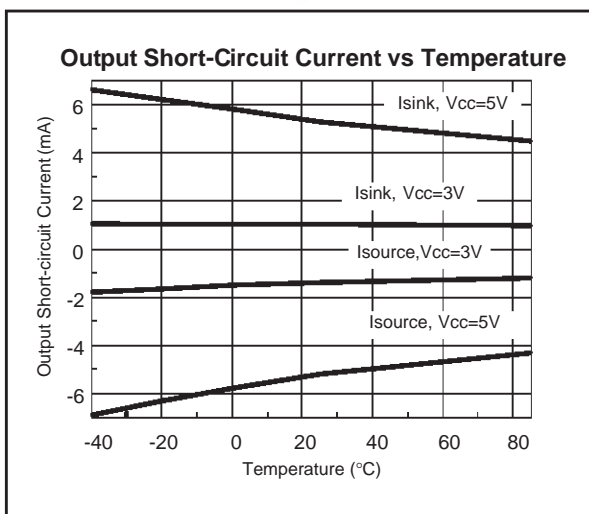
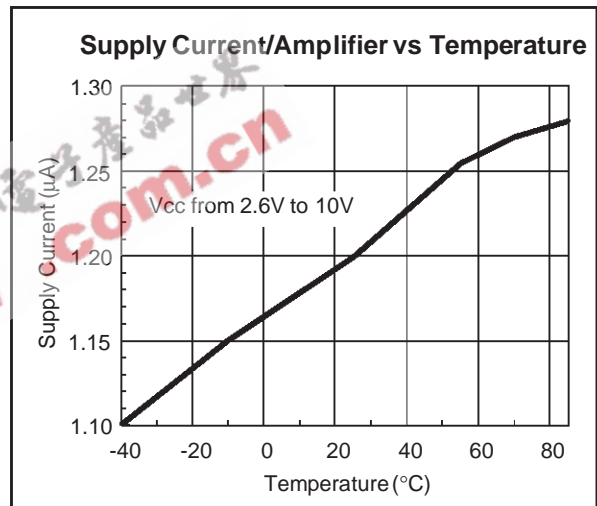
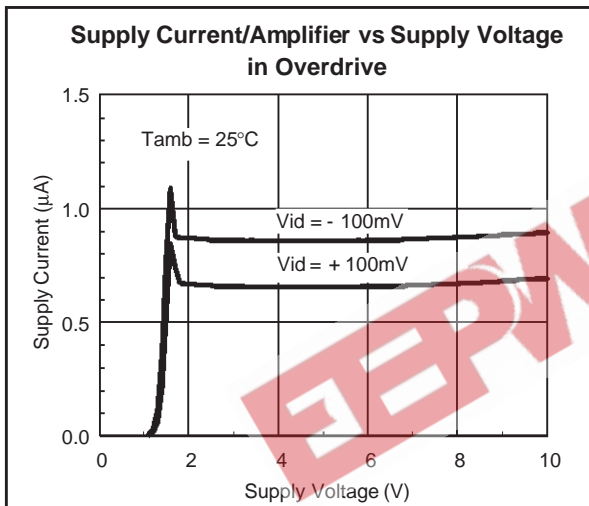
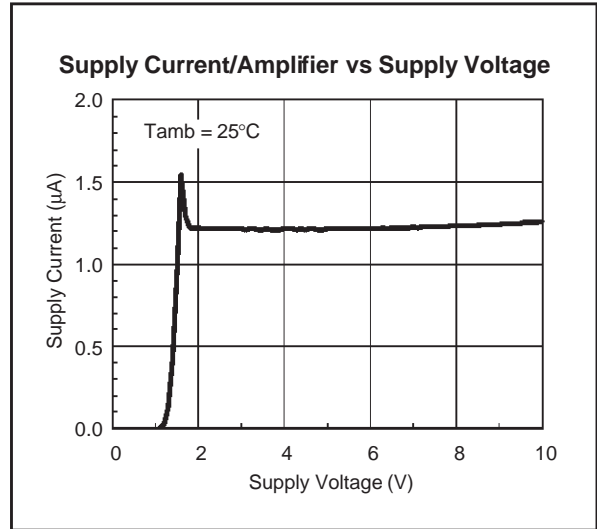
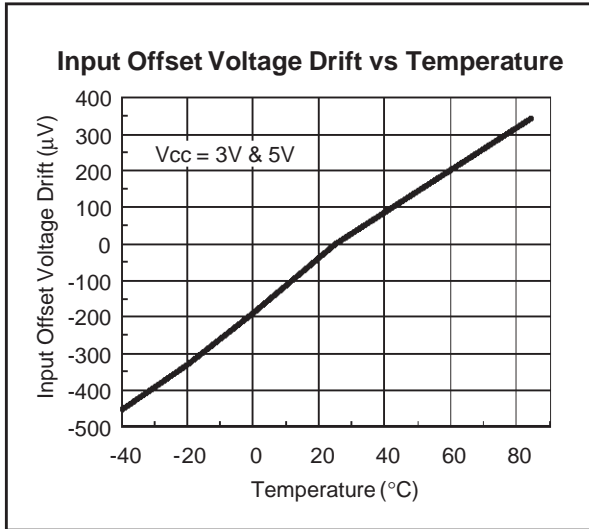

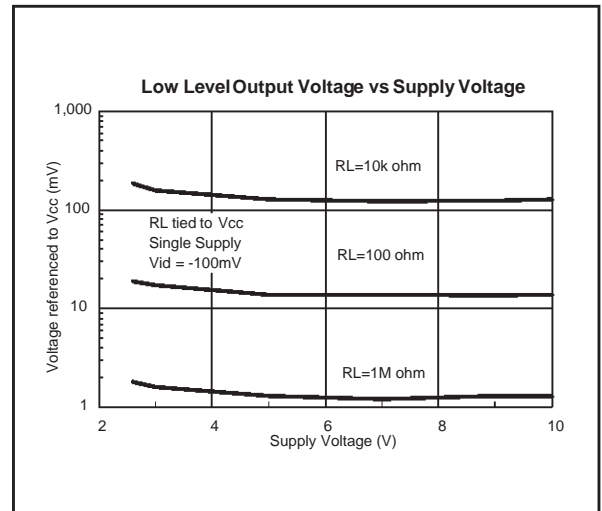
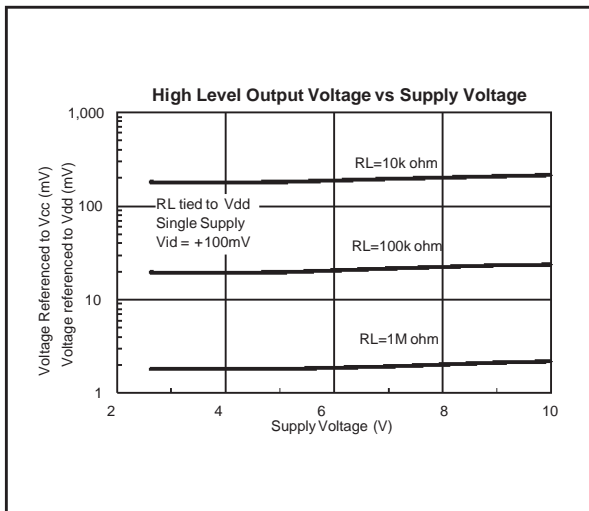
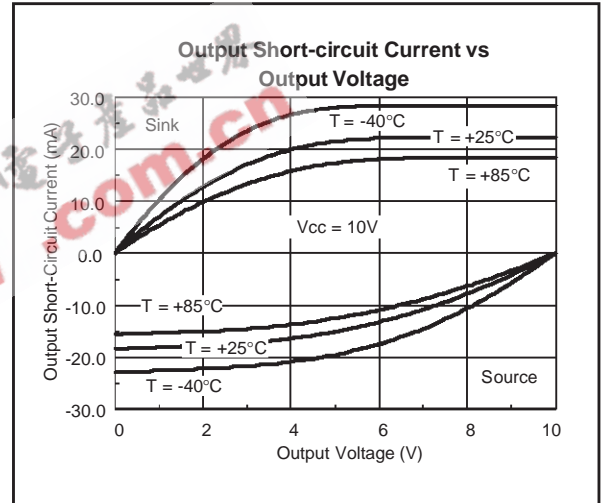
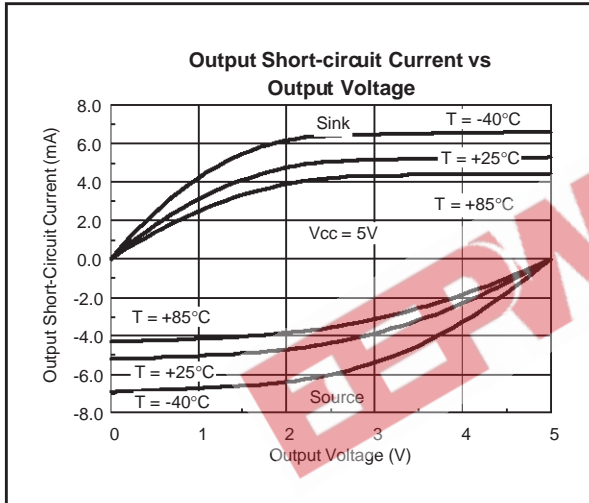
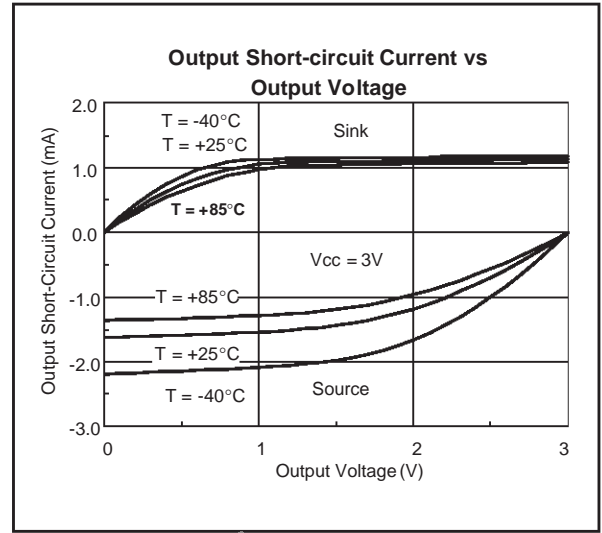
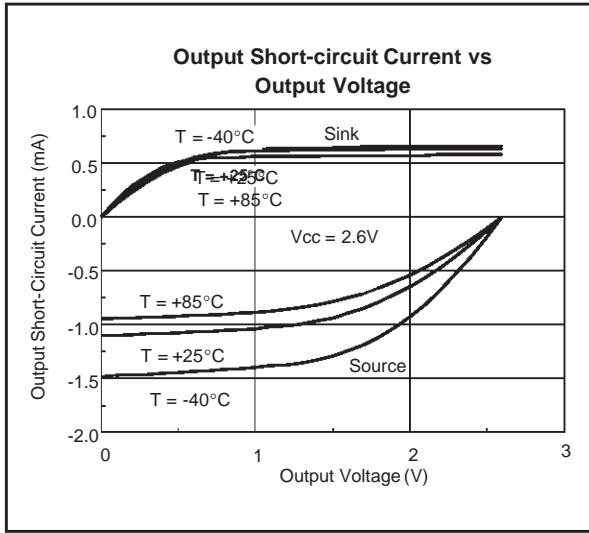

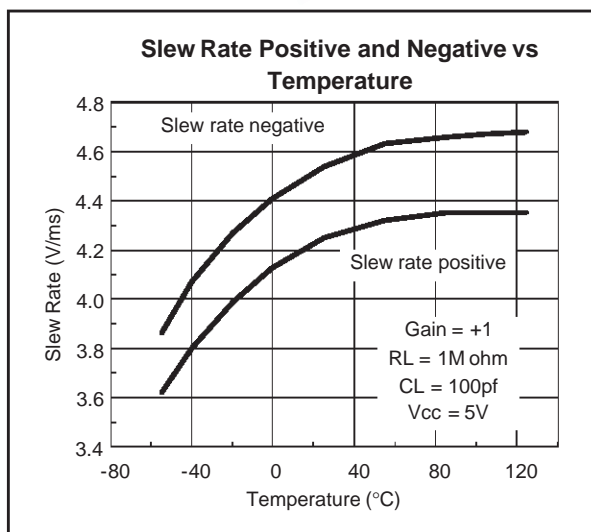
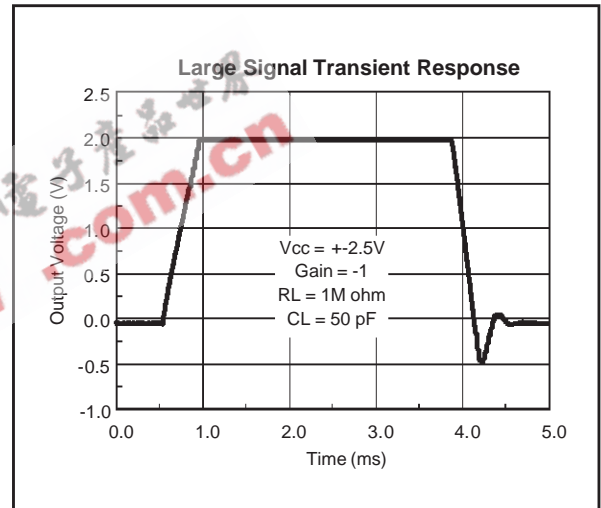
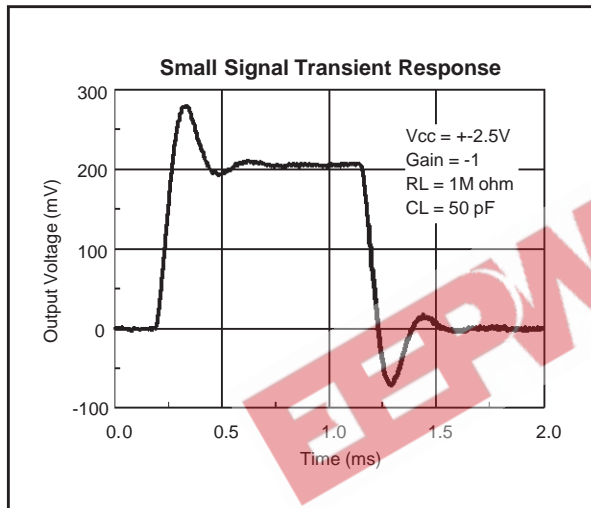
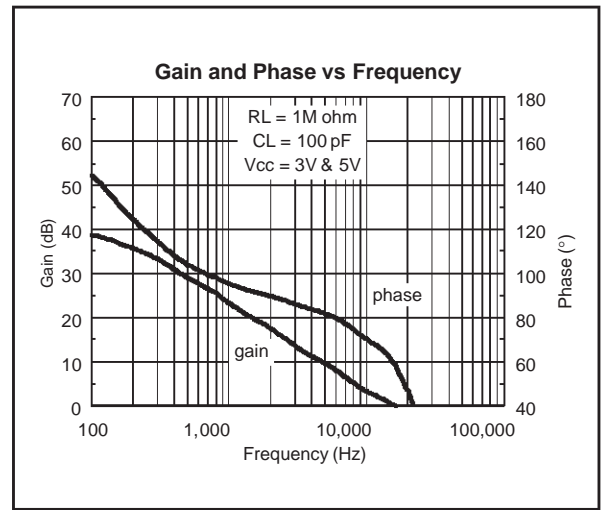
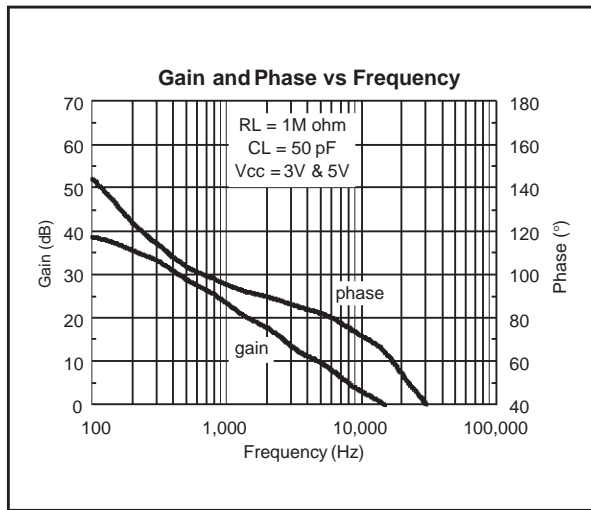

TS942IN

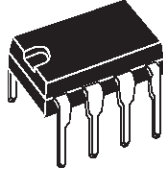

**PACKAGE MECHANICAL DATA**  
8 PINS - PLASTIC PACKAGE

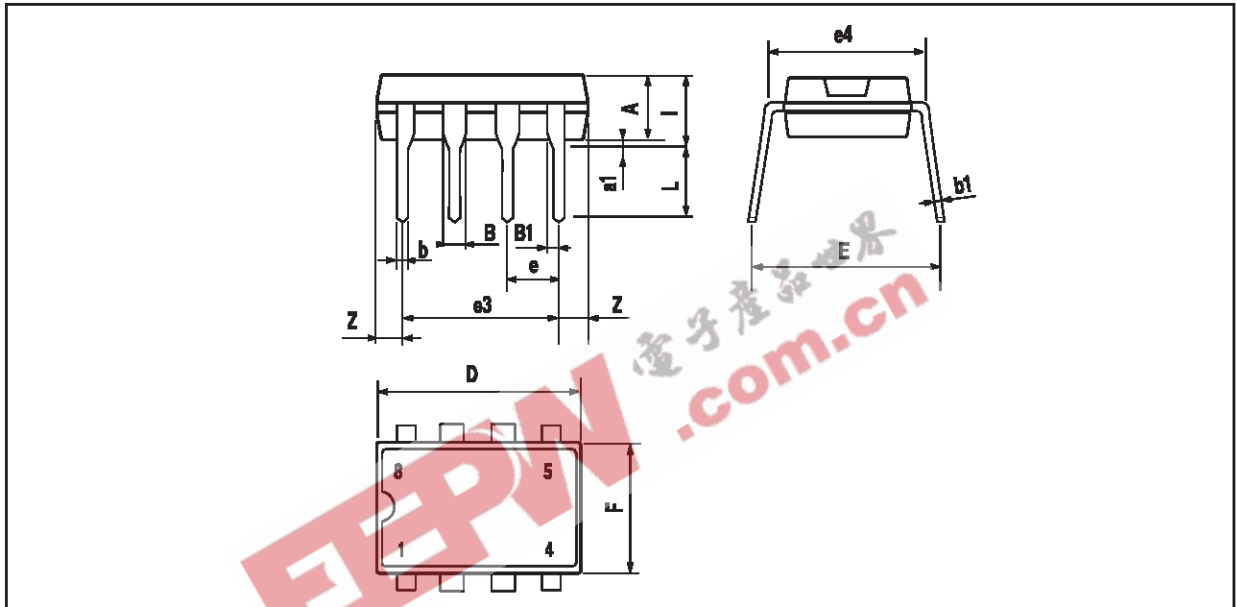

Dim.	Millimeters			Inches		
	Min.	Typ.	Max.	Min.	Typ.	Max.
A		3.32			0.131	
a1	0.51			0.020		
B	1.15		1.65	0.045		0.065
b	0.356		0.55	0.014		0.022
b1	0.204		0.304	0.008		0.012
D			10.92			0.430
E	7.95		9.75	0.313		0.384
e		2.54			0.100	
e3		7.62			0.300	
e4		7.62			0.300	
F			6.6			0.260
i			5.08			0.200
L	3.18		3.81	0.125		0.150
Z			1.52			0.060



TS941-TS942-TS944

TS941ID - TS942ID

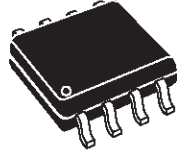

**PACKAGE MECHANICAL DATA**  
8 PINS - PLASTIC MICROPACKAGE (SO)

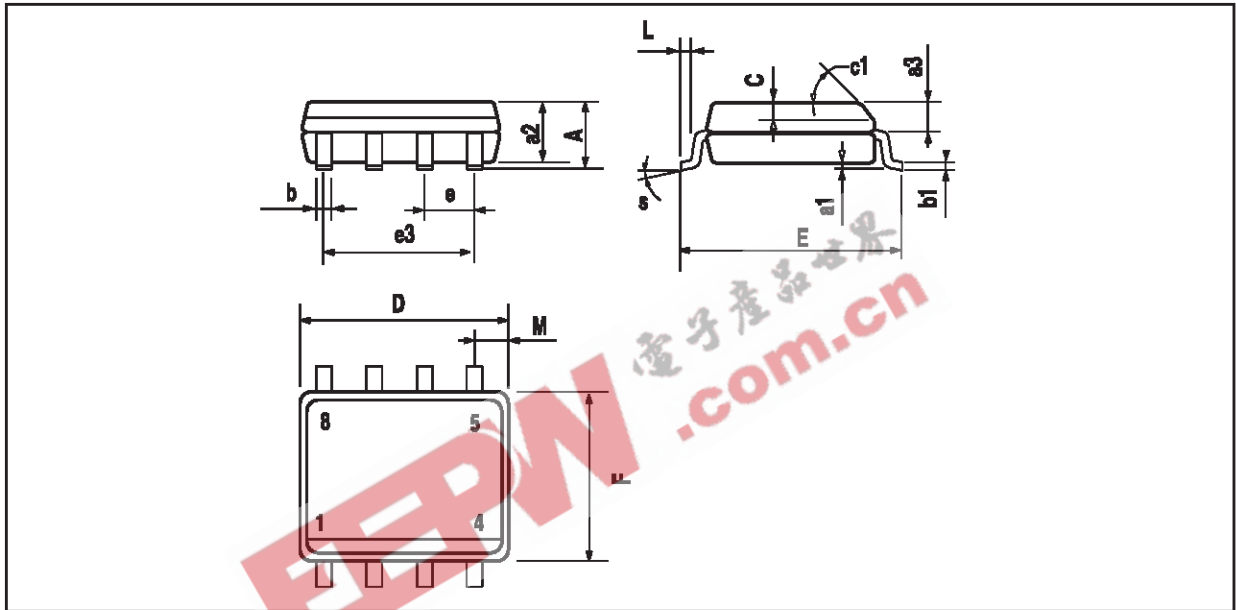

Dim.	Millimeters			Inches		
	Min.	Typ.	Max.	Min.	Typ.	Max.
A			1.75			0.069
a1	0.1		0.25	0.004		0.010
a2			1.65			0.065
a3	0.65		0.85	0.026		0.033
b	0.35		0.48	0.014		0.019
b1	0.19		0.25	0.007		0.010
C	0.25		0.5	0.010		0.020
c1	45° (typ.)					
D	4.8		5.0	0.189		0.197
E	5.8		6.2	0.228		0.244
e		1.27			0.050	
e3		3.81			0.150	
F	3.8		4.0	0.150		0.157
L	0.4		1.27	0.016		0.050
M			0.6			0.024
S	8° (max.)					

TS942IPT

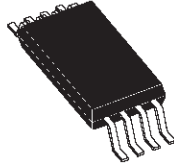

**PACKAGE MECHANICAL DATA**  
8 PINS - THIN SHRINK SMALL OUTLINE PACKAGE

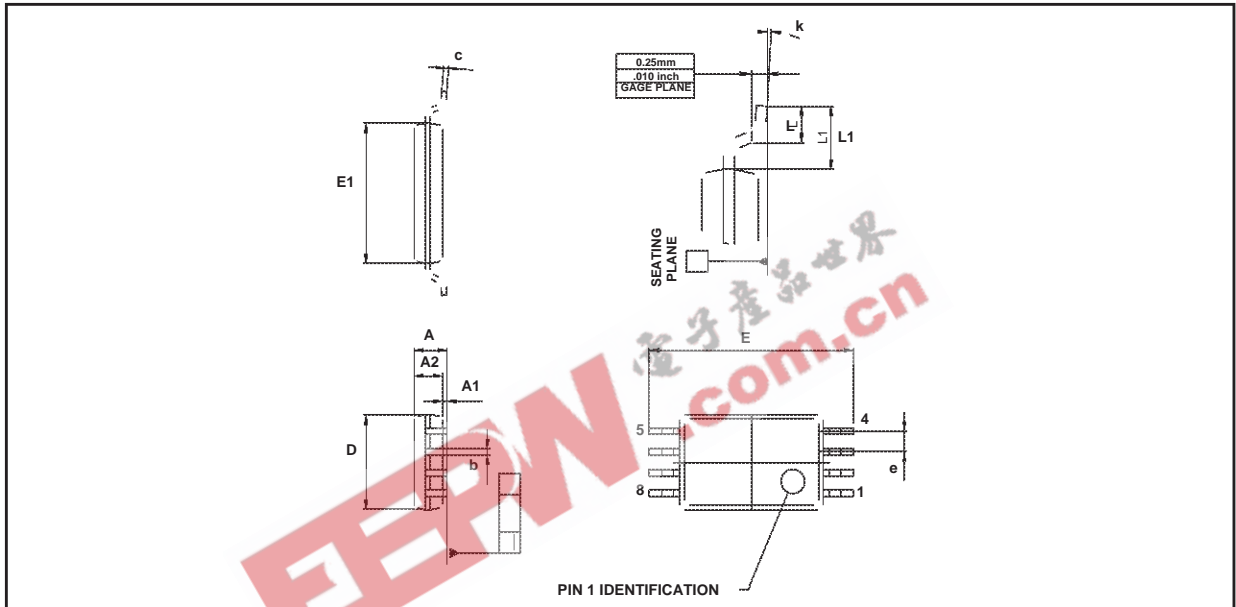

Dim.	Millimeters			Inches		
	Min.	Typ.	Max.	Min.	Typ.	Max.
A			1.20			0.05
A1	0.05		0.15	0.01		0.006
A2	0.80	1.00	1.05	0.031	0.039	0.041
b	0.19		0.30	0.007		0.15
c	0.09		0.20	0.003		0.012
D	2.90	3.00	3.10	0.114	0.118	0.122
E		6.40			0.252	
E1	4.30	4.40	4.50	0.169	0.173	0.177
e		0.65			0.025	
k	0°		8°	0°		8°
l	0.50	0.60	0.75	0.09	0.0236	0.030

TS941-TS942-TS944

TS944IN

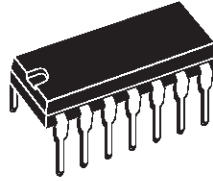

PACKAGE MECHANICAL DATA  
14 PINS - PLASTIC PACKAGE

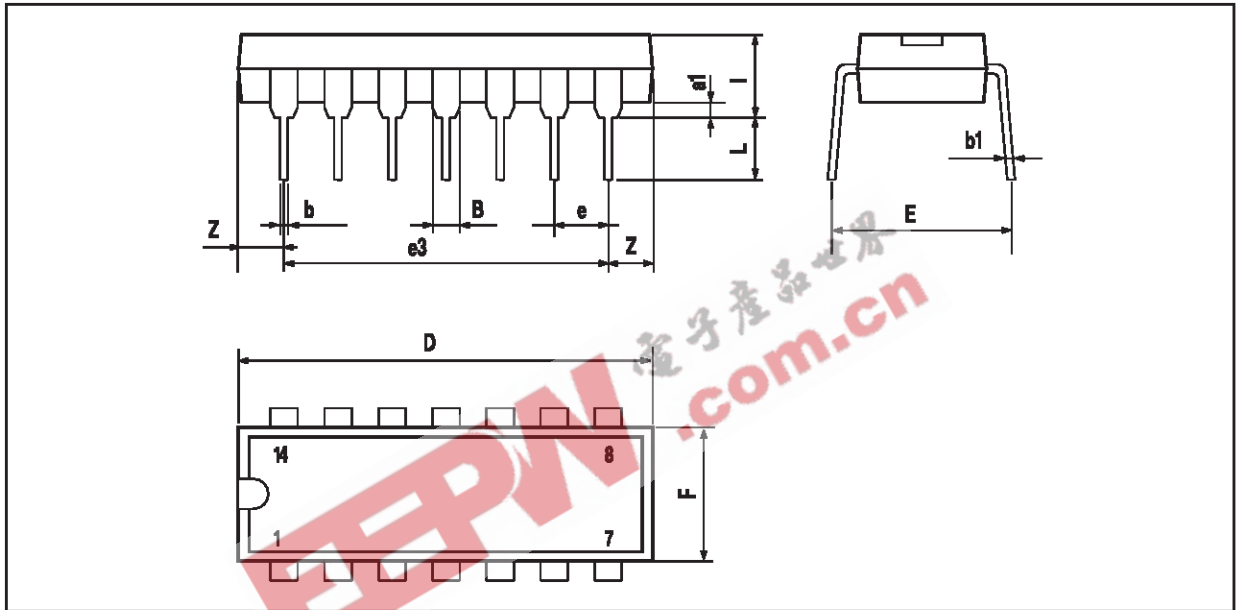

Dim.	Millimeters			Inches		
	Min.	Typ.	Max.	Min.	Typ.	Max.
a1	0.51			0.020		
B	1.39		1.65	0.055		0.065
b		0.5			0.020	
b1		0.25			0.010	
D			20			0.787
E		8.5			0.335	
e		2.54			0.100	
e3		15.24			0.600	
F			7.1			0.280
i			5.1			0.201
L		3.3			0.130	
Z	1.27		2.54	0.050		0.100

TS944ID

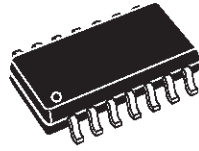

**PACKAGE MECHANICAL DATA**  
14 PINS - PLASTIC MICROPACKAGE (SO)

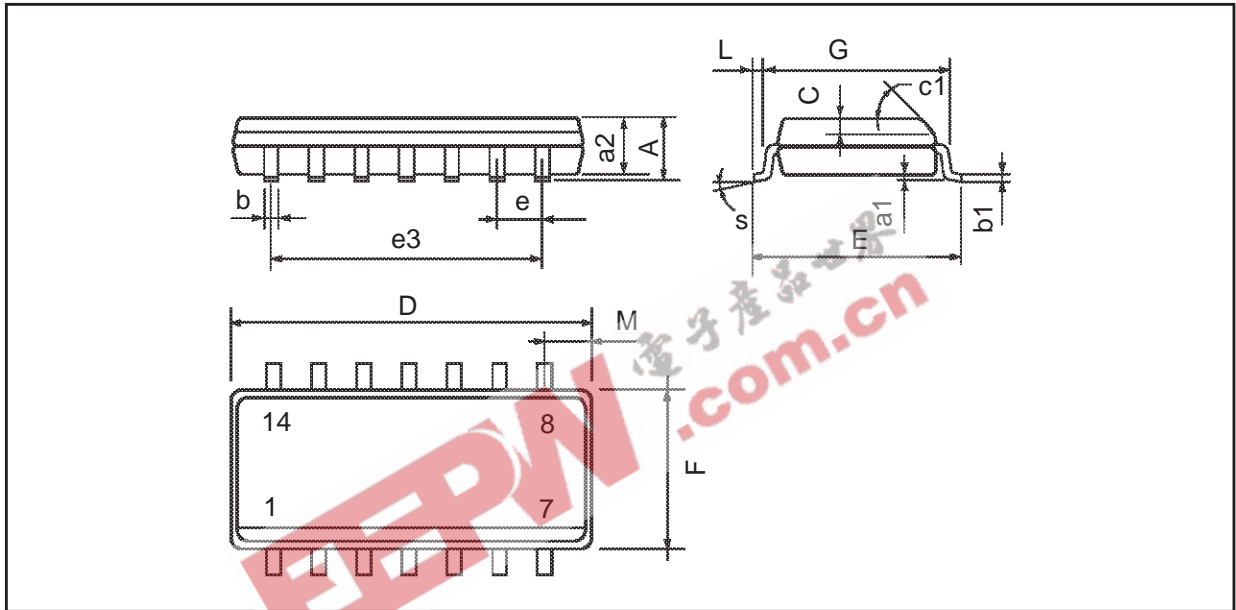

Dim.	Millimeters			Inches		
	Min.	Typ.	Max.	Min.	Typ.	Max.
A			1.75			0.069
a1	0.1		0.2	0.004		0.008
a2			1.6			0.063
b	0.35		0.46	0.014		0.018
b1	0.19		0.25	0.007		0.010
C		0.5			0.020	
c1	45° (typ.)					
D (1)	8.55		8.75	0.336		0.344
E	5.8		6.2	0.228		0.244
e		1.27			0.050	
e3		7.62			0.300	
F (1)	3.8		4.0	0.150		0.157
G	4.6		5.3	0.181		0.208
L	0.5		1.27	0.020		0.050
M			0.68			0.027
S	8° (max.)					

Note : (1) D and F do not include mold flash or protrusions - Mold flash or protrusions shall not exceed 0.15mm (.066 inc) ONLY FOR DATA BOOK.

# TS941-TS942-TS944

## TS944IPT

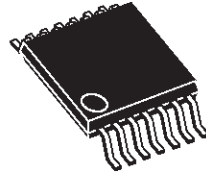

### PACKAGE MECHANICAL DATA

14 PINS - THIN SHRINK SMALL OUTLINE PACKAGE

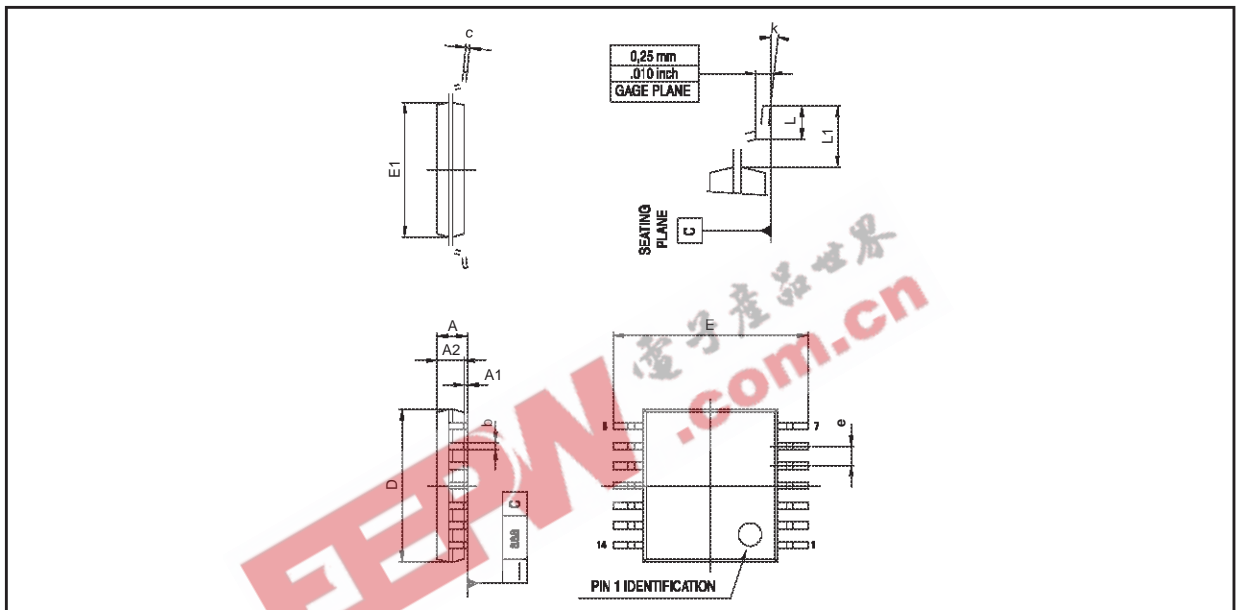

Dim.	Millimeters			Inches		
	Min.	Typ.	Max.	Min.	Typ.	Max.
A			1.20			0.05
A1	0.05		0.15	0.01		0.006
A2	0.80	1.00	1.05	0.031	0.039	0.041
b	0.19		0.30	0.007		0.15
c	0.09		0.20	0.003		0.012
D	4.90	5.00	5.10	0.192	0.196	0.20
E		6.40			0.252	
E1	4.30	4.40	4.50	0.169	0.173	0.177
e		0.65			0.025	
k	0°		8°	0°		8°
l	0.50	0.60	0.75	0.09	0.0236	0.030

# TS941-TS942-TS944

## TS941ILT

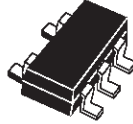

### PACKAGE MECHANICAL DATA 5 PINS - TINY PACKAGE (SOT23)

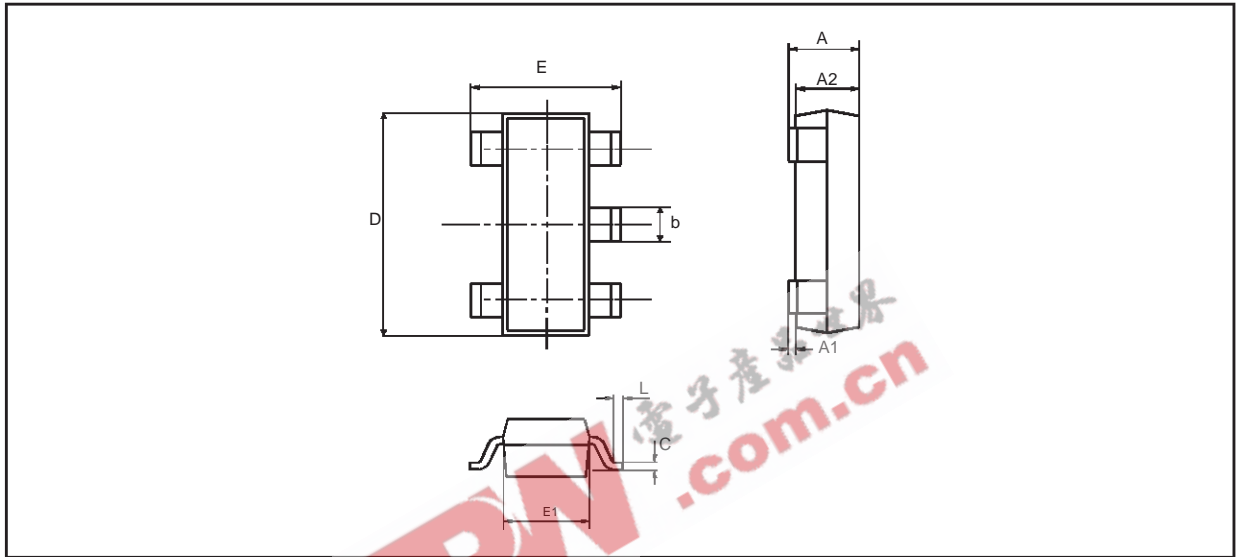

Dim.	Millimeters			Inches		
	Min.	Typ.	Max.	Min.	Typ.	Max.
A	0.90	1.20	1.45	0.035	0.047	0.057
A1	0		0.15			0.006
A2	0.90	1.05	1.30	0.035	0.041	0.051
B	0.35	0.40	0.50	0.014	0.016	0.020
C	0.09	0.15	0.20	0.004	0.006	0.008
D	2.80	2.90	3.00	0.110	0.114	0.118
D1		1.90			0.075	
e		0.95			0.037	
E	2.60	2.80	3.00	0.102	0.110	0.0118
F	1.50	1.60	1.75	0.059	0.063	0.069
L	0.10	0.5	0.60	0.004	0.014	0.024
K	0d		10d	0d		10d

Information furnished is believed to be accurate and reliable. However, STMicroelectronics assumes no responsibility for the consequences of use of such information nor for any infringement of patents or other rights of third parties which may result from its use. No license is granted by implication or otherwise under any patent or patent rights of STMicroelectronics. Specifications mentioned in this publication are subject to change without notice. This publication supersedes and replaces all information previously supplied. STMicroelectronics products are not authorized for use as critical components in life support devices or systems without express written approval of STMicroelectronics.

© The ST logo is a registered trademark of STMicroelectronics

© 2000 STMicroelectronics - Printed in Italy - All Rights Reserved  
STMicroelectronics GROUP OF COMPANIES

Australia - Brazil - China - Finland - France - Germany - Hong Kong - India - Italy - Japan - Malaysia - Malta - Morocco  
Singapore - Spain - Sweden - Switzerland - United Kingdom

© <http://www.st.com>