

## HIGH SPEED CMOS QUAD OPERATIONAL AMPLIFIERS

- OUTPUT VOLTAGE CAN SWING TO GROUND
- EXCELLENT PHASE MARGIN ON CAPACITIVE LOADS
- GAIN BANDWIDTH PRODUCT : 3.5MHz
- STABLE AND LOW OFFSET VOLTAGE
- THREE INPUT OFFSET VOLTAGE SELECTIONS

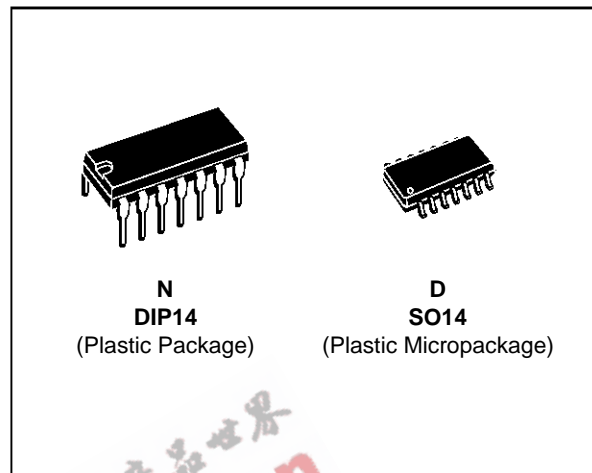

### ORDER CODES

| Part Number  | Temperature Range | Package |   |
|--------------|-------------------|---------|---|
|              |                   | N       | D |
| TS274C/AC/BC | 0°C, +70°C        | ●       | ● |
| TS274I/AI/BI | -40°C, +125°C     | ●       | ● |
| TS274M/AM/BM | -55°C, +125°C     | ●       | ● |

**Example :** TS274ACN

### DESCRIPTION

The TS274 series are low cost, low power quad operational amplifiers designed to operate with single or dual supplies. These operational amplifiers use the SGS-THOMSON silicon gate CMOS process allowing an excellent consumption-speed ratio. These series are ideally suited for low consumption applications.

Three power consumptions are available allowing to have always the best consumption-speed ratio :

- $I_{CC} = 10\mu\text{A}/\text{amp.}$  : TS27L4 (very low power)
- $I_{CC} = 150\mu\text{A}/\text{amp.}$  : TS27M4 (low power)
- $I_{CC} = 1\text{mA}/\text{amp.}$  : TS274 (high speed)

These CMOS amplifiers offer very high input impedance and extremely low input currents. The major advantage versus JFET devices is the very low input currents drift with temperature (see figure 2).

### PIN CONNECTIONS (top view)

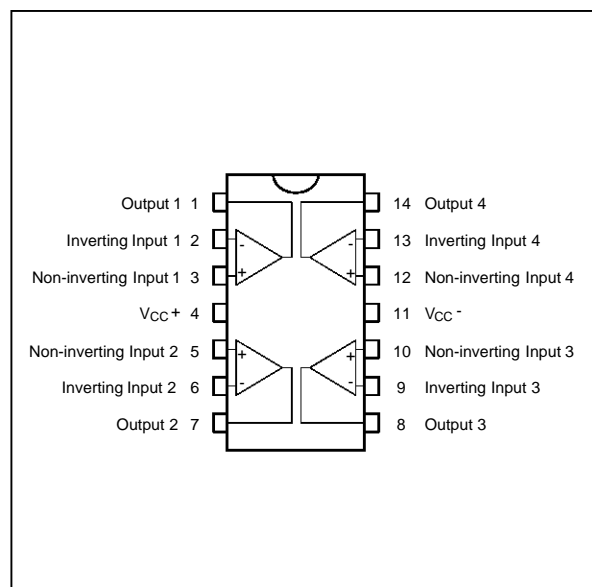

**BLOCK DIAGRAM**

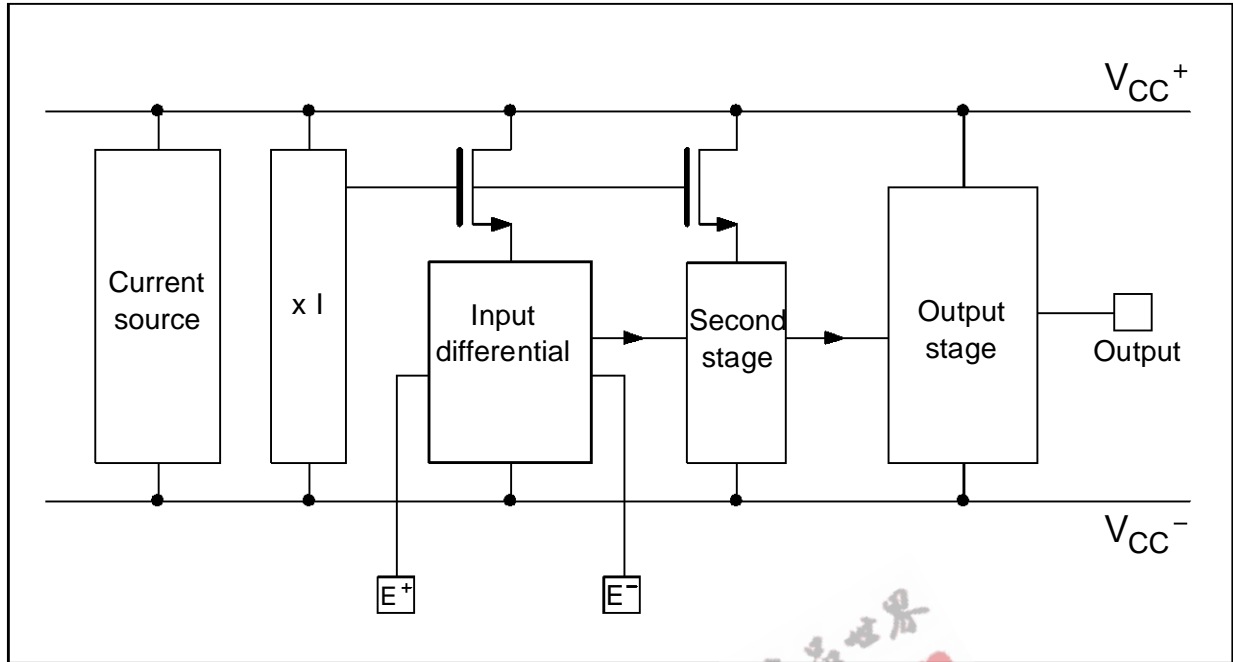

**MAXIMUM RATINGS**

| Symbol     | Parameter                              | Value  | Unit        |
|------------|--|--|-------------|
| $V_{CC}^+$ | Supply Voltage - (note 1)              | 18   | V           |
| $V_{id}$   | Differential Input Voltage - (note 2)  | $\pm 18$                                     | V           |
| $V_i$      | Input Voltage - (note 3)               | -0.3 to 18                                   | V           |
| $I_O$      | Output Current for $V_{CC}^+ \geq 15V$ | $\pm 30$                                     | mA          |
| $I_{in}$   | Input Current                          | $\pm 5$                                      | mA          |
| $T_{oper}$ | Operating Free-Air Temperature Range   | TS274C/AC/BC<br>TS274I/AI/BI<br>TS274M/AM/BM | $^{\circ}C$ |
| $T_{stg}$  | Storage Temperature Range              | -65 to +150                                  | $^{\circ}C$ |

**Notes :** 1. All voltage values, except differential voltage, are with respect to network ground terminal.  
 2. Differential voltages are at the non-inverting input terminal with respect to the inverting input terminal.  
 3. The magnitude of the input and the output voltages must never exceed the magnitude of the positive supply voltage.

**OPERATING CONDITIONS**

| Symbol     | Parameter                       | Value                 | Unit |
|------------|---------------------------------|-----------------------|------|
| $V_{CC}^+$ | Supply Voltage                  | 3 to 16               | V    |
| $V_{icm}$  | Common Mode Input Voltage Range | 0 to $V_{CC}^+ - 1.5$ | V    |

**SCHEMATIC DIAGRAM** (for 1/4 TS274)

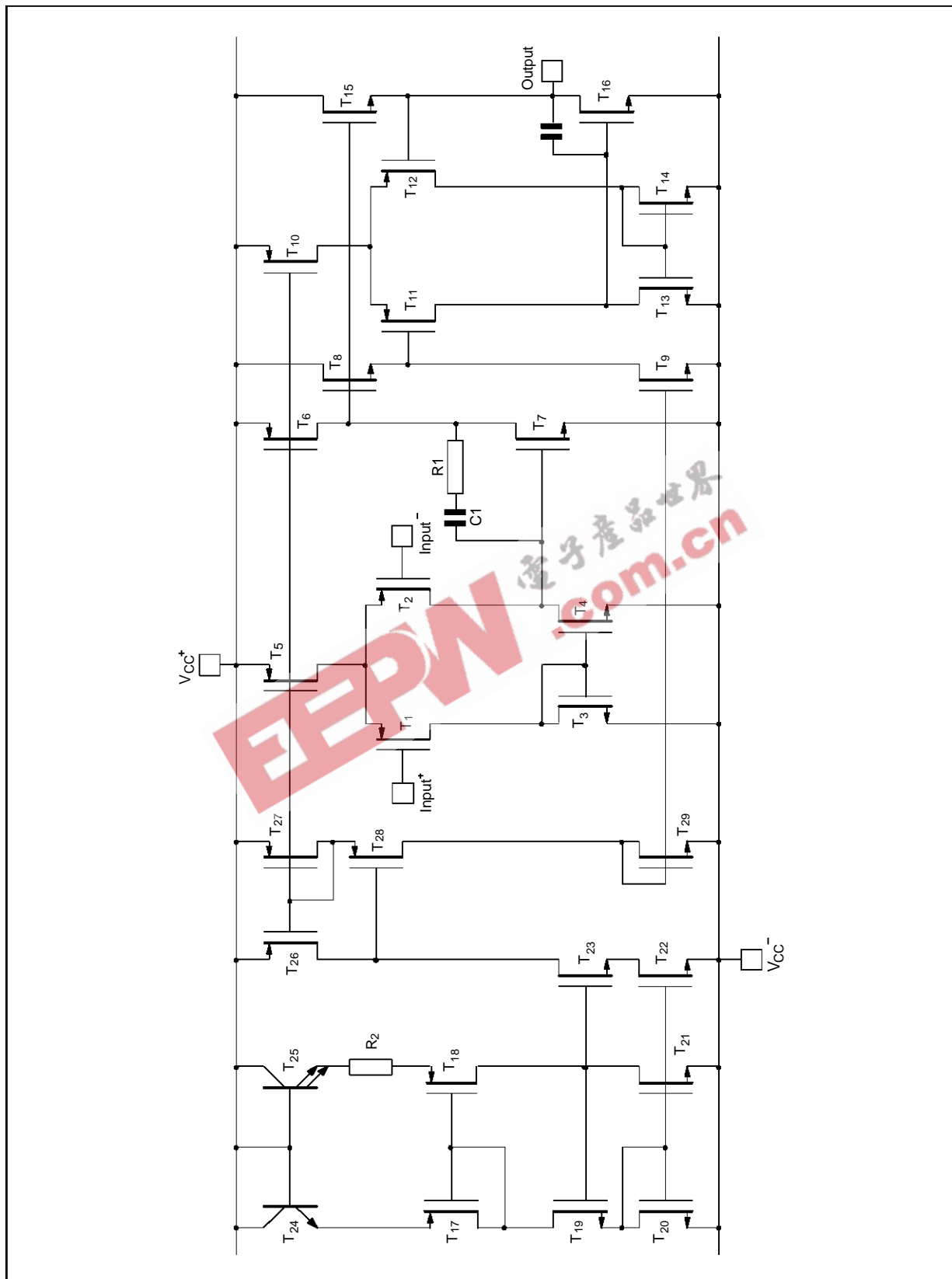

# TS274C,I,M

## ELECTRICAL CHARACTERISTICS

$V_{CC}^+ = +10V$ ,  $V_{CC}^- = 0V$ ,  $T_{amb} = 25^{\circ}C$  (unless otherwise specified)

| Symbol          | Parameter   | TS274C/AC/BC |                    |                                | TS274I/AI/BI<br>TS274M/AM/BM |                    |                                  | Unit                   |
|-----------------|---|--------------|--------------------|--------------------------------|------------------------------|--------------------|----------------------------------|------------------------|
|                 |   | Min.         | Typ.               | Max.                           | Min.                         | Typ.               | Max.                             |                        |
| $V_{io}$        | Input Offset Voltage<br>$V_O = 1.4V$ , $V_{ic} = 0V$<br>TS274C/I/M<br>TS274AC/AI/AM<br>TS274BC/BI/BM<br>$T_{min.} \leq T_{amb} \leq T_{max.}$<br>TS274C/I/M<br>TS274AC/AI/AM<br>TS274BC/BI/BM |              | 1.1<br>0.9<br>0.25 | 10<br>5<br>2<br>12<br>6.5<br>3 |                              | 1.1<br>0.9<br>0.25 | 10<br>5<br>2<br>12<br>6.5<br>3.5 | mV                     |
| $DV_{io}$       | Input Offset Voltage Drift  |              | 2                  |                                |                              | 2                  |                                  | $\mu V/^{\circ}C$      |
| $I_{io}$        | Input Offset Current - (note 1)<br>$V_{ic} = 5V$ , $V_O = 5V$<br>$T_{min.} \leq T_{amb} \leq T_{max.}$  |              | 1                  | 100                            |                              | 1                  | 200                              | pA                     |
| $I_{ib}$        | Input Bias Current - (note 1)<br>$V_{ic} = 5V$ , $V_O = 5V$<br>$T_{min.} \leq T_{amb} \leq T_{max.}$  |              | 1                  | 150                            |                              | 1                  | 300                              | pA                     |
| $V_{OH}$        | High Level Output Voltage<br>$V_{id} = 100mV$ , $R_L = 10k\Omega$<br>$T_{min.} \leq T_{amb} \leq T_{max.}$  | 8.2<br>8.1   | 8.4                |                                | 8.2<br>8                     | 8.4                |                                  | V                      |
| $V_{OL}$        | High Level Output Voltage<br>$V_{id} = -100mV$  |              |                    | 50                             |                              |                    | 50                               | mV                     |
| $A_{vd}$        | Large Signal Voltage Gain<br>$V_O = 1V$ to $6V$ , $R_L = 10k\Omega$ , $V_{ic} = 5V$<br>$T_{min.} \leq T_{amb} \leq T_{max.}$  | 10<br>7      | 15                 |                                | 10<br>6                      | 15                 |                                  | V/mV                   |
| GBP             | Gain Bandwidth Product<br>$A_v = 40dB$ , $R_L = 10k\Omega$ , $C_L = 100pF$<br>$f_{in} = 100kHz$   |              | 3.5                |                                |                              | 3.5                |                                  | MHz                    |
| CMR             | Common Mode Rejection Ratio<br>$V_O = 1.4V$ , $V_{ic} = 1V$ to $7.4V$   | 65           | 80                 |                                | 65                           | 80                 |                                  | dB                     |
| SVR             | Supply Voltage Rejection Ratio<br>$V_{CC}^+ = 5V$ to $10V$ , $V_O = 1.4V$   | 60           | 70                 |                                | 60                           | 70                 |                                  | dB                     |
| $I_{CC}$        | Supply Current (per amplifier)<br>$A_v = 1$ , no load, $V_O = 5V$<br>$T_{min.} \leq T_{amb} \leq T_{max.}$  |              | 1000               | 1500<br>1600                   |                              | 1000               | 1500<br>1700                     | $\mu A$                |
| $I_o$           | Output Short Circuit Current<br>$V_{id} = 100mV$ , $V_O = 0V$   |              | 60                 |                                |                              | 60                 |                                  | mA                     |
| $I_{sink}$      | Output Sink Current<br>$V_{id} = -100mV$ , $V_O = V_{CC}$   |              | 45                 |                                |                              | 45                 |                                  | mA                     |
| SR              | Slew-Rate at Unity Gain<br>$R_L = 10k\Omega$ , $C_L = 100pF$ , $V_i = 3$ to $7V$  |              | 5.5                |                                |                              | 5.5                |                                  | $V/\mu s$              |
| $\phi_m$        | Phase Margin at Unity Gain<br>$A_v = 40dB$ , $R_L = 10k\Omega$ , $C_L = 100pF$  |              | 40                 |                                |                              | 40                 |                                  | Degrees                |
| $K_{OV}$        | Overshoot Factor  |              | 30                 |                                |                              | 30                 |                                  | %                      |
| $e_n$           | Equivalent Input Noise Voltage<br>$f = 1kHz$ , $R_s = 100\Omega$  |              | 30                 |                                |                              | 30                 |                                  | $\frac{nV}{\sqrt{Hz}}$ |
| $V_{O1}/V_{O2}$ | Channel Separation  |              | 120                |                                |                              | 120                |                                  | dB                     |

Note : 1. Maximum values including unavoidable inaccuracies of the industrial test.

TYPICAL CHARACTERISTICS

Figure 1 : Supply Current (each amplifier) versus Supply Voltage

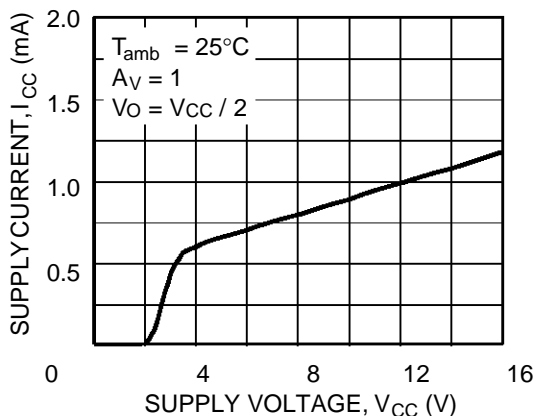

Figure 2 : Input Bias Current versus Free Air Temperature

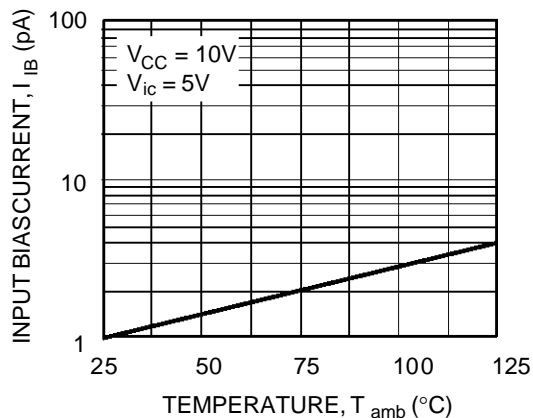

Figure 3a : High Level Output Voltage versus High Level Output Current

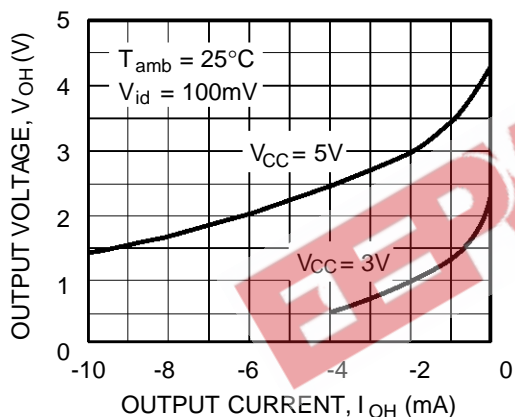

Figure 3b : High Level Output Voltage versus High Level Output Current

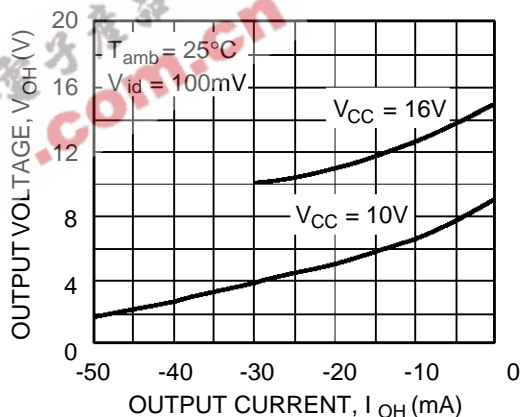

Figure 4a : High Level Output Voltage versus High Level Output Current

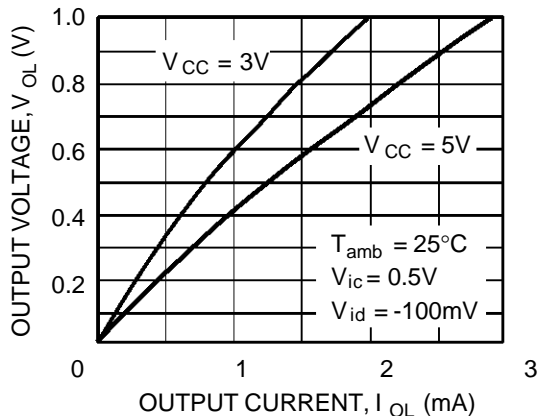
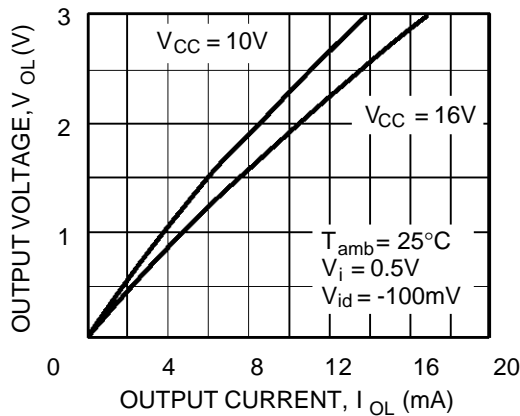

Figure 4b : High Level Output Voltage versus High Level Output Current



TYPICAL CHARACTERISTICS (continued)

Figure 5 : Open Loop Frequency Response and Phase Shift

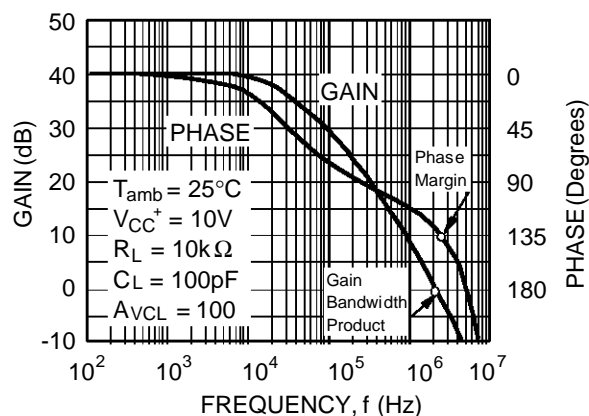

Figure 6 : Gain Bandwidth Product versus Supply Voltage

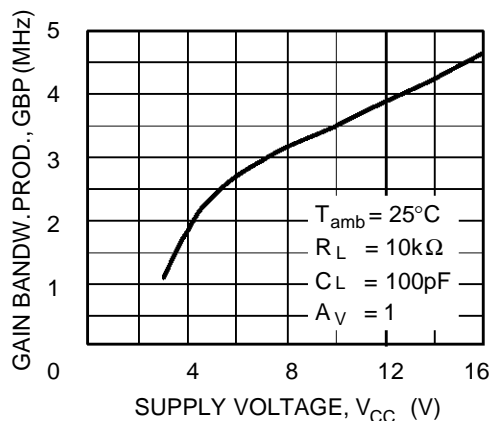

Figure 7 : Phase Margin versus Supply Voltage

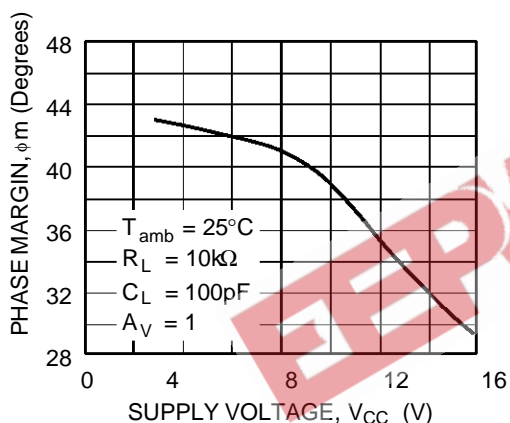

Figure 8 : Phase Margin versus Capacitive Load

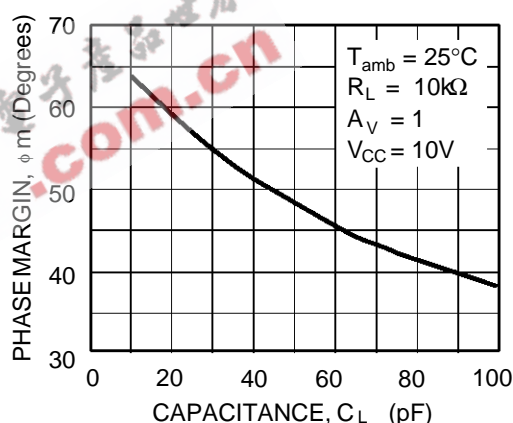

Figure 9 : Slew Rates versus Supply Voltage

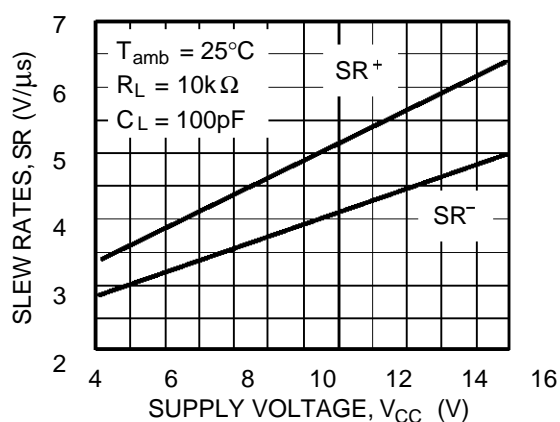
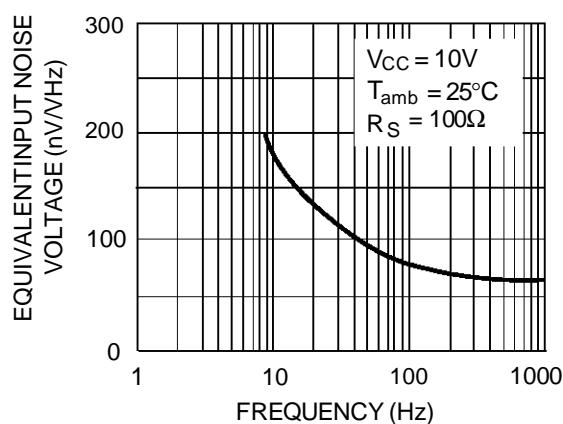
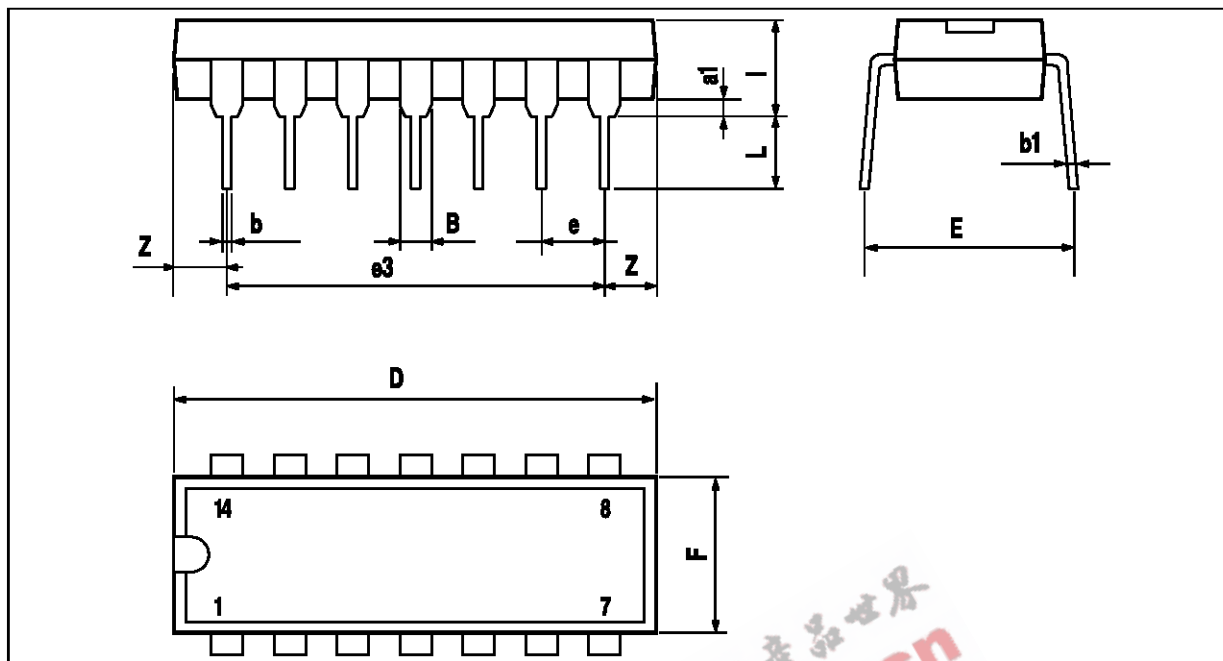

Figure 10 : Input Voltage Noise versus Frequency



**PACKAGE MECHANICAL DATA**  
14 PINS - PLASTIC DIP



PM-DIP14,EPS

| Dimensions | Millimeters |       |      | Inches |       |       |
|------------|-------------|-------|------|--------|-------|-------|
|            | Min.        | Typ.  | Max. | Min.   | Typ.  | Max.  |
| a1         | 0.51        |       |      | 0.020  |       |       |
| B          | 1.39        |       | 1.65 | 0.055  |       | 0.065 |
| b          |             | 0.5   |      |        | 0.020 |       |
| b1         |             | 0.25  |      |        | 0.010 |       |
| D          |             |       | 20   |        |       | 0.787 |
| E          |             | 8.5   |      |        | 0.335 |       |
| e          |             | 2.54  |      |        | 0.100 |       |
| e3         |             | 15.24 |      |        | 0.600 |       |
| F          |             |       | 7.1  |        |       | 0.280 |
| i          |             |       | 5.1  |        |       | 0.201 |
| L          |             | 3.3   |      |        | 0.130 |       |
| Z          | 1.27        |       | 2.54 | 0.050  |       | 0.100 |

DIP14,TBL

**TS274C,I,M**

**PACKAGE MECHANICAL DATA**  
 14 PINS - PLASTIC MICROPACKAGE (SO)

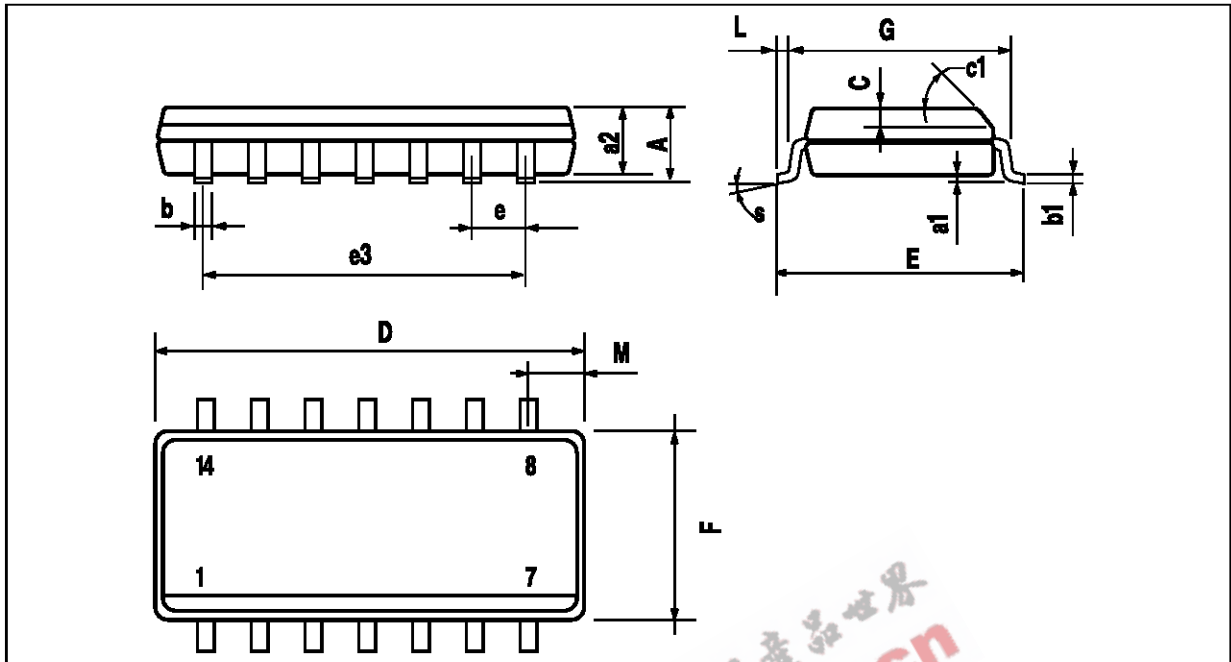

PM-SO14LEPS

| Dimensions | Millimeters |      |      | Inches |       |       |
|------------|-------------|------|------|--------|-------|-------|
|            | Min.        | Typ. | Max. | Min.   | Typ.  | Max.  |
| A          |             |      | 1.75 |        |       | 0.069 |
| a1         | 0.1         |      | 0.2  | 0.004  |       | 0.008 |
| a2         |             |      | 1.6  |        |       | 0.063 |
| b          | 0.35        |      | 0.46 | 0.014  |       | 0.018 |
| b1         | 0.19        |      | 0.25 | 0.007  |       | 0.010 |
| C          |             | 0.5  |      |        | 0.020 |       |
| c1         | 45° (typ.)  |      |      |        |       |       |
| D          | 8.55        |      | 8.75 | 0.336  |       | 0.334 |
| E          | 5.8         |      | 6.2  | 0.228  |       | 0.244 |
| e          |             | 1.27 |      |        | 0.050 |       |
| e3         |             | 7.62 |      |        | 0.300 |       |
| F          | 3.8         |      | 4.0  | 0.150  |       | 0.157 |
| G          | 4.6         |      | 5.3  | 0.181  |       | 0.208 |
| L          | 0.5         |      | 1.27 | 0.020  |       | 0.050 |
| M          |             |      | 0.68 |        |       | 0.027 |
| S          | 8° (max.)   |      |      |        |       |       |

SO14.TBL

Information furnished is believed to be accurate and reliable. However, SGS-THOMSON Microelectronics assumes no responsibility for the consequences of use of such information nor for any infringement of patents or other rights of third parties which may result from its use. No license is granted by implication or otherwise under any patent or patent rights of SGS-THOMSON Microelectronics. Specification mentioned in this publication are subject to change without notice. This publication supersedes and replaces all information previously supplied. SGS-THOMSON Microelectronics products are not authorized for use as critical components in life support devices or systems without express written approval of SGS-THOMSON Microelectronics.

© 1997 SGS-THOMSON Microelectronics – Printed in Italy – All Rights Reserved

SGS-THOMSON Microelectronics GROUP OF COMPANIES  
 Australia - Brazil - Canada - China - France - Germany - Hong Kong - Italy - Japan - Korea - Malaysia - Malta - Morocco  
 The Netherlands - Singapore - Spain - Sweden - Switzerland - Taiwan - Thailand - United Kingdom - U.S.A.

ORDER CODE :