

HIGH SPEED CMOS QUAD OPERATIONAL AMPLIFIERS

- OUTPUT VOLTAGE CAN SWING TO GROUND
- EXCELLENT PHASE MARGIN ON CAPACITIVE LOADS
- GAIN BANDWIDTH PRODUCT : 3.5MHz
- STABLE AND LOW OFFSET VOLTAGE
- THREE INPUT OFFSET VOLTAGE SELECTIONS

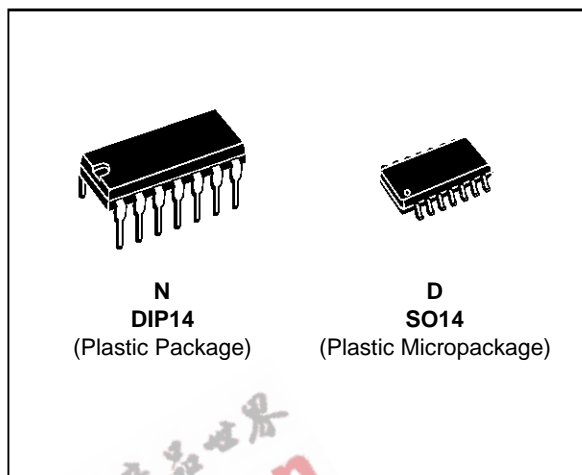

ORDER CODES

Part Number	Temperature Range	Package	
		N	D
TS274C/AC/BC	0°C, +70°C	●	●
TS274I/AI/BI	-40°C, +125°C	●	●
TS274M/AM/BM	-55°C, +125°C	●	●

Example : TS274ACN

DESCRIPTION

The TS274 series are low cost, low power quad operational amplifiers designed to operate with single or dual supplies. These operational amplifiers use the SGS-THOMSON silicon gate CMOS process allowing an excellent consumption-speed ratio. These series are ideally suited for low consumption applications.

Three power consumptions are available allowing to have always the best consumption-speed ratio :

- $I_{CC} = 10\mu\text{A}/\text{amp.}$: TS27L4 (very low power)
- $I_{CC} = 150\mu\text{A}/\text{amp.}$: TS27M4 (low power)
- $I_{CC} = 1\text{mA}/\text{amp.}$: TS274 (high speed)

These CMOS amplifiers offer very high input impedance and extremely low input currents. The major advantage versus JFET devices is the very low input currents drift with temperature (see figure 2).

PIN CONNECTIONS (top view)

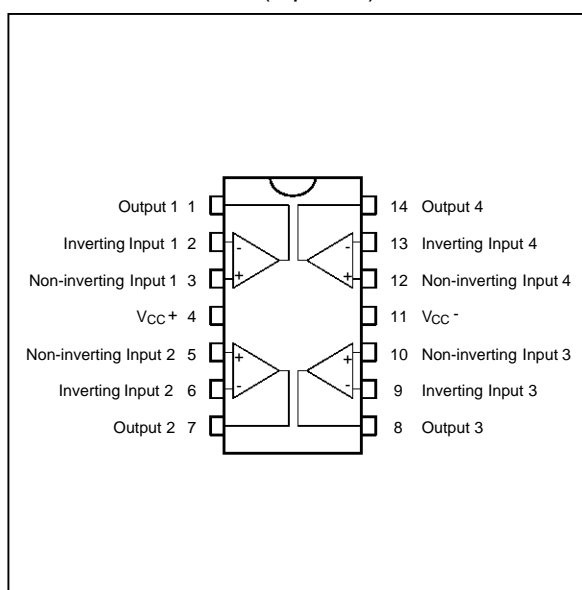

BLOCK DIAGRAM

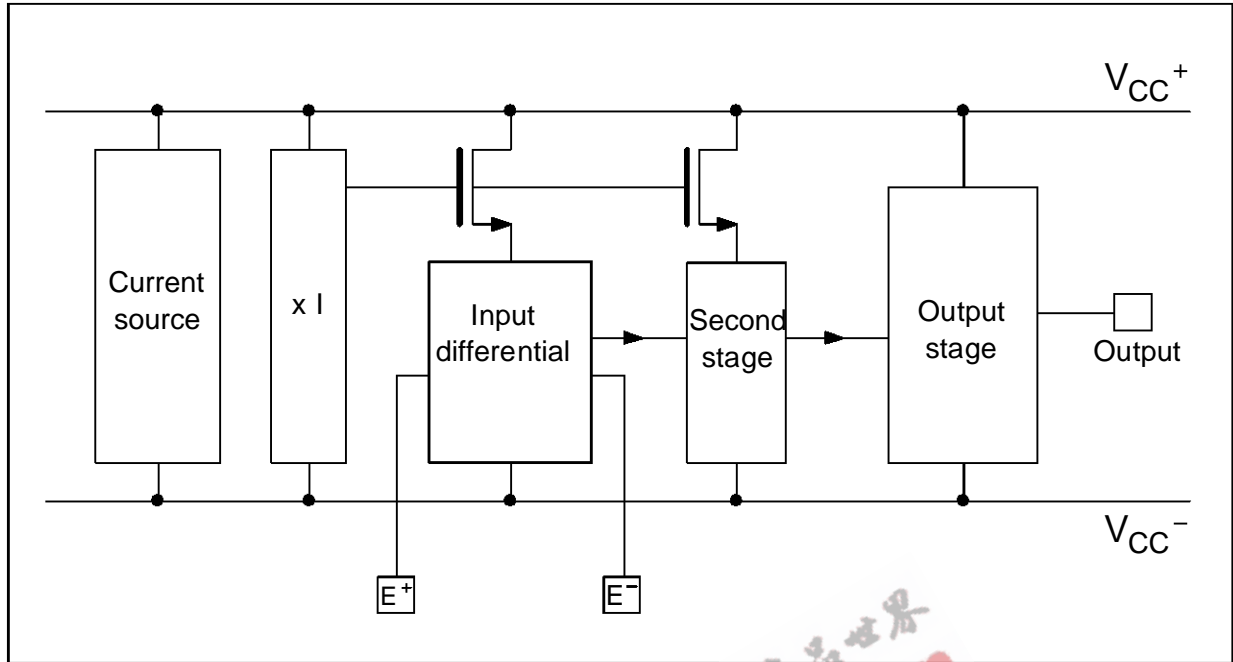

MAXIMUM RATINGS

Symbol	Parameter	Value	Unit	
V_{CC}^+	Supply Voltage - (note 1)	18	V	
V_{id}	Differential Input Voltage - (note 2)	± 18	V	
V_i	Input Voltage - (note 3)	-0.3 to 18	V	
I_O	Output Current for $V_{CC}^+ \geq 15V$	± 30	mA	
I_{in}	Input Current	± 5	mA	
T_{oper}	Operating Free-Air Temperature Range	TS274C/AC/BC TS274I/AI/BI TS274M/AM/BM	0 to $+70$ -40 to $+125$ -55 to $+125$	$^{\circ}C$
T_{stg}	Storage Temperature Range		-65 to +150	$^{\circ}C$

Notes : 1. All voltage values, except differential voltage, are with respect to network ground terminal.
 2. Differential voltages are at the non-inverting input terminal with respect to the inverting input terminal.
 3. The magnitude of the input and the output voltages must never exceed the magnitude of the positive supply voltage.

OPERATING CONDITIONS

Symbol	Parameter	Value	Unit
V_{CC}^+	Supply Voltage	3 to 16	V
V_{icm}	Common Mode Input Voltage Range	0 to $V_{CC}^+ - 1.5$	V

SCHEMATIC DIAGRAM (for 1/4 TS274)

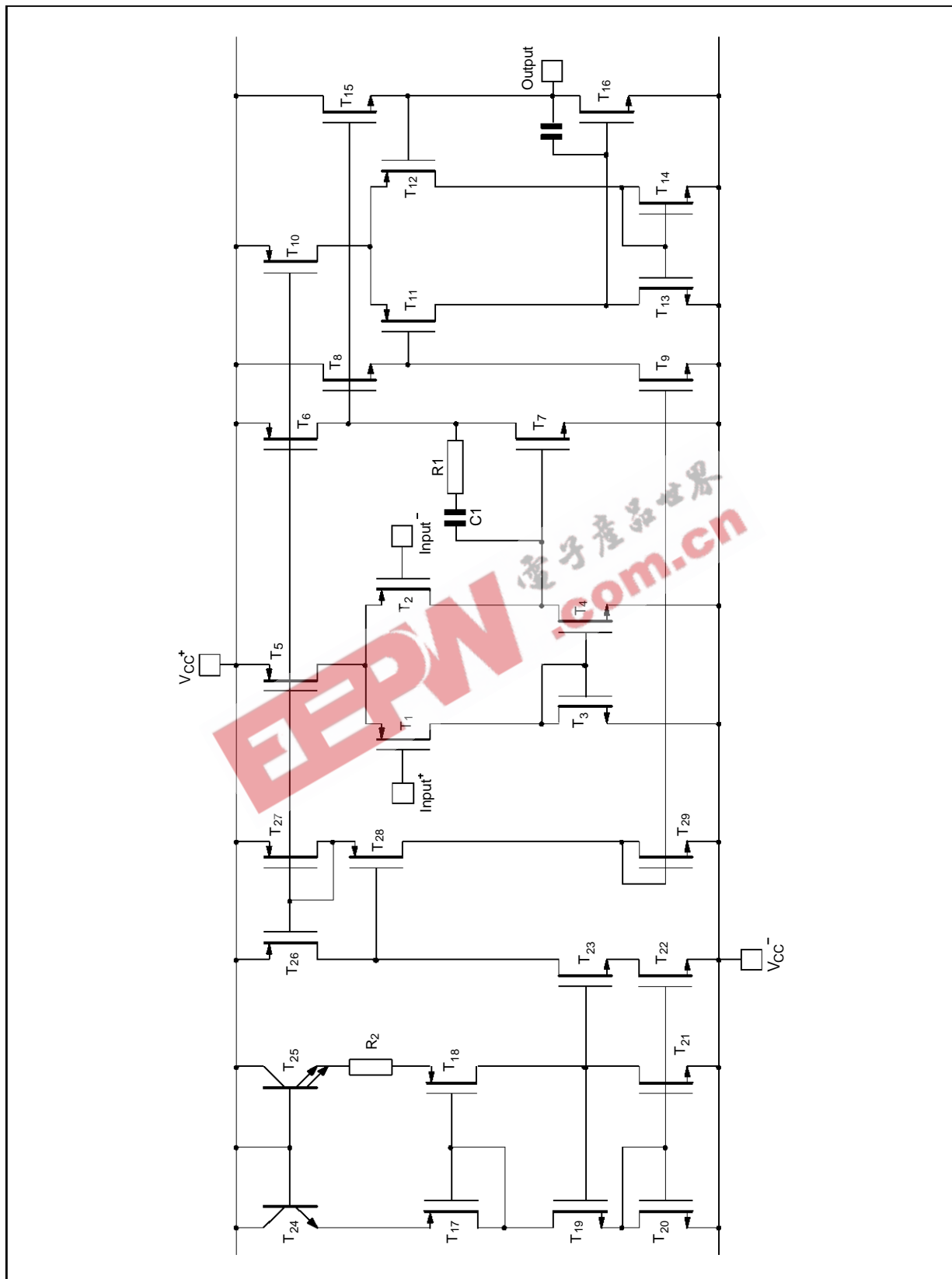

TS274C,I,M

ELECTRICAL CHARACTERISTICS

$V_{CC}^+ = +10V$, $V_{CC}^- = 0V$, $T_{amb} = 25^{\circ}C$ (unless otherwise specified)

Symbol	Parameter	TS274C/AC/BC			TS274I/AI/BI TS274M/AM/BM			Unit
		Min.	Typ.	Max.	Min.	Typ.	Max.	
V_{io}	Input Offset Voltage $V_O = 1.4V$, $V_{ic} = 0V$ TS274C/I/M TS274AC/AI/AM TS274BC/BI/BM $T_{min.} \leq T_{amb} \leq T_{max.}$ TS274C/I/M TS274AC/AI/AM TS274BC/BI/BM		1.1 0.9 0.25	10 5 2 12 6.5 3		1.1 0.9 0.25	10 5 2 12 6.5 3.5	mV
DV_{io}	Input Offset Voltage Drift		2			2		$\mu V/^{\circ}C$
I_{io}	Input Offset Current - (note 1) $V_{ic} = 5V$, $V_O = 5V$ $T_{min.} \leq T_{amb} \leq T_{max.}$		1	100		1	200	pA
I_{ib}	Input Bias Current - (note 1) $V_{ic} = 5V$, $V_O = 5V$ $T_{min.} \leq T_{amb} \leq T_{max.}$		1	150		1	300	pA
V_{OH}	High Level Output Voltage $V_{id} = 100mV$, $R_L = 10k\Omega$ $T_{min.} \leq T_{amb} \leq T_{max.}$	8.2 8.1	8.4		8.2 8	8.4		V
V_{OL}	High Level Output Voltage $V_{id} = -100mV$			50			50	mV
A_{vd}	Large Signal Voltage Gain $V_O = 1V$ to $6V$, $R_L = 10k\Omega$, $V_{ic} = 5V$ $T_{min.} \leq T_{amb} \leq T_{max.}$	10 7	15		10 6	15		V/mV
GBP	Gain Bandwidth Product $A_v = 40dB$, $R_L = 10k\Omega$, $C_L = 100pF$ $f_{in} = 100kHz$		3.5			3.5		MHz
CMR	Common Mode Rejection Ratio $V_O = 1.4V$, $V_{ic} = 1V$ to $7.4V$	65	80		65	80		dB
SVR	Supply Voltage Rejection Ratio $V_{CC}^+ = 5V$ to $10V$, $V_O = 1.4V$	60	70		60	70		dB
I_{CC}	Supply Current (per amplifier) $A_v = 1$, no load, $V_O = 5V$ $T_{min.} \leq T_{amb} \leq T_{max.}$		1000	1500 1600		1000	1500 1700	μA
I_o	Output Short Circuit Current $V_{id} = 100mV$, $V_O = 0V$		60			60		mA
I_{sink}	Output Sink Current $V_{id} = -100mV$, $V_O = V_{CC}$		45			45		mA
SR	Slew-Rate at Unity Gain $R_L = 10k\Omega$, $C_L = 100pF$, $V_i = 3$ to $7V$		5.5			5.5		V/ μs
ϕ_m	Phase Margin at Unity Gain $A_v = 40dB$, $R_L = 10k\Omega$, $C_L = 100pF$		40			40		Degrees
K_{OV}	Overshoot Factor		30			30		%
e_n	Equivalent Input Noise Voltage $f = 1kHz$, $R_S = 100\Omega$		30			30		$\frac{nV}{\sqrt{Hz}}$
V_{O1}/V_{O2}	Channel Separation		120			120		dB

Note : 1. Maximum values including unavoidable inaccuracies of the industrial test.

TYPICAL CHARACTERISTICS

Figure 1 : Supply Current (each amplifier) versus Supply Voltage

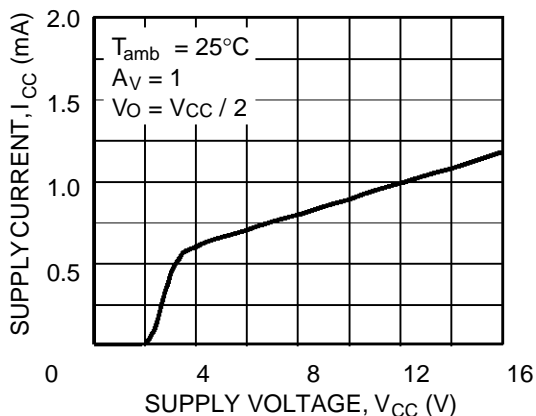

Figure 2 : Input Bias Current versus Free Air Temperature

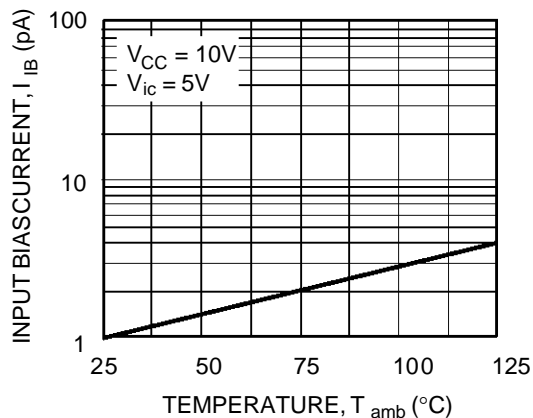

Figure 3a : High Level Output Voltage versus High Level Output Current

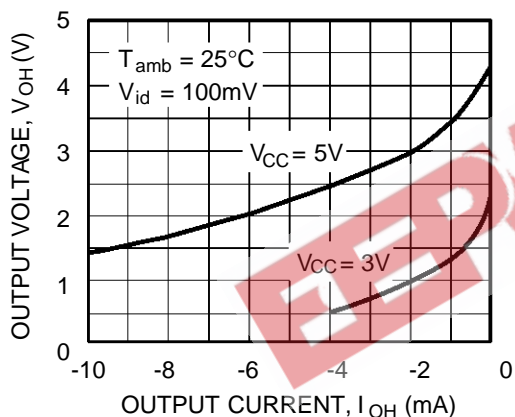

Figure 3b : High Level Output Voltage versus High Level Output Current

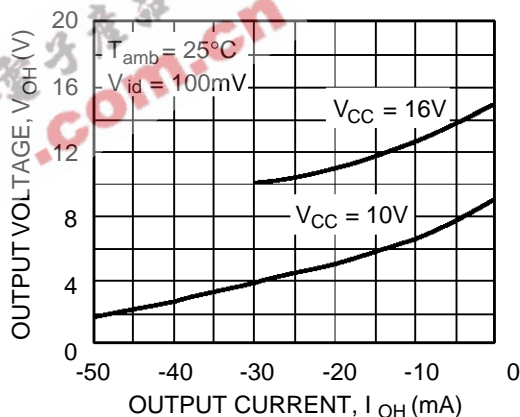

Figure 4a : High Level Output Voltage versus High Level Output Current

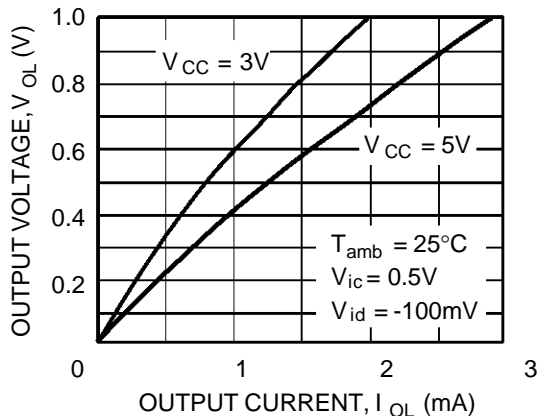
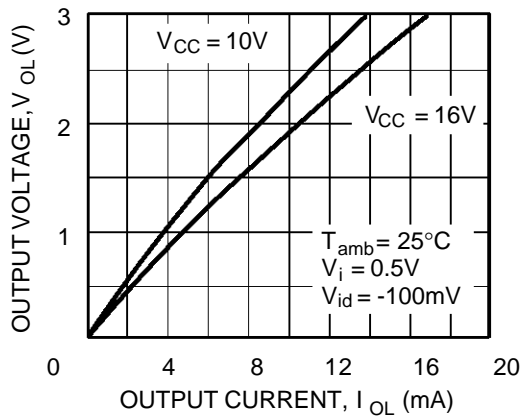

Figure 4b : High Level Output Voltage versus High Level Output Current



TYPICAL CHARACTERISTICS (continued)

Figure 5 : Open Loop Frequency Response and Phase Shift

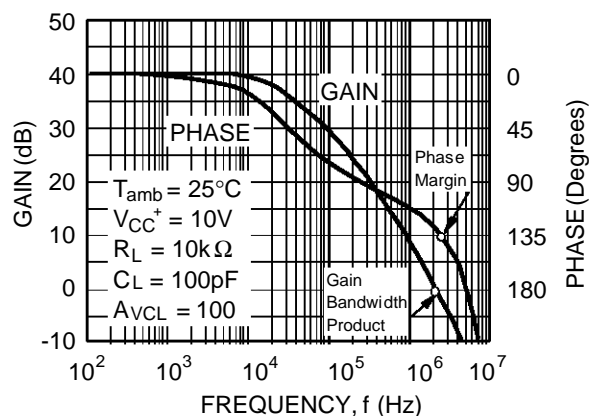

Figure 6 : Gain Bandwidth Product versus Supply Voltage

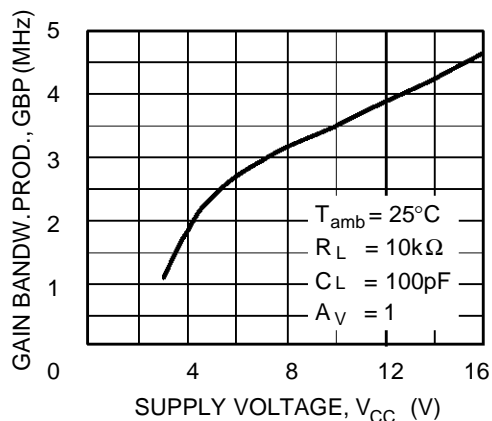

Figure 7 : Phase Margin versus Supply Voltage

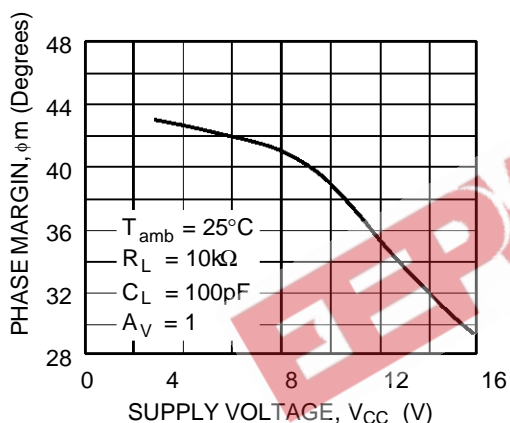

Figure 8 : Phase Margin versus Capacitive Load

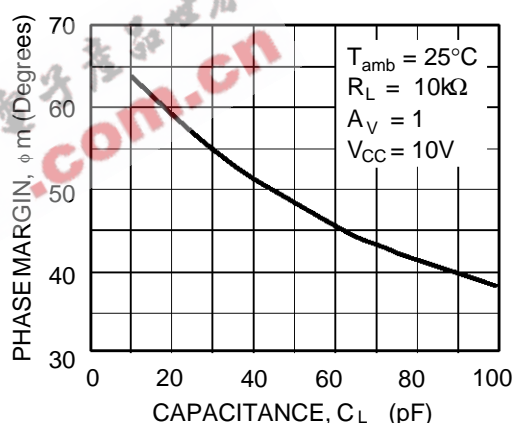

Figure 9 : Slew Rates versus Supply Voltage

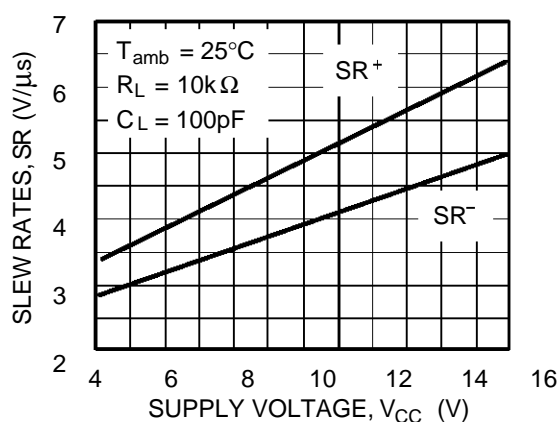
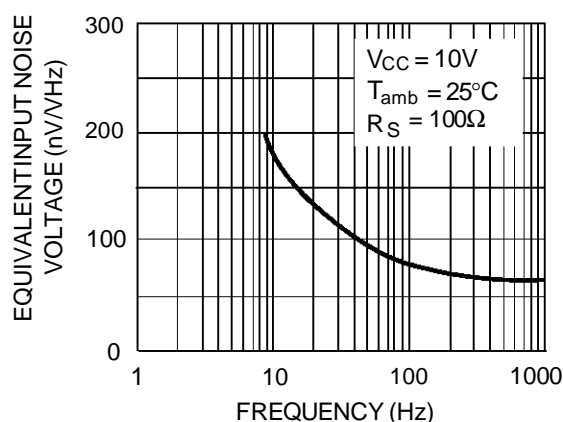
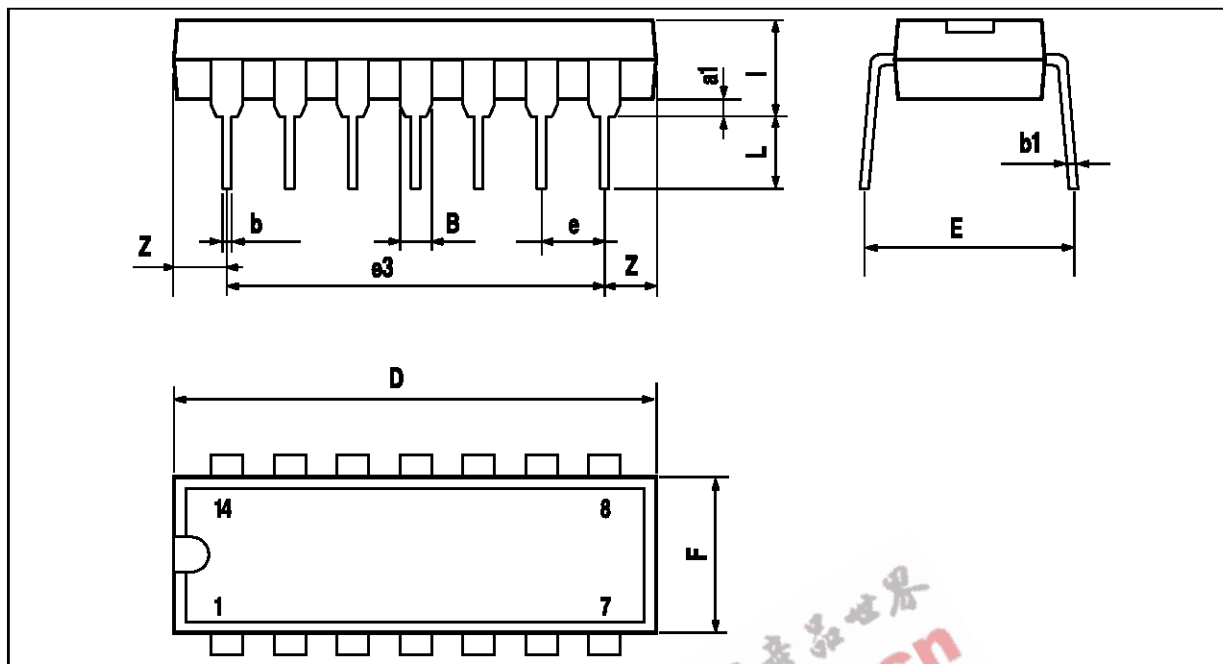

Figure 10 : Input Voltage Noise versus Frequency



PACKAGE MECHANICAL DATA
14 PINS - PLASTIC DIP



PM-DIP14,EPS

Dimensions	Millimeters			Inches		
	Min.	Typ.	Max.	Min.	Typ.	Max.
a1	0.51			0.020		
B	1.39		1.65	0.055		0.065
b		0.5			0.020	
b1		0.25			0.010	
D			20			0.787
E		8.5			0.335	
e		2.54			0.100	
e3		15.24			0.600	
F			7.1			0.280
i			5.1			0.201
L		3.3			0.130	
Z	1.27		2.54	0.050		0.100

DIP14,TBL

TS274C,I,M

PACKAGE MECHANICAL DATA
 14 PINS - PLASTIC MICROPACKAGE (SO)

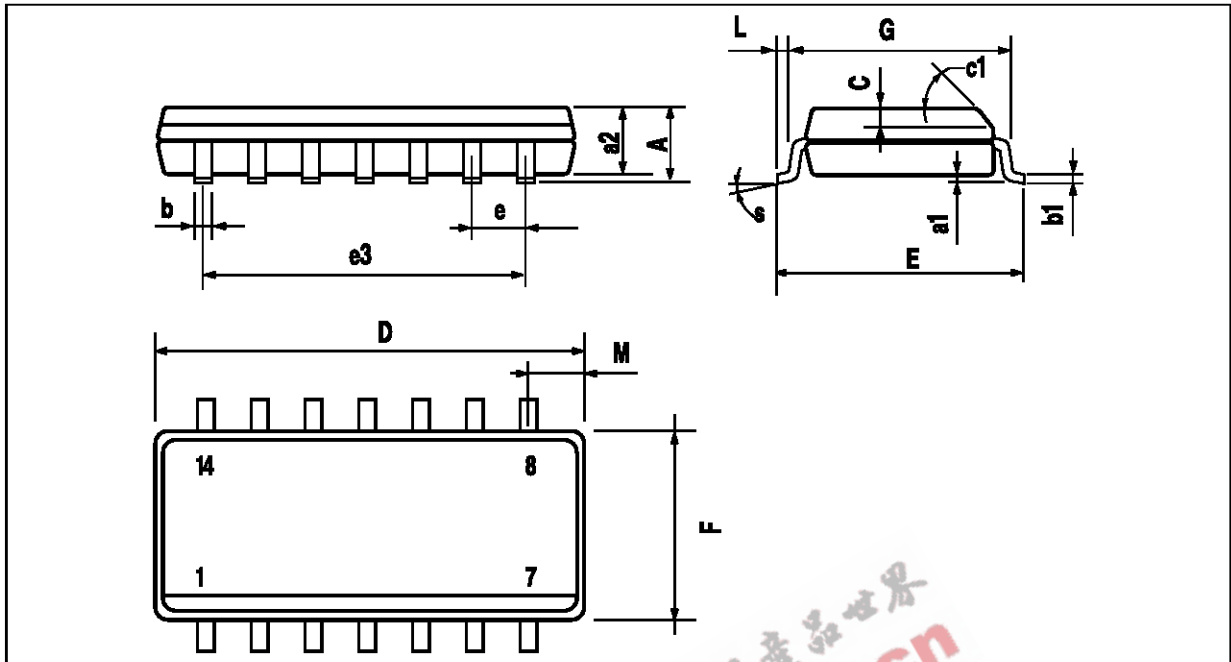

PM-SO14LEPS

Dimensions	Millimeters			Inches		
	Min.	Typ.	Max.	Min.	Typ.	Max.
A			1.75			0.069
a1	0.1		0.2	0.004		0.008
a2			1.6			0.063
b	0.35		0.46	0.014		0.018
b1	0.19		0.25	0.007		0.010
C		0.5			0.020	
c1	45° (typ.)					
D	8.55		8.75	0.336		0.334
E	5.8		6.2	0.228		0.244
e		1.27			0.050	
e3		7.62			0.300	
F	3.8		4.0	0.150		0.157
G	4.6		5.3	0.181		0.208
L	0.5		1.27	0.020		0.050
M			0.68			0.027
S	8° (max.)					

SO14.TBL

Information furnished is believed to be accurate and reliable. However, SGS-THOMSON Microelectronics assumes no responsibility for the consequences of use of such information nor for any infringement of patents or other rights of third parties which may result from its use. No license is granted by implication or otherwise under any patent or patent rights of SGS-THOMSON Microelectronics. Specification mentioned in this publication are subject to change without notice. This publication supersedes and replaces all information previously supplied. SGS-THOMSON Microelectronics products are not authorized for use as critical components in life support devices or systems without express written approval of SGS-THOMSON Microelectronics.

© 1997 SGS-THOMSON Microelectronics – Printed in Italy – All Rights Reserved

SGS-THOMSON Microelectronics GROUP OF COMPANIES
 Australia - Brazil - Canada - China - France - Germany - Hong Kong - Italy - Japan - Korea - Malaysia - Malta - Morocco
 The Netherlands - Singapore - Spain - Sweden - Switzerland - Taiwan - Thailand - United Kingdom - U.S.A.

ORDER CODE :