



**TS931
TS932
TS934**

OUTPUT RAIL TO RAIL MICROPOWER OPERATIONAL AMPLIFIERS

- RAIL TO RAIL **OUTPUT VOLTAGE SWING**
- **MICROPOWER CONSUMPTION (20µA)**
- **SINGLE SUPPLY OPERATION (2.7V to 10V)**
- **LOW OFFSET (2mV max for TS93xB)**
- **CMOS INPUTS**
- **ULTRA LOW INPUT BIAS CURRENT (1pA)**
- **ESD PROTECTION (2kV)**
- **LATCH-UP IMMUNITY (Class A)**
- **AVAILABLE IN SOT23-5 MICROPACKAGE**

DESCRIPTION

The TS93x (Single, Dual & Quad) is Operational Amplifier able to operate with voltage as low as 2.7V and to reach 2.9Vpp of output swing with $R_L = 100k\Omega$ when supplied @ 3V. Offering a typical consumption of only 20µA, it is particularly well-suited for every kind of battery-supplied applications.

The TS93x is housed in the space-saving 5 pins SOT23-5 package which simplifies the board design because of the ability to be placed everywhere (outside dimensions are : 2.8mm x 2.9mm).

APPLICATION

- Battery-powered systems
- Portable communication systems
- Alarm, smoke detectors
- Instrumentation & sensing
- PH Meter
- Digital scales

ORDER CODE

Part Number	Temperature Range	Package				SOT23 Marking
		N	D	P	L	
TS931I TS931A/BI	-40, +85°C		•		•	K205 K206/207
TS932I TS932A/BI	-40, +85°C	•	•			
TS934I TS934A/BI	-40, +85°C	•	•	•		

N = Dual in Line Package (DIP)
D = Small Outline Package (SO) - also available in Tape & Reel (DT)
P = Thin Shrink Small Outline Package (TSSOP) - only available in Tape & Reel (PT)
L = Tiny Package (SOT23-5) - only available in Tape & Reel (LT)

PIN CONNECTIONS (top view)

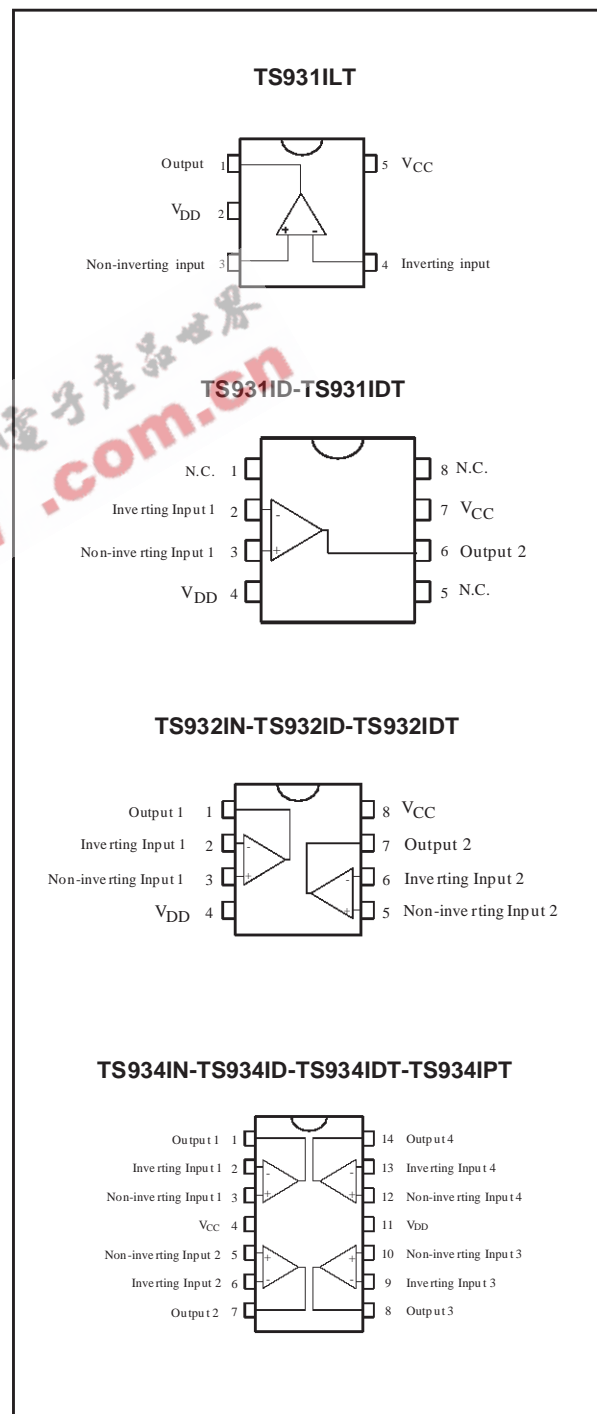

ABSOLUTE MAXIMUM RATINGS

Symbol	Parameter	Value	Unit
V_{CC}	Supply voltage ¹⁾	12	V
V_{id}	Differential Input Voltage ²⁾	± 12	V
V_{in}	Input Voltage Range ³⁾	-0.3 to 12.3	V
T_{oper}	Operating Free Air Temperature Range	-40 to + 85	°C
T_{std}	Storage Temperature Range	-65 to +150	°C
T_j	Maximum Junction Temperature	150	°C
R_{thjc}	Thermal Resistance Junction to Case ⁴⁾		°C/W
	SOT23-5	81	
	DIP8	42	
	DIP14	32	
	SO8	28	
	SO14	22	
	TSSOP8	26	
	TSSOP14	21	
R_{thja}	Thermal Resistance Junction to Ambient - SOT23-5	256	°C/W
ESD	Human Body Model	2	kV
	Latch-up Immunity	Class A	
	Lead Temperature (soldering, 10sec)	260	°C

1. All voltages values, except differential voltage are with respect to network terminal.

2. Differential voltages are non-inverting input terminal with respect to the inverting input terminal.

3. The magnitude of input and output voltages must never exceed $V_{CC} + 0.3V$.

4. Short-circuits can cause excessive heating and destructive dissipation.

OPERATING CONDITIONS

Symbol	Parameter	Value	Unit
V_{CC}	Supply Voltage	2.7 to 10	V
V_{icm}	Common Mode Input Voltage Range	$V_{ee} - 0.2$ to $V_{CC} - 1.5$	V

TS931-TS932-TS934

ELECTRICAL CHARACTERISTICS

$V_{CC} = +3V$, $V_{EE} = 0V$,

$T_{amb} = 25^{\circ}C$ (unless otherwise specified)

Symbol	Parameter	Min.	Typ.	Max.	Unit
V_{io}	Input Offset Voltage TS931/2/4 TS931/2/4A TS931/2/4B			10 5 2	mV
ΔV_{io}	Input Offset Voltage Drift		3		$\mu V/^{\circ}C$
I_{io}	Input Offset Current ¹⁾		1	100	pA
I_{ib}	Input Bias Current ¹⁾		1	150	pA
CMR	Common Mode Rejection Ratio $0 \leq V_{icm} \leq V_{CC} - 1.7$		85		dB
SVR	Supply Voltage Rejection Ratio ²⁾		85		dB
A_{vd}	Large Signal Voltage Gain $V_O = 2V_{pp}$ $R_L = 1M\Omega$ $R_L = 100k\Omega$		120 106		dB
V_{OH}	High Level Output Voltage $V_{ID} = 100mV$ $R_L = 100k\Omega$	2.95			V
V_{OL}	Low Level Output Voltage $V_{ID} = -100mV$ $R_L = 100k\Omega$			50	mV
I_o	Output Source Current $V_{ID} = 100mV$, $V_O = V_{DD}$ Output Sink Current $V_{ID} = -100mV$, $V_O = V_{CC}$		1.5 1.5		mA
I_{CC}	Supply Current (per amplifier) $A_{VCL} = 1$, no load		20	31	μA
GBP	Gain Bandwidth Product $R_L = 100k\Omega$, $C_L = 50pF$		100		kHz
SR	Slew Rate $R_L = 100k\Omega$, $C_L = 50pF$		50		V/ms
ϕ_m	Phase Margin $C_L = 50pF$		65		Degrees
en	Input Voltage Noise		75		nV/\sqrt{Hz}

1. Maximum values including unavoidable inaccuracies of the industrial test.

2. V_{CC} has a 0.2V variation.

ELECTRICAL CHARACTERISTICS $V_{CC} = +5V$, $V_{EE} = 0V$, $T_{amb} = 25^{\circ}C$ (unless otherwise specified)

Symbol	Parameter	Min.	Typ.	Max.	Unit
V_{io}	Input Offset Voltage TS931/2/4 TS931/2/4A TS931/2/4B			10 5 2	mV
ΔV_{io}	Input Offset Voltage Drift		3		$\mu V/^{\circ}C$
I_{io}	Input Offset Current ¹⁾		1	100	pA
I_{ib}	Input Bias Current ¹⁾		1	150	pA
CMR	Common Mode Rejection Ratio $0 \leq V_{icm} \leq V_{CC} - 1.7$		85		dB
SVR	Supply Voltage Rejection Ratio ²⁾		85		dB
A_{vd}	Large Signal Voltage Gain $V_O = 4V_{pp}$ $R_L = 1M\Omega$ $R_L = 100k\Omega$		120 112		dB
V_{OH}	High Level Output Voltage $V_{ID} = 100mV$ $R_L = 100k\Omega$	4.95			V
V_{OL}	Low Level Output Voltage $V_{ID} = -100mV$ $R_L = 100k\Omega$			50	mV
I_o	Output Source Current $V_{ID} = 100mV$, $V_O = V_{DD}$ Output Sink Current $V_{ID} = -100mV$, $V_O = V_{CC}$		5 5		mA
I_{CC}	Supply Current (per amplifier) $A_{VCL} = 1$, no load		20	33	μA
GBP	Gain Bandwidth Product $R_L = 100K\Omega$, $C_L = 50pF$		100		kHz
SR	Slew Rate $R_L = 100K\Omega$, $C_L = 50pF$		50		V/ms
ϕ_m	Phase Margin $C_L = 50pF$		65		Degrees
en	Input Voltage Noise		76		nV/\sqrt{Hz}

1. Maximum values including unavoidable inaccuracies of the industrial test.

2. V_{CC} has a 0.2V variation.

TS931-TS932-TS934

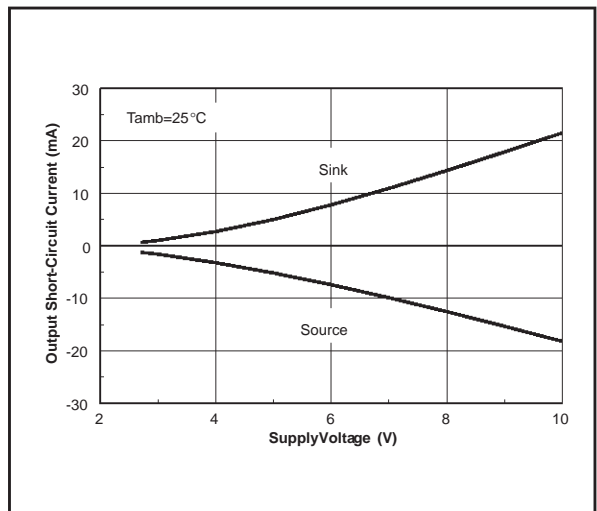
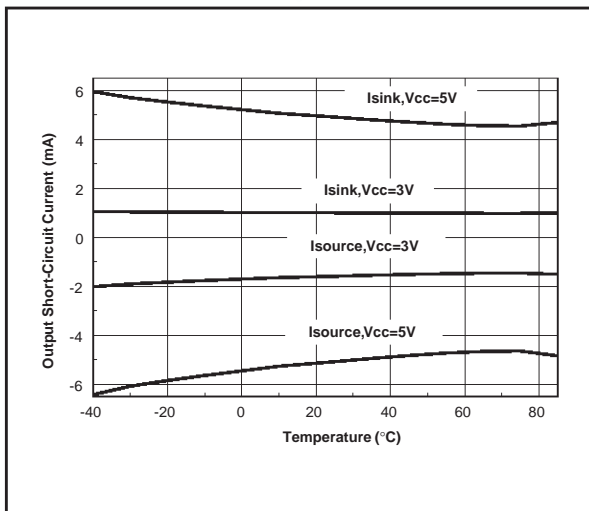
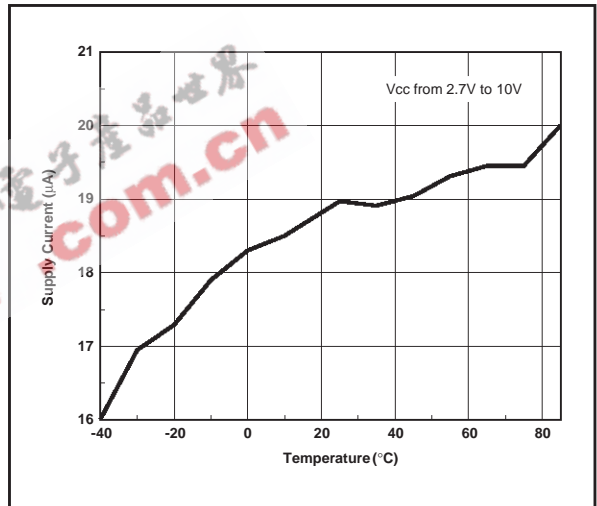
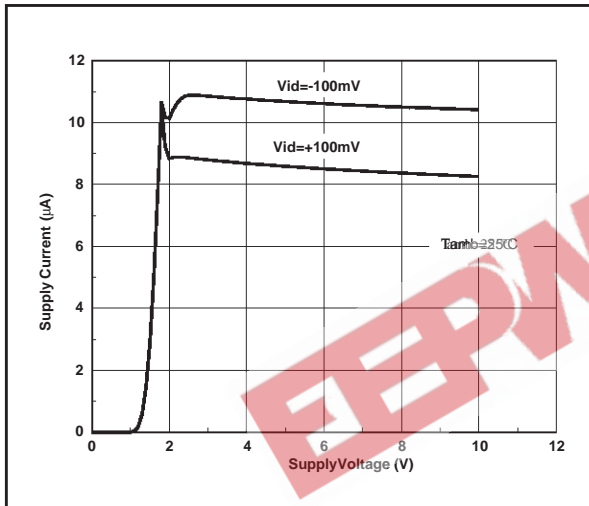
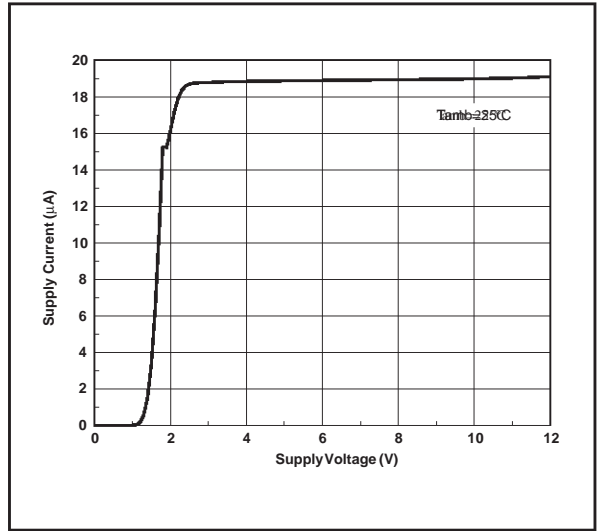
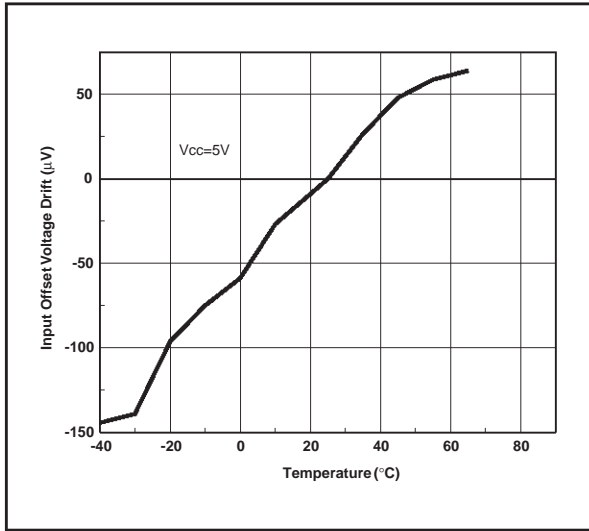

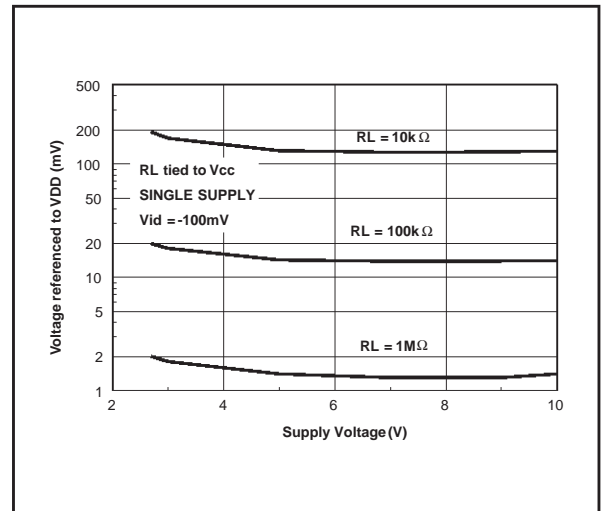
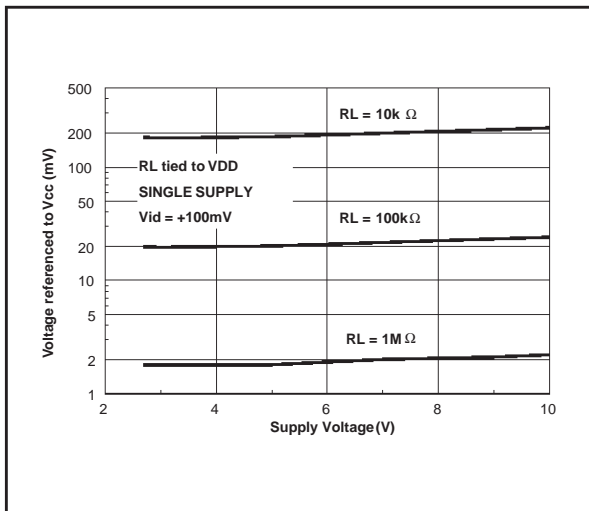
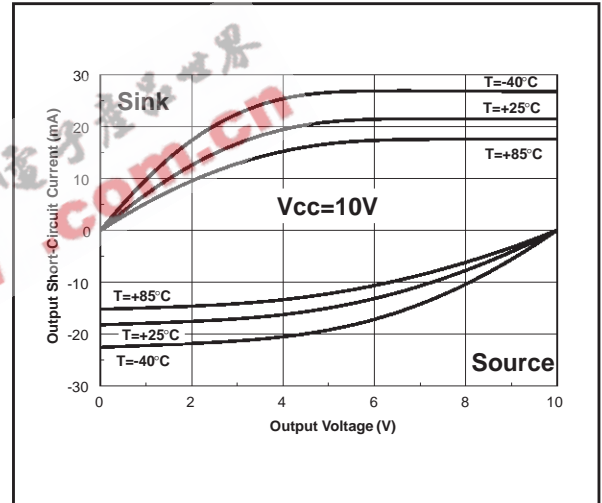
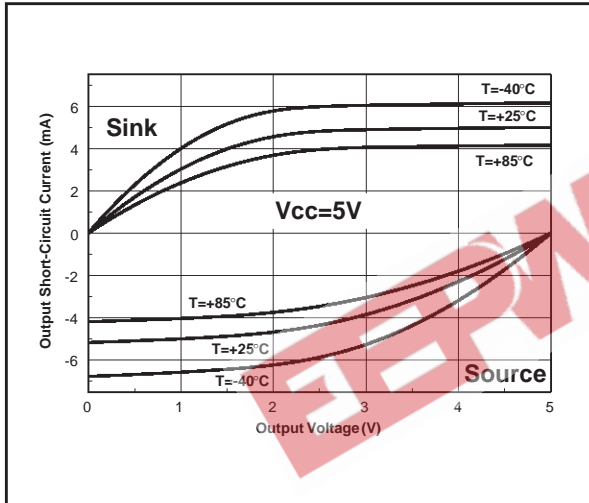
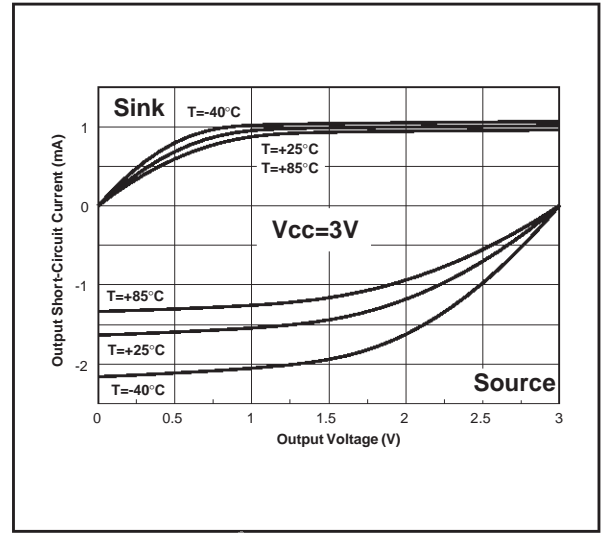
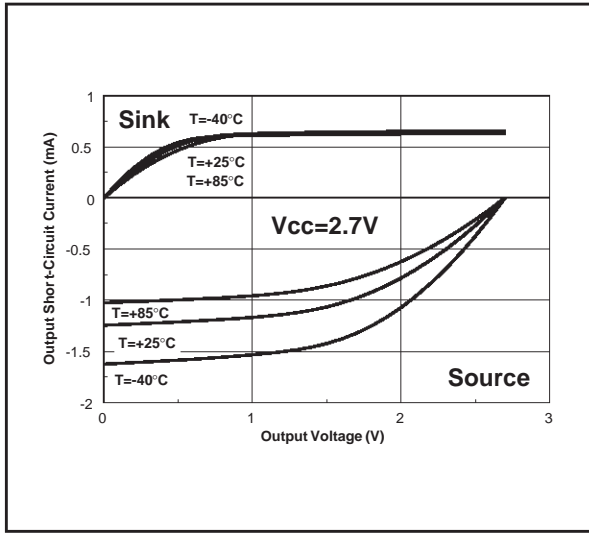

TS931-TS932-TS934

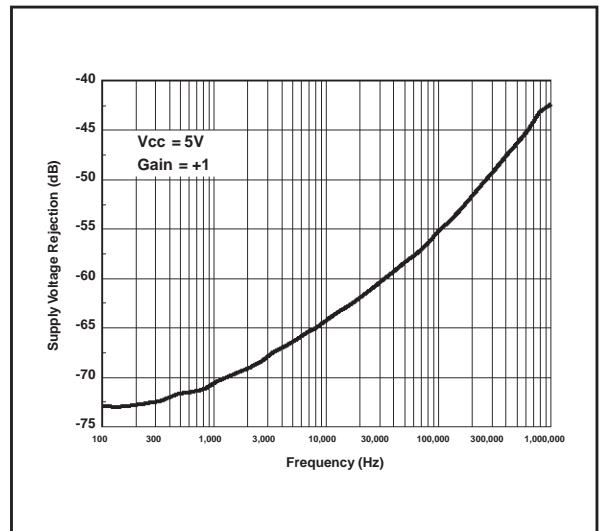
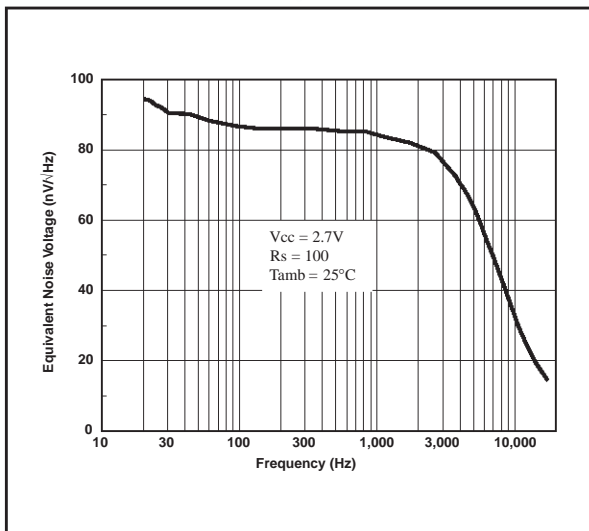
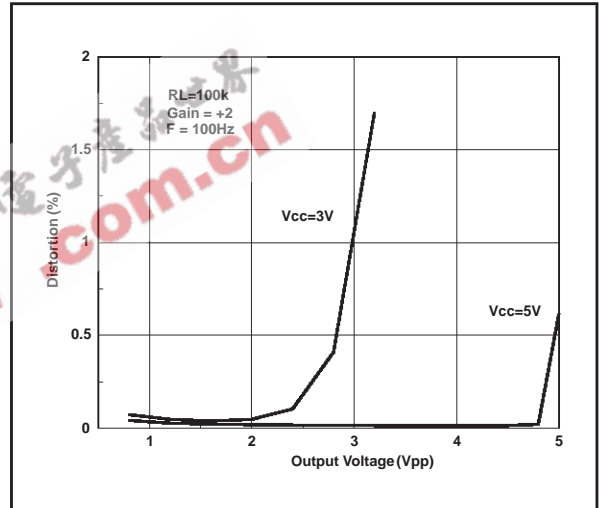
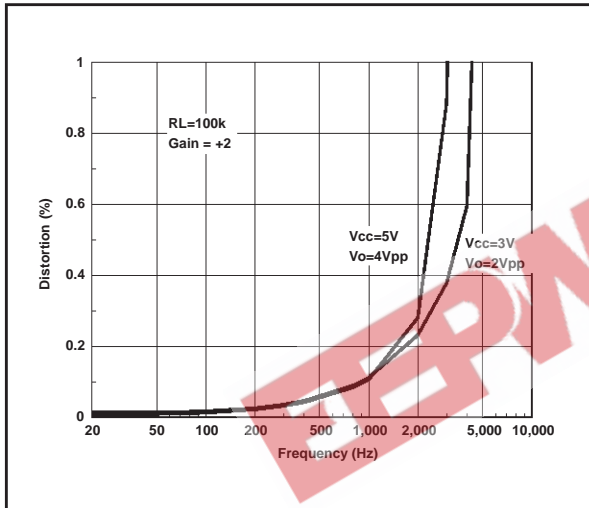
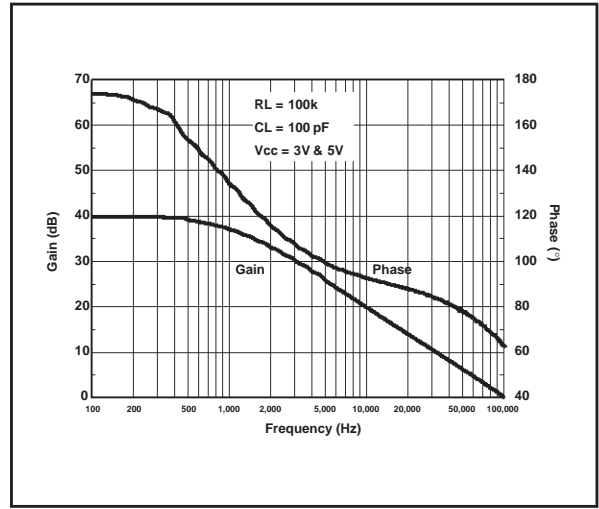
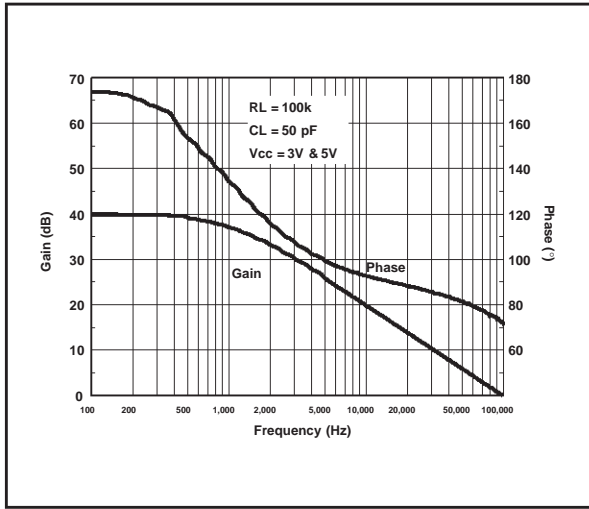

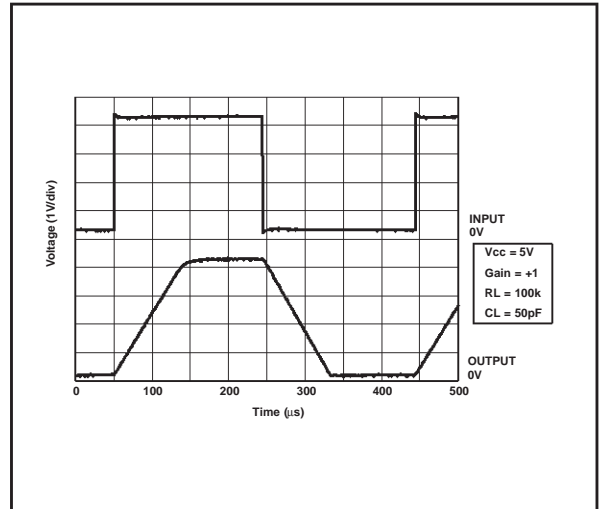
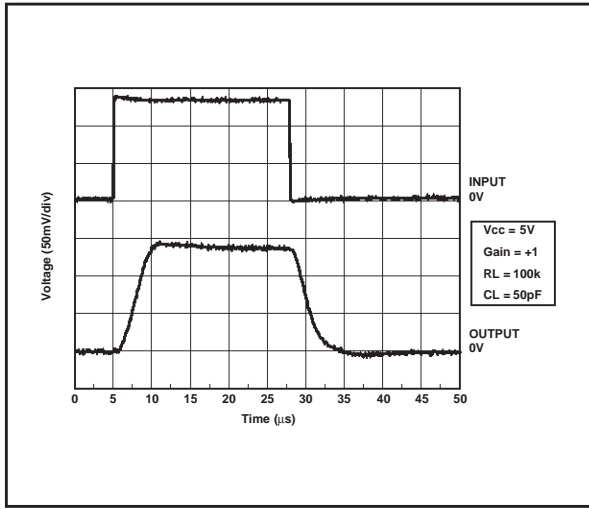

EEPW 电子产品世界 .com.cn

TS931-TS932-TS934

TS932IN

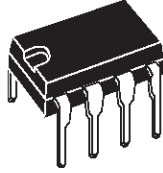

PACKAGE MECHANICAL DATA
8 PINS - PLASTIC PACKAGE

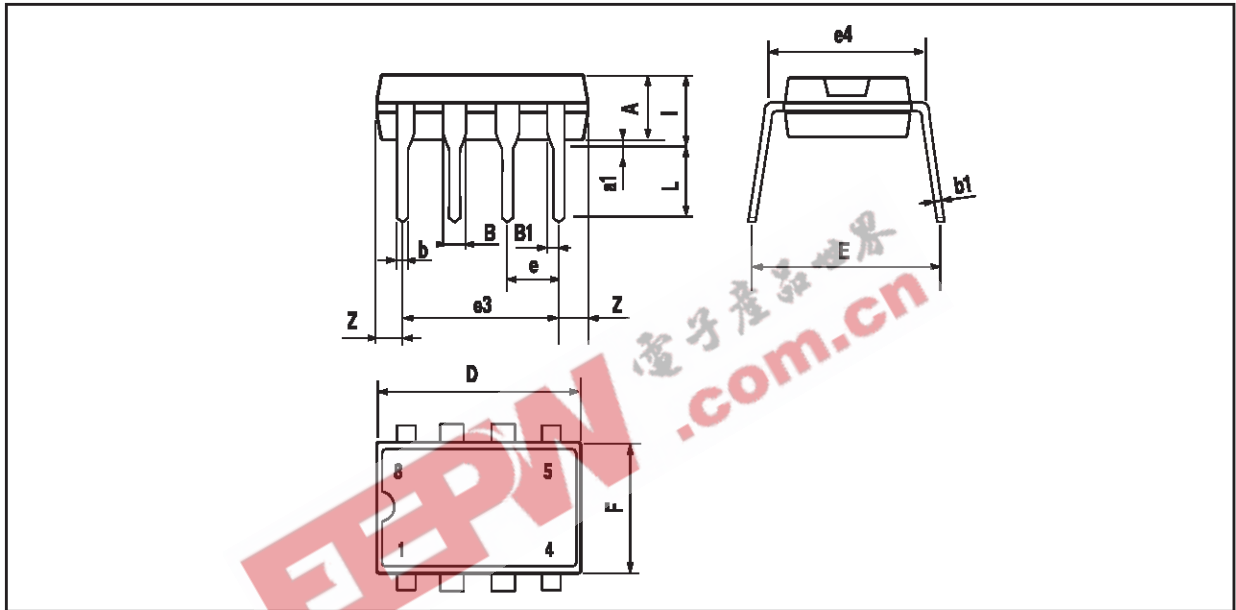

Dim.	Millimeters			Inches		
	Min.	Typ.	Max.	Min.	Typ.	Max.
A		3.32			0.131	
a1	0.51			0.020		
B	1.15		1.65	0.045		0.065
b	0.356		0.55	0.014		0.022
b1	0.204		0.304	0.008		0.012
D			10.92			0.430
E	7.95		9.75	0.313		0.384
e		2.54			0.100	
e3		7.62			0.300	
e4		7.62			0.300	
F			6.6			0.260
i			5.08			0.200
L	3.18		3.81	0.125		0.150
Z			1.52			0.060

TS931ID - TS932ID

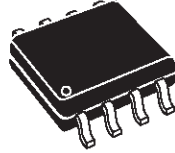

PACKAGE MECHANICAL DATA
8 PINS - PLASTIC MICROPACKAGE (SO)

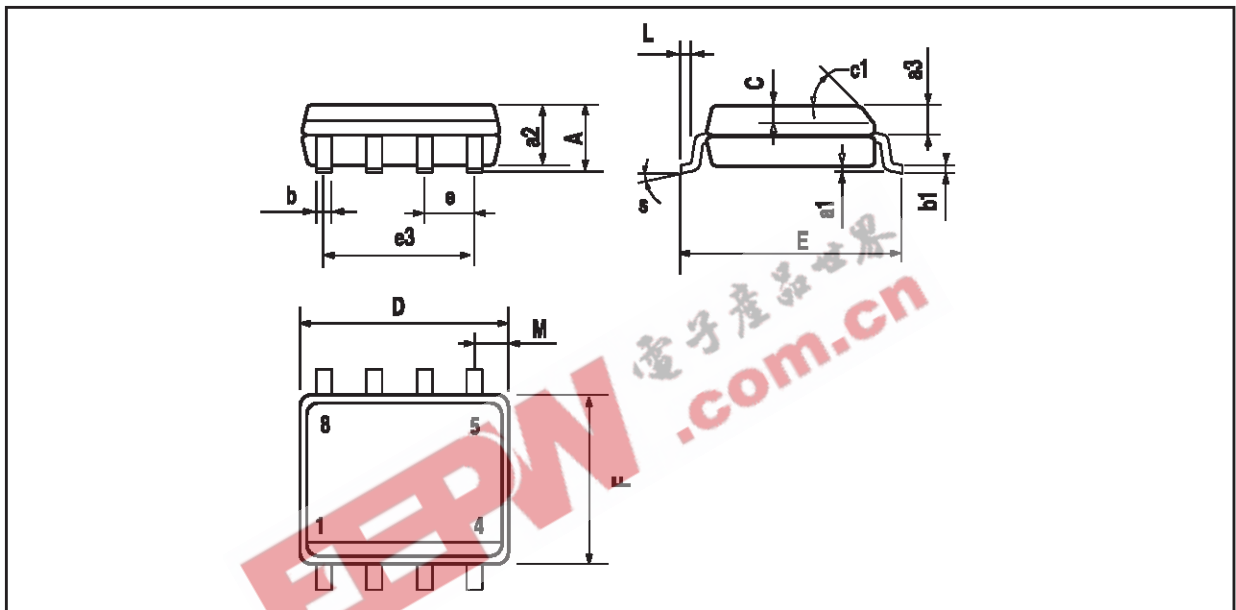

Dim.	Millimeters			Inches		
	Min.	Typ.	Max.	Min.	Typ.	Max.
A			1.75			0.069
a1	0.1		0.25	0.004		0.010
a2			1.65			0.065
a3	0.65		0.85	0.026		0.033
b	0.35		0.48	0.014		0.019
b1	0.19		0.25	0.007		0.010
C	0.25		0.5	0.010		0.020
c1	45° (typ.)					
D	4.8		5.0	0.189		0.197
E	5.8		6.2	0.228		0.244
e		1.27			0.050	
e3		3.81			0.150	
F	3.8		4.0	0.150		0.157
L	0.4		1.27	0.016		0.050
M			0.6			0.024
S	8° (max.)					

TS931-TS932-TS934

TS934IN

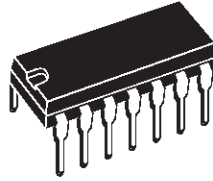

PACKAGE MECHANICAL DATA
14 PINS - PLASTIC PACKAGE

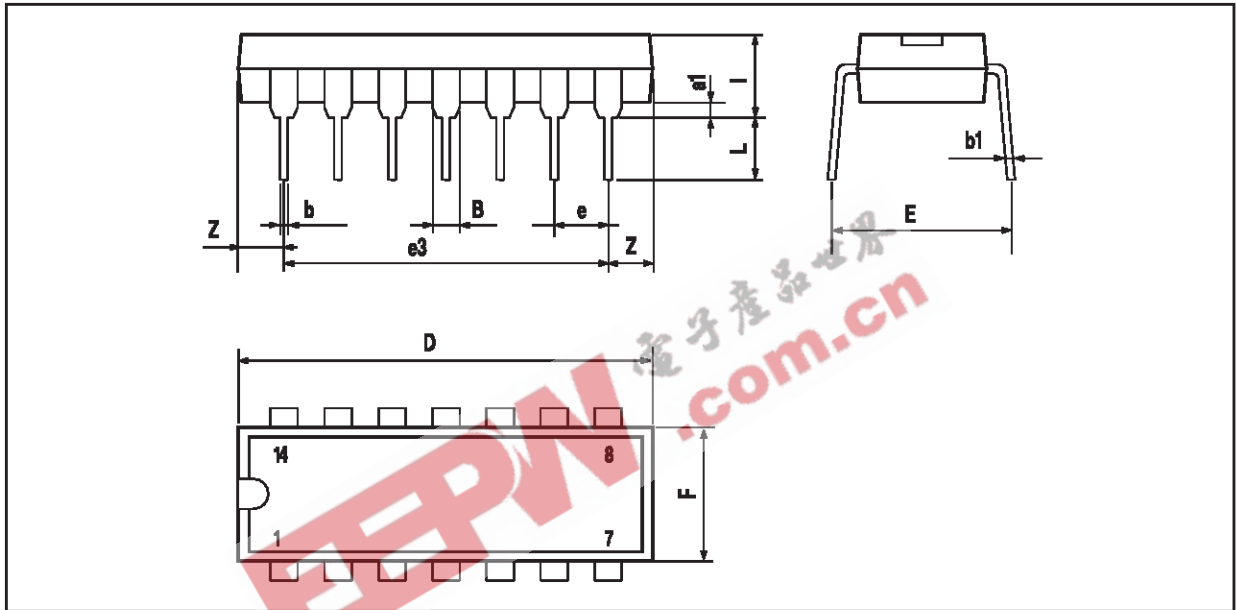

Dim.	Millimeters			Inches		
	Min.	Typ.	Max.	Min.	Typ.	Max.
a1	0.51			0.020		
B	1.39		1.65	0.055		0.065
b		0.5			0.020	
b1		0.25			0.010	
D			20			0.787
E		8.5			0.335	
e		2.54			0.100	
e3		15.24			0.600	
F			7.1			0.280
i			5.1			0.201
L		3.3			0.130	
Z	1.27		2.54	0.050		0.100

TS934ID

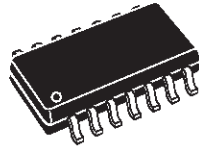

PACKAGE MECHANICAL DATA
14 PINS - PLASTIC MICROPACKAGE (SO)

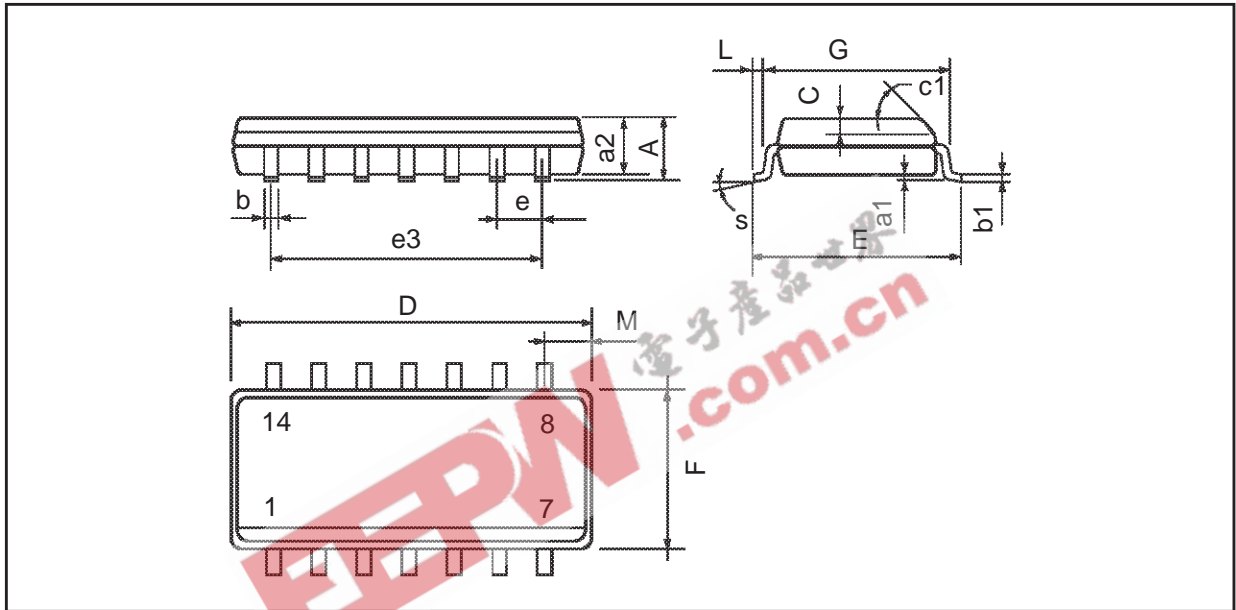

Dim.	Millimeters			Inches		
	Min.	Typ.	Max.	Min.	Typ.	Max.
A			1.75			0.069
a1	0.1		0.2	0.004		0.008
a2			1.6			0.063
b	0.35		0.46	0.014		0.018
b1	0.19		0.25	0.007		0.010
C		0.5			0.020	
c1	45° (typ.)					
D (1)	8.55		8.75	0.336		0.344
E	5.8		6.2	0.228		0.244
e		1.27			0.050	
e3		7.62			0.300	
F (1)	3.8		4.0	0.150		0.157
G	4.6		5.3	0.181		0.208
L	0.5		1.27	0.020		0.050
M			0.68			0.027
S	8° (max.)					

Note : (1) D and F do not include mold flash or protrusions - Mold flash or protrusions shall not exceed 0.15mm (.066 inc) ONLY FOR DATA BOOK.

TS931-TS932-TS934

TS934IPT

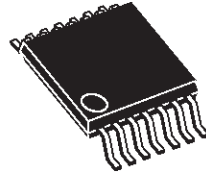

PACKAGE MECHANICAL DATA

14 PINS - THIN SHRINK SMALL OUTLINE PACKAGE

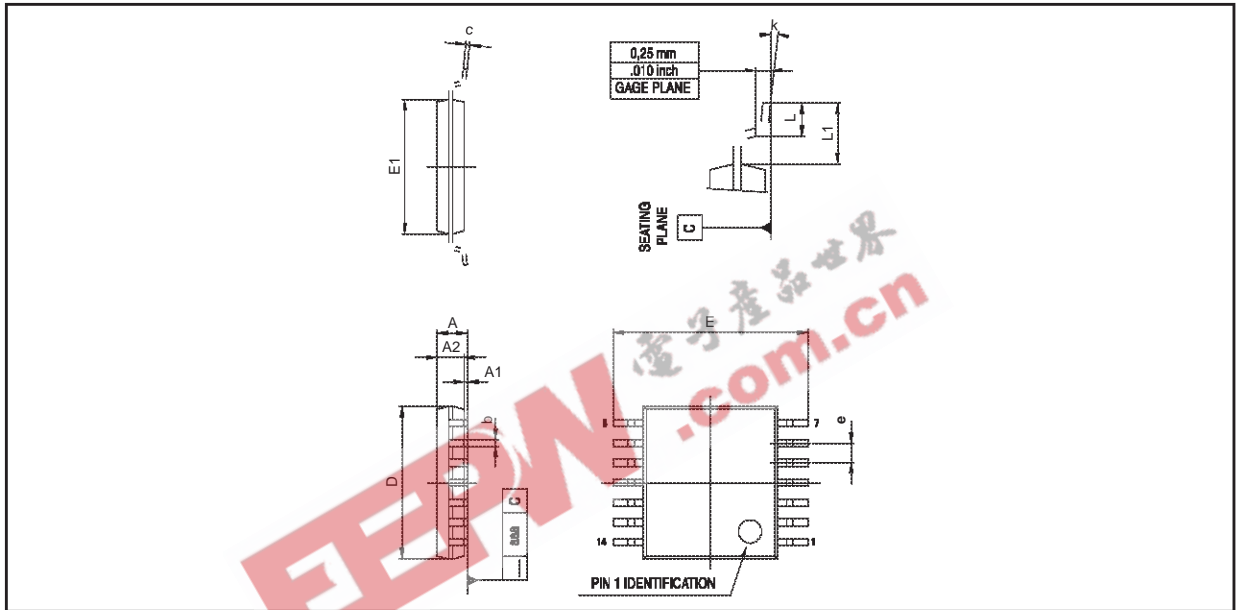

Dim.	Millimeters			Inches		
	Min.	Typ.	Max.	Min.	Typ.	Max.
A			1.20			0.05
A1	0.05		0.15	0.01		0.006
A2	0.80	1.00	1.05	0.031	0.039	0.041
b	0.19		0.30	0.007		0.15
c	0.09		0.20	0.003		0.012
D	4.90	5.00	5.10	0.192	0.196	0.20
E		6.40			0.252	
E1	4.30	4.40	4.50	0.169	0.173	0.177
e		0.65			0.025	
k	0°		8°	0°		8°
l	0.50	0.60	0.75	0.09	0.0236	0.030

TS931ILT

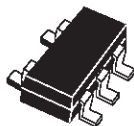
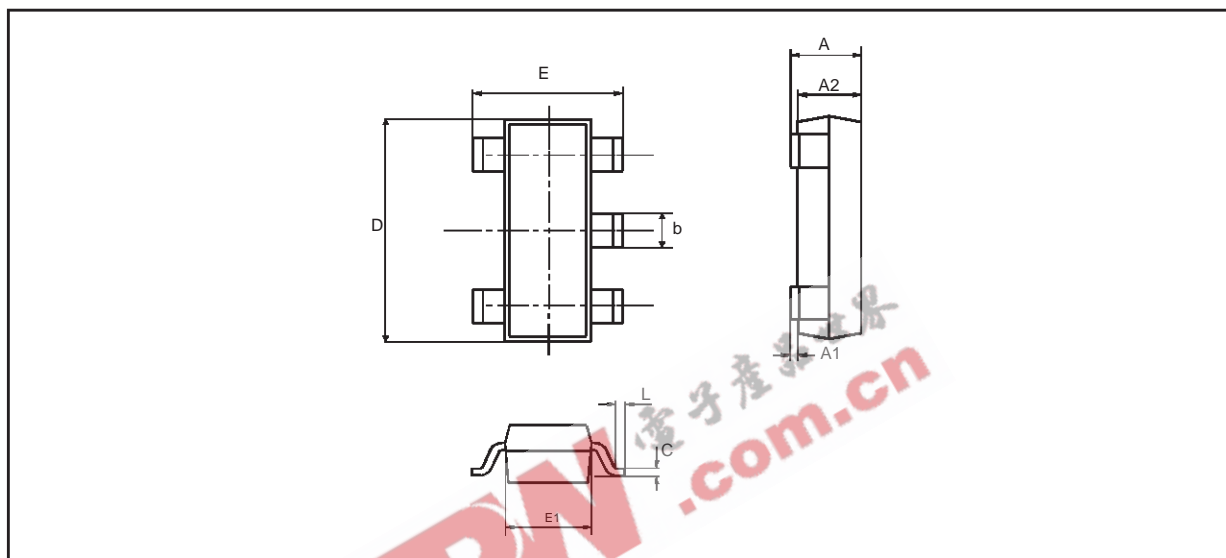
PACKAGE MECHANICAL DATA
 5 PINS - TINY PACKAGE (SOT23)

Dim.	Millimeters			Inches		
	Min.	Typ.	Max.	Min.	Typ.	Max.
A	0.90	1.20	1.45	0.035	0.047	0.057
A1	0		0.15			0.006
A2	0.90	1.05	1.30	0.035	0.041	0.051
B	0.35	0.40	0.50	0.014	0.016	0.020
C	0.09	0.15	0.20	0.004	0.006	0.008
D	2.80	2.90	3.00	0.110	0.114	0.118
D1		1.90			0.075	
e		0.95			0.037	
E	2.60	2.80	3.00	0.102	0.110	0.0118
F	1.50	1.60	1.75	0.059	0.063	0.069
L	0.10	0.5	0.60	0.004	0.014	0.024
K	0d		10d	0d		10d

Information furnished is believed to be accurate and reliable. However, STMicroelectronics assumes no responsibility for the consequences of use of such information nor for any infringement of patents or other rights of third parties which may result from its use. No license is granted by implication or otherwise under any patent or patent rights of STMicroelectronics. Specifications mentioned in this publication are subject to change without notice. This publication supersedes and replaces all information previously supplied. STMicroelectronics products are not authorized for use as critical components in life support devices or systems without express written approval of STMicroelectronics.

© The ST logo is a registered trademark of STMicroelectronics

© 2000 STMicroelectronics - Printed in Italy - All Rights Reserved
 STMicroelectronics GROUP OF COMPANIES

Australia - Brazil - China - Finland - France - Germany - Hong Kong - India - Italy - Japan - Malaysia - Malta - Morocco
 Singapore - Spain - Sweden - Switzerland - United Kingdom

© <http://www.st.com>