



	TS122	Units
Load Voltage	250	V
Load Current	170	mA
Max R <sub>ON</sub>	20	Ω

### Description

TS122 is a 250V, 170mA, 20Ω 1-Form-A relay with an optocoupler in a single package. It features enhanced peak load current handling capability for specific telecom applications.

### Features

- Small 8 Pin DIP Package
- Low Drive Power Requirements (TTL/CMOS Compatible)
- No Moving Parts
- High Reliability
- Arc-Free With No Snubbing Circuits
- 3750V<sub>RMS</sub> Input/Output Isolation
- FCC Compatible
- VDE Compatible
- No EMI/RFI Generation
- Machine Insertable, Wave Solderable
- Surface Mount and Tape & Reel Versions Available

### Approvals

- UL Recognized: File Number E76270
- CSA Certified: File Number LR 43639-10
- BSI Certified:
  - BS EN 60950:1992 (BS7002:1992) Certificate #: 7344
  - BS EN 41003:1993 Certificate #: 7344

### Applications

- Telecommunications
  - Telecom Switching
  - Tip/Ring Circuits
  - Modem Switching (Laptop, Notebook, Pocket Size)
  - Hookswitch
  - Dial Pulsing
  - Ground Start
  - Ringer Injection
- Instrumentation
  - Multiplexers
  - Data Acquisition
  - Electronic Switching
  - I/O Subsystems
  - Meters (Watt-Hour, Water, Gas)
- Medical Equipment-Patient/Equipment Isolation
- Security
- Aerospace
- Industrial Controls

### Ordering Information

Part #	Description
TS122	8 Pin DIP (50/Tube)
TS122P	8 Pin Flatpack (50/Tube)
TS122PTR	8 Pin Flatpack (1000/Reel)
TS122S	8 Pin Surface Mount (50/Tube)
TS122STR	8 Pin Surface Mount (1000/Reel)

### Pin Configuration

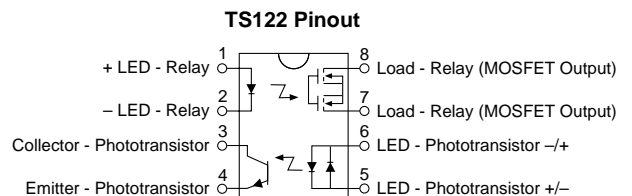

### Absolute Maximum Ratings (@ 25° C)

Parameter	Min	Typ	Max	Units
Input Power Dissipation	-	-	150 <sup>1</sup>	mW
Input Control Current Peak (10ms)	-	-	50 1	mA A
Reverse Input Voltage	-	-	5	V
Total Power Dissipation	-	-	800 <sup>2</sup>	mW
Isolation Voltage Input to Output	3750	-	-	V <sub>RMS</sub>
Operational Temperature	-40	-	+85	°C
Storage Temperature	-40	-	+125	°C
Soldering Temperature DIP Package	-	-	+260	°C
Flatpack/Surface Mount Package (10 Seconds Max.)	-	-	+220	°C

<sup>1</sup> Derate Linearly 1.33 mw/°C

<sup>2</sup> Derate Linearly 6.67 mw/°C

*Absolute Maximum Ratings are stress ratings. Stresses in excess of these ratings can cause permanent damage to the device. Functional operation of the device at these or any other conditions beyond those indicated in the operational sections of this data sheet is not implied. Exposure of the device to the absolute maximum ratings for an extended period may degrade the device and effect its reliability.*

### Electrical Characteristics

Parameter	Conditions	Symbol	Min	Typ	Max	Units
<b>Relay Portion (Pins 7, 8)</b>						
<b>Output Characteristics @ 25°C</b>						
Load Voltage (Peak)	-	VL	-	-	250	V
Load Current (Continuous)	-	IL	-	-	170	mA
Peak Load Current	10ms	ILPK	-	-	400	mA
On-Resistance	IL=170mA	RON	-	12	20	Ω
Off-State Leakage Current	VL=250V	ILEAK	-	-	1	μA
<b>Switching Speeds</b>						
Turn-On	IF=5mA, VL=10V	TON	-	-	5.0	ms
Turn-Off	IF=5mA, VL=10V	TOFF	-	-	5.0	ms
Output Capacitance	50V; f=1MHz	COUT	-	50	-	pF
<b>Relay Portion (Pins 1, 2)</b>						
<b>Input Characteristics @ 25°C</b>						
Input Control Current	IL=170mA	IF	5	-	50	mA
Input Dropout Current	-	IF	0.4	0.7	-	mA
Input Voltage Drop	IF=5mA	VF	0.9	1.2	1.4	V
Reverse Input Voltage	-	VR	-	-	5	V
Reverse Input Current	VR=5V	IR	-	-	10	μA

**Electrical Characteristics (Continued)**

Parameter	Conditions	Symbol	Min	Typ	Max	Units
<b>Detector Portion (Pins 3, 4)</b>						
<b>Output Characteristics @ 25°C</b>						
Phototransistor Blocking Voltage	$I_C=10\mu A$	$BV_{CEO}$	20	50	-	V
Phototransistor Output Current	$V_{CE}=5V, I_F=0mA$	$I_{CEO}$	-	50	500	nA
Saturation Voltage	$I_C=2mA, I_F=16mA$	$V_{SAT}$	-	0.3	0.5	V
Current Transfer Ratio	$I_F=6mA, V_{CE}=0.5V$	CTR	33	100	-	%
<b>Detector Portion (Pins 5, 6)</b>						
<b>Input Characteristics @ 25°C</b>						
Input Control Current	$I_C=2mA, V_{CE}=0.5V$	$I_F$	6	2	100	mA
Input Voltage Drop	$I_F=5mA$	$V_F$	0.9	1.2	1.4	V
Input Current (Detector must be off)	$I_C=1\mu A, V_{CE}=5V$	$I_F$	5	25	-	$\mu A$
Input to Output Capacitance (Relay Only)	-	$C_{I/O}$	-	3	-	pF
Capacitance Input to Output	-	-	-	3	-	pF
Input to Output Isolation	-	$V_{I/O}$	3750	-	-	$V_{RMS}$

EEPW.com.cn 电子产品世界

PERFORMANCE DATA\*

TS122  
Typical LED Forward Voltage Drop  
(N=50 Ambient Temperature = 25°C; I<sub>F</sub> = 5mADC)

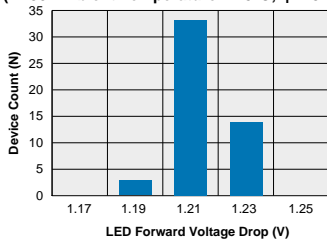

TS122  
Typical On-Resistance Distribution  
(N=50 Ambient Temperature = 25°C)  
(Load: Voltage = 250VDC; Current = 170mADC;  
I<sub>F</sub> = 5mADC)

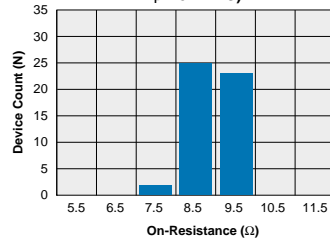

TS122  
Typical Blocking Voltage Distribution  
(N=50 Ambient Temperature = 25°C)

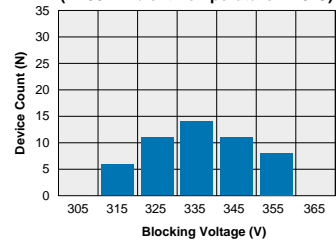

TS122  
Typical I<sub>F</sub> for Switch Operation  
(N=50 Ambient Temperature = 25°C)  
(Load Current = 170mADC)

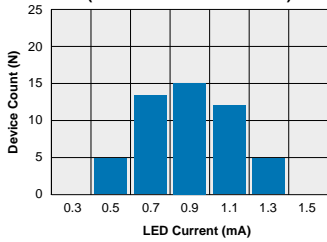

TS122  
Typical I<sub>F</sub> for Switch Dropout  
(N=50 Ambient Temperature = 25°C)  
(Load Current = 170mADC)

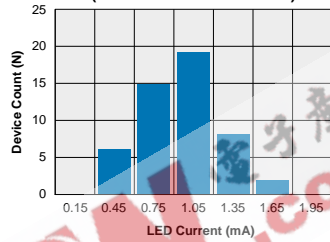

TS122  
Typical Turn-On Time  
(N=50 Ambient Temperature = 25°C)  
(Load Current = 170mADC; I<sub>F</sub> = 5mADC)

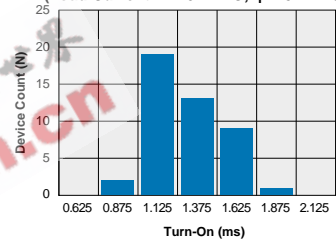

TS122  
Typical Turn-Off Time  
(N=50 Ambient Temperature = 25°C)  
(Load Current = 170mADC; I<sub>F</sub> = 5mADC)

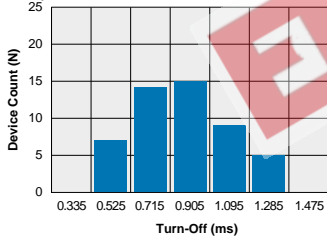

TS122  
Typical Load Current vs. Temperature

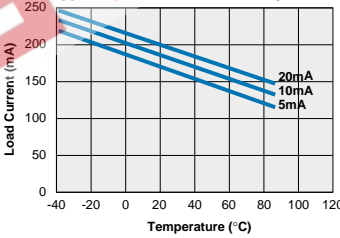

TS122  
Typical Leakage vs. Temperature  
(Measured across Pins 7 & 8)

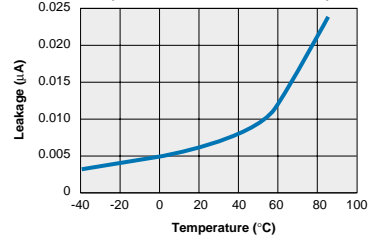

TS122  
Typical Blocking Voltage vs. Temperature

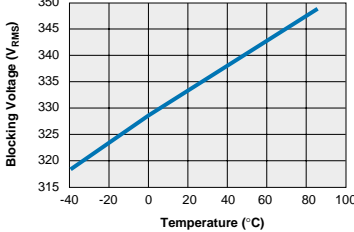

TS122  
Typical Turn-On vs. Temperature  
(Load Current = 170mADC)

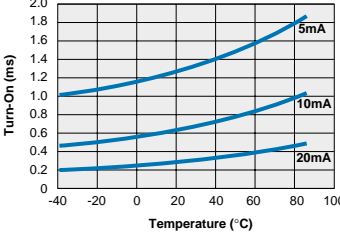

TS122  
Typical Turn-Off vs. Temperature  
(Load Current = 170mADC)

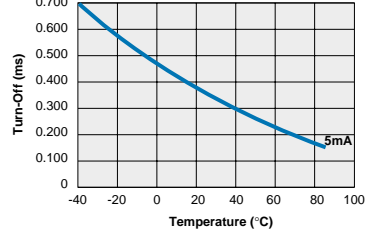

The Performance data shown in the graphs above is typical of device performance. For guaranteed parameters not indicated in the written specifications, please contact our application department.

PERFORMANCE DATA\*

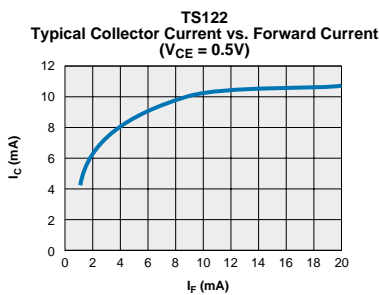
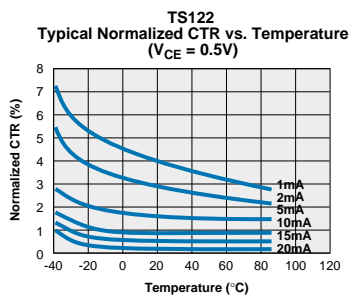
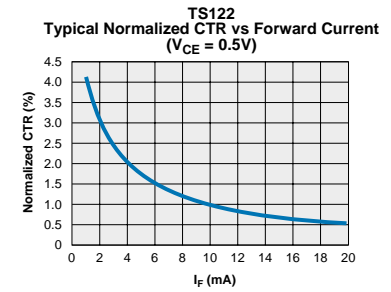
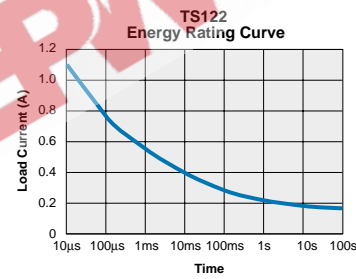
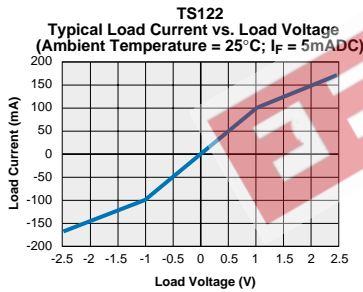
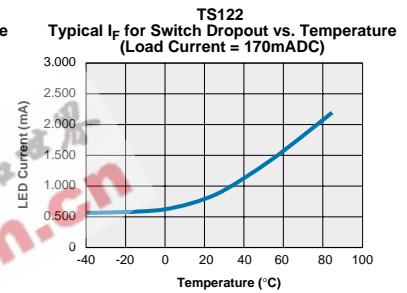
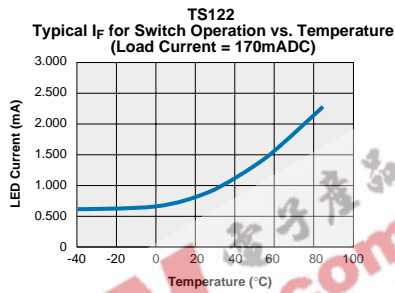
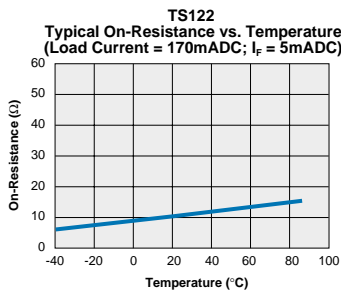
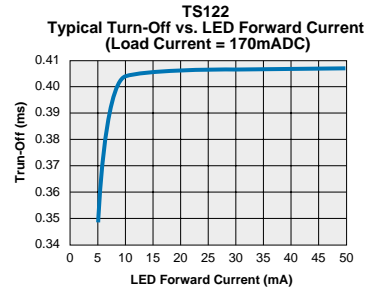
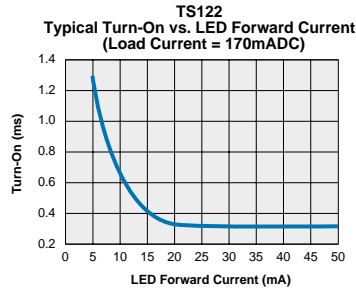
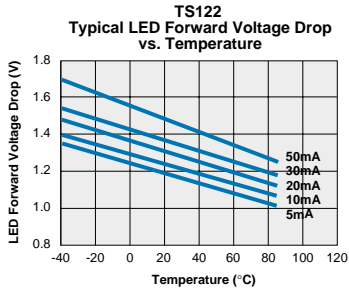

\*The Performance data shown in the graphs above is typical of device performance. For guaranteed parameters not indicated in the written specifications, please contact our application department.

Mechanical Dimensions

8 Pin DIP Through Hole (Standard)

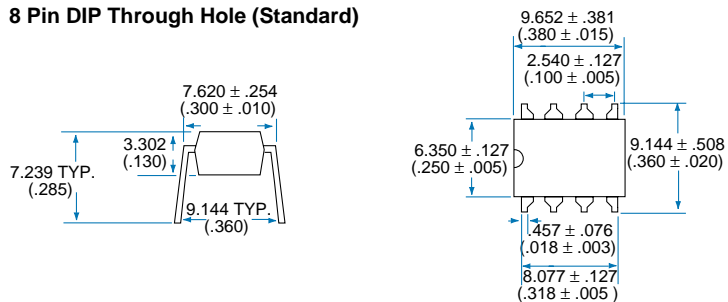

PC Board Pattern (Top View)

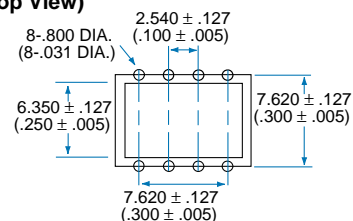

8 Pin DIP Surface Mount ("S" Suffix)

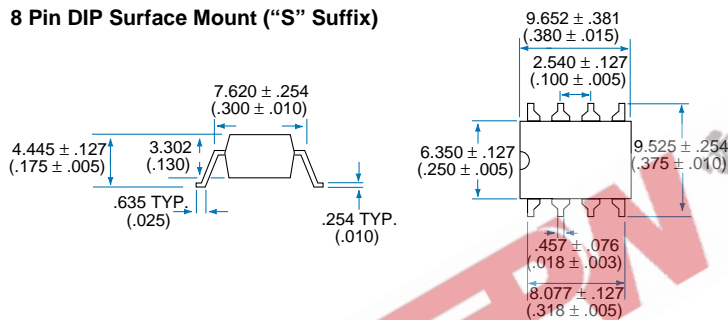

PC Board Pattern (Top View)

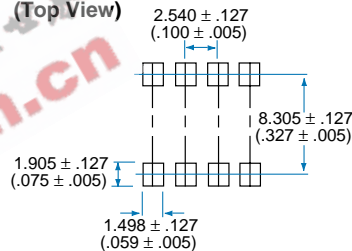

8 Pin Flatpack ("P" Suffix)

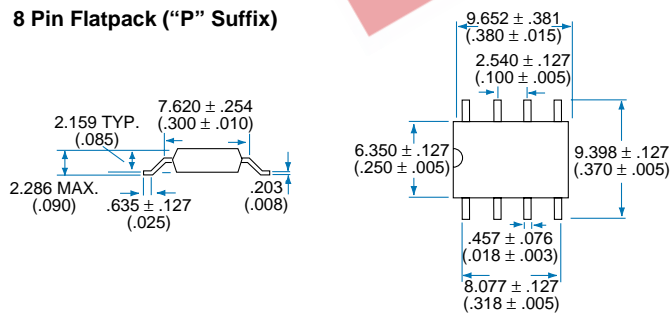

PC Board Pattern (Top View)

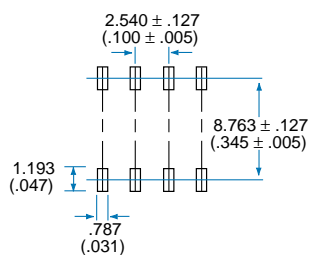

Dimensions  
 mm  
 (inches)





**CLARE**

MICRO CHIPS.  
MACRO SOLUTIONS.

## Worldwide Sales Offices

### CLARE LOCATIONS

Clare Headquarters  
78 Cherry Hill Drive  
Beverly, MA 01915  
Tel: 1-978-524-6700  
Fax: 1-978-524-4900  
Toll Free: 1-800-27-CLARE

Clare Micronix Division  
145 Columbia  
Aliso Viejo, CA 92656-1490  
Tel: 1-949-831-4622  
Fax: 1-949-831-4628

### SALES OFFICES

#### AMERICAS

**Americas Headquarters**  
Clare  
78 Cherry Hill Drive  
Beverly, MA 01915  
Tel: 1-978-524-6700  
Fax: 1-978-524-4900  
Toll Free: 1-800-27-CLARE

**Eastern Region**  
Clare  
P.O. Box 856  
Mahwah, NJ 07430  
Tel: 1-201-236-0101  
Fax: 1-201-236-8685  
Toll Free: 1-800-27-CLARE

**Central Region**  
Clare Canada Ltd.  
3425 Harvester Road, Suite 202  
Burlington, Ontario L7N 3N1  
Tel: 1-905-333-9066  
Fax: 1-905-333-1824

**Western Region**  
Clare  
1852 West 11th Street, #348  
Tracy, CA 95376  
Tel: 1-209-832-4367  
Fax: 1-209-832-4732  
Toll Free: 1-800-27-CLARE

**Canada**  
Clare Canada Ltd.  
3425 Harvester Road, Suite 202  
Burlington, Ontario L7N 3N1  
Tel: 1-905-333-9066  
Fax: 1-905-333-1824

### EUROPE

**European Headquarters**  
CP Clare nv  
Bampslaan 17  
B-3500 Hasselt (Belgium)  
Tel: 32-11-300868  
Fax: 32-11-300890

**France**  
Clare France Sales  
Lead Rep  
99 route de Versailles  
91160 Champlan  
France  
Tel: 33 1 69 79 93 50  
Fax: 33 1 69 79 93 59

**Germany**  
Clare Germany Sales  
ActiveComp Electronic GmbH  
Mitterstrasse 12  
85077 Manching  
Germany  
Tel: 49 8459 3214 10  
Fax: 49 8459 3214 29

**Italy**  
C.L.A.R.E.s.a.s.  
Via C. Colombo 10/A  
I-20066 Melzo (Milano)  
Tel: 39-02-95737160  
Fax: 39-02-95738829

**Sweden**  
Clare Sales  
Comptronic AB  
Box 167  
S-16329 Spånga  
Tel: 46-862-10370  
Fax: 46-862-10371

**United Kingdom**  
Clare UK Sales  
Marco Polo House  
Cook Way  
Bindon Road  
Taunton  
UK-Somerset TA2 6BG  
Tel: 44-1-823 352541  
Fax: 44-1-823 352797

### ASIA/PACIFIC

**Asian Headquarters**  
Clare  
Room N1016, Chia-Hsin, Bldg II,  
10F, No. 96, Sec. 2  
Chung Shan North Road  
Taipei, Taiwan R.O.C.  
Tel: 886-2-2523-6368  
Fax: 886-2-2523-6369

<http://www.clare.com>

---

*Clare cannot assume responsibility for use of any circuitry other than circuitry entirely embodied in this Clare product. No circuit patent licenses nor indemnity are expressed or implied. Clare reserves the right to change the specification and circuitry, without notice at any time. The products described in this document are not intended for use in medical implantation or other direct life support applications where malfunction may result in direct physical harm, injury or death to a person.*

---

Specification: DS-TS122-R7  
©Copyright 2000, Clare, Inc.  
All rights reserved. Printed in USA.  
2/27/01