



## TS391/A/B/C

## LINEAR INTEGRATED CIRCUIT

### LOW POWER SINGLE VOLTAGE COMPARATOR

#### DESCRIPTION

The UTC **TS391/A/B/C** consist of a low power voltage comparator designed specifically to operate from a single supply over a wide range of voltages. Operation from split power supplies is also possible.

This comparator also has a unique characteristic in that the input common-mode voltage range includes ground even though operated from a single power supply voltage.

#### FEATURES

- \* Wide single supply voltage range or dual supplies +2V ~ +34V or  $\pm 1V \sim \pm 18V$
- \* Very low supply current (0.2mA) independent of supply voltage (1mW /comparator at +5V)
- \* Low input bias current: 25nA typ.
- \* Low input offset current:  $\pm 5nA$  typ.
- \* Low input offset voltage:  $\pm 1mV$  typ
- \* Input common-mode voltage range includes ground.
- \* Low output saturation voltage: 250mV typ. ( $I_{out}=4mA$ ).
- \* Differential input voltage range equal to the supply voltage.

\*Pb-free plating product number:  
TS391L/TS391AL/TS391BL/TS391CL

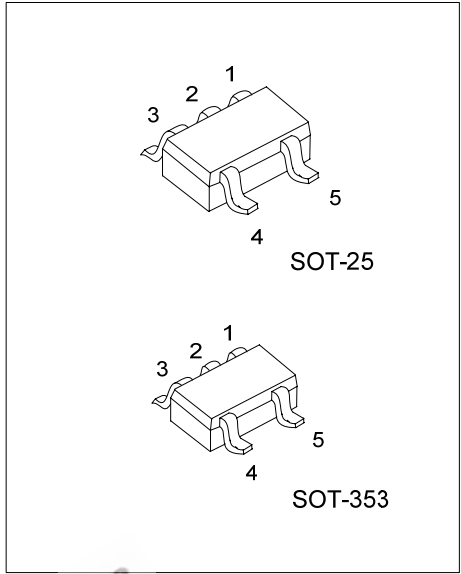

#### ORDERING INFORMATION

Order Number		Package	Packing
Normal	Lead Free Plating		
TS391-AF5-R	TS391L-AF5-R	SOT-25	Tape Reel
TS391A-AF5-R	TS391AL-AF5-R	SOT-25	Tape Reel
TS391B-AF5-R	TS391BL-AF5-R	SOT-25	Tape Reel
TS391C-AF5-R	TS391CL-AF5-R	SOT-25	Tape Reel
TS391-AL5-R	TS391L-AL5-R	SOT-353	Tape Reel
TS391A-AL5-R	TS391AL-AL5-R	SOT-353	Tape Reel
TS391B-AL5-R	TS391BL-AL5-R	SOT-353	Tape Reel
TS391C-AL5-R	TS391CL-AL5-R	SOT-353	Tape Reel

<p>TS391L-AF5-R</p> <p>(1)Packing Type (2)Package Type (3)Lead Plating</p>	<p>(1) R: Tape Reel (2) AF5: SOT-25 (3) L: Lead Free Plating, Blank: Pb/Sn</p>
--	--

# TS391/A/B/C

## LINEAR INTEGRATED CIRCUIT

### MARKING

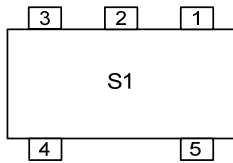

For TS391

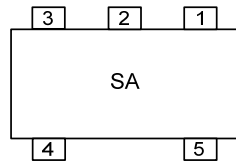

For TS391A

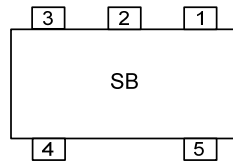

For TS391B

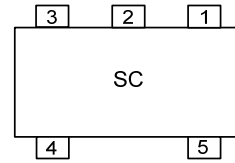

For TS391C

### PIN CONNECTIONS (top view)

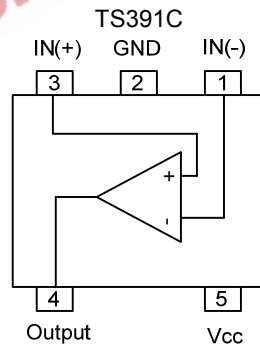
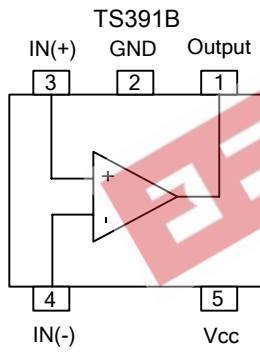
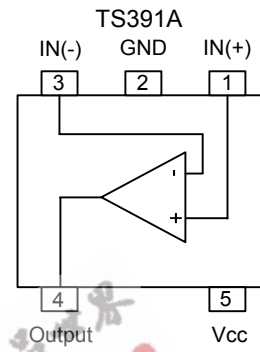
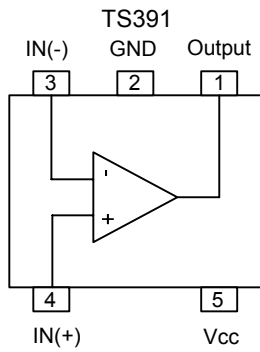

## ■ BLOCK DIAGRAM

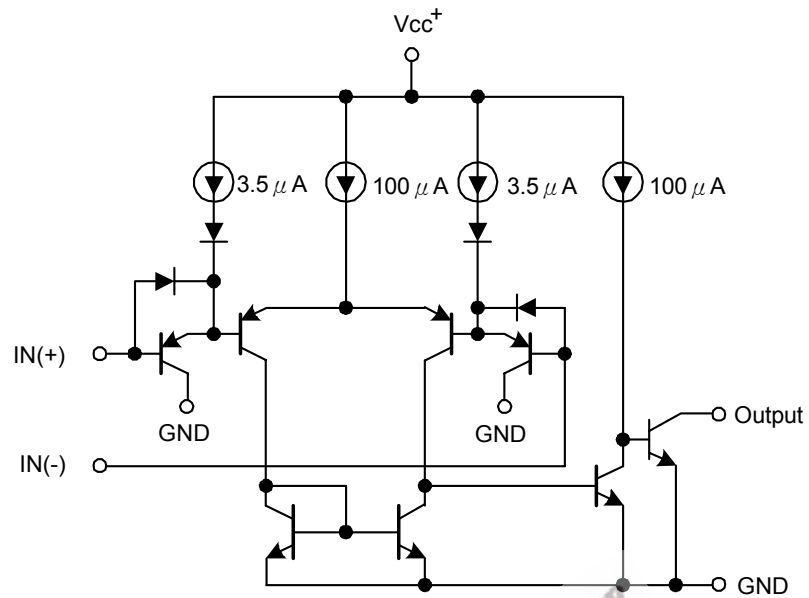

### ■ ABSOLUTE MAXIMUM RATINGS

PARAMETER	SYMBOL	RATING	UNIT
Supply Voltage	$V_{CC}$	$\pm 18$ or 36	V
Differential Input Voltage	$V_{I(DIFF)}$	$\pm 36$	V
Input Voltage	$V_{IN}$	-0.3 ~ +36	V
Output Short-Circuit to Ground <sup>1)</sup>		Infinite	
Power Dissipation	$P_D$	500	mW
Junction Temperature	$T_J$	150	°C
Operating Temperature	$T_{OPR}$	-40 ~ +125	°C
Storage Temperature	$T_{STG}$	-65 ~ +150	°C

Note 1. Absolute maximum ratings are those values beyond which the device could be permanently damaged.

Absolute maximum ratings are stress ratings only and functional device operation is not implied.

- Short-circuit from the output to  $V_{CC}$  can cause excessive heating and eventual destruction. The maximum output current is approximately 20mA, independent of the magnitude of  $V_{CC}$ .

### ■ THERMAL DATA ( $T_J=150^\circ\text{C}$ , $T_a=25^\circ\text{C}$ )

PARAMETER	SYMBOL	RATING	UNIT
Thermal resistance from junction to Ambient	$\theta_{JA}$	250	°C/W

### ■ ELECTRICAL CHARACTERISTICS

$V_{CC}=5.0\text{V}$ , All voltage referenced to GND,  $T_a=25^\circ\text{C}$  (unless otherwise specified)

PARAMETER	SYMBOL	TEST CONDITIONS	MIN	TYP	MAX	UNIT
Input Offset Voltage <sup>1)</sup>	$V_{I(OFF)}$	$T_a=+25^\circ\text{C}$		1	5	mV
		$T_{MIN} \leq T_a \leq T_{MAX}$			9	mV
Differential Input Voltage <sup>4)</sup>	$V_{I(DIFF)}$				$V_{CC}$	V
Large Signal Voltage Gain	$G_v$	$V_{CC}=15\text{V}$ , $R_L=15\text{k}\Omega$ , $V_{OUT}=1\sim 11\text{V}$	50	200		V/mV
Input Common Mode Voltage Range <sup>3)</sup>	$V_{I(CM)}$	$T_a=+25^\circ\text{C}$	0		$V_{CC}-1.5$	V
		$T_{MIN} \leq T_a \leq T_{MAX}$	0		$V_{CC}-2$	V
Low Level Output Voltage	$V_{OL}$	$V_{I(DIFF)}=1\text{V}$ , $V_{CC}=V_{OUT}=30\text{V}$	$T_a=+25^\circ\text{C}$	250	400	mV
			$T_{MIN} \leq T_a \leq T_{MAX}$			700
Input Bias Current <sup>2)</sup>	$I_{I(BIAS)}$	$T_a=+25^\circ\text{C}$		25	250	nA
		$T_{MIN} \leq T_a \leq T_{MAX}$			400	nA
Input Offset Current	$I_{I(OFF)}$	$T_a=+25^\circ\text{C}$		5	50	nA
		$T_{MIN} \leq T_a \leq T_{MAX}$			150	nA
Supply Current	$I_{CC}$	$V_{CC}=5\text{V}$ , no load		0.2	0.5	mA
		$V_{CC}=30\text{V}$ , no load		0.5	1.25	mA
Output sink current	$I_{SINK}$	$V_{I(DIFF)}=-1\text{V}$ , $V_{OUT}=1.5\text{V}$	6	16		mA
High Level Output Current	$I_{OH}$	$V_{I(DIFF)}=1\text{V}$ , $V_{CC}=V_{OUT}=30\text{V}$	$T_a=+25^\circ\text{C}$		0.1	nA
			$T_{MIN} \leq T_a \leq T_{MAX}$			1
Response Time	$t_r$	$R_L=5.1\text{k}\Omega$ to $V_{CC}$ <sup>5)</sup>		1.3		$\mu\text{s}$
Large Signal Response Time	$t_{rel}$	$V_{IN}=TTL$ , $V_{REF}=+1.4\text{V}$ , $R_L=5.1\text{k}\Omega \sim V_{CC}$		300		ns

1. At output switch point,  $V_o=1.4\text{V}$ ,  $R_s=0\Omega$  with  $V_{CC}$  from 5V ~ 30V and over the full input common-mode range(0V ~  $V_{CC}-1.5\text{V}$ ).

2. The direction of the input current is out of the IC due to the PNP input stage. This current is essentially constant, independent of the state of the output, so no loading charge exists on the reference or input lines.

3. The input common-mode voltage of either input signal voltage should not be allowed to go negative by more than 0.3V. The upper end of the common-mode voltage range is  $V_{CC} + -1.5\text{V}$ , but either or both inputs can go to +30V without damage.

4. Positive excursions of input voltage may exceed the power supply level. As long as the other voltage remains within the common-mode range the comparator will provide a proper output state.

The low input voltage state must not be less than -0.3V (or 0.3V below the negative power supply, if used).

5. The response time specified is for a 100mV input step with 5mV overdrive. For larger overdrive signals 300ns can be obtained.

## TYPICAL CHARACTERISTICS

Supply Current vs. Supply Voltage

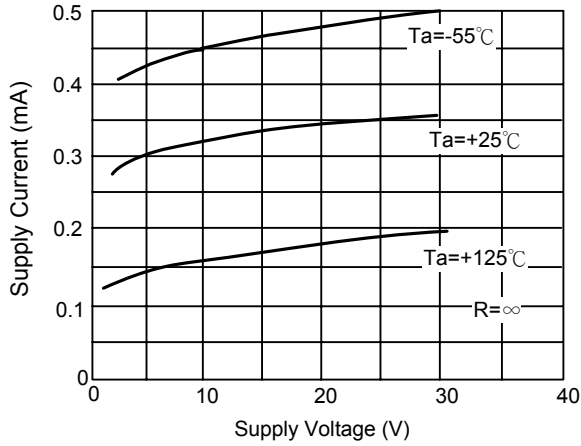

Response Time for vs. Input Overdrives - Negative Transition

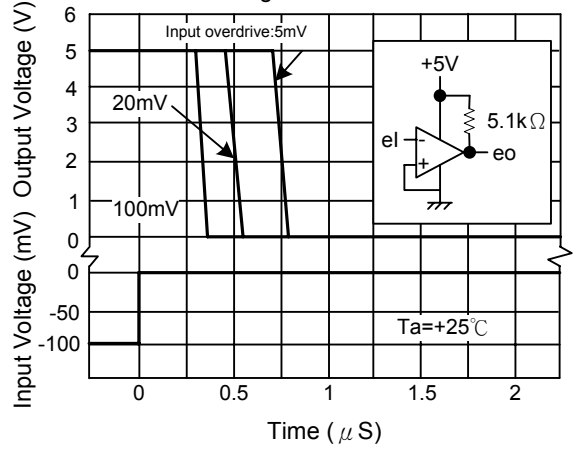

Input Current vs. Supply Voltage

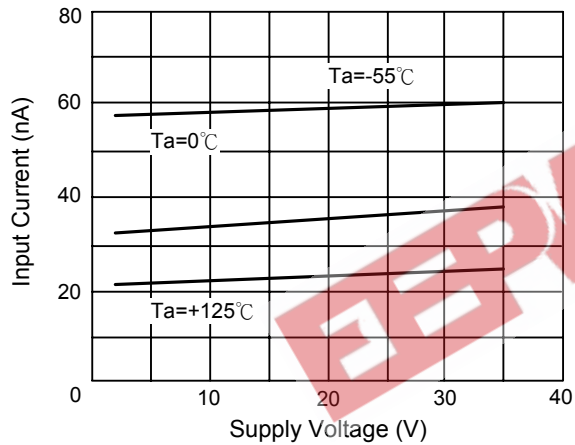

Response Time for vs. Input Overdrives - Positive Transition

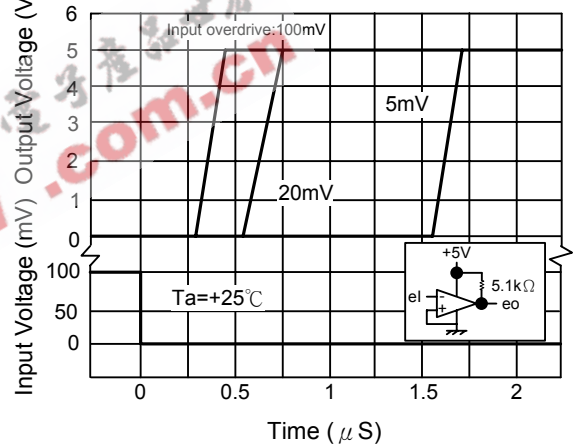

Output Saturation Voltage vs. Output Current

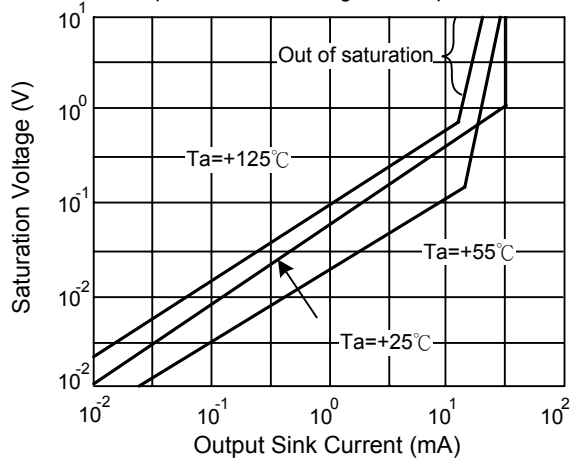

EEPW 电子產品世界  
.com.cn

UTC assumes no responsibility for equipment failures that result from using products at values that exceed, even momentarily, rated values (such as maximum ratings, operating condition ranges, or other parameters) listed in products specifications of any and all UTC products described or contained herein. UTC products are not designed for use in life support appliances, devices or systems where malfunction of these products can be reasonably expected to result in personal injury. Reproduction in whole or in part is prohibited without the prior written consent of the copyright owner. The information presented in this document does not form part of any quotation or contract, is believed to be accurate and reliable and may be changed without notice.