

Low Power Single Voltage Comparator

- Wide single supply voltage range or dual supplies +2V to +34V or $\pm 1V$ to $\pm 17V$
- Very low supply current (0.2mA) independent of supply voltage (1mW/comparator at +5V)
- Low input bias current: 25nA typ.
- Low input offset current: $\pm 5nA$ typ.
- Low input offset voltage: $\pm 1mV$ typ.
- Input common-mode voltage range includes ground
- Low output saturation voltage: 250mV typ. ($I_o=4mA$)
- Differential input voltage range equal to the supply voltage
- TTL, DTL, ECL, CMOS compatible outputs

Description

These devices consist of a low power voltage comparator designed specifically to operate from a single supply over a wide range of voltages. Operation from split power supplies is also possible.

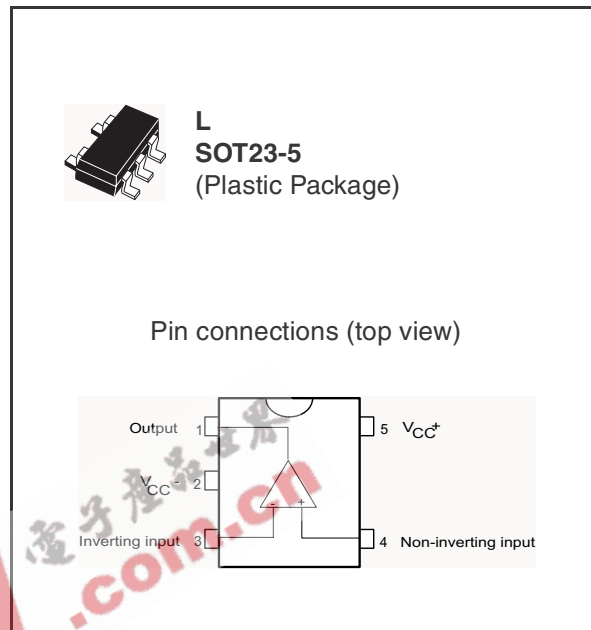

This comparator also has a unique characteristic in that the input common-mode voltage range includes ground even though operated from a single power supply voltage.

Order Codes

Part Number	Temperature Range	Package	Packaging	Marking
TS391ILT	-40°C, +125°C	SOT23-5L	Tape & Reel	K511
TS391IYLT				K510

1 Typical Application Schematic

Figure 1. Typical application schematic

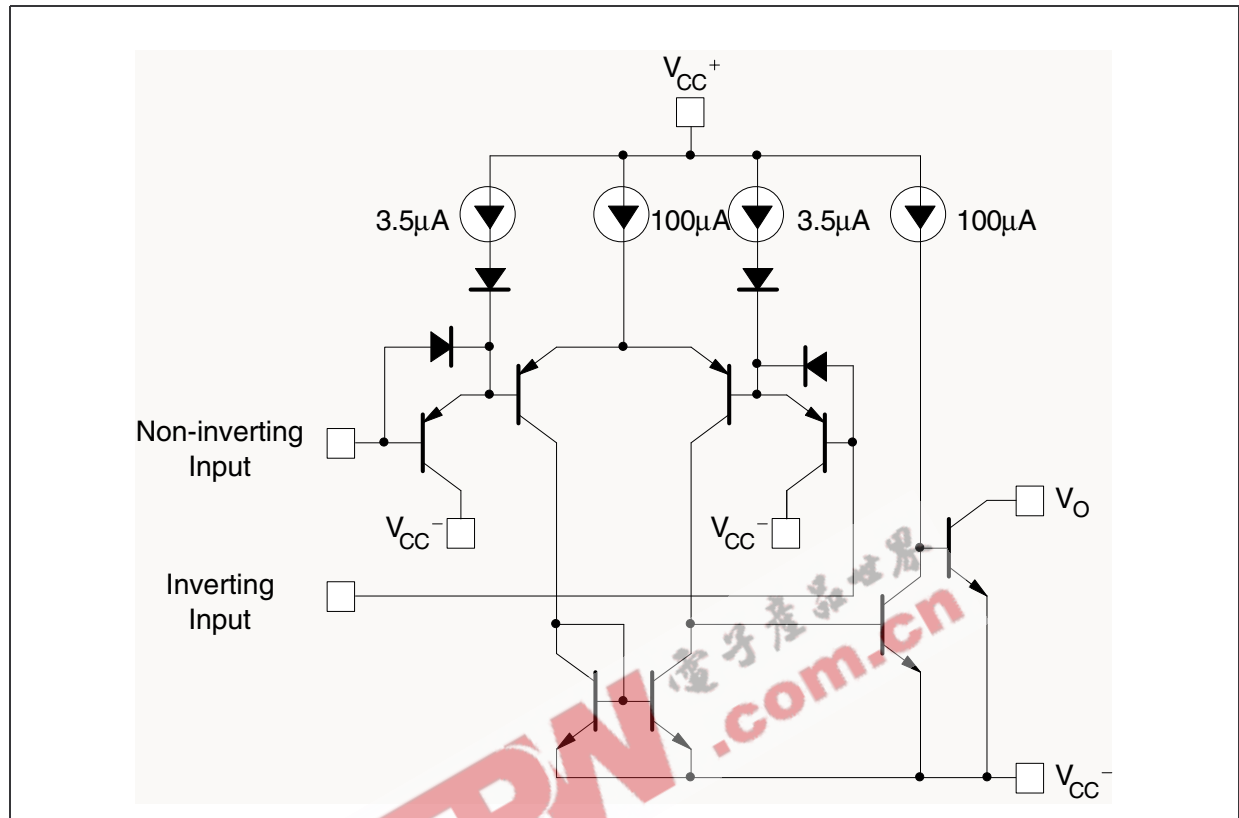

2 Absolute Maximum Ratings

Table 1. Key parameters and their absolute maximum ratings

Symbol	Parameter	Value	Unit
V_{CC}	Supply Voltage	± 18 or 34	V
V_{id}	Differential Input Voltage	± 34	V
V_i	Input Voltage	-0.3 to +34	V
	Output Short-circuit to Ground ⁽¹⁾	Infinite	
P_d	Power Dissipation ⁽²⁾	500	mW
T_{stg}	Storage Temperature Range	-65 to +150	°C

1. Short-circuits from the output to V_{CC}^+ can cause excessive heating and eventual destruction. The maximum output current is approximately 20mA independent of the magnitude of V_{CC}^+ .

2. $T_j = 150^\circ\text{C}$, $T_{amb} = 25^\circ\text{C}$ with $R_{thja} = 250^\circ\text{C/W}$ for SOT23-5 package.

Table 2. Operation conditions

Symbol	Parameter	Value	Unit
V_{CC}	Supply Voltage	2 to 34 ± 1 to ± 17	V
V_{icm}	Input Common Mode Voltage Range	0 to $V_{CC}^+ - 1.5$	V
T_{oper}	Operating Free Air Temperature Range	-40 to +125	°C

3 Electrical Characteristics

Table 3. $V_{CC}^+ = +5V$, $V_{CC}^- = 0V$, $T_{amb} = 25^\circ C$ (unless otherwise specified)

Symbol	Parameter	Conditions	Min.	Typ.	Max.	Unit
V_{io}	Input Offset Voltage ⁽¹⁾	$T_{min.} \leq T_{amb} \leq T_{max.}$		1	5 9	mV
I_{io}	Input Offset Current	$T_{min.} \leq T_{amb} \leq T_{max.}$		5	50 150	nA
I_{ib}	Input Bias Current ⁽²⁾	$T_{min.} \leq T_{amb} \leq T_{max.}$		25	250 400	nA
A_{vd}	Large Signal Voltage Gain	$V_{CC} = 15V$, $R_L = 15k\Omega$, $V_o = 1$ to $11V$	50	200		V/mV
I_{CC}	Supply Current	$V_{CC} = 5V$, no load $V_{CC} = 30V$, no load		0.2 0.5	0.5 1.25	mA
V_{icm}	Input Common Mode Voltage Range ⁽³⁾	$T_{min.} \leq T_{amb} \leq T_{max.}$	0 0		$V_{CC}^+ - 1.5$ $V_{CC}^+ - 2$	V
V_{id}	Differential Input Voltage ⁽⁴⁾				V_{CC}^+	V
I_{sink}	Output Sink Current	$V_{id} = -1V$, $V_o = 1.5V$	6	16		mA
V_{OL}	Low Level Output Voltage	$V_{id} = 1V$, $V_{CC} = V_o = 30V$, $T_{min.} \leq T_{amb} \leq T_{max.}$		250	400 700	mV
I_{OH}	High Level Output Current	$V_{id} = 1V$, $V_{CC} = V_o = 30V$, $T_{min.} \leq T_{amb} \leq T_{max.}$		0.1	1	nA μA
t_{re}	Small Signal Response Time	$R_L = 5.1k\Omega$ to V_{CC}^+ ⁽⁵⁾		1.3		μs
t_{rel}	Large Signal Response Time	$V_i = TTL$, $V_{ref} = +1.4V$, $R_L = 5.1k\Omega$ to V_{CC}^+		300		ns

1. At output switch point, $V_o \approx 1.4V$, $R_S = 0\Omega$ with V_{CC}^+ from 5V to 30V and over the full input common-mode range (0V to $V_{CC}^+ - 1.5V$).
2. The direction of the input current is out of the IC due to the PNP input stage. This current is essentially constant, independent of the state of the output, so no loading charge exists on the reference or input lines.
3. The input common-mode voltage of either input signal voltage should not be allowed to go negative by more than 0.3V. The upper end of the common-mode voltage range is $V_{CC}^+ - 1.5V$, but either or both inputs can go to +30V without damage.
4. Positive excursions of input voltage may exceed the power supply level. As long as the other voltage remains within the common-mode range the comparator will provide a proper output state. The low input voltage state must not be less than -0.3V (or 0.3V below the negative power supply, if used).
5. The response time specified is for a 100mV input step with 5mV overdrive. For larger overdrive signals 300ns can be obtained.

Figure 2. Supply current vs. supply voltage

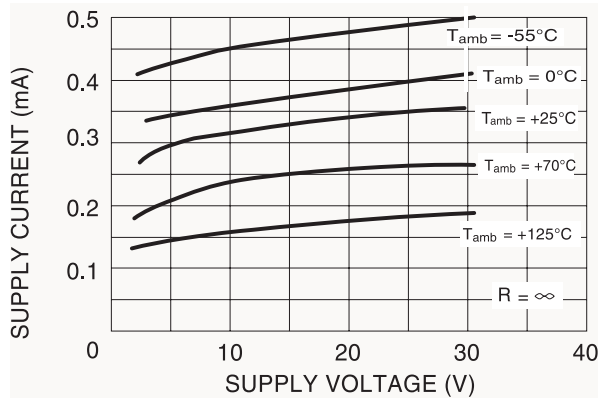

Figure 3. Response time for various input overdrives - negative transition

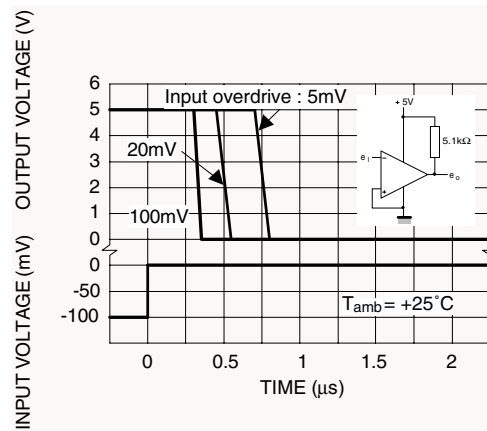

Figure 4. Input current vs. supply voltage

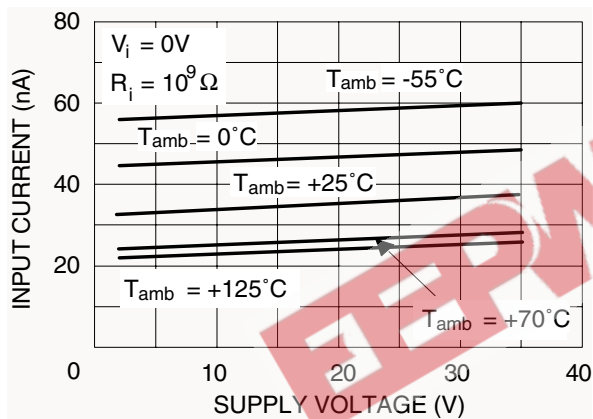

Figure 5. Response time for various input overdrives - positive transition

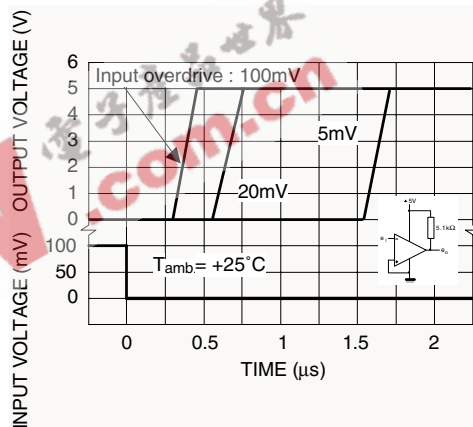
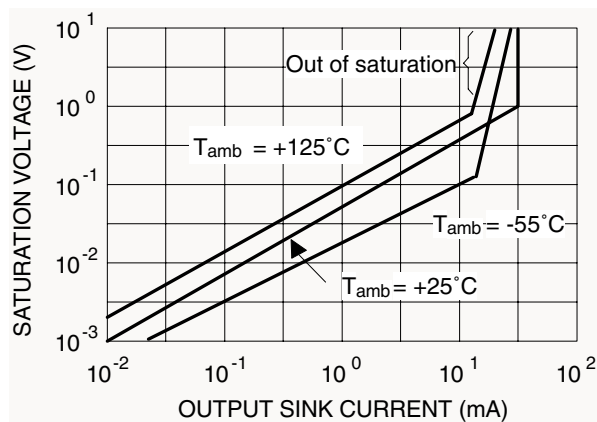

Figure 6. Output saturation voltage vs. output current



4 Package Mechanical Data

In order to meet environmental requirements, ST offers these devices in ECOPACK® packages. These packages have a Lead-free second level interconnect. The category of second level interconnect is marked on the package and on the inner box label, in compliance with JEDEC Standard JESD97. The maximum ratings related to soldering conditions are also marked on the inner box label. ECOPACK is an ST trademark. ECOPACK specifications are available at: www.st.com.

SOT23-5L Package

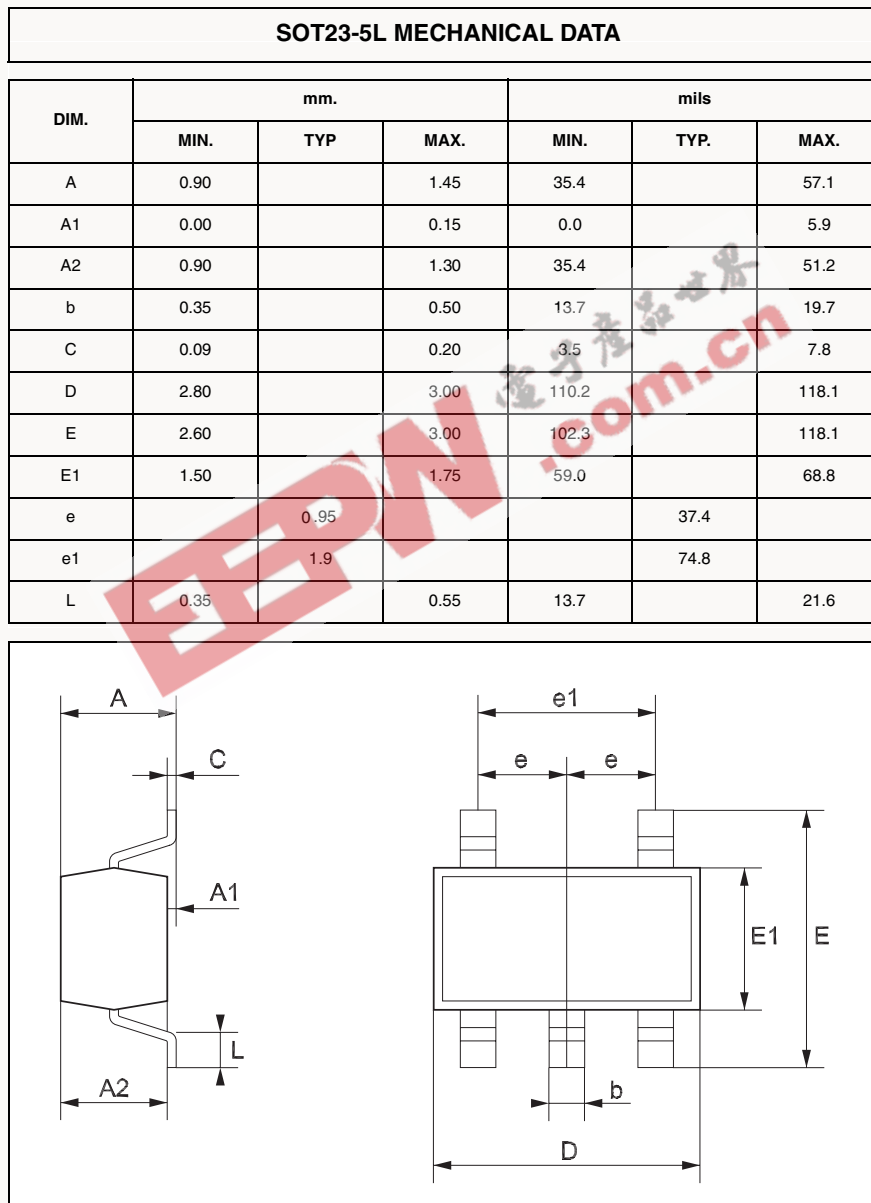

5 Revision history

Table 4. Document revision history

Date	Revision	Changes
Sept. 2004	1	Initial release.
Jan. 2006	2	PPAP reference inserted in the document.

EEPW 电子产品世界 .com.cn

Information furnished is believed to be accurate and reliable. However, STMicroelectronics assumes no responsibility for the consequences of use of such information nor for any infringement of patents or other rights of third parties which may result from its use. No license is granted by implication or otherwise under any patent or patent rights of STMicroelectronics. Specifications mentioned in this publication are subject to change without notice. This publication supersedes and replaces all information previously supplied. STMicroelectronics products are not authorized for use as critical components in life support devices or systems without express written approval of STMicroelectronics.

The ST logo is a registered trademark of STMicroelectronics.
All other names are the property of their respective owners

© 2006 STMicroelectronics - All rights reserved

STMicroelectronics group of companies

Australia - Belgium - Brazil - Canada - China - Czech Republic - Finland - France - Germany - Hong Kong - India - Israel - Italy - Japan - Malaysia - Malta - Morocco - Singapore - Spain - Sweden - Switzerland - United Kingdom - United States of America

www.st.com