



# TS941-TS942-TS944

## Output Rail-to-Rail Micropower Operational Amplifiers

- Rail-to-rail output voltage swing
- Micropower consumption (1.2 $\mu$ A)
- Single supply operation (2.5V to 10V)
- CMOS inputs
- Ultra low input bias current (1pA)
- ESD protection (2kV)
- Latch-up immunity (class A)
- Available in SOT23-5 micropackage

### Description

The TS94x (single, dual & quad) series are operational amplifiers characterized for 2.5V to 10V operation over -40°C to +85°C temperature range.

They exhibit excellent consumption - 1.2 $\mu$ A, while featuring 10kHz gain bandwidth product, 1.5mA output capability and output rail-to-rail operation - 2.85V typ @ 3V with  $R_L=10k\Omega$ .

The TS94x op-amps are ideal for battery-powered systems, where very low supply current and output rail-to-rail are required. Their very low - 1pA typ input bias current and constant supply current over supply voltage enhance TS94x's performance near the end of the life battery charge.

### Applications

- Battery-powered systems (alarm)
- Portable communication systems (pagers)
- Smoke/gas/fire detectors
- Instrumentation & sensing
- PH meter

### Pin Connections (top view)

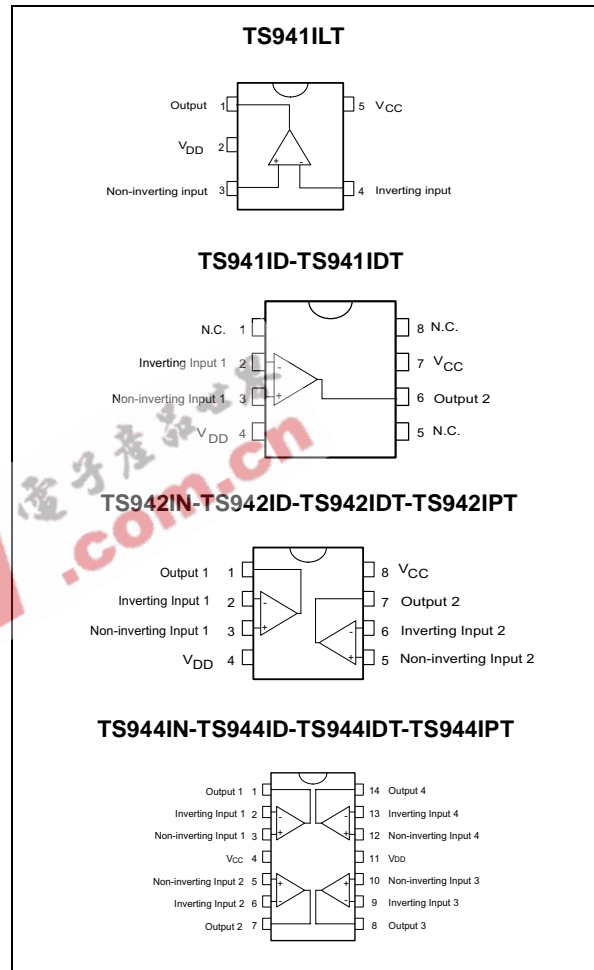

## TS941-TS942-TS944

### Order Codes

Part Number	Temperature Range	Package	Packaging	Marking
TS941ID/IDT/AID/AIDT/BID/BIDT	-40°C, +85°C	SO	Tube or Tape & Reel	
TS941ILT/AILT/BILT		SOT23-5L	Tape & Reel	K201 K202 K203
TS942IN/AIN/BIN		DIP	Tube	
TS942ID/IDT/AID/AIDT/BID/BIDT		SO	Tube or Tape & Reel	
TS942IPT/AIPT/BIPT		TSSOP (Thin Shrink Outline Package)	Tape & Reel	
TS944IN/AIN/BIN		DIP	Tube	
TS944ID/IDT/AID/AIDT/BIDT/BIDT		SO	Tube or Tape & Reel	
TS944IPT/AIPT/BIPT		TSSOP (Thin Shrink Outline Package)	Tape & Reel	

EEPW 电子产品世界  
.com.cn

## 1 Absolute Maximum Ratings

Table 1: Key parameters and their absolute maximum ratings

Symbol	Parameter	Value	Unit
VCC	Supply voltage <sup>1</sup>	12	V
V <sub>id</sub>	Differential Input Voltage <sup>2</sup>	±12	V
V <sub>in</sub>	Input Voltage Range <sup>3</sup>	V <sub>dd</sub> -0.3 to V <sub>cc</sub> +0.3	V
T <sub>std</sub>	Storage Temperature Range	-65 to +150	°C
T <sub>j</sub>	Maximum Junction Temperature	150	°C
R <sub>thja</sub>	Thermal Resistance Junction to Ambient <sup>4</sup>	250	°C/W
	SOT23-5	85	
	DIP8	66	
	DIP14	125	
	SO8	103	
	SO14	120	
	TSSOP8 TSSOP14	100	
ESD	HBM: Human Body Model <sup>5</sup>	2	kV
	MM: Machine Model <sup>6</sup> (TS941, TS942)	200	V
	CDM: Charged Device Model TS941	1.5	kV
	TS942	1	kV
	Latch-up Immunity	200	mA
	Lead Temperature (soldering, 10sec)	250	°C

1) All voltages values, except differential voltage are with respect to network terminal.

2) Differential voltages are non-inverting input terminal with respect to the inverting input terminal.

3) The magnitude of input and output voltages must never exceed V<sub>CC</sub> +0.3V.

4) Short-circuits can cause excessive heating and destructive dissipation.

5) Human body model, 100pF discharged through a 1.5kΩ resistor into pin of device.

6) Machine model ESD, a 200pF cap is charged to the specified voltage, then discharged directly into the IC with no external series resistor (internal resistor < 5Ω), into pin to pin of device.

Table 2: Operating Conditions

Symbol	Parameter	Value	Unit
VCC	Supply Voltage	2.5 to 10	V
V <sub>icm</sub>	Common Mode Input Voltage Range	V <sub>DD</sub> -0.2 to V <sub>CC</sub> -1.3	V
T <sub>oper</sub>	Operating Free Air Temperature Range	-40 to + 85	°C

## 2 Electrical Characteristics

Table 3:  $V_{CC} = +2.5V$ ,  $V_{DD} = 0V$ ,  $R_L$  connected to  $V_{CC/2}$ ,  $T_{amb} = 25^\circ C$  (unless otherwise specified)

Symbol	Parameter	Min.	Typ.	Max.	Unit
$V_{io}$	Input Offset Voltage TS941/2/4 TS941/2/4A TS941/2/4B			10 5 2	mV
$\Delta V_{io}$	Input Offset Voltage Drift		7		$\mu V/^\circ C$
$I_{io}$	Input Offset Current <sup>1)</sup>		1	100	pA
$I_{ib}$	Input Bias Current <sup>1)</sup>		1	150	pA
CMR	Common Mode Rejection Ratio	60	85		dB
SVR	Supply Voltage Rejection Ratio	50	78		dB
$A_{vd}$	Large Signal Voltage Gain $V_O = 2V_{pp}$ $R_L = 1M\Omega$		100		dB
$V_{OH}$	High Level Output Voltage $V_{ID} = 100mV$ $R_L = 1M\Omega$ $R_L = 10k\Omega$	2.45 2.3	2.49 2.4		V
$V_{OL}$	Low Level Output Voltage $V_{ID} = -100mV$ $R_L = 1M\Omega$ $R_L = 10k\Omega$		1 100	5 200	mV
$I_o$	Output Source Current $V_{ID} = 100mV$ , $V_O = V_{DD}$ Output Sink Current $V_{ID} = -100mV$ , $V_O = V_{CC}$	350 280	650 500		$\mu A$
$I_{CC}$	Supply Current (per amplifier) $A_{VCL} = 1$ , no load		1.2	1.8	$\mu A$
GBP	Gain Bandwidth Product $R_L = 1M\Omega$ , $C_L = 50pF$		10		kHz
SR	Slew Rate $R_L = 1M\Omega$ , $C_L = 50pF$	3	4.5		V/ms
$\phi_m$	Phase Margin $C_L = 50pF$		65		Degrees

1) Maximum values including unavoidable inaccuracies of the industrial test.

Table 4:  $V_{CC} = +3V$ ,  $V_{DD} = 0V$ ,  $R_L$  connected to  $V_{CC/2}$ ,  $T_{amb} = 25^\circ C$  (unless otherwise specified) <sup>2)</sup>

Symbol	Parameter	Min.	Typ.	Max.	Unit
$V_{io}$	Input Offset Voltage TS941/2/4 TS941/2/4A TS941/2/4B			10 5 2	mV
$\Delta V_{io}$	Input Offset Voltage Drift		7		$\mu V/^\circ C$
$I_{io}$	Input Offset Current <sup>1)</sup>		1	100	pA
$I_{ib}$	Input Bias Current <sup>1)</sup>		1	150	pA
CMR	Common Mode Rejection Ratio	60	85		dB
SVR	Supply Voltage Rejection Ratio	50	85		dB
$A_{vd}$	Large Signal Voltage Gain $V_O = 2V_{pp}$ , $R_L = 1M\Omega$		100		dB
$V_{OH}$	High Level Output Voltage $V_{ID} = 100mV$ $R_L = 1M\Omega$ $R_L = 10k\Omega$	2.9 2.8	2.99 2.85		V
$V_{OL}$	Low Level Output Voltage $V_{ID} = -100mV$ $R_L = 1M\Omega$ $R_L = 10k\Omega$		1 100	5 200	mV
$I_o$	Output Source Current $V_{ID} = 100mV$ , $V_O = V_{DD}$ Output Sink Current $V_{ID} = -100mV$ , $V_O = V_{CC}$	680 650	1500 1300		$\mu A$
$I_{CC}$	Supply Current (per amplifier) $A_{VCL} = 1$ , no load		1.2	1.8	$\mu A$
GBP	Gain Bandwidth Product $R_L = 1M\Omega$ , $C_L = 50pF$		10		kHz
SR	Slew Rate $R_L = 1M\Omega$ , $C_L = 50pF$	3	4.5		V/ms
$\phi_m$	Phase Margin $C_L = 50pF$		65		Degrees

1) Maximum values including unavoidable inaccuracies of the industrial test.

2. All electrical values are guaranteed with correlation measurements at 2.5V and 5V

Table 5:  $V_{CC} = +5V$ ,  $V_{DD} = 0V$ ,  $R_L$  connected to  $V_{CC}/2$ ,  $T_{amb} = 25^\circ C$  (unless otherwise specified)

Symbol	Parameter	Min.	Typ.	Max.	Unit
$V_{io}$	Input Offset Voltage TS941/2/4 TS941/2/4A TS941/2/4B			10 5 2	mV
$\Delta V_{io}$	Input Offset Voltage Drift		7		$\mu V/^\circ C$
$I_{io}$	Input Offset Current <sup>1)</sup>		1	100	pA
$I_{ib}$	Input Bias Current <sup>1)</sup>		1	150	pA
CMR	Common Mode Rejection Ratio	60	85		dB
SVR	Supply Voltage Rejection Ratio	50	85		dB
$A_{vd}$	Large Signal Voltage Gain $V_O = 2V_{pp}$ $R_L = 1M\Omega$		100		dB
$V_{OH}$	High Level Output Voltage $V_{ID} = 100mV$ $R_L = 1M\Omega$ $R_L = 10k\Omega$	4.9 4.8	4.99 4.85		V
$V_{OL}$	Low Level Output Voltage $V_{ID} = -100mV$ $R_L = 1M\Omega$ $R_L = 10k\Omega$		1 100	5 150	mV
$I_o$	Output Source Current $V_{ID} = 100mV, V_O = V_{DD}$ Output Sink Current $V_{ID} = -100mV, V_O = V_{CC}$	3 3.7	4.5 5		mA
$I_{CC}$	Supply Current (per amplifier) $A_{VCL} = 1$ , no load		1.2	1.85	$\mu A$
GBP	Gain Bandwidth Product $R_L = 1M\Omega, C_L = 50pF$		10		kHz
SR	Slew Rate $R_L = 1M\Omega, C_L = 50pF$	3	4.5		V/ms
$\phi_m$	Phase Margin $C_L = 50pF$		65		Degrees

1) Maximum values including unavoidable inaccuracies of the industrial test.

Figure 1:

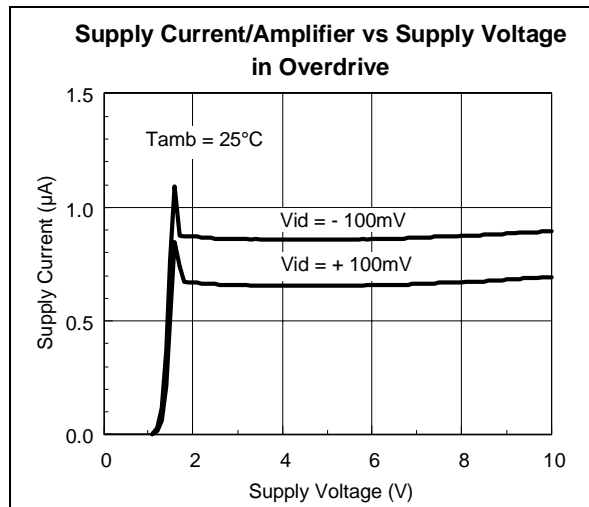

Figure 3:

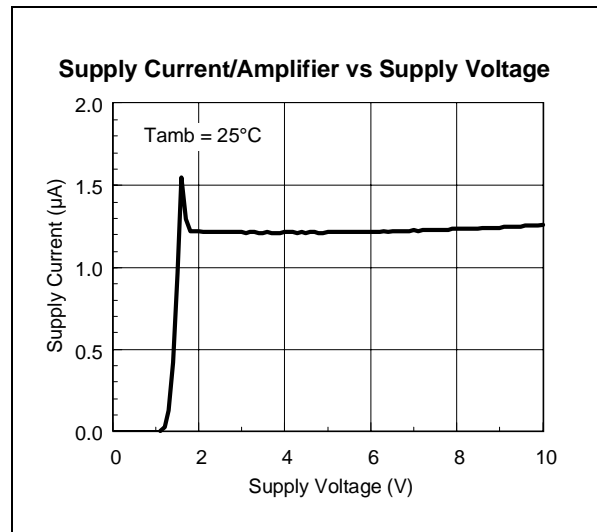

Figure 2:

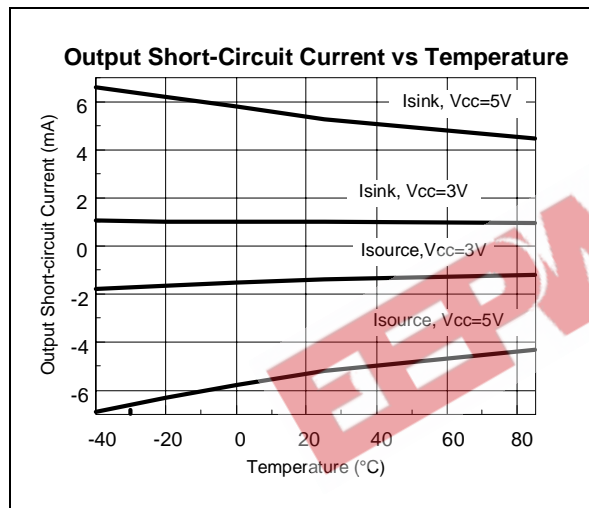

Figure 4:

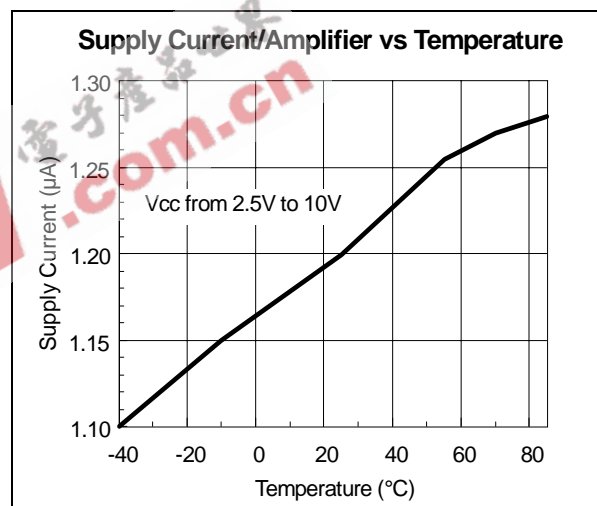

Figure 5:

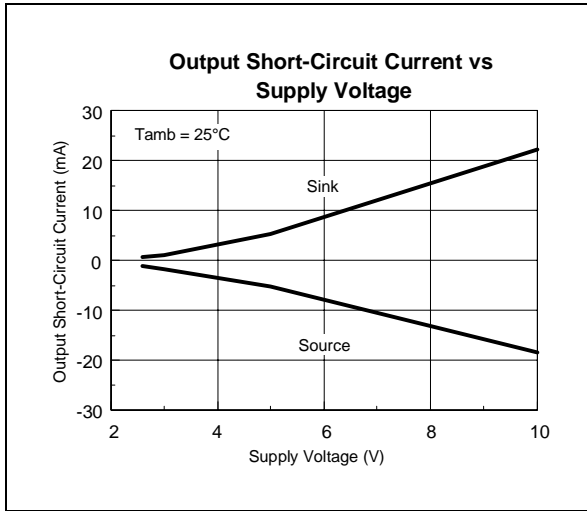

Figure 7:

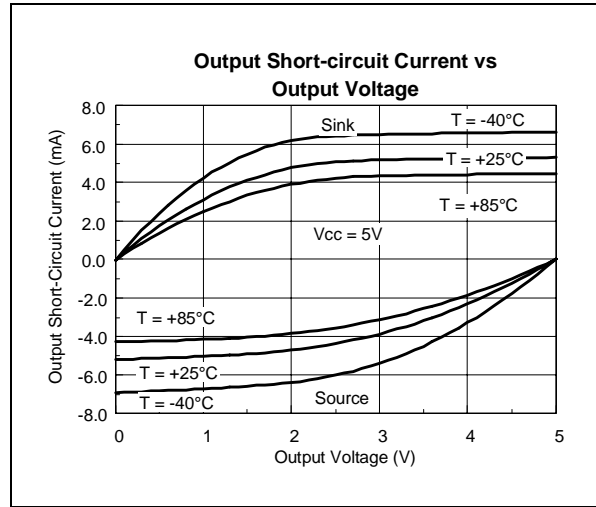

Figure 6:

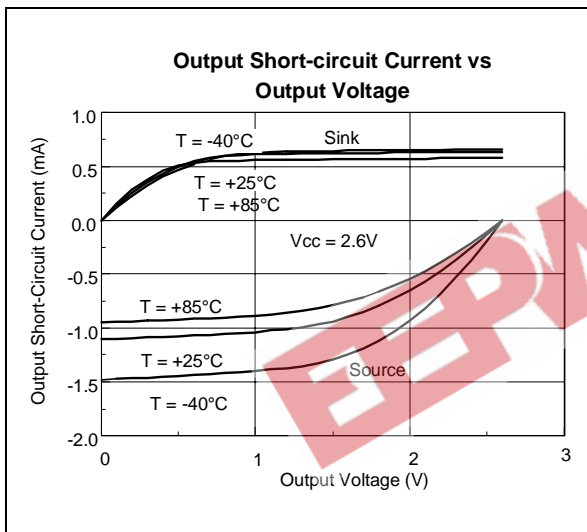

Figure 8:

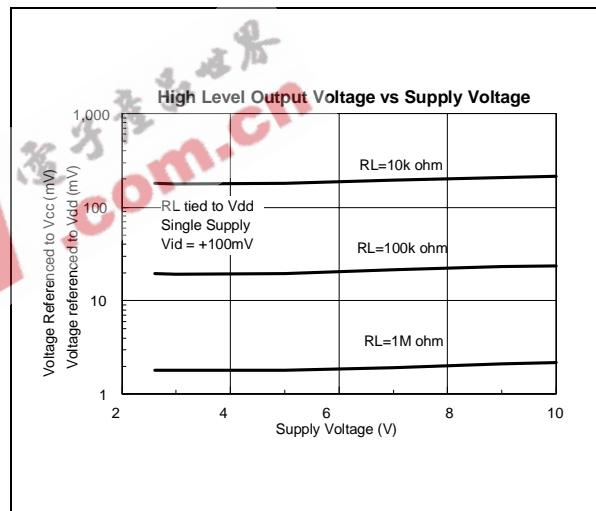



Figure 9:

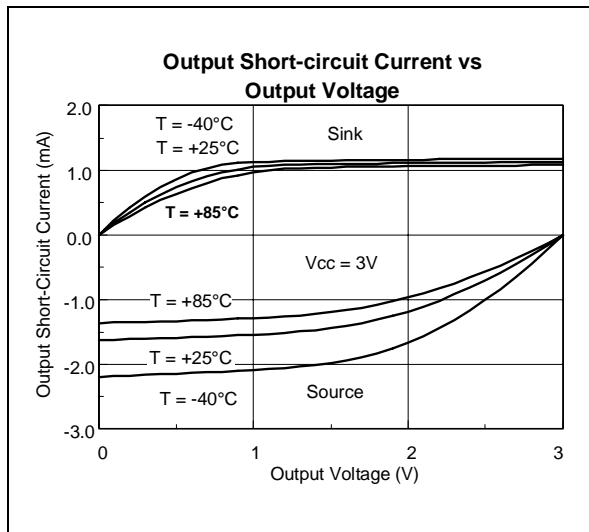

Figure 11:

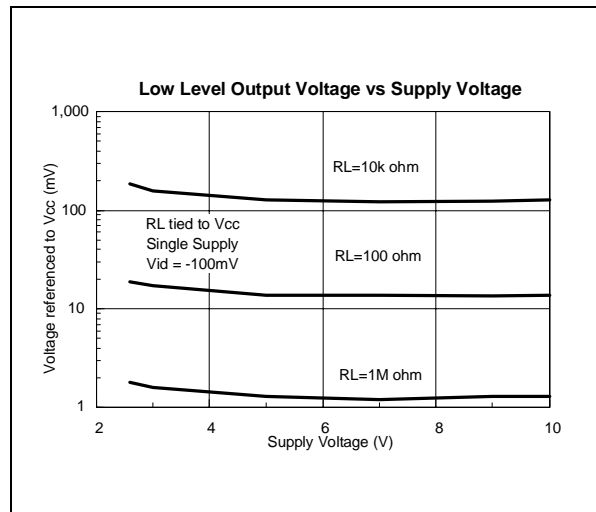

Figure 10:

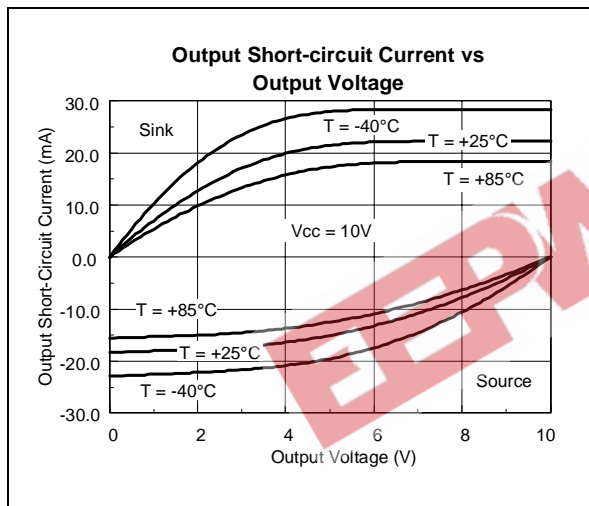

Figure 12:

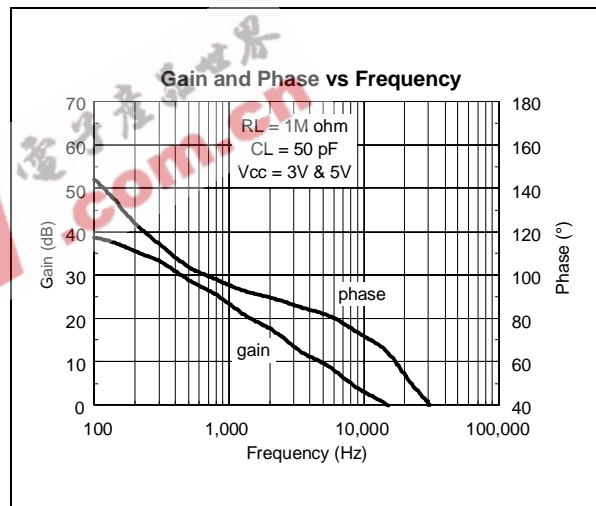

Figure 13:

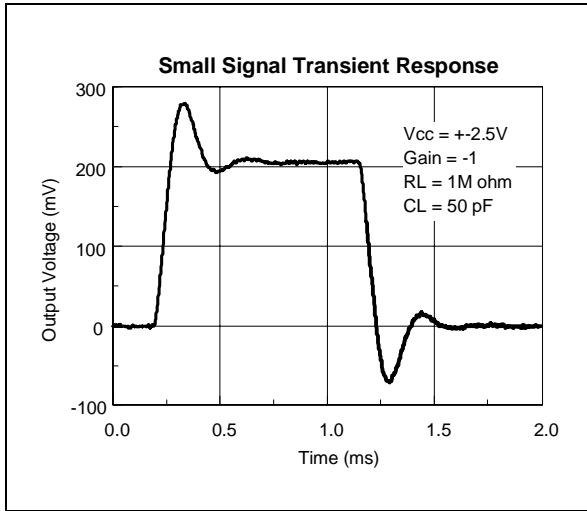

Figure 15:

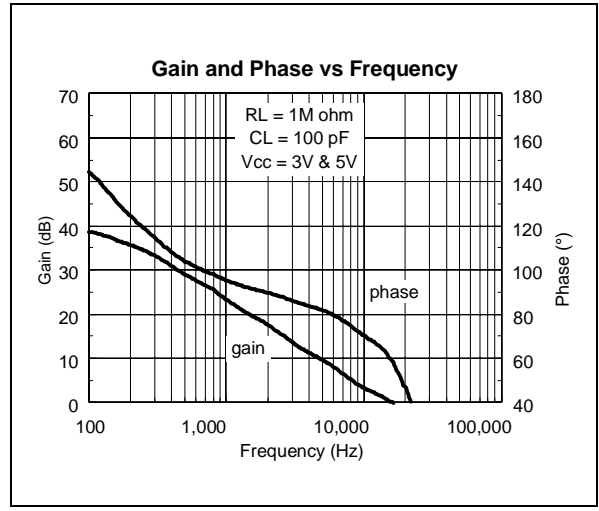

Figure 14:

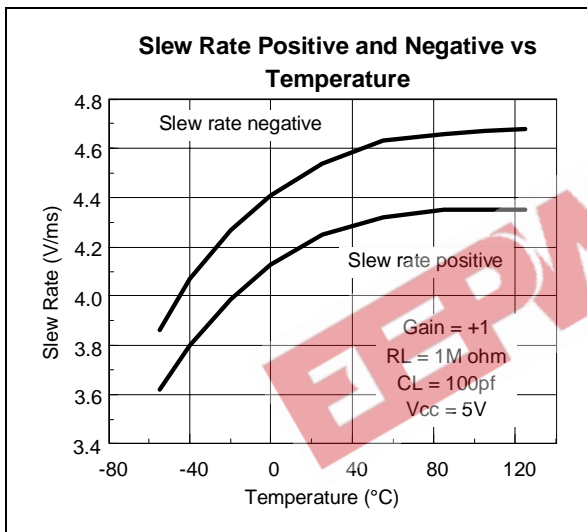
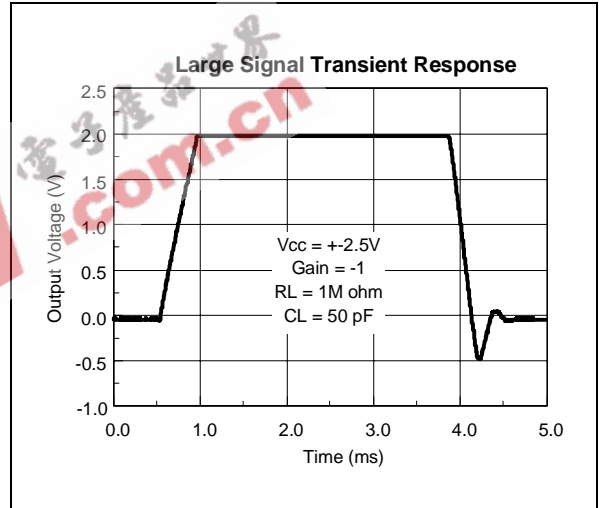

Figure 16:



### 3 Package Mechanical Data

#### 3.1 DIP8 package

**Plastic DIP-8 MECHANICAL DATA**

DIM.	mm.			inch		
	MIN.	TYP	MAX.	MIN.	TYP.	MAX.
A		3.3			0.130	
a1	0.7			0.028		
B	1.39		1.65	0.055		0.065
B1	0.91		1.04	0.036		0.041
b		0.5			0.020	
b1	0.38		0.5	0.015		0.020
D			9.8			0.386
E		8.8			0.346	
e		2.54			0.100	
e3		7.62			0.300	
e4		7.62			0.300	
F			7.1			0.280
I			4.8			0.189
L		3.3			0.130	
Z	0.44		1.6	0.017		0.063

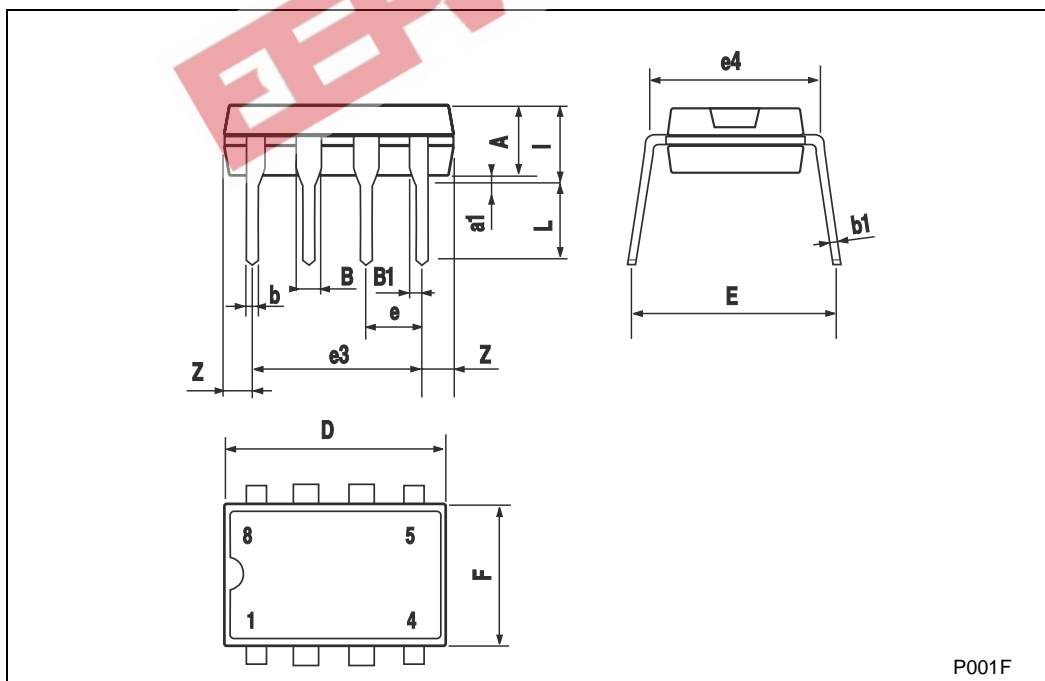

P001F

3.2 SO8 package

**SO-8 MECHANICAL DATA**

DIM.	mm.			inch		
	MIN.	TYP	MAX.	MIN.	TYP.	MAX.
A	1.35		1.75	0.053		0.069
A1	0.10		0.25	0.04		0.010
A2	1.10		1.65	0.043		0.065
B	0.33		0.51	0.013		0.020
C	0.19		0.25	0.007		0.010
D	4.80		5.00	0.189		0.197
E	3.80		4.00	0.150		0.157
e		1.27			0.050	
H	5.80		6.20	0.228		0.244
h	0.25		0.50	0.010		0.020
L	0.40		1.27	0.016		0.050
k	8° (max.)					
ddd			0.1			0.04

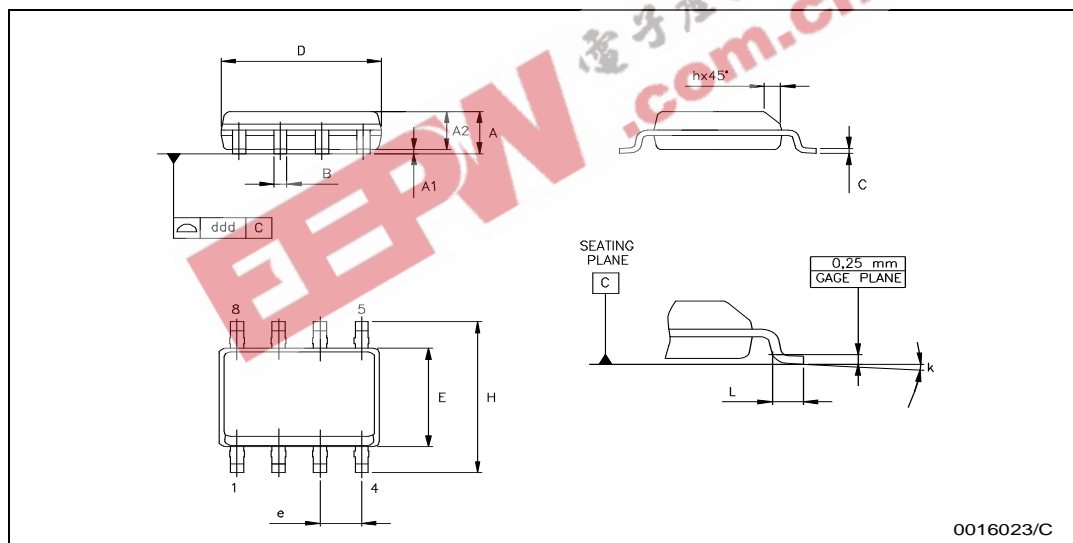

3.3 TSSOP8 package

**TSSOP8 MECHANICAL DATA**

DIM.	mm.			inch		
	MIN.	TYP	MAX.	MIN.	TYP.	MAX.
A			1.2			0.047
A1	0.05		0.15	0.002		0.006
A2	0.80	1.00	1.05	0.031	0.039	0.041
b	0.19		0.30	0.007		0.012
c	0.09		0.20	0.004		0.008
D	2.90	3.00	3.10	0.114	0.118	0.122
E	6.20	6.40	6.60	0.244	0.252	0.260
E1	4.30	4.40	4.50	0.169	0.173	0.177
e		0.65			0.0256	
K	0°		8°	0°		8°
L	0.45	0.60	0.75	0.018	0.024	0.030
L1		1			0.039	

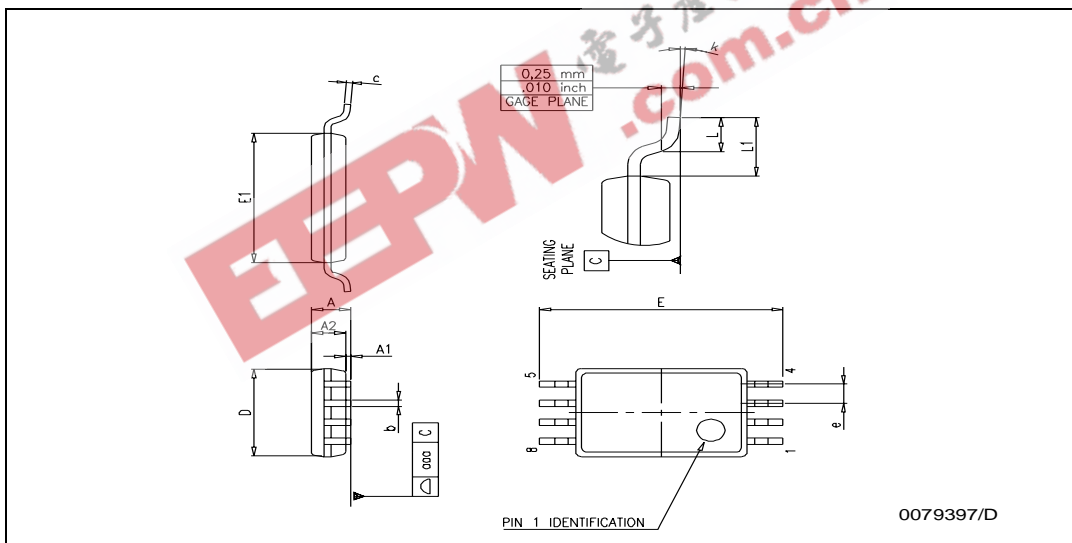

3.4 DIP14 package

**Plastic DIP-14 MECHANICAL DATA**

DIM.	mm.			inch		
	MIN.	TYP	MAX.	MIN.	TYP.	MAX.
a1	0.51			0.020		
B	1.39		1.65	0.055		0.065
b		0.5			0.020	
b1		0.25			0.010	
D			20			0.787
E		8.5			0.335	
e		2.54			0.100	
e3		15.24			0.600	
F			7.1			0.280
I			5.1			0.201
L		3.3			0.130	
Z	1.27		2.54	0.050		0.100

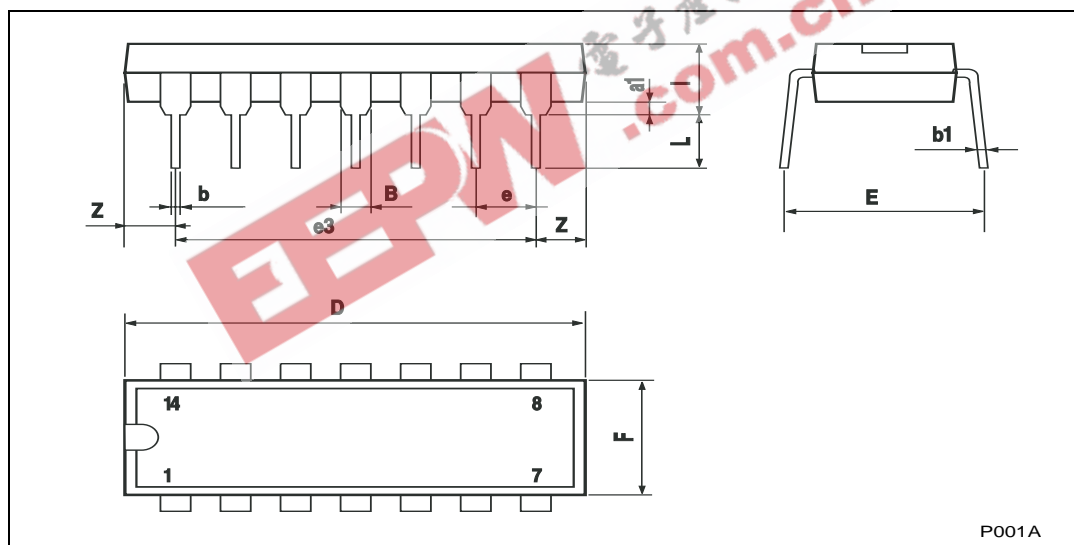

P001A

3.5 SO14 package

**SO-14 MECHANICAL DATA**

DIM.	mm.			inch		
	MIN.	TYP	MAX.	MIN.	TYP.	MAX.
A			1.75			0.068
a1	0.1		0.2	0.003		0.007
a2			1.65			0.064
b	0.35		0.46	0.013		0.018
b1	0.19		0.25	0.007		0.010
C		0.5			0.019	
c1	45° (typ.)					
D	8.55		8.75	0.336		0.344
E	5.8		6.2	0.228		0.244
e		1.27			0.050	
e3		7.62			0.300	
F	3.8		4.0	0.149		0.157
G	4.6		5.3	0.181		0.208
L	0.5		1.27	0.019		0.050
M			0.68			0.026
S	8° (max.)					

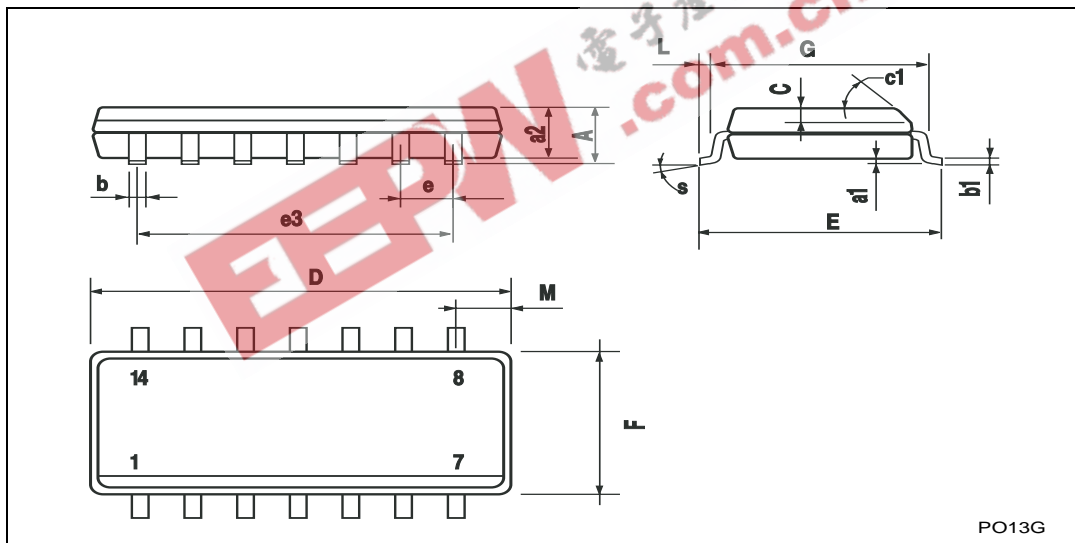

PO13G

3.6 TSSOP14 package

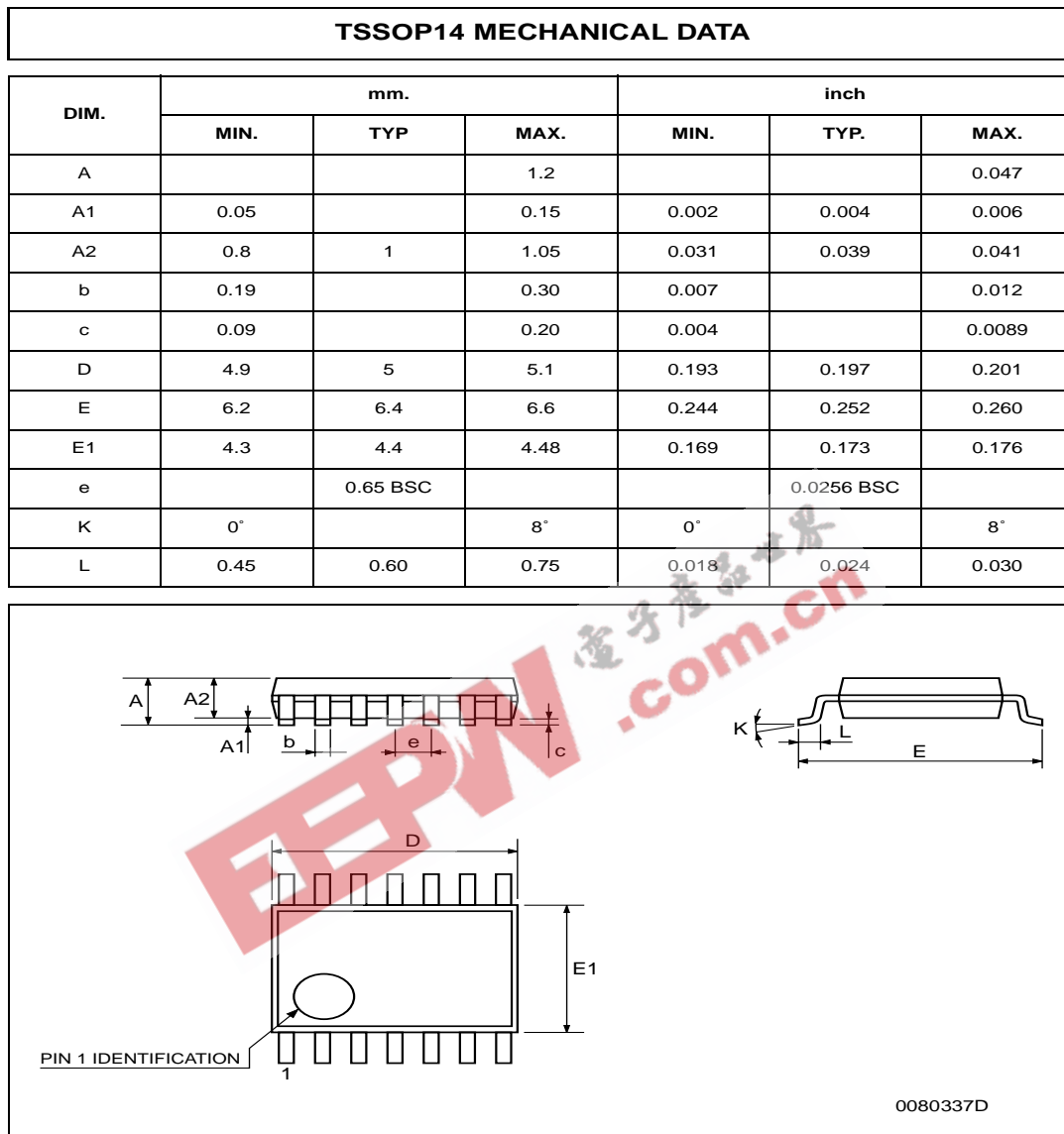



3.7 SOT23-5 package

**SOT23-5L MECHANICAL DATA**

DIM.	mm.			mils		
	MIN.	TYP	MAX.	MIN.	TYP.	MAX.
A	0.90		1.45	35.4		57.1
A1	0.00		0.15	0.0		5.9
A2	0.90		1.30	35.4		51.2
b	0.35		0.50	13.7		19.7
C	0.09		0.20	3.5		7.8
D	2.80		3.00	110.2		118.1
E	2.60		3.00	102.3		118.1
E1	1.50		1.75	59.0		68.8
e		0.95			37.4	
e1		1.9			74.8	
L	0.35		0.55	13.7		21.6

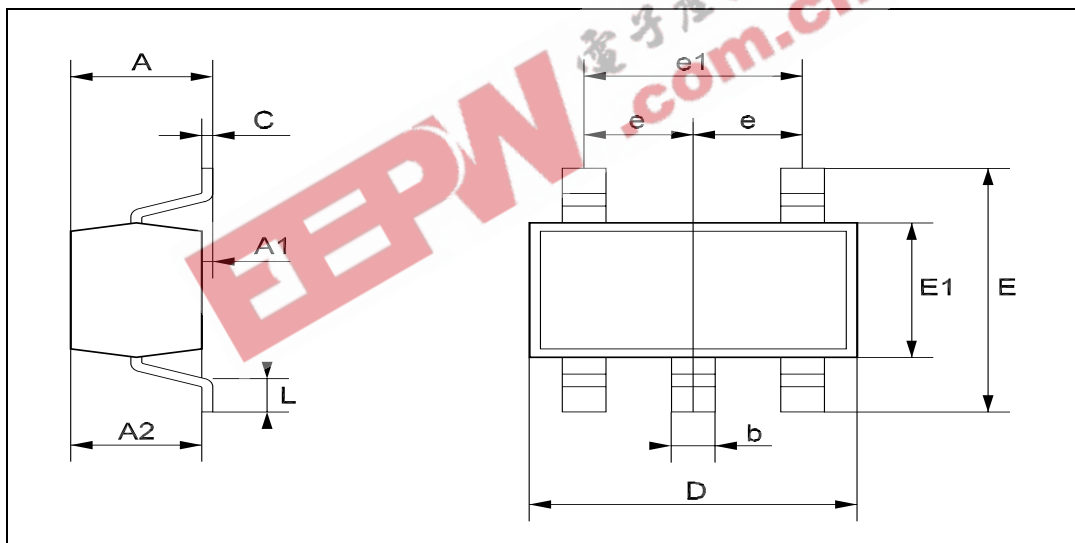

#### 4 Summary of Changes OU

Date	Revision	Description of Changes
01 Dec 2001	1	First Release
01 Dec 2004	2	Modifications on AMR table page 2 (explanation of Vid and Vi limits)

EEPW 电子产品世界  
.com.cn

Information furnished is believed to be accurate and reliable. However, STMicroelectronics assumes no responsibility for the consequences of use of such information nor for any infringement of patents or other rights of third parties which may result from its use. No license is granted by implication or otherwise under any patent or patent rights of STMicroelectronics. Specifications mentioned in this publication are subject to change without notice. This publication supersedes and replaces all information previously supplied. STMicroelectronics products are not authorized for use as critical components in life support devices or systems without express written approval of STMicroelectronics.

The ST logo is a registered trademark of STMicroelectronics  
All other names are the property of their respective owners

© 2004 STMicroelectronics - All rights reserved

STMicroelectronics group of companies

Australia - Belgium - Brazil - Canada - China - Czech Republic - Finland - France - Germany - Hong Kong - India - Israel - Italy - Japan - Malaysia - Malta - Morocco - Singapore - Spain - Sweden - Switzerland - United Kingdom - United States of America

[www.st.com](http://www.st.com)