

30E D ■ 7929237 0031440 3 ■ T:25-15



**SGS-THOMSON**  
MICROELECTRONICS

TXN/TYN 058,G,K → 1008,G,K

S G S-THOMSON

## THYRISTORS

- GLASS PASSIVATED CHIP
- POSSIBILITY OF MOUNTING ON PRINTED CIRCUIT
- AVAILABLE IN NON-INSULATED VERSION → TYN SERIES OR IN INSULATED VERSION → TXN SERIES (INSULATING VOLTAGE 2500 V<sub>RMS</sub>)
- UL RECOGNIZED FOR TXN SERIES (E81734)

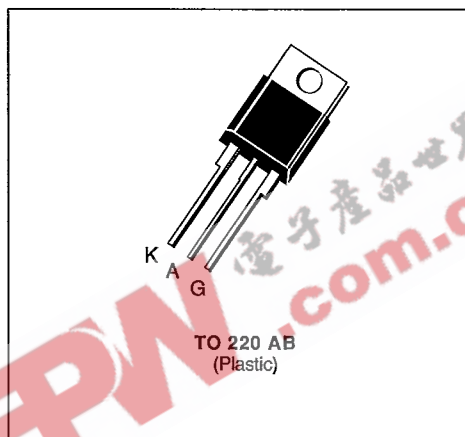

### DESCRIPTION

SCR's designed for motor control, heating controls, power supplies...

### ABSOLUTE RATINGS (limiting values)

Symbol	Parameter	Value	Unit
$I_{T(RMS)}$	RMS on-state Current (1)	$T_c = 75\text{ }^\circ\text{C}$ 8	A
$I_{T(AV)}$	Mean on-state Current (1)	$T_c = 75\text{ }^\circ\text{C}$ 5	A
$I_{TSM}$	Non Repetitive Surge Peak on-state Current ( $T_j$ initial = 25 °C) (2)	$t = 8.3\text{ ms}$	84
		$t = 10\text{ ms}$	80
$I^2t$	$I^2t$ Value for Fusing	$t = 10\text{ ms}$ 32	A <sup>2</sup> s
$di/dt$	Critical Rate of Rise of on-state Current (3)	50	A/ $\mu$ s
$T_{stg}$ $T_j$	Storage and Operating Junction Temperature Range	- 40 to 110	°C
		- 40 to 110	°C

Symbol	Parameter	TXN/TYN ..., G, K							Unit
		058	108	208	408	608	808	1008	
$V_{DRM}$ $V_{RRM}$	Repetitive Peak off-state Voltage (4)	50	100	200	400	600	800	1000	V

(1) Single phase circuit, 180° conduction angle.

(2) Half sine wave.

(3)  $I_G = 400\text{ mA}$   $di/dt = 1\text{ A}/\mu\text{s}$ .

(4)  $T_j = 110\text{ }^\circ\text{C}$ .

### THERMAL RESISTANCES

Symbol	Parameter	Value	Unit
$R_{th(j-c)}$	Junction-case for D.C.	4.7	°C/W
$R_{th(j-a)}$	Junction-air	60	°C/W

TXN/TYN 058,G,K → 1008,G,K S G S-THOMSON

30E D ■ 7929237 0031441 5 ■

T-25-15

**GATE CHARACTERISTICS** (maximum values)

$P_{GM} = 20 \text{ W}$  ( $t_p = 20 \mu\text{s}$ )       $I_{FGM} = 2 \text{ A}$  ( $t_p = 20 \mu\text{s}$ )       $V_{RGM} = 5 \text{ V}$   
 $P_{G(AV)} = 0.5 \text{ W}$        $V_{FGM} = 15 \text{ V}$  ( $t_p = 20 \mu\text{s}$ )

**ELECTRICAL CHARACTERISTICS**

Symbol	Test Conditions	Min.	Typ.	Max.	Unit
$I_{GT}$	$T_j = 25 \text{ }^\circ\text{C}$ $V_D = 12 \text{ V}$ $R_L = 33 \text{ } \Omega$ Pulse Duration > 20 $\mu\text{s}$	Without Suffix		15	mA
		Suffix G		25	
		Suffix K		40	
$V_{GT}$	$T_j = 25 \text{ }^\circ\text{C}$ $V_D = 12 \text{ V}$ $R_L = 33 \text{ } \Omega$ Pulse Duration > 20 $\mu\text{s}$			1.5	V
$V_{GD}$	$T_j = 110 \text{ }^\circ\text{C}$ $V_D = V_{DRM}$ $R_L = 3.3 \text{ k}\Omega$	0.2			V
$I_H$	$T_j = 25 \text{ }^\circ\text{C}$ $I_T = 100 \text{ mA}$ Gate Open	Without Suffix		30	mA
		Suffix G		45	
		Suffix K		60	
$I_L$	$T_j = 25 \text{ }^\circ\text{C}$ $V_D = 12 \text{ V}$ $I_G = 80 \text{ mA}$ Pulse Duration > 20 $\mu\text{s}$		50		mA
$V_{TM}$	$T_j = 25 \text{ }^\circ\text{C}$ $I_{TM} = 16 \text{ A}$ $t_p = 10 \text{ ms}$			1.6	V
$I_{DRM}$	$V_{DRM}$ Specified	$T_j = 25 \text{ }^\circ\text{C}$		0.01	mA
		$T_j = 110 \text{ }^\circ\text{C}$		1	
$I_{RRM}$	$V_{RRM}$ Specified	$T_j = 25 \text{ }^\circ\text{C}$		0.01	mA
		$T_j = 110 \text{ }^\circ\text{C}$		1	
$t_{gt}$	$T_j = 25 \text{ }^\circ\text{C}$ $V_D = V_{DRM}$ $I_G = 40 \text{ mA}$ $di_G/dt = 0.45 \text{ A}/\mu\text{s}$		2		$\mu\text{s}$
$t_q$	$T_j = 110 \text{ }^\circ\text{C}$ $I_T = 16 \text{ A}$ $V_D = 67 \% V_{DRM}$ $di/dt = 30 \text{ A}/\mu\text{s}$ $dv/dt = 50 \text{ V}/\mu\text{s}$		70		$\mu\text{s}$
$dv/dt^*$	$T_j = 110 \text{ }^\circ\text{C}$ Gate Open Linear Slope up to $V_D = 67 \% V_{DRM}$	Without Suffix	200		V/ $\mu\text{s}$
		Suffix G	500		
		Suffix K	750		

\* For higher guaranteed values, please consult us.

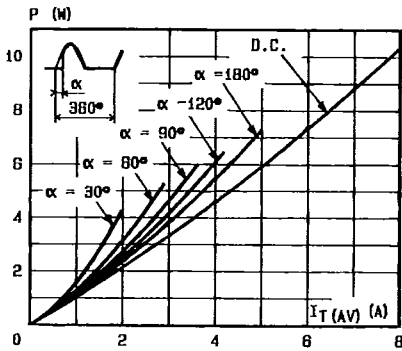

Fig. 1 - Maximum mean power dissipation versus mean on-state current.

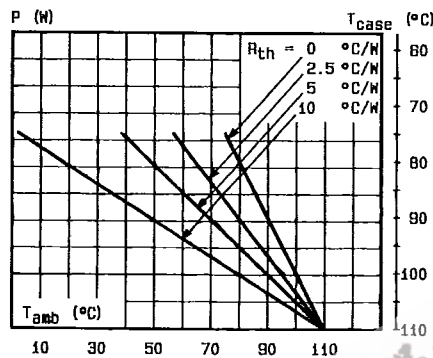

Fig. 2 - Correlation between maximum mean power dissipation and maximum allowable temperatures ( $T_{amb}$  and  $T_{case}$ ) for different thermal resistances heatsink + contact.

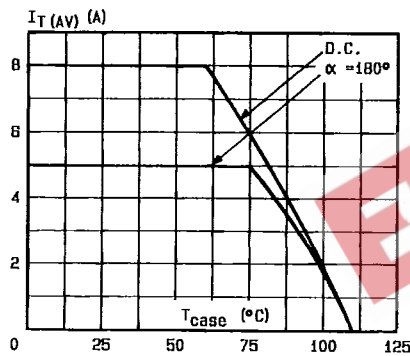

Fig. 3 - Mean on-state current versus case temperature.

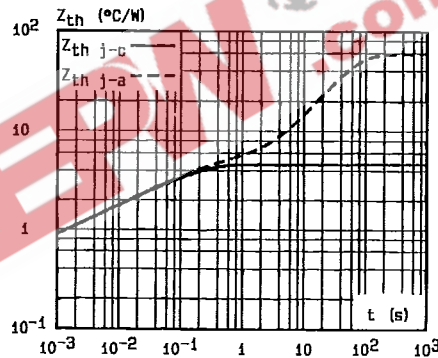

Fig. 4 - Thermal transient impedance junction to case and junction to ambient versus pulse duration.

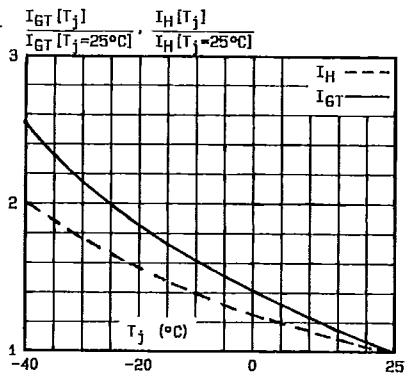

Fig. 5 - Relative variation of gate trigger current and holding current versus junction temperature.

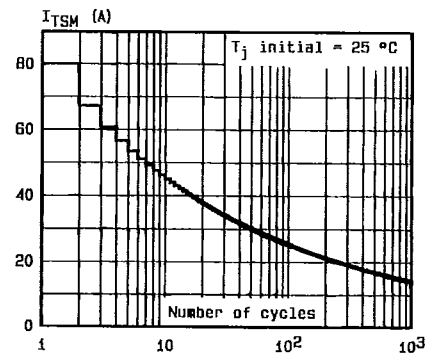

Fig. 6 - Non repetitive surge peak on-state current versus number of cycles.

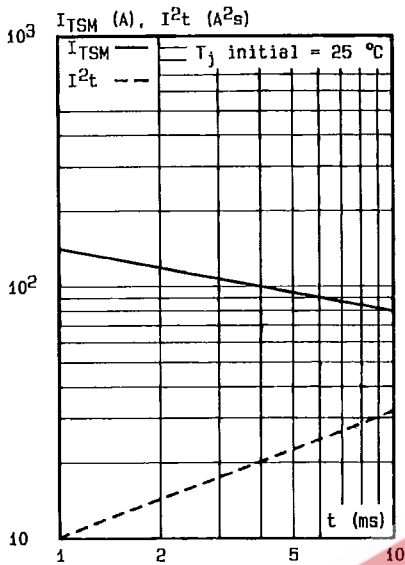

Fig.7 - Non repetitive surge peak on-state current for a sinusoidal pulse with width :  $t \leq 10$  ms, and corresponding value of  $I^2t$ .

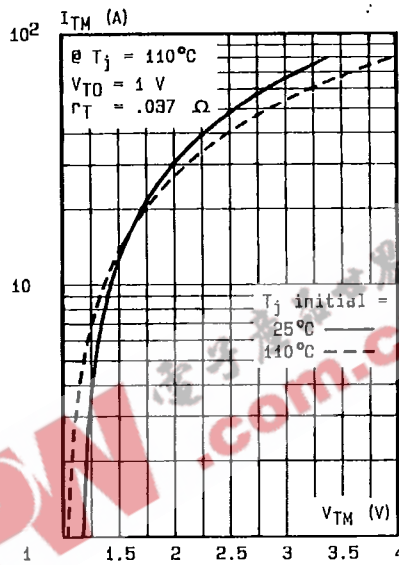
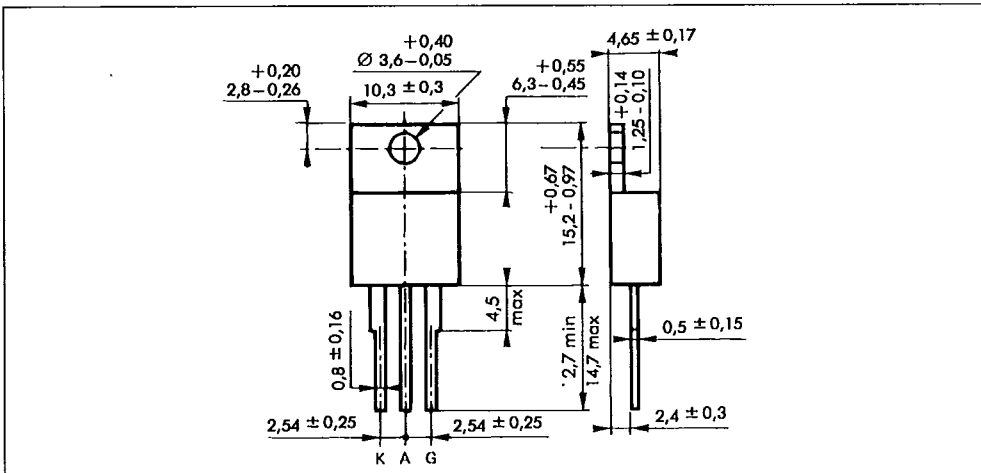

Fig.8 - On-state characteristics (maximum values).

PACKAGE MECHANICAL DATA : TO 220 AB Plastic



Cooling method : by conduction (method C)  
 Marking : type number  
 Weight : 2 g

30E D ■ 7929237 0031443 9 ■