

## Silicon Epitaxial Planar Z-Diodes

### Features

- Very sharp reverse characteristic
- Low reverse current level
- Available with tighter tolerances
- Very high stability
- Low noise



94 9371

### Applications

Voltage stabilization

### Absolute Maximum Ratings

$T_j = 25^\circ\text{C}$

Parameter	Test Conditions	Type	Symbol	Value	Unit
Power dissipation	$R_{thJA} \leq 300\text{K/W}$		$P_V$	500	mW
Z-current			$I_Z$	$P_V/V_Z$	mA
Junction temperature			$T_j$	175	$^\circ\text{C}$
Storage temperature range			$T_{stg}$	-65...+175	$^\circ\text{C}$

### Maximum Thermal Resistance

$T_j = 25^\circ\text{C}$

Parameter	Test Conditions	Symbol	Value	Unit
Junction ambient	on PC board 50mmx50mmx1.6mm	$R_{thJA}$	500	K/W

### Electrical Characteristics

$T_j = 25^\circ\text{C}$

Parameter	Test Conditions	Type	Symbol	Min	Typ	Max	Unit
Forward voltage	$I_F=200\text{mA}$		$V_F$			1.5	V

Type	V <sub>Znom</sub>	I <sub>ZT</sub>	for V <sub>ZT</sub> and	r <sub>zIT</sub>	r <sub>zik</sub> at I <sub>ZK</sub>	I <sub>R</sub> and I <sub>R</sub> at V <sub>R</sub>	TK <sub>VZ</sub>			
TZMC...	V	mA	V <sup>1)</sup>	Ω	Ω	mA	μA	μA <sup>2)</sup>	V	%/K
2V4	2.4	5	2.28 to 2.56	< 85	< 600	1	< 50	< 100	1	-0.09 to -0.06
2V7	2.7	5	2.5 to 2.9	< 85	< 600	1	< 10	< 50	1	-0.09 to -0.06
3V0	3.0	5	2.8 to 3.2	< 90	< 600	1	< 4	< 40	1	-0.08 to -0.05
3V3	3.3	5	3.1 to 3.5	< 90	< 600	1	< 2	< 40	1	-0.08 to -0.05
3V6	3.6	5	3.4 to 3.8	< 90	< 600	1	< 2	< 40	1	-0.08 to -0.05
3V9	3.9	5	3.7 to 4.1	< 90	< 600	1	< 2	< 40	1	-0.08 to -0.05
4V3	4.3	5	4.0 to 4.6	< 90	< 600	1	< 1	< 20	1	-0.06 to -0.03
4V7	4.7	5	4.4 to 5.0	< 80	< 600	1	< 0.5	< 10	1	-0.05 to +0.02
5V1	5.1	5	4.8 to 5.4	< 60	< 550	1	< 0.1	< 2	1	-0.02 to +0.02
5V6	5.6	5	5.2 to 6.0	< 40	< 450	1	< 0.1	< 2	1	-0.05 to +0.05
6V2	6.2	5	5.8 to 6.6	< 10	< 200	1	< 0.1	< 2	2	0.03 to 0.06
6V8	6.8	5	6.4 to 7.2	< 8	< 150	1	< 0.1	< 2	3	0.03 to 0.07
7V5	7.5	5	7.0 to 7.9	< 7	< 50	1	< 0.1	< 2	5	0.03 to 0.07
8V2	8.2	5	7.7 to 8.7	< 7	< 50	1	< 0.1	< 2	6.2	0.03 to 0.08
9V1	9.1	5	8.5 to 9.6	< 10	< 50	1	< 0.1	< 2	6.8	0.03 to 0.09
10	10	5	9.4 to 10.6	< 15	< 70	1	< 0.1	< 2	7.5	0.03 to 0.1
11	11	5	10.4 to 11.6	< 20	< 70	1	< 0.1	< 2	8.2	0.03 to 0.11
12	12	5	11.4 to 12.7	< 20	< 90	1	< 0.1	< 2	9.1	0.03 to 0.11
13	13	5	12.4 to 14.1	< 26	< 110	1	< 0.1	< 2	10	0.03 to 0.11
15	15	5	13.8 to 15.6	< 30	< 110	1	< 0.1	< 2	11	0.03 to 0.11
16	16	5	15.3 to 17.1	< 40	< 170	1	< 0.1	< 2	12	0.03 to 0.11
18	18	5	16.8 to 19.1	< 50	< 170	1	< 0.1	< 2	13	0.03 to 0.11
20	20	5	18.8 to 21.2	< 55	< 220	1	< 0.1	< 2	15	0.03 to 0.11
22	22	5	20.8 to 23.3	< 55	< 220	1	< 0.1	< 2	16	0.04 to 0.12
24	24	5	22.8 to 25.6	< 80	< 220	1	< 0.1	< 2	18	0.04 to 0.12
27	27	5	25.1 to 28.9	< 80	< 220	1	< 0.1	< 2	20	0.04 to 0.12
30	30	5	28 to 32	< 80	< 220	1	< 0.1	< 2	22	0.04 to 0.12
33	33	5	31 to 35	< 80	< 220	1	< 0.1	< 2	24	0.04 to 0.12
36	36	5	34 to 38	< 80	< 220	1	< 0.1	< 2	27	0.04 to 0.12
39	39	2.5	37 to 41	< 90	< 500	0.5	< 0.1	< 5	30	0.04 to 0.12
43	43	2.5	40 to 46	< 90	< 600	0.5	< 0.1	< 5	33	0.04 to 0.12
47	47	2.5	44 to 50	< 110	< 700	0.5	< 0.1	< 5	36	0.04 to 0.12
51	51	2.5	48 to 54	< 125	< 700	0.5	< 0.1	< 10	39	0.04 to 0.12
56	56	2.5	52 to 60	< 135	< 1000	0.5	< 0.1	< 10	43	0.04 to 0.12
62	62	2.5	58 to 66	< 150	< 1000	0.5	< 0.1	< 10	47	0.04 to 0.12
68	68	2.5	64 to 72	< 200	< 1000	0.5	< 0.1	< 10	51	0.04 to 0.12
75	75	2.5	70 to 79	< 250	< 1500	0.5	< 0.1	< 10	56	0.04 to 0.12

1) Tighter tolerances available on request:

TZMA... ± 1% of V<sub>Znom</sub>

TZMB... ± 2% of V<sub>Znom</sub>

TZMF... ± 3% of V<sub>Znom</sub>

2) at T<sub>j</sub> = 150 °C

**Characteristics** ( $T_j = 25^\circ\text{C}$  unless otherwise specified)

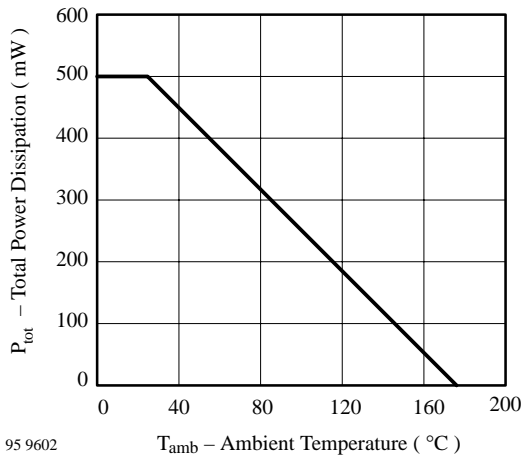

Figure 1. Total Power Dissipation vs. Ambient Temperature

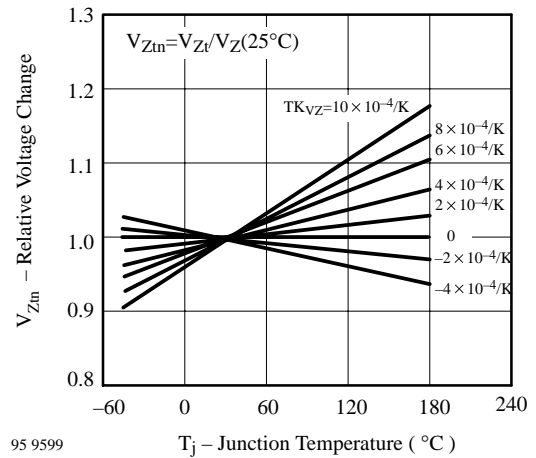

Figure 3. Typical Change of Working Voltage vs. Junction Temperature

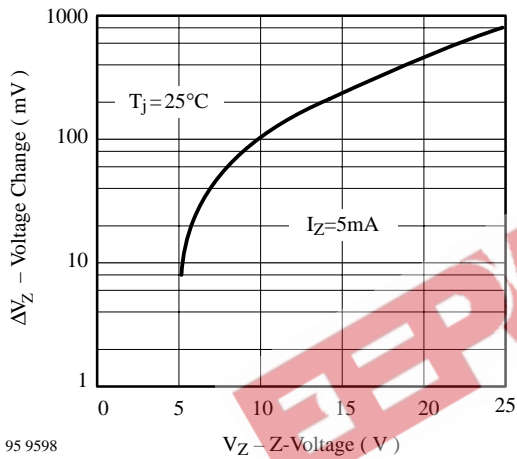

Figure 2. Typical Change of Working Voltage under Operating Conditions at  $T_{amb}=25^\circ\text{C}$

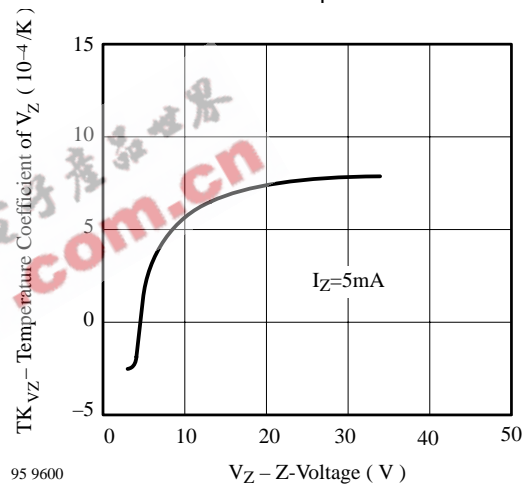

Figure 4. Temperature Coefficient of  $V_Z$  vs. Z-Voltage

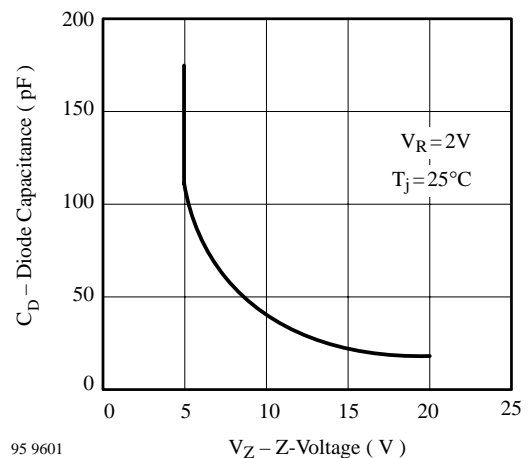

Figure 5. Diode Capacitance vs. Z-Voltage



Figure 6. Forward Current vs. Forward Voltage



Figure 8. Z-Current vs. Z-Voltage



Figure 7. Z-Current vs. Z-Voltage

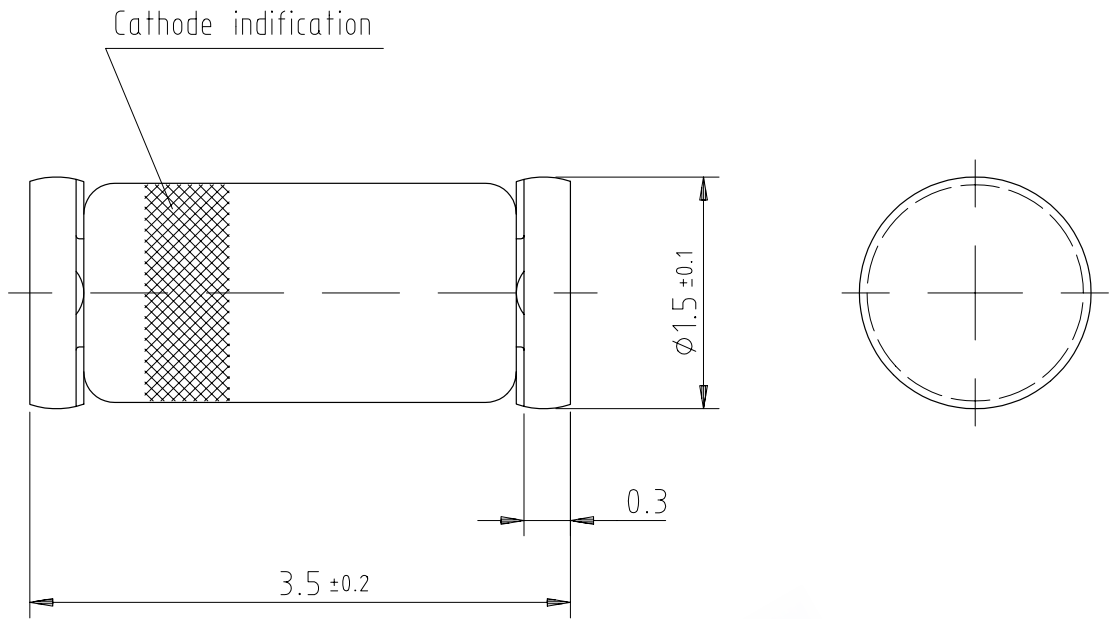

Figure 9. Differential Z-Resistance vs. Z-Voltage

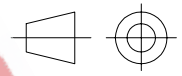

Figure 10. Thermal Response

**Dimensions in mm**



Glass case  
 Mini MELF / SOD 80  
 JEDEC DO 213 AA

  
 technical drawings  
 according to DIN  
 specifications

EPW.com.cn 电子产品世界 9612070

## Ozone Depleting Substances Policy Statement

It is the policy of **Vishay Semiconductor GmbH** to

1. Meet all present and future national and international statutory requirements.
2. Regularly and continuously improve the performance of our products, processes, distribution and operating systems with respect to their impact on the health and safety of our employees and the public, as well as their impact on the environment.

It is particular concern to control or eliminate releases of those substances into the atmosphere which are known as ozone depleting substances (ODSs).

The Montreal Protocol (1987) and its London Amendments (1990) intend to severely restrict the use of ODSs and forbid their use within the next ten years. Various national and international initiatives are pressing for an earlier ban on these substances.

**Vishay Semiconductor GmbH** has been able to use its policy of continuous improvements to eliminate the use of ODSs listed in the following documents.

1. Annex A, B and list of transitional substances of the Montreal Protocol and the London Amendments respectively
2. Class I and II ozone depleting substances in the Clean Air Act Amendments of 1990 by the Environmental Protection Agency (EPA) in the USA
3. Council Decision 88/540/EEC and 91/690/EEC Annex A, B and C (transitional substances) respectively.

**Vishay Semiconductor GmbH** can certify that our semiconductors are not manufactured with ozone depleting substances and do not contain such substances.



**We reserve the right to make changes to improve technical design and may do so without further notice.**

Parameters can vary in different applications. All operating parameters must be validated for each customer application by the customer. Should the buyer use Vishay-Telefunken products for any unintended or unauthorized application, the buyer shall indemnify Vishay-Telefunken against all claims, costs, damages, and expenses, arising out of, directly or indirectly, any claim of personal damage, injury or death associated with such unintended or unauthorized use.

Vishay Semiconductor GmbH, P.O.B. 3535, D-74025 Heilbronn, Germany  
Telephone: 49 (0) 7131 67 2831, Fax number: 49 (0) 7131 67 2423