

ULN2803AP, ULN2803AFW, ULN2804AP, ULN2804AFW

8CH DARLINGTON SINK DRIVER

The ULN2803AP / AFW Series are high-voltage, high-current darlington drivers comprised of eight NPN darlington pairs.

All units feature integral clamp diodes for switching inductive loads.

Applications include relay, hammer, lamp and display (LED) drivers.

FEATURES

- Output current (single output)
500mA (Max.) (ULN2803AP / AFW series)
- High sustaining voltage output
50V (Min.) (ULN2803AP / AFW series)
- Output clamp diodes
- Inputs compatible with various types of logic.
- Package type-AP : DIP-18pin
- Package type-AFW : SOL-18pin

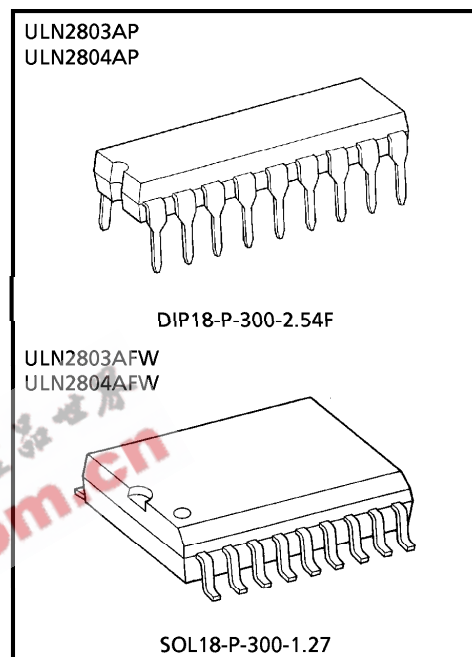

Weight
 DIP18-P-300-2.54F : 1.478g (Typ.)
 SOL18-P-300-1.27 : 0.48g (Typ.)

TYPE	INPUT BASE RESISTOR	DESIGNATION
ULN2803AP / AFW	2.7kΩ	TTL, 5V CMOS
ULN2804AP / AFW	10.5kΩ	6~15V PMOS, CMOS

PIN CONNECTION (TOP VIEW)

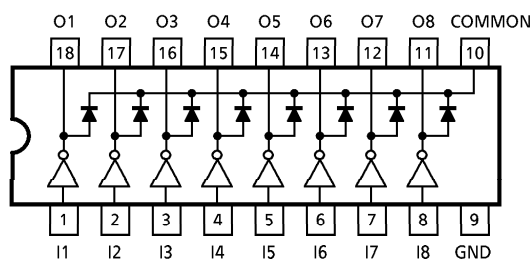

961001EBA1

● TOSHIBA is continually working to improve the quality and the reliability of its products. Nevertheless, semiconductor devices in general can malfunction or fail due to their inherent electrical sensitivity and vulnerability to physical stress. It is the responsibility of the buyer, when utilizing TOSHIBA products, to observe standards of safety, and to avoid situations in which a malfunction or failure of a TOSHIBA product could cause loss of human life, bodily injury or damage to property. In developing your designs, please ensure that TOSHIBA products are used within specified operating ranges as set forth in the most recent products specifications. Also, please keep in mind the precautions and conditions set forth in the TOSHIBA Semiconductor Reliability Handbook.

● The products described in this document are subject to foreign exchange and foreign trade control laws.

● The information contained herein is presented only as a guide for the applications of our products. No responsibility is assumed by TOSHIBA CORPORATION for any infringements of intellectual property or other rights of the third parties which may result from its use. No license is granted by implication or otherwise under any intellectual property or other rights of TOSHIBA CORPORATION or others.

● The information contained herein is subject to change without notice.

SCHEMATICS (EACH DRIVER)

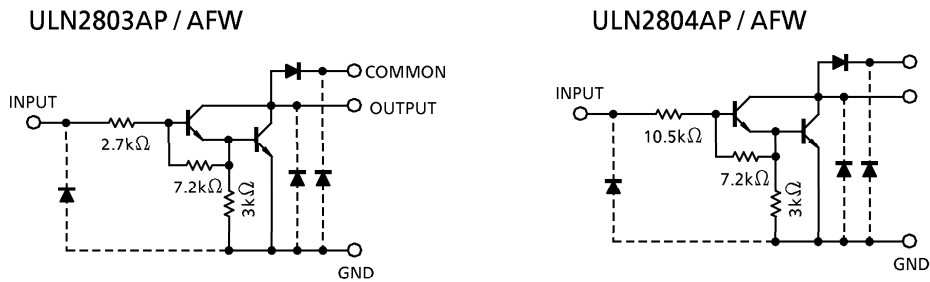

(Note) The input and output parasitic diodes cannot be used as clamp diodes.

MAXIMUM RATINGS (Ta = 25°C)

CHARACTERISTIC		SYMBOL	RATING	UNIT
Output Sustaining Voltage		$V_{CE(SUS)}$	-0.5~50	V
Output Current		I_{OUT}	500	mA / ch
Input Voltage		V_{IN}	-0.5~30	V
Clamp Diode Reverse Voltage		V_R	50	V
Clamp Diode Forward Current		I_F	500	mA
Power Dissipation	AP	P_D	1.47	W
	AFW		0.92 / 1.31 (Note)	
Operating Temperature		T_{opr}	-40~85	°C
Storage Temperature		T_{stg}	-55~150	°C

(Note) On Glass Epoxy PCB (75 x 114 x 1.6mm Cu 20%)

RECOMMENDED OPERATING CONDITIONS (Ta = -40~85°C)

CHARACTERISTIC		SYMBOL	TEST CONDITION	MIN.	TYP.	MAX.	UNIT
Output Sustaining Voltage		V _{CE (SUS)}		0	—	50	V
Output Current	AP	I _{OUT}	T _{pw} = 25ms, Duty = 10%, 8 Circuits	0	—	347	mA / ch
			T _{pw} = 25ms, Duty = 50%, 8 Circuits	0	—	123	
	AFW		T _{pw} = 25ms, Duty = 10%, 8 Circuits	0	—	268	
			T _{pw} = 25ms, Duty = 50%, 8 Circuits	0	—	90	
Input Voltage		V _{IN}		0	—	30	V
Input Voltage (Output On)	ULN2803AP / AFW	V _{IN (ON)}		3.5	—	30	V
	ULN2804AP / AFW			8	—	30	
Clamp Diode Reverse Voltage		V _R		—	—	50	V
Clamp Diode Forward Current		I _F		—	—	400	mA
Power Dissipation	AP	P _D	Ta = 85°C	—	—	0.76	W
	AFW		Ta = 85°C (Note)	—	—	0.48	

(Note) On Glass Epoxy PCB (75×114×1.6mm Cu 20%)

ELECTRICAL CHARACTERISTICS (Ta = 25°C)

CHARACTERISTIC	SYMBOL	TEST CIR-CUIT	TEST CONDITION	MIN.	TYP.	MAX.	UNIT
Output Leakage Current ULN2804AP / AFW	I _{CEX}	1	V _{CE} = 50V, Ta = 25°C	—	—	50	μA
			V _{CE} = 50V, Ta = 85°C	—	—	100	
			V _{CE} = 50V, V _{IN} = 1V	—	—	500	
Collector-Emitter Saturation Voltage	V _{CE (sat)}	2	I _{OUT} = 350mA, I _{IN} = 500μA	—	1.3	1.6	V
			I _{OUT} = 200mA, I _{IN} = 350μA	—	1.1	1.3	
			I _{OUT} = 100mA, I _{IN} = 250μA	—	0.9	1.1	
Input Current ULN2803AP / AFW ULN2804AP / AFW	I _{IN (ON)}	2	V _{IN} = 3.85V	—	0.93	1.35	mA
			V _{IN} = 5V	—	0.35	0.5	
	I _{IN (OFF)}	4	I _{OUT} = 500μA, Ta = 85°C	50	65	—	μA
Input Voltage (Output On) ULN2803AP / AFW ULN2804AP / AFW	V _{IN (ON)}	5	V _{CE} = 2V, I _{OUT} = 200mA	—	—	2.4	V
			V _{CE} = 2V, I _{OUT} = 250mA	—	—	2.7	
			V _{CE} = 2V, I _{OUT} = 300mA	—	—	3.0	
			V _{CE} = 2V, I _{OUT} = 125mA	—	—	5.0	
			V _{CE} = 2V, I _{OUT} = 200mA	—	—	6.0	
			V _{CE} = 2V, I _{OUT} = 275mA	—	—	7.0	
			V _{CE} = 2V, I _{OUT} = 350mA	—	—	8.0	
DC Current Transfer Ratio	h _{FE}	2	V _{CE} = 2V, I _{OUT} = 350mA	1000	—	—	
Clamp Diode Reverse Current	I _R	6	Ta = 25°C (Note)	—	—	50	μA
			Ta = 85°C (Note)	—	—	100	
Clamp Diode Forward Voltage	V _F	7	I _F = 350mA	—	—	2.0	V
Input Capacitance	C _{IN}	—		—	15	—	pF
Turn-On Delay	t _{ON}	8	R _L = 125Ω, V _{OUT} = 50V	—	0.1	—	μs
Turn-Off Delay	t _{OFF}		R _L = 125Ω, V _{OUT} = 50V	—	0.2	—	

(Note) V_R = V_R MAX.

TEST CIRCUIT

1. I_{CEX}

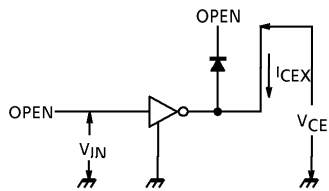

2. $V_{CE(sat)}$, h_{FE}

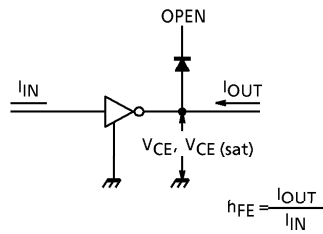

3. $I_{IN(ON)}$

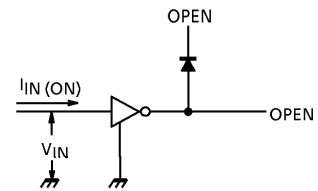

4. $I_{IN(OFF)}$

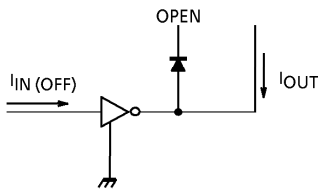

5. $V_{IN(ON)}$

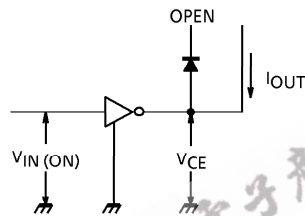

6. I_R

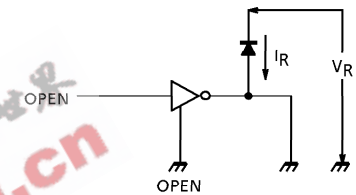

7. V_F

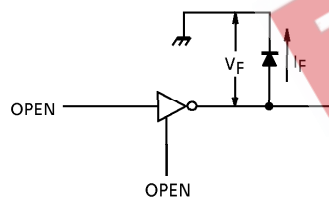

EEPW.com.cn 电子产品世界

8. t_{ON} , t_{OFF}

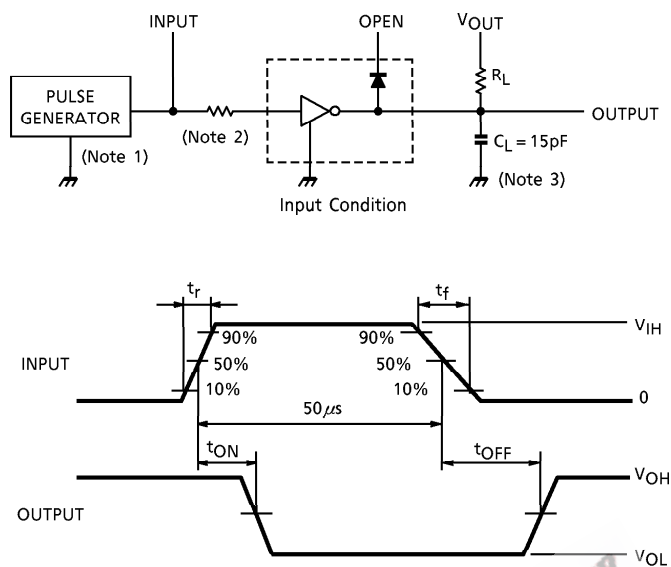

- (Note 1) Pulse Width $50\mu s$, Duty Cycle 10%
Output Impedance 50Ω , $t_r \leq 5ns$, $t_f \leq 10ns$
- (Note 2) See below.

INPUT CONDITION

TYPE NUMBER	R1	V_{IH}
ULN2803AP / AFW	0Ω	3V
ULN2804AP / AFW	0Ω	8V

- (Note 3) C_L includes probe and jig capacitance

PRECAUTIONS for USING

Utmost care is necessary in the design of the output line, COMMON and GND line since IC may be destroyed due to short-circuit between outputs, air contamination fault, or fault by improper grounding.

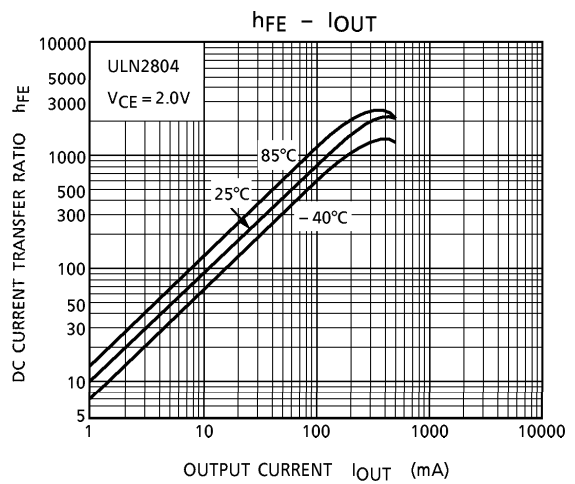
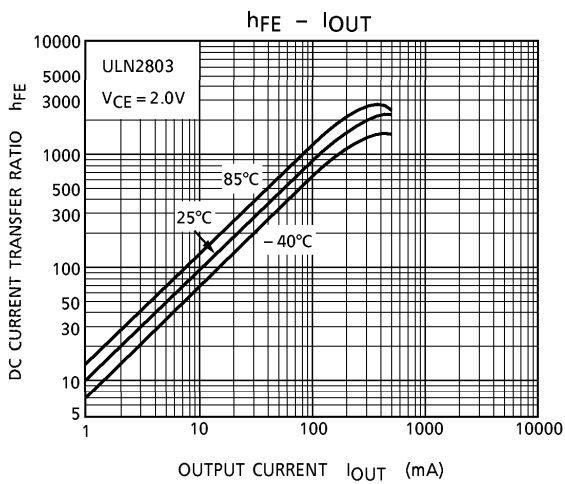
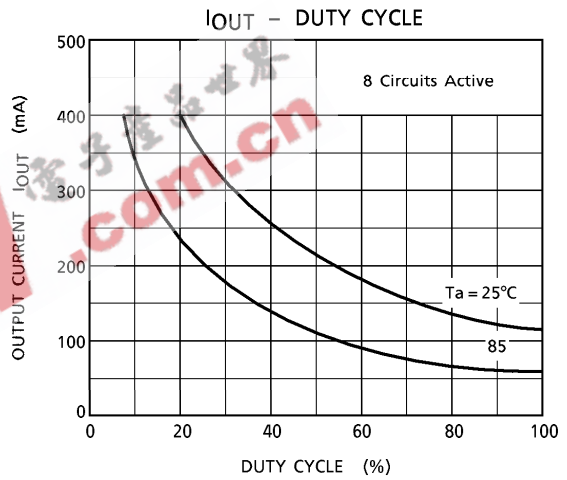
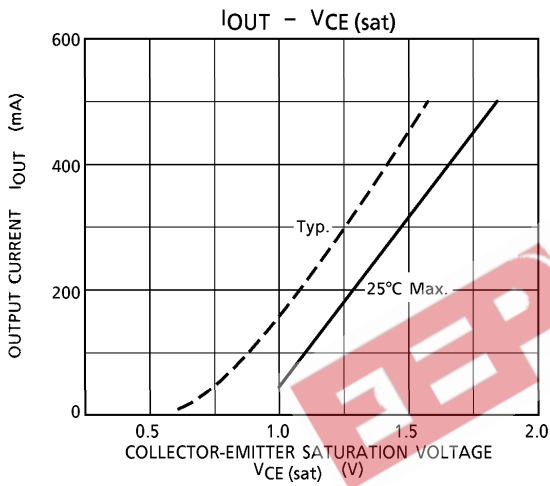
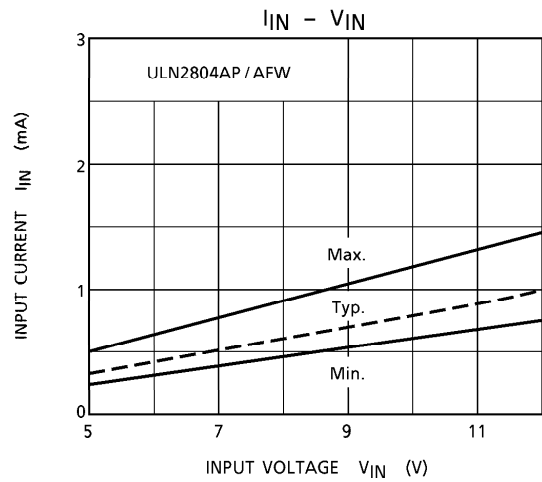
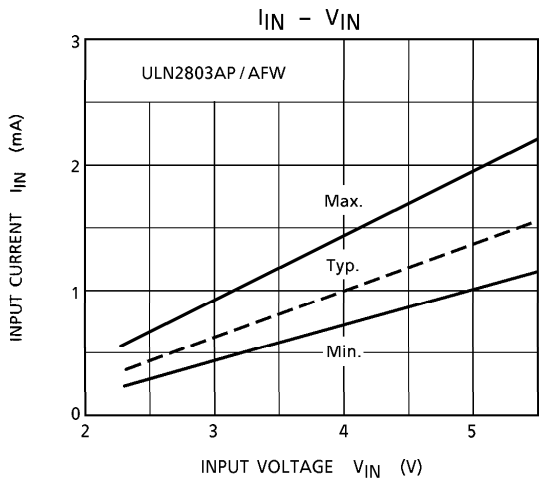

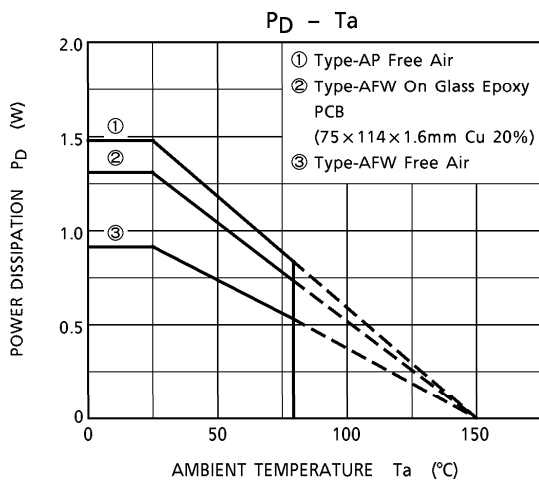

EEPW 电子产品世界 .com.cn

OUTLINE DRAWING
DIP18-P-300-2.54F

Unit : mm

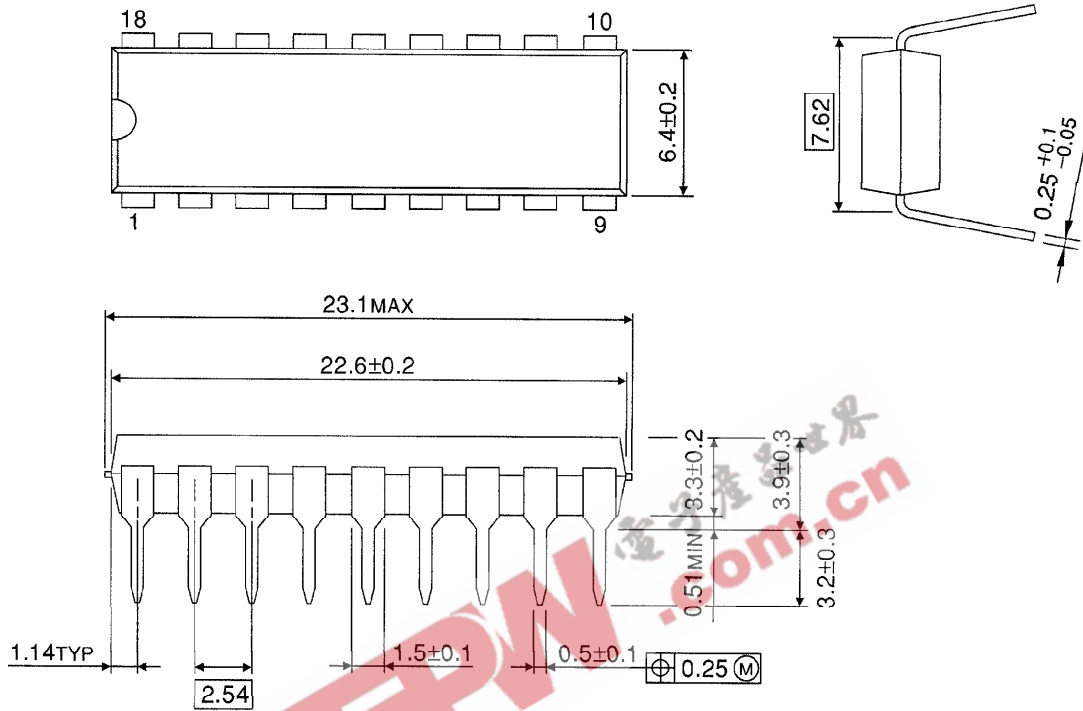

Weight : 1.478g (Typ.)

OUTLINE DRAWING
SOL18-P-300-1.27

Unit : mm

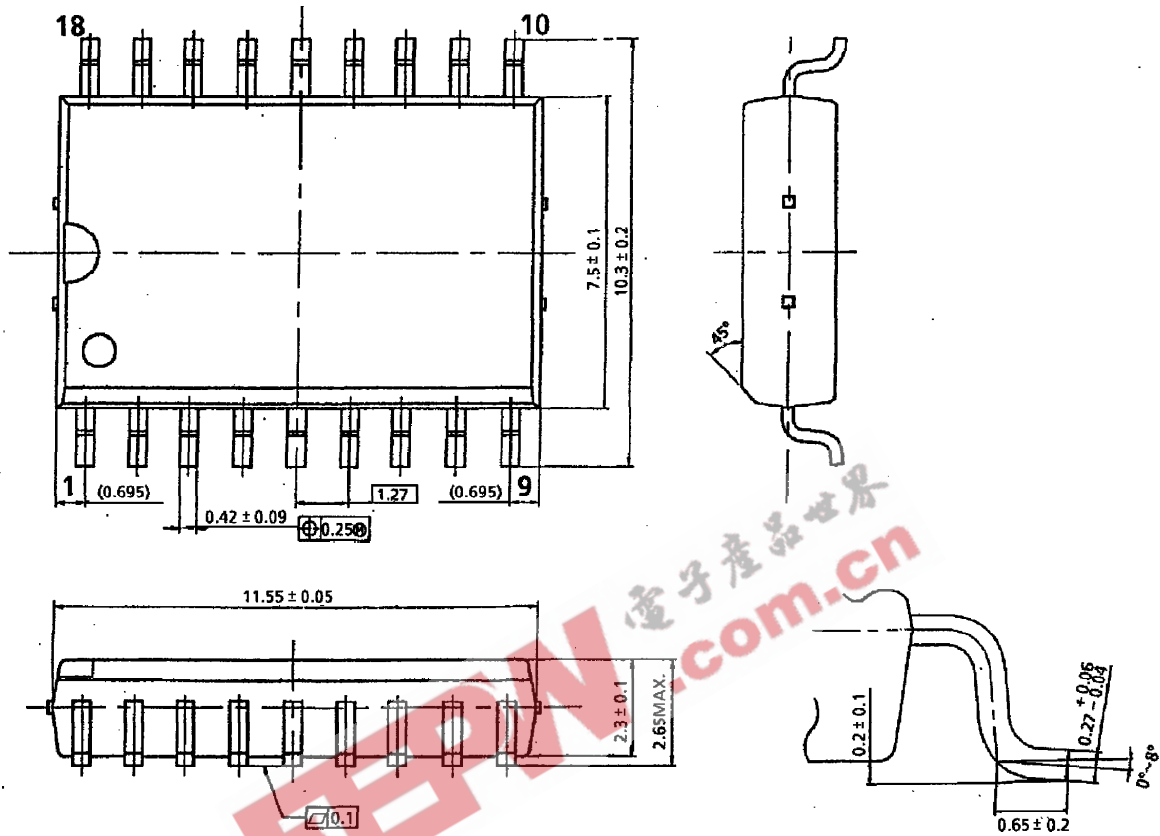

Weight : 0.48g (Typ.)