

## FEATURES

- Dual-Supply Operation . . .  $\pm 5$  V to  $\pm 18$  V
- Low Noise Voltage . . .  $4.5 \text{ nV}/\sqrt{\text{Hz}}$
- Low Input Offset Voltage . . .  $0.15 \text{ mV}$
- Low Total Harmonic Distortion . . .  $0.002\%$
- High Slew Rate . . .  $7 \text{ V}/\mu\text{s}$
- High-Gain Bandwidth Product . . .  $16 \text{ MHz}$
- High Open-Loop AC Gain . . .  $800$  at  $20 \text{ kHz}$
- Large Output-Voltage Swing . . .  $14.1 \text{ V}$  to  $-14.6 \text{ V}$
- Excellent Gain and Phase Margins

D (SOIC), DGK (MSOP), OR P (PDIP) PACKAGE  
(TOP VIEW)

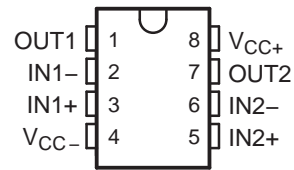

## DESCRIPTION/ORDERING INFORMATION

The MC33078 is a bipolar dual operational amplifier with high-performance specifications for use in quality audio and data-signal applications. This device operates over a wide range of single- and dual-supply voltages and offers low noise, high-gain bandwidth, and high slew rate. Additional features include low total harmonic distortion, excellent phase and gain margins, large output voltage swing with no deadband crossover distortion, and symmetrical sink/source performance.

### ORDERING INFORMATION

$T_A$	PACKAGE <sup>(1)</sup>		ORDERABLE PART NUMBER	TOP-SIDE MARKING <sup>(2)</sup>
-40°C to 85°C	PDIP – P	Tube of 50	MC33078P	MC33078P
	SOIC – D	Tube of 75	MC33078D	M33078
		Reel of 2500	MC33078DR	
	VSSOP/MSOP – DGK	Reel of 2500	MC33078DGKR	MY_
		Reel of 250	MC33078DGKT	

(1) Package drawings, standard packing quantities, thermal data, symbolization, and PCB design guidelines are available at [www.ti.com/sc/package](http://www.ti.com/sc/package).

(2) DGK: The actual top-side marking has one additional character that designates the assembly/test site.

### SYMBOL (EACH AMPLIFIER)

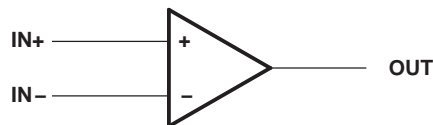

Please be aware that an important notice concerning availability, standard warranty, and use in critical applications of Texas Instruments semiconductor products and disclaimers thereto appears at the end of this data sheet.

### Absolute Maximum Ratings<sup>(1)</sup>

over operating free-air temperature range (unless otherwise noted)

		MIN	MAX	UNIT
V <sub>CC+</sub>	Supply voltage <sup>(2)</sup>		18	V
V <sub>CC-</sub>	Supply voltage <sup>(2)</sup>		-18	V
V <sub>CC+</sub> - V <sub>CC-</sub>	Supply voltage		36	V
	Input voltage, either input <sup>(2)(3)</sup>		V <sub>CC+</sub> or V <sub>CC-</sub>	V
	Input current <sup>(4)</sup>		±10	mA
	Duration of output short circuit <sup>(5)</sup>		Unlimited	
θ <sub>JA</sub>	Package thermal impedance, junction to free air <sup>(6)(7)</sup>	D package	97	°C/W
		DGK package	172	
		P package	85	
T <sub>J</sub>	Operating virtual junction temperature		150	°C
T <sub>stg</sub>	Storage temperature range	-65	150	°C

- (1) Stresses beyond those listed under *Absolute Maximum Ratings* may cause permanent damage to the device. These are stress ratings only, and functional operation of the device at these or any other conditions beyond those indicated under *Recommended Operating Conditions* is not implied. Exposure to absolute-maximum-rated conditions for extended periods may affect device reliability.
- (2) All voltage values, except differential voltages, are with respect to the midpoint between V<sub>CC+</sub> and V<sub>CC-</sub>.
- (3) The magnitude of the input voltage must never exceed the magnitude of the supply voltage.
- (4) Excessive input current will flow if a differential input voltage in excess of approximately 0.6 V is applied between the inputs, unless some limiting resistance is used.
- (5) The output may be shorted to ground or either power supply. Temperature and/or supply voltages must be limited to ensure the maximum dissipation rating is not exceeded.
- (6) Maximum power dissipation is a function of T<sub>J(max)</sub>, θ<sub>JA</sub>, and T<sub>A</sub>. The maximum allowable power dissipation at any allowable ambient temperature is P<sub>D</sub> = (T<sub>J(max)</sub> - T<sub>A</sub>)/θ<sub>JA</sub>. Operating at the absolute maximum T<sub>J</sub> of 150°C can affect reliability.
- (7) The package thermal impedance is calculated in accordance with JESD 51-7.

### Recommended Operating Conditions

		MIN	MAX	UNIT
V <sub>CC-</sub>	Supply voltage	-5	-18	V
V <sub>CC+</sub>		5	18	
T <sub>A</sub>	Operating free-air temperature range	-40	85	°C

### Electrical Characteristics

$V_{CC-} = -15\text{ V}$ ,  $V_{CC+} = 15\text{ V}$ ,  $T_A = 25^\circ\text{C}$  (unless otherwise noted)

PARAMETER		TEST CONDITIONS		MIN	TYP	MAX	UNIT
$V_{IO}$	Input offset voltage	$V_O = 0$ , $R_S = 10\ \Omega$ , $V_{CM} = 0$	$T_A = 25^\circ\text{C}$	0.15	2		mV
			$T_A = -40^\circ\text{C}$ to $85^\circ\text{C}$			3	
$\alpha V_{IO}$	Input offset voltage temperature coefficient	$V_O = 0$ , $R_S = 10\ \Omega$ , $V_{CM} = 0$	$T_A = -40^\circ\text{C}$ to $85^\circ\text{C}$		2		$\mu\text{V}/^\circ\text{C}$
$I_{IB}$	Input bias current	$V_O = 0$ , $V_{CM} = 0$	$T_A = 25^\circ\text{C}$		300	750	nA
			$T_A = -40^\circ\text{C}$ to $85^\circ\text{C}$			800	
$I_{IO}$	Input offset current	$V_O = 0$ , $V_{CM} = 0$	$T_A = 25^\circ\text{C}$		25	150	nA
			$T_A = -40^\circ\text{C}$ to $85^\circ\text{C}$			175	
$V_{ICR}$	Common-mode input voltage range	$\Delta V_{IO} = 5\text{ mV}$ , $V_O = 0$		$\pm 13$	$\pm 14$		V
$A_{VD}$	Large-signal differential voltage amplification	$R_L \geq 2\text{ k}\Omega$ , $V_O = \pm 10\text{ V}$	$T_A = 25^\circ\text{C}$	90	110		dB
			$T_A = -40^\circ\text{C}$ to $85^\circ\text{C}$	85			
$V_{OM}$	Maximum output voltage swing	$V_{ID} = \pm 1\text{ V}$	$R_L = 600\ \Omega$	$V_{OM+}$		10.7	V
				$V_{OM-}$		-11.9	
			$R_L = 2\text{ k}\Omega$	$V_{OM+}$	13.2	13.8	
				$V_{OM-}$	-13.2	-13.7	
			$R_L = 10\text{ k}\Omega$	$V_{OM+}$	13.5	14.1	
				$V_{OM-}$	-14	-14.6	
CMMR	Common-mode rejection ratio	$V_{IN} = \pm 13\text{ V}$		80	100		dB
$k_{SVR}^{(1)}$	Supply-voltage rejection ratio	$V_{CC+} = 5\text{ V}$ to $15\text{ V}$ , $V_{CC-} = -5\text{ V}$ to $-15\text{ V}$		80	105		dB
$I_{OS}$	Output short-circuit current	$ V_{ID}  = 1\text{ V}$ , Output to GND	Source current	15	29		mA
			Sink current	-20	-37		
$I_{CC}$	Supply current (per channel)	$V_O = 0$	$T_A = 25^\circ\text{C}$		2.05	2.5	mA
			$T_A = -40^\circ\text{C}$ to $85^\circ\text{C}$			2.75	

(1) Measured with  $V_{CC\pm}$  differentially varied at the same time

### Operating Characteristics

$V_{CC-} = -15\text{ V}$ ,  $V_{CC+} = 15\text{ V}$ ,  $T_A = 25^\circ\text{C}$  (unless otherwise noted)

PARAMETER		TEST CONDITIONS		MIN	TYP	MAX	UNIT
SR	Slew rate at unity gain	$A_{VD} = 1$ , $V_{IN} = -10\text{ V}$ to $10\text{ V}$ , $R_L = 2\text{ k}\Omega$ , $C_L = 100\text{ pF}$		5	7		V/ $\mu\text{s}$
GBW	Gain bandwidth product	$f = 100\text{ kHz}$		10	16		MHz
$B_1$	Unity gain frequency	Open loop			9		MHz
$G_m$	Gain margin	$R_L = 2\text{ k}\Omega$	$C_L = 0\text{ pF}$		-11		dB
			$C_L = 100\text{ pF}$		-6		
$\Phi_m$	Phase margin	$R_L = 2\text{ k}\Omega$	$C_L = 0\text{ pF}$		55		deg
			$C_L = 100\text{ pF}$		40		
	Amp-to-amp isolation	$f = 20\text{ Hz}$ to $20\text{ kHz}$			-120		dB
	Power bandwidth	$V_O = 27\text{ V}_{(PP)}$ , $R_L = 2\text{ k}\Omega$ , $\text{THD} \leq 1\%$			120		kHz
THD	Total harmonic distortion	$V_O = 3\text{ V}_{rms}$ , $A_{VD} = 1$ , $R_L = 2\text{ k}\Omega$ , $f = 20\text{ Hz}$ to $20\text{ kHz}$			0.002		%
$Z_o$	Open-loop output impedance	$V_O = 0$ , $f = 9\text{ MHz}$			37		$\Omega$
$r_{id}$	Differential input resistance	$V_{CM} = 0$			175		k $\Omega$
$C_{id}$	Differential input capacitance	$V_{CM} = 0$			12		pF
$V_n$	Equivalent input noise voltage	$f = 1\text{ kHz}$ , $R_S = 100\ \Omega$			4.5		nV/ $\sqrt{\text{Hz}}$
$I_n$	Equivalent input noise current	$f = 1\text{ kHz}$			0.5		pA/ $\sqrt{\text{Hz}}$

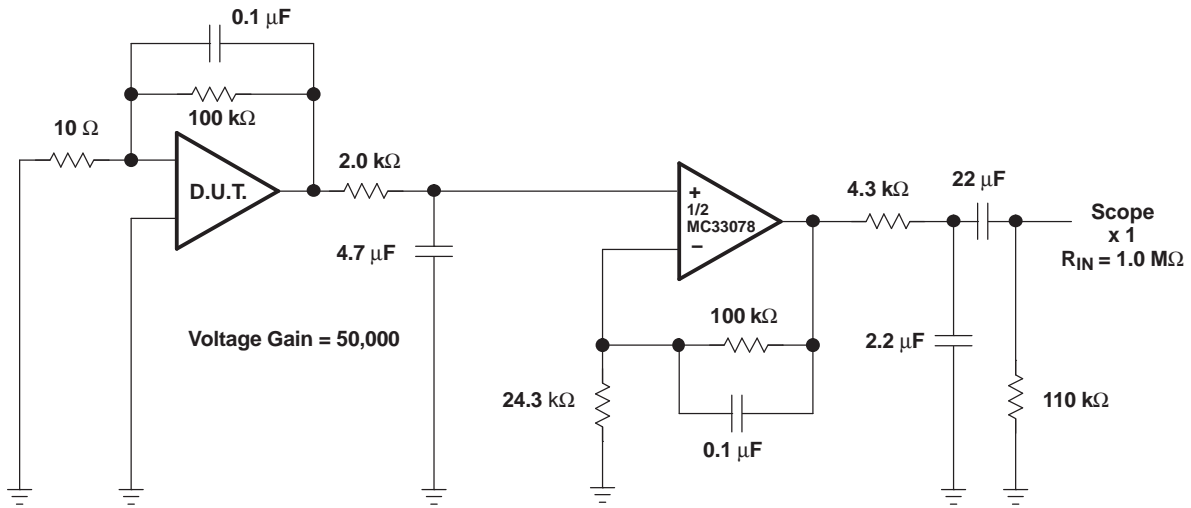

NOTE: All capacitors are non-polarized.

Figure 1. Voltage Noise Test Circuit (0.1 Hz to 10 Hz)

**TYPICAL CHARACTERISTICS**

**INPUT BIAS CURRENT**  
 VS  
**COMMON-MODE VOLTAGE**

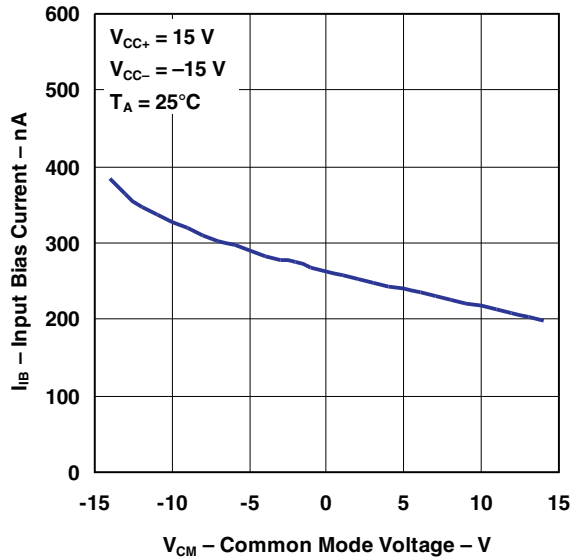

**INPUT BIAS CURRENT**  
 VS  
**SUPPLY VOLTAGE**

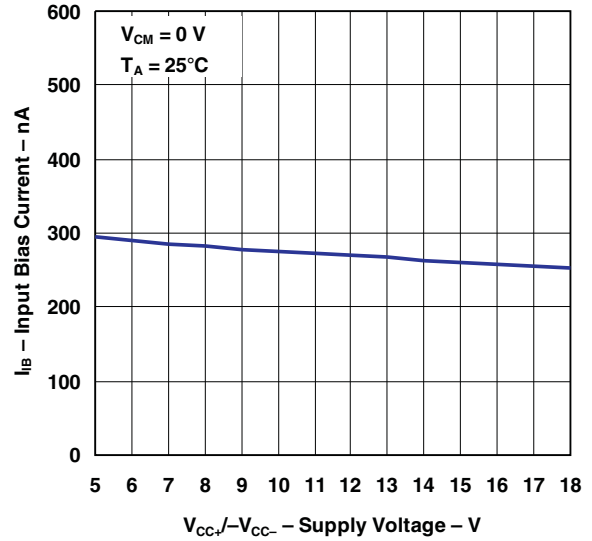

**INPUT BIAS CURRENT**  
 VS  
**TEMPERATURE**

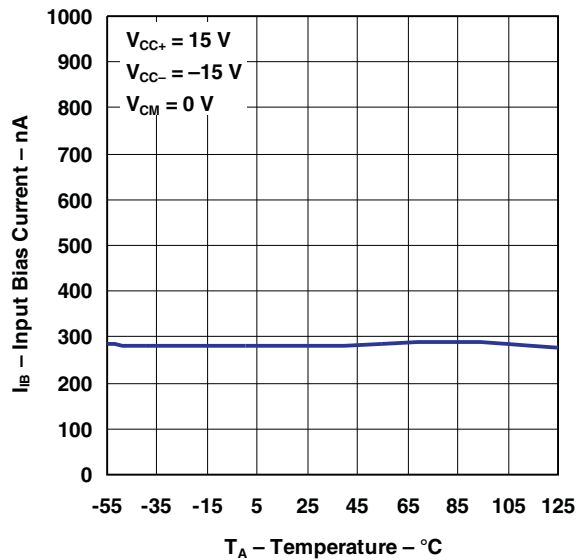

**INPUT OFFSET VOLTAGE**  
 VS  
**TEMPERATURE**

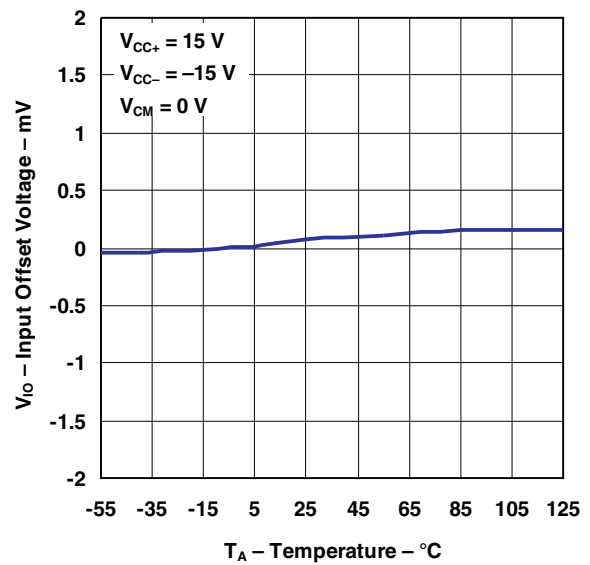

TYPICAL CHARACTERISTICS (continued)

INPUT COMMON-MODE VOLTAGE  
 LOW PROXIMITY TO  $V_{CC-}$   
 VS  
 TEMPERATURE

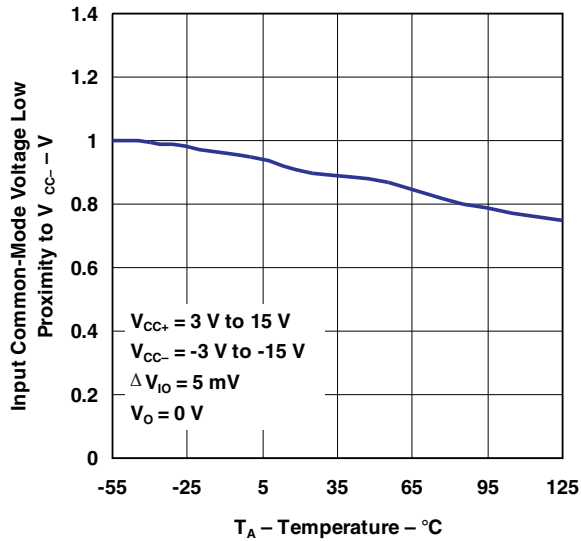

INPUT COMMON-MODE VOLTAGE  
 HIGH PROXIMITY TO  $V_{CC+}$   
 VS  
 TEMPERATURE

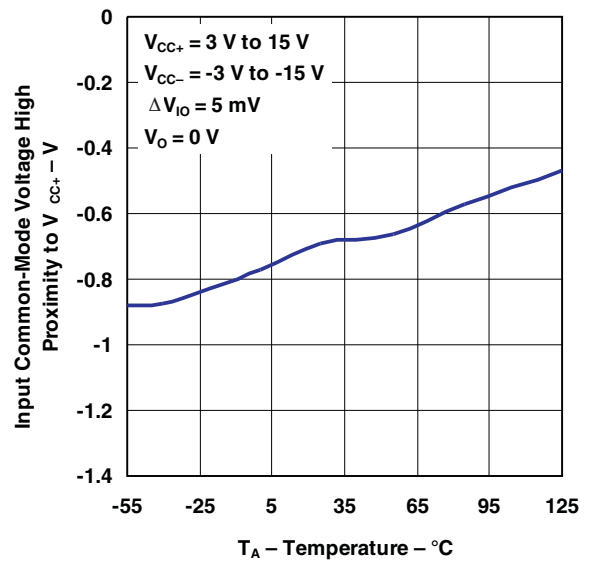

OUTPUT SATURATION VOLTAGE PROXIMITY TO  $V_{CC+}$   
 VS  
 LOAD RESISTANCE

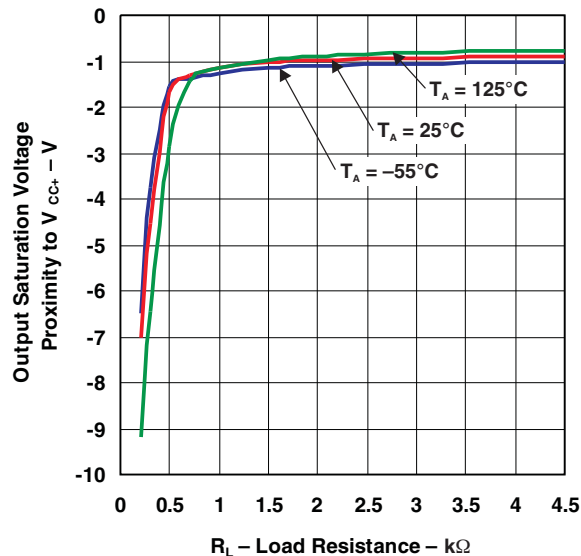

OUTPUT SATURATION VOLTAGE PROXIMITY TO  $V_{CC-}$   
 VS  
 LOAD RESISTANCE

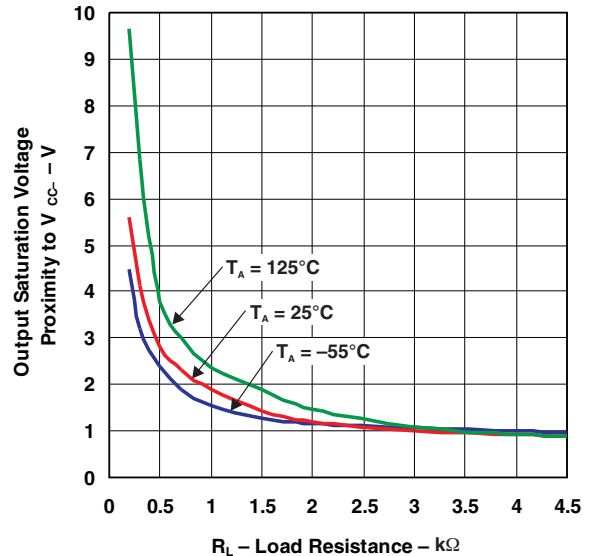

**TYPICAL CHARACTERISTICS (continued)**

**OUTPUT SHORT-CIRCUIT CURRENT  
VS  
TEMPERATURE**

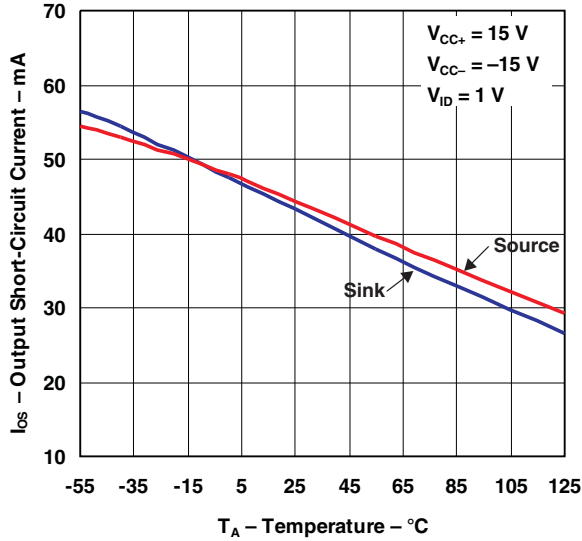

**SUPPLY CURRENT  
VS  
TEMPERATURE**

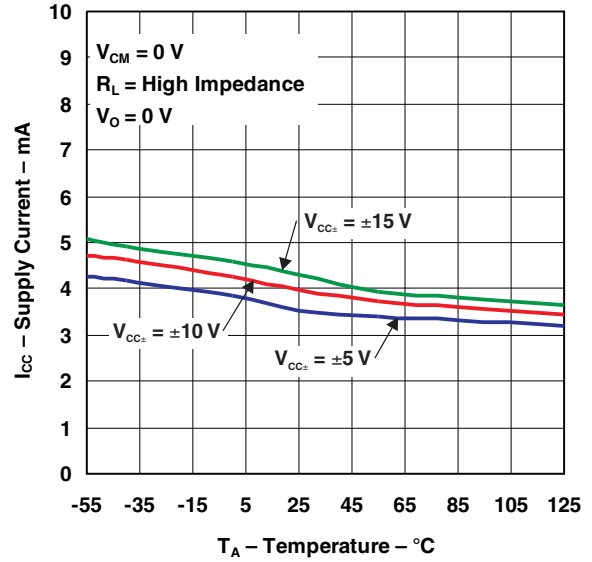

**CMRR  
VS  
FREQUENCY**

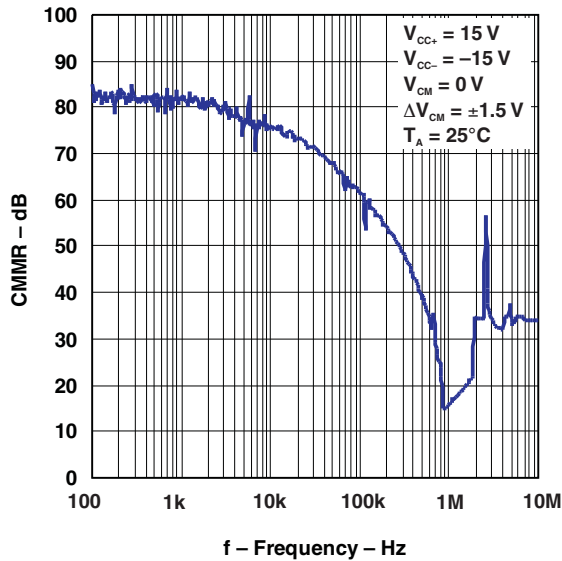

**PSSR  
VS  
FREQUENCY**

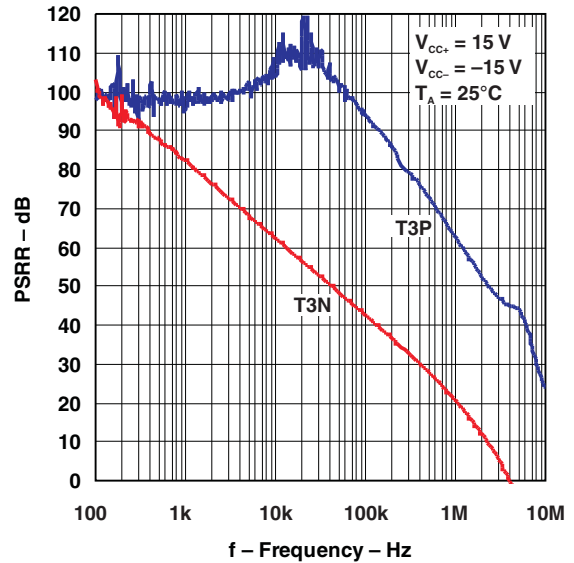

TYPICAL CHARACTERISTICS (continued)

GAIN BANDWIDTH PRODUCT  
 VS  
 SUPPLY VOLTAGE

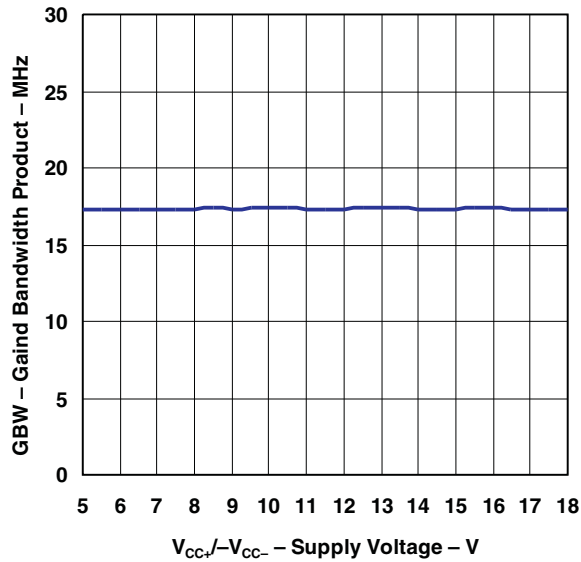

GAIN BANDWIDTH PRODUCT  
 VS  
 TEMPERATURE

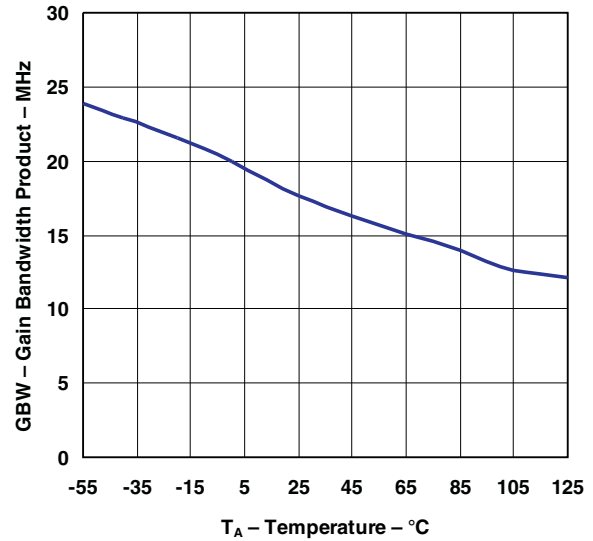

OUTPUT VOLTAGE  
 VS  
 SUPPLY VOLTAGE

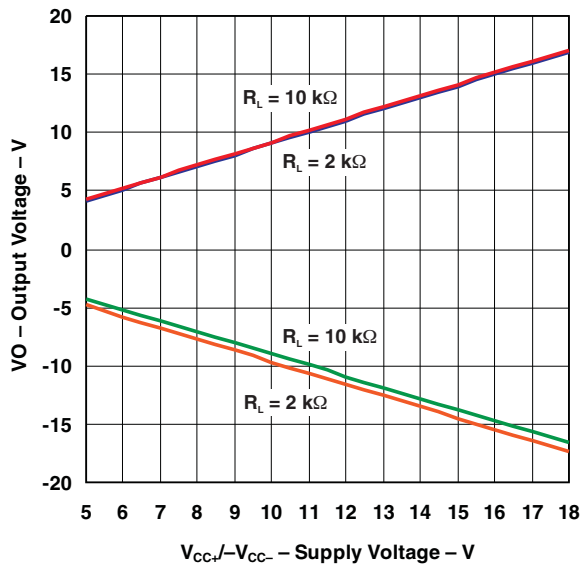

OUTPUT VOLTAGE  
 VS  
 FREQUENCY

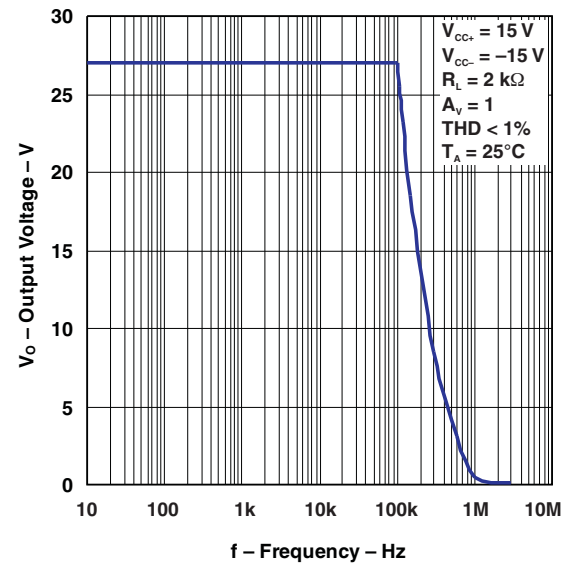



**TYPICAL CHARACTERISTICS (continued)**

**OPEN-LOOP GAIN  
VS  
SUPPLY VOLTAGE**

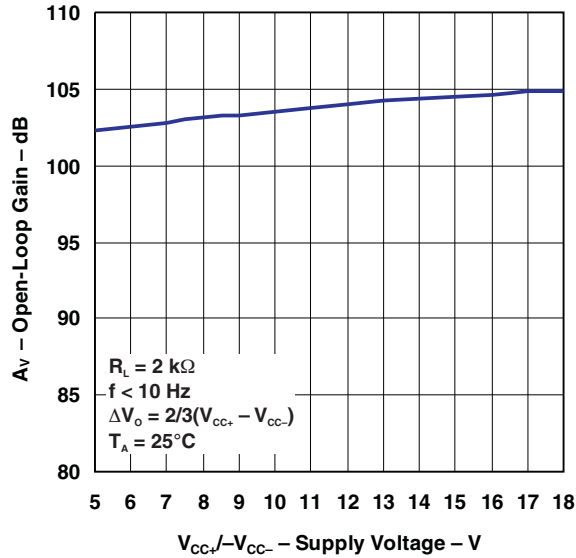

**OPEN-LOOP GAIN  
VS  
TEMPERATURE**

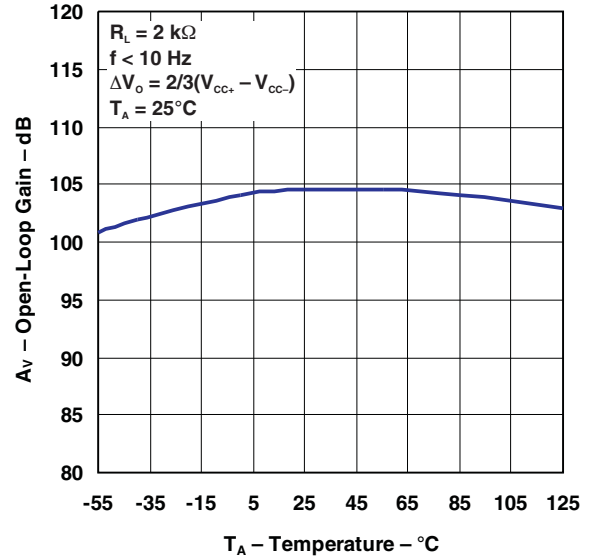

**OUTPUT IMPEDANCE  
VS  
FREQUENCY**

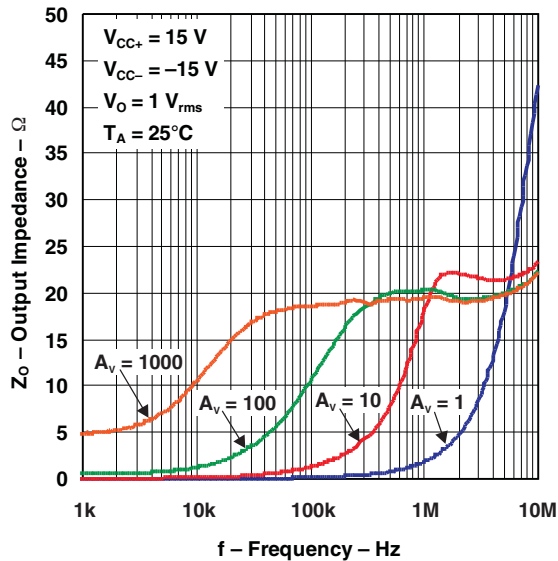

**CROSSTALK REJECTION  
VS  
FREQUENCY**

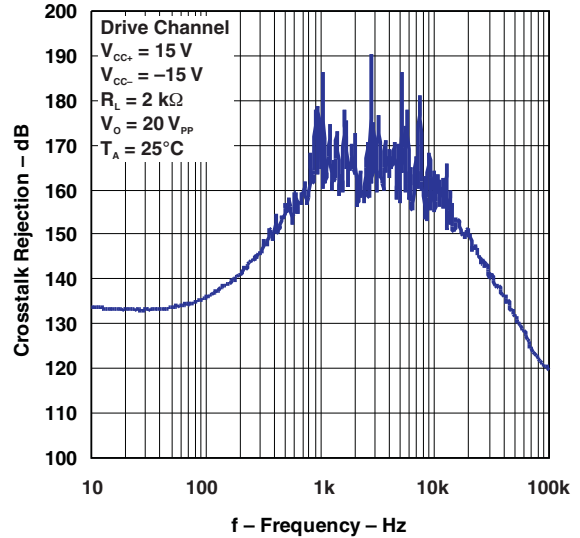

TYPICAL CHARACTERISTICS (continued)

TOTAL HARMONIC DISTORTION  
 VS  
 FREQUENCY

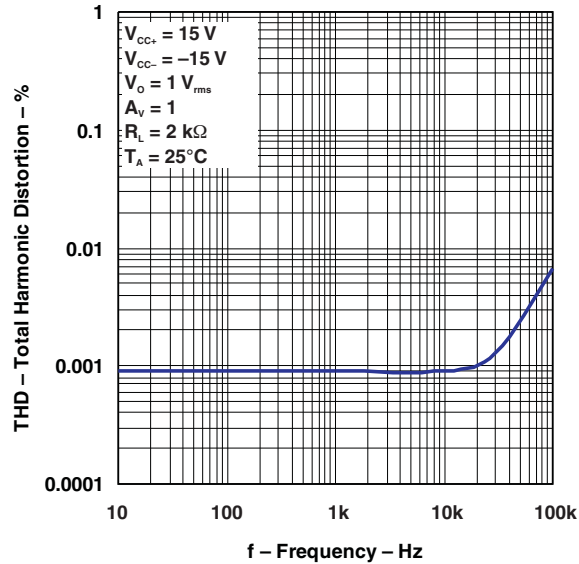

TOTAL HARMONIC DISTORTION  
 VS  
 OUTPUT VOLTAGE

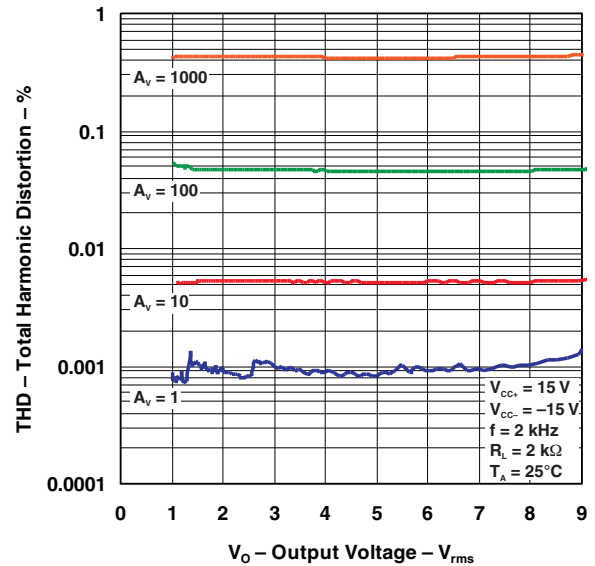

SLEW RATE  
 VS  
 SUPPLY VOLTAGE

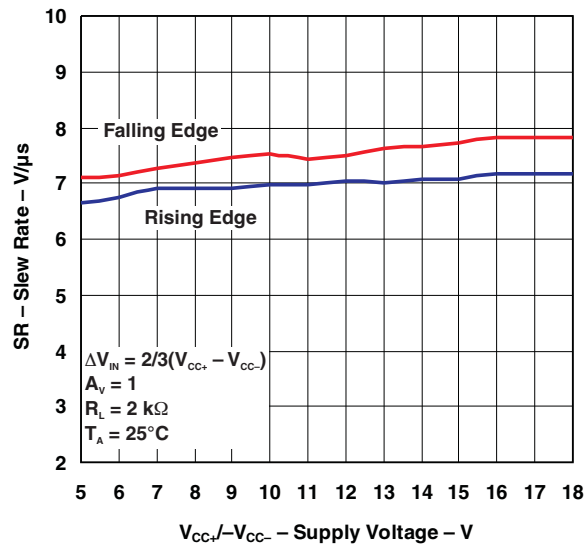

SLEW RATE  
 VS  
 TEMPERATURE

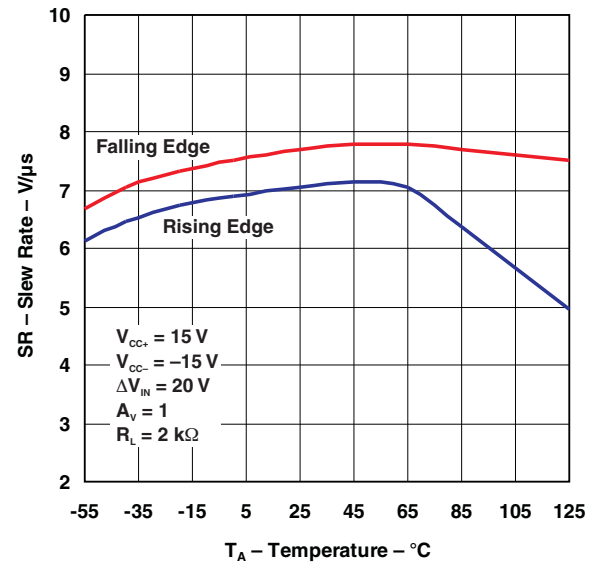

**TYPICAL CHARACTERISTICS (continued)**

**GAIN AND PHASE VS FREQUENCY**

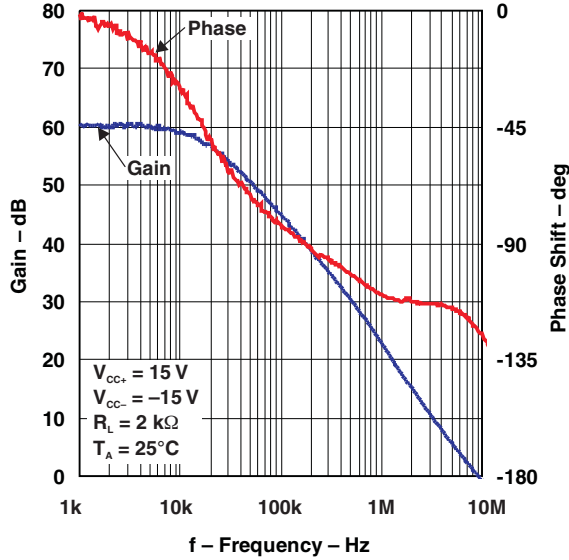

**GAIN AND PHASE MARGIN VS OUTPUT LOAD CAPACITANCE**

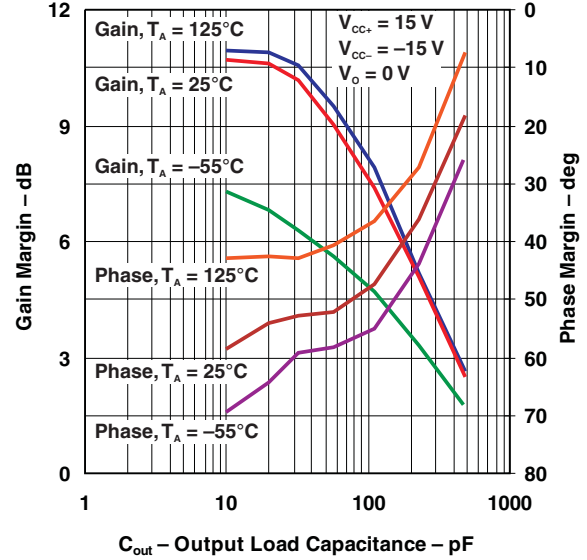

**OVERSHOOT VS OUTPUT LOAD CAPACITANCE**

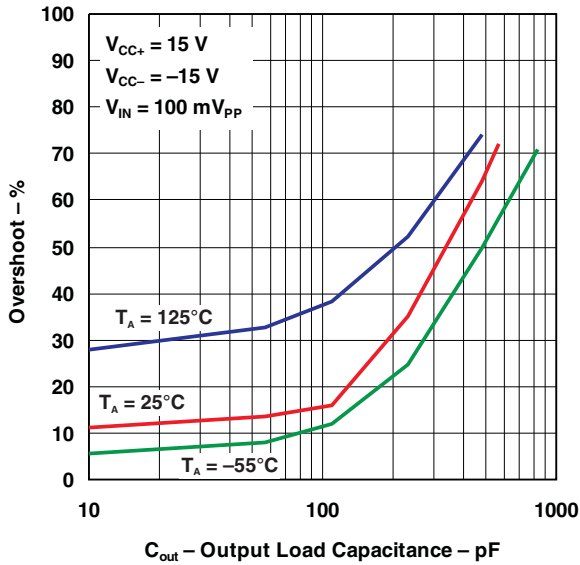

**INPUT VOLTAGE AND CURRENT NOISE VS FREQUENCY**

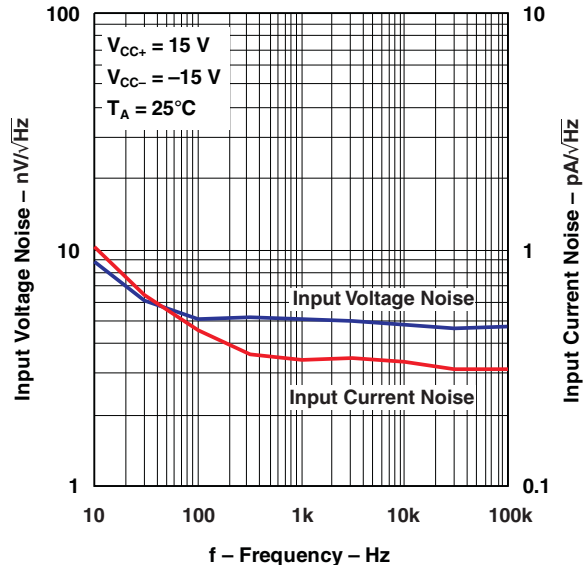

**TYPICAL CHARACTERISTICS (continued)**

**INPUT REFERRED NOISE VOLTAGE  
 VS  
 SOURCE RESISTANCE**

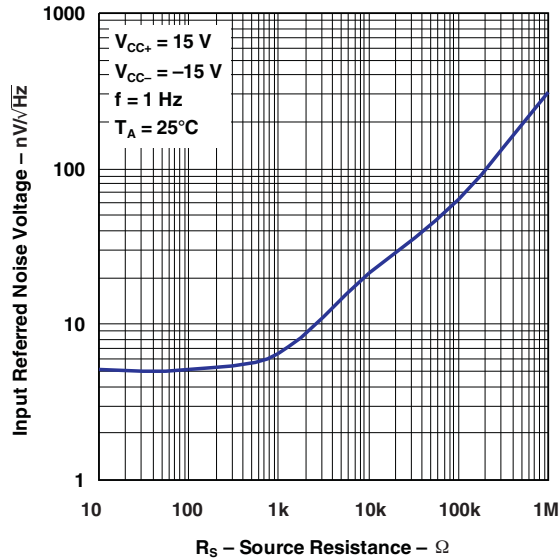

**GAIN AND PHASE MARGIN  
 VS  
 DIFFERENTIAL SOURCE RESISTANCE**

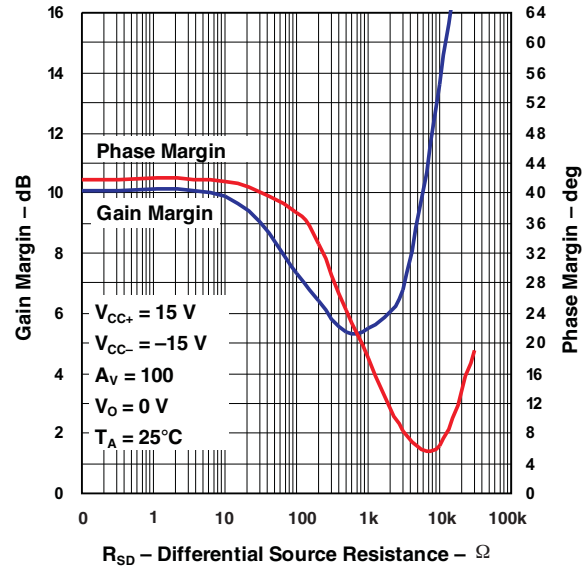

**LARGE SIGNAL TRANSIENT RESPONSE  
 (AV = 1)**

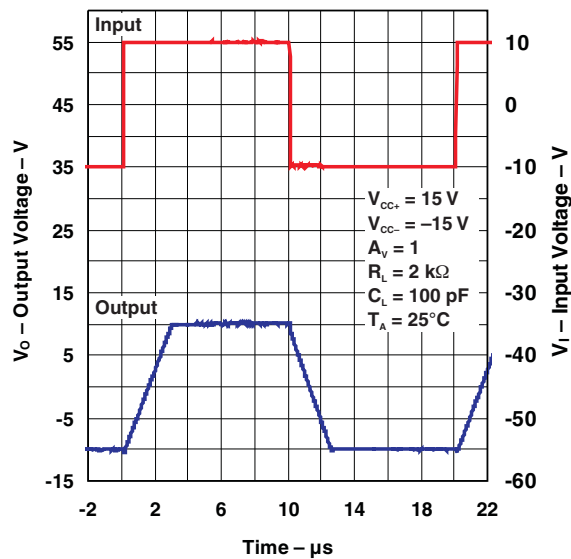

**LARGE SIGNAL TRANSIENT RESPONSE  
 (AV = -1)**

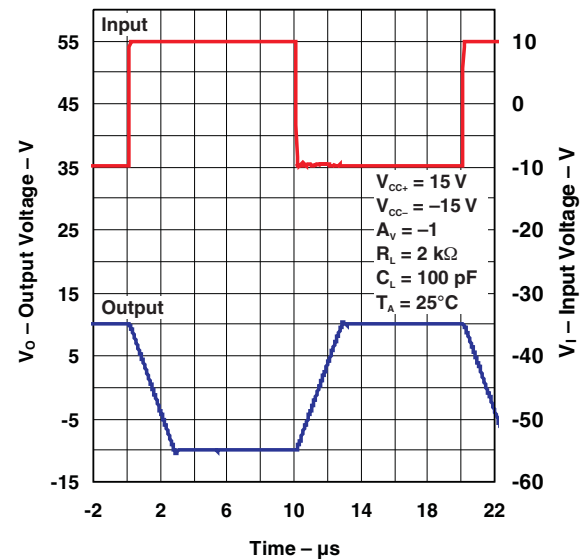

**TYPICAL CHARACTERISTICS (continued)**

**SMALL SIGNAL TRANSIENT RESPONSE**

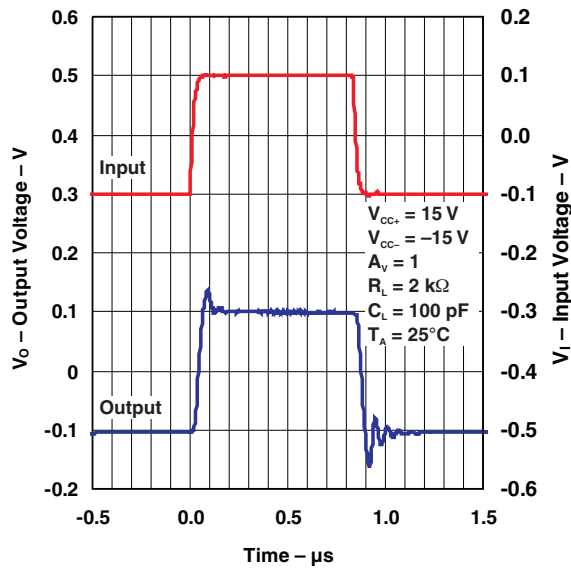

**LOW\_FREQUENCY NOISE**

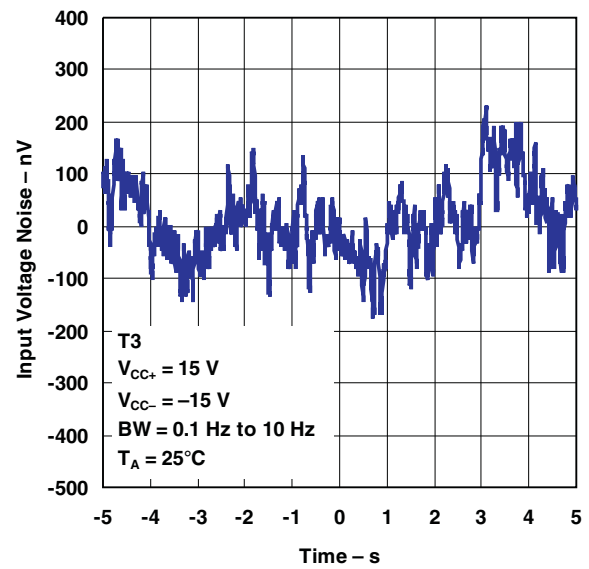

APPLICATION INFORMATION

Output Characteristics

All operating characteristics are specified with 100-pF load capacitance. The MC33078 can drive higher capacitance loads. However, as the load capacitance increases, the resulting response pole occurs at lower frequencies, causing ringing, peaking, or oscillation. The value of the load capacitance at which oscillation occurs varies from lot to lot. If an application appears to be sensitive to oscillation due to load capacitance, adding a small resistance in series with the load should alleviate the problem (see Figure 2).

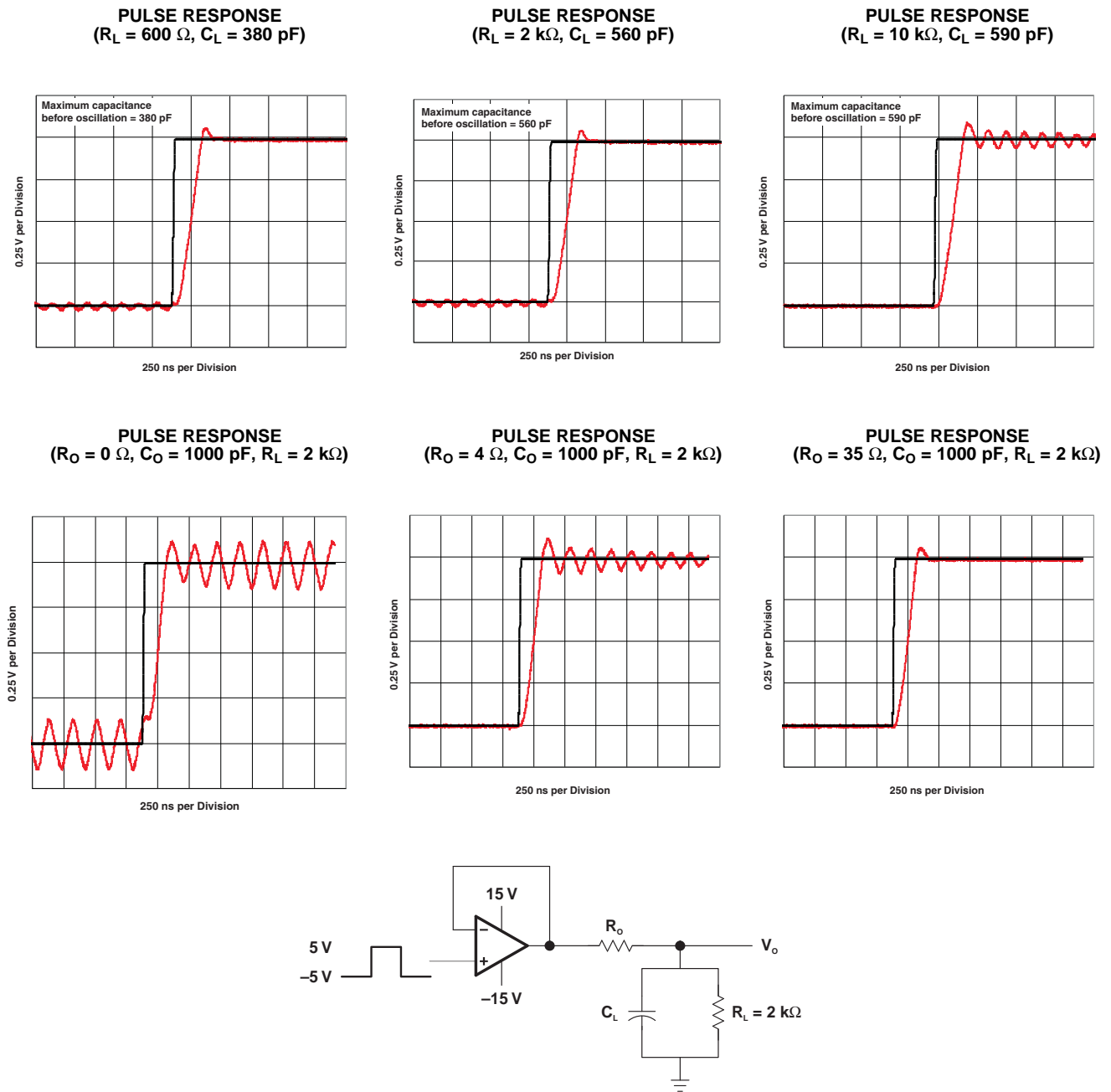

Figure 2. Output Characteristics

**PACKAGING INFORMATION**

Orderable Device	Status <sup>(1)</sup>	Package Type	Package Drawing	Pins	Package Qty	Eco Plan <sup>(2)</sup>	Lead/Ball Finish	MSL Peak Temp <sup>(3)</sup>
MC33078D	ACTIVE	SOIC	D	8	75	Green (RoHS & no Sb/Br)	CU NIPDAU	Level-1-260C-UNLIM
MC33078DE4	ACTIVE	SOIC	D	8	75	Green (RoHS & no Sb/Br)	CU NIPDAU	Level-1-260C-UNLIM
MC33078DG4	ACTIVE	SOIC	D	8	75	Green (RoHS & no Sb/Br)	CU NIPDAU	Level-1-260C-UNLIM
MC33078DGKR	ACTIVE	MSOP	DGK	8	2500	Green (RoHS & no Sb/Br)	CU NIPDAU	Level-1-260C-UNLIM
MC33078DGKRG4	ACTIVE	MSOP	DGK	8	2500	Green (RoHS & no Sb/Br)	CU NIPDAU	Level-1-260C-UNLIM
MC33078DGKT	ACTIVE	MSOP	DGK	8	250	Green (RoHS & no Sb/Br)	CU NIPDAU	Level-1-260C-UNLIM
MC33078DGKTG4	ACTIVE	MSOP	DGK	8	250	Green (RoHS & no Sb/Br)	CU NIPDAU	Level-1-260C-UNLIM
MC33078DR	ACTIVE	SOIC	D	8	2500	Green (RoHS & no Sb/Br)	CU NIPDAU	Level-1-260C-UNLIM
MC33078DRE4	ACTIVE	SOIC	D	8	2500	Green (RoHS & no Sb/Br)	CU NIPDAU	Level-1-260C-UNLIM
MC33078DRG4	ACTIVE	SOIC	D	8	2500	Green (RoHS & no Sb/Br)	CU NIPDAU	Level-1-260C-UNLIM
MC33078P	ACTIVE	PDIP	P	8	50	Pb-Free (RoHS)	CU NIPDAU	N / A for Pkg Type
MC33078PE4	ACTIVE	PDIP	P	8	50	Pb-Free (RoHS)	CU NIPDAU	N / A for Pkg Type

<sup>(1)</sup> The marketing status values are defined as follows:

**ACTIVE:** Product device recommended for new designs.

**LIFEBUY:** TI has announced that the device will be discontinued, and a lifetime-buy period is in effect.

**NRND:** Not recommended for new designs. Device is in production to support existing customers, but TI does not recommend using this part in a new design.

**PREVIEW:** Device has been announced but is not in production. Samples may or may not be available.

**OBSOLETE:** TI has discontinued the production of the device.

<sup>(2)</sup> Eco Plan - The planned eco-friendly classification: Pb-Free (RoHS), Pb-Free (RoHS Exempt), or Green (RoHS & no Sb/Br) - please check <http://www.ti.com/productcontent> for the latest availability information and additional product content details.

**TBD:** The Pb-Free/Green conversion plan has not been defined.

**Pb-Free (RoHS):** TI's terms "Lead-Free" or "Pb-Free" mean semiconductor products that are compatible with the current RoHS requirements for all 6 substances, including the requirement that lead not exceed 0.1% by weight in homogeneous materials. Where designed to be soldered at high temperatures, TI Pb-Free products are suitable for use in specified lead-free processes.

**Pb-Free (RoHS Exempt):** This component has a RoHS exemption for either 1) lead-based flip-chip solder bumps used between the die and package, or 2) lead-based die adhesive used between the die and leadframe. The component is otherwise considered Pb-Free (RoHS compatible) as defined above.

**Green (RoHS & no Sb/Br):** TI defines "Green" to mean Pb-Free (RoHS compatible), and free of Bromine (Br) and Antimony (Sb) based flame retardants (Br or Sb do not exceed 0.1% by weight in homogeneous material)

<sup>(3)</sup> MSL, Peak Temp. -- The Moisture Sensitivity Level rating according to the JEDEC industry standard classifications, and peak solder temperature.

**Important Information and Disclaimer:** The information provided on this page represents TI's knowledge and belief as of the date that it is provided. TI bases its knowledge and belief on information provided by third parties, and makes no representation or warranty as to the accuracy of such information. Efforts are underway to better integrate information from third parties. TI has taken and continues to take reasonable steps to provide representative and accurate information but may not have conducted destructive testing or chemical analysis on incoming materials and chemicals. TI and TI suppliers consider certain information to be proprietary, and thus CAS numbers and other limited information may not be available for release.

In no event shall TI's liability arising out of such information exceed the total purchase price of the TI part(s) at issue in this document sold by TI to Customer on an annual basis.

**OTHER QUALIFIED VERSIONS OF MC33078 :**

- Enhanced Product: [MC33078-EP](#)

NOTE: Qualified Version Definitions:

- Enhanced Product - Supports Defense, Aerospace and Medical Applications



## TAPE AND REEL INFORMATION



### QUADRANT ASSIGNMENTS FOR PIN 1 ORIENTATION IN TAPE



\*All dimensions are nominal

Device	Package Type	Package Drawing	Pins	SPQ	Reel Diameter (mm)	Reel Width W1 (mm)	A0 (mm)	B0 (mm)	K0 (mm)	P1 (mm)	W (mm)	Pin1 Quadrant
MC33078DGKR	MSOP	DGK	8	2500	330.0	12.4	5.3	3.3	1.3	8.0	12.0	Q1
MC33078DGKT	MSOP	DGK	8	250	180.0	12.4	5.3	3.3	1.3	8.0	12.0	Q1
MC33078DR	SOIC	D	8	2500	330.0	12.4	6.4	5.2	2.1	8.0	12.0	Q1
MC33078DR	SOIC	D	8	2500	330.0	12.4	6.4	5.2	2.1	8.0	12.0	Q1

**TAPE AND REEL BOX DIMENSIONS**

\*All dimensions are nominal

Device	Package Type	Package Drawing	Pins	SPQ	Length (mm)	Width (mm)	Height (mm)
MC33078DGKR	MSOP	DGK	8	2500	346.0	346.0	35.0
MC33078DGKT	MSOP	DGK	8	250	220.0	205.0	50.0
MC33078DR	SOIC	D	8	2500	340.5	338.1	20.6
MC33078DR	SOIC	D	8	2500	346.0	346.0	29.0

P (R-PDIP-T8)

PLASTIC DUAL-IN-LINE PACKAGE



4040082/E 04/2010

- NOTES:
- A. All linear dimensions are in inches (millimeters).
  - B. This drawing is subject to change without notice.
  - C. Falls within JEDEC MS-001 variation BA.

DGK (S-PDSO-G8)

PLASTIC SMALL-OUTLINE PACKAGE



- NOTES:
- A. All linear dimensions are in millimeters.
  - B. This drawing is subject to change without notice.
  - C. Body length does not include mold flash, protrusions, or gate burrs. Mold flash, protrusions, or gate burrs shall not exceed 0.15 per end.
  - D. Body width does not include interlead flash. Interlead flash shall not exceed 0.50 per side.
  - E. Falls within JEDEC MO-187 variation AA, except interlead flash.

D (R-PDSO-G8)

PLASTIC SMALL-OUTLINE PACKAGE

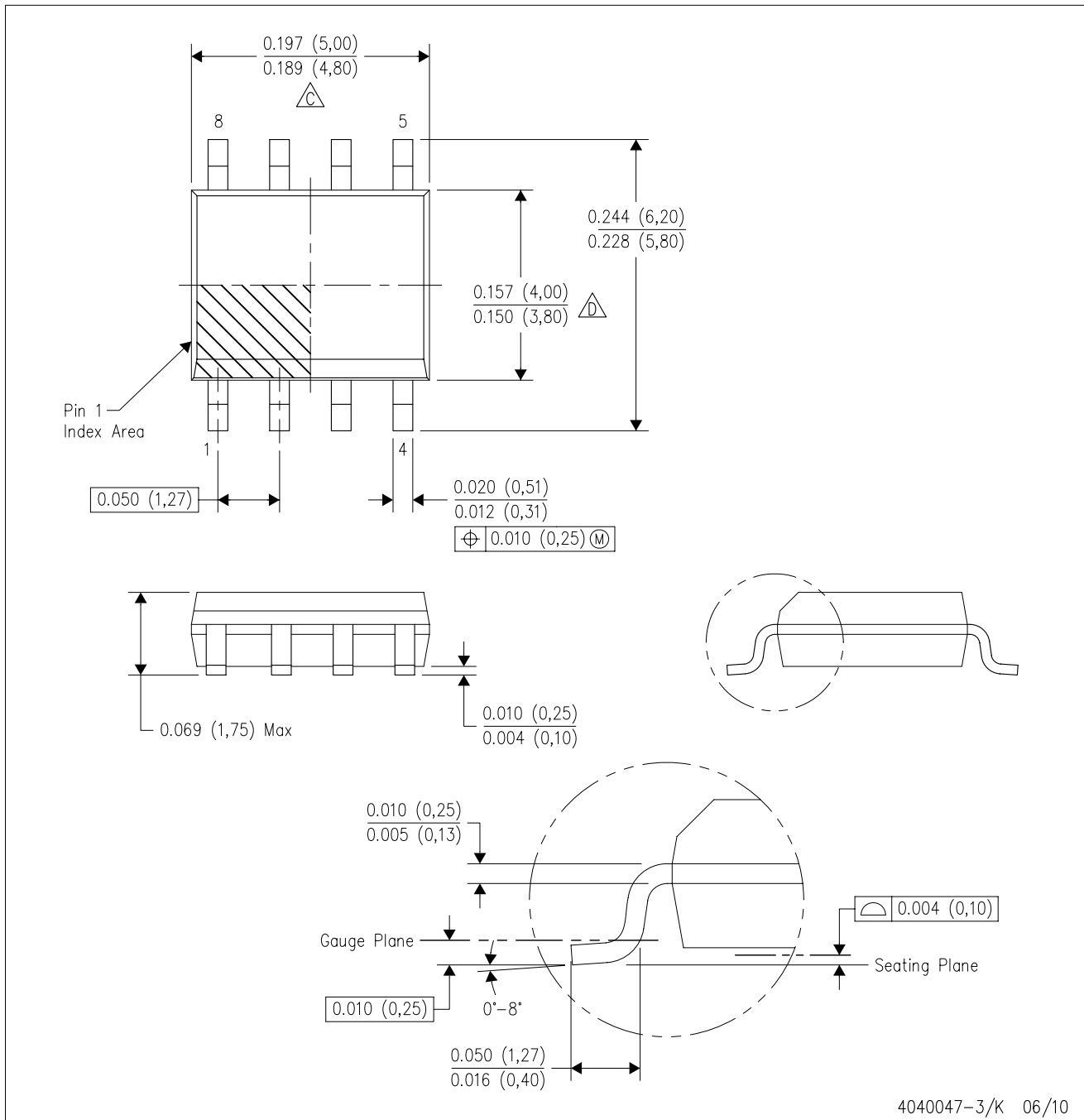

- NOTES:
- A. All linear dimensions are in inches (millimeters).
  - B. This drawing is subject to change without notice.
  - C. Body length does not include mold flash, protrusions, or gate burrs. Mold flash, protrusions, or gate burrs shall not exceed .006 (0,15) per end.
  - D. Body width does not include interlead flash. Interlead flash shall not exceed .017 (0,43) per side.
  - E. Reference JEDEC MS-012 variation AA.

## IMPORTANT NOTICE

Texas Instruments Incorporated and its subsidiaries (TI) reserve the right to make corrections, modifications, enhancements, improvements, and other changes to its products and services at any time and to discontinue any product or service without notice. Customers should obtain the latest relevant information before placing orders and should verify that such information is current and complete. All products are sold subject to TI's terms and conditions of sale supplied at the time of order acknowledgment.

TI warrants performance of its hardware products to the specifications applicable at the time of sale in accordance with TI's standard warranty. Testing and other quality control techniques are used to the extent TI deems necessary to support this warranty. Except where mandated by government requirements, testing of all parameters of each product is not necessarily performed.

TI assumes no liability for applications assistance or customer product design. Customers are responsible for their products and applications using TI components. To minimize the risks associated with customer products and applications, customers should provide adequate design and operating safeguards.

TI does not warrant or represent that any license, either express or implied, is granted under any TI patent right, copyright, mask work right, or other TI intellectual property right relating to any combination, machine, or process in which TI products or services are used. Information published by TI regarding third-party products or services does not constitute a license from TI to use such products or services or a warranty or endorsement thereof. Use of such information may require a license from a third party under the patents or other intellectual property of the third party, or a license from TI under the patents or other intellectual property of TI.

Reproduction of TI information in TI data books or data sheets is permissible only if reproduction is without alteration and is accompanied by all associated warranties, conditions, limitations, and notices. Reproduction of this information with alteration is an unfair and deceptive business practice. TI is not responsible or liable for such altered documentation. Information of third parties may be subject to additional restrictions.

Resale of TI products or services with statements different from or beyond the parameters stated by TI for that product or service voids all express and any implied warranties for the associated TI product or service and is an unfair and deceptive business practice. TI is not responsible or liable for any such statements.

TI products are not authorized for use in safety-critical applications (such as life support) where a failure of the TI product would reasonably be expected to cause severe personal injury or death, unless officers of the parties have executed an agreement specifically governing such use. Buyers represent that they have all necessary expertise in the safety and regulatory ramifications of their applications, and acknowledge and agree that they are solely responsible for all legal, regulatory and safety-related requirements concerning their products and any use of TI products in such safety-critical applications, notwithstanding any applications-related information or support that may be provided by TI. Further, Buyers must fully indemnify TI and its representatives against any damages arising out of the use of TI products in such safety-critical applications.

TI products are neither designed nor intended for use in military/aerospace applications or environments unless the TI products are specifically designated by TI as military-grade or "enhanced plastic." Only products designated by TI as military-grade meet military specifications. Buyers acknowledge and agree that any such use of TI products which TI has not designated as military-grade is solely at the Buyer's risk, and that they are solely responsible for compliance with all legal and regulatory requirements in connection with such use.

TI products are neither designed nor intended for use in automotive applications or environments unless the specific TI products are designated by TI as compliant with ISO/TS 16949 requirements. Buyers acknowledge and agree that, if they use any non-designated products in automotive applications, TI will not be responsible for any failure to meet such requirements.

Following are URLs where you can obtain information on other Texas Instruments products and application solutions:

<b>Products</b>		<b>Applications</b>	
Amplifiers	<a href="http://amplifier.ti.com">amplifier.ti.com</a>	Audio	<a href="http://www.ti.com/audio">www.ti.com/audio</a>
Data Converters	<a href="http://dataconverter.ti.com">dataconverter.ti.com</a>	Automotive	<a href="http://www.ti.com/automotive">www.ti.com/automotive</a>
DLP® Products	<a href="http://www.dlp.com">www.dlp.com</a>	Communications and Telecom	<a href="http://www.ti.com/communications">www.ti.com/communications</a>
DSP	<a href="http://dsp.ti.com">dsp.ti.com</a>	Computers and Peripherals	<a href="http://www.ti.com/computers">www.ti.com/computers</a>
Clocks and Timers	<a href="http://www.ti.com/clocks">www.ti.com/clocks</a>	Consumer Electronics	<a href="http://www.ti.com/consumer-apps">www.ti.com/consumer-apps</a>
Interface	<a href="http://interface.ti.com">interface.ti.com</a>	Energy	<a href="http://www.ti.com/energy">www.ti.com/energy</a>
Logic	<a href="http://logic.ti.com">logic.ti.com</a>	Industrial	<a href="http://www.ti.com/industrial">www.ti.com/industrial</a>
Power Mgmt	<a href="http://power.ti.com">power.ti.com</a>	Medical	<a href="http://www.ti.com/medical">www.ti.com/medical</a>
Microcontrollers	<a href="http://microcontroller.ti.com">microcontroller.ti.com</a>	Security	<a href="http://www.ti.com/security">www.ti.com/security</a>
RFID	<a href="http://www.ti-rfid.com">www.ti-rfid.com</a>	Space, Avionics & Defense	<a href="http://www.ti.com/space-avionics-defense">www.ti.com/space-avionics-defense</a>
RF/IF and ZigBee® Solutions	<a href="http://www.ti.com/lprf">www.ti.com/lprf</a>	Video and Imaging	<a href="http://www.ti.com/video">www.ti.com/video</a>
		Wireless	<a href="http://www.ti.com/wireless-apps">www.ti.com/wireless-apps</a>

Mailing Address: Texas Instruments, Post Office Box 655303, Dallas, Texas 75265  
Copyright © 2010, Texas Instruments Incorporated