

## FEATURES

- Industry Standard 3"x5" Size.
- 90-264Vac Universal Input
- VDE 0871'B' & FCC'B' Compliance
- 100% Burn-In Test
- Over Voltage Protection Installation
- Short-Circuit Protection Installation
- Protection Type: Auto-Recovery



## SPECIFICATION

Model	T40-9311	T40-9311A
Item		
Input Voltage	AC 90~264V	
Input Frequency	47~63Hz	
Efficiency	73% Typical	
Operating Temperature	0~50°C	
Storage Temperature	-20~85°C	
Weight	210g/7.4oz	
Safety Description	UL, CSA, TUV, CB	UL, CSA, TUV, CB, CE

(\*) : Under Development (I/P): In Process

### MECHANICAL

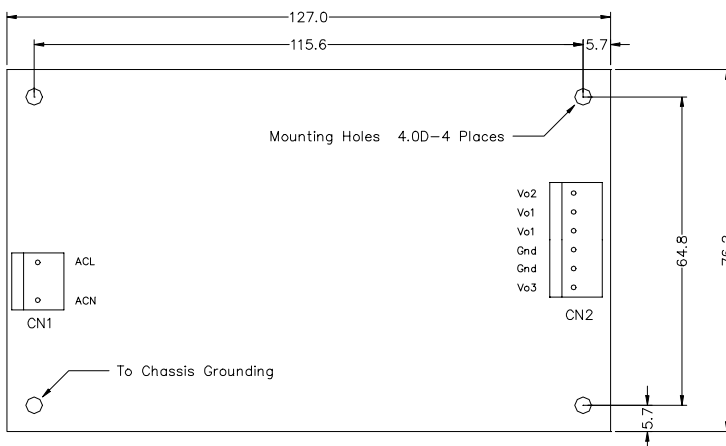

Unit: m.m.

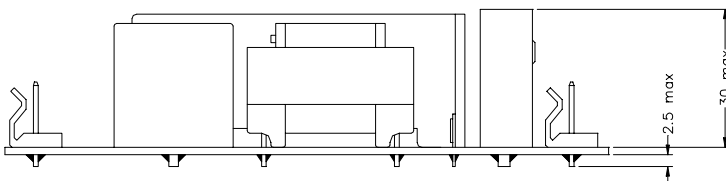

### OUTPUTS

Model No.	T40-9311			T40-9311A		
	Vo1	Vo2	Vo3	Vo1	Vo2	Vo3
	+5V	+15V	-15V	+5V	+12V	-12V
Load	Min	0.3A	0.2A	0.0A	0.3A	0.2A
	Rated	1.8A	2.0A	0.3A	5.0A	1.2A
	Surge	4.5A	2.4A	---	---	2.5A
Regulation	Line	1%	1%	1%	1%	1%
	Load	3%	5%	5%	3%	5%
Tolerance	+/-3%	+10/-5%	+10/-5%	+/-4%	+/-5%	+10/-5%
Ripple Noise	50mV	150mV	200mV	50mV	120mV	120mV

Ref. No.	Connector Type	Mating Connector Type
CN1	MOLEX 09-65-1038 or Equivalent	MOLEX 09-50-1031 or Equivalent
CN2	MOLEX 09-65-2068 or Equivalent	MOLEX 09-50-1061 or Equivalent