

# PISCES II DC/DC CONVERTERS

## 48V Input – 5.0VDC – 30A Output



G2PW5V030

### G2PW5V030 – 1/4 Brick Pisces II Series

- Industry standard pinout and footprint
- Very low dissipation
- No heat sink required for most applications
- Low profile, 0.38"
- High efficiency: 91% at 5.0V, 30A; 93% at 5.0V, 15A
- Very low common-mode noise for a commercial DC/DC converter
- Two-stage input filter
- Constant switching frequency
- Remote sense, wide trim range
- Single board design, very low parts count
- Optional baseplate or low profile heat sink for improved thermal performance
- Header with M3 metal inserts for mechanical connection to PCB

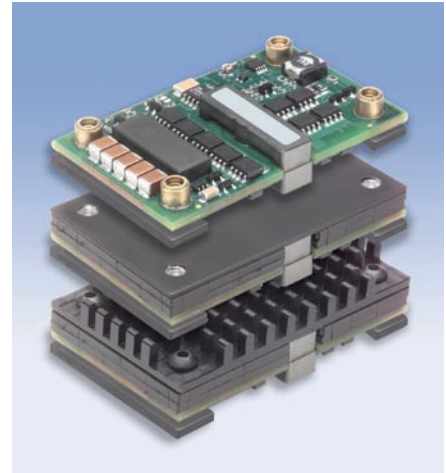

### Control Functions

- Uses patented power supply control and architecture
- Microprocessor controlled
- Primary-side enable, choice of logic

### Protection Features

- Over temperature protection
- Over voltage protection
- Over current protection
- Over/Under input voltage protection

### Typical Characteristics

- Output setpoint accuracy:  $\pm 1\%$
- Load regulation:  $\pm 0.2\%$
- Line regulation:  $\pm 0.2\%$
- Regulation over line, load, and temperature:  $\pm 2\%$
- Low output ripple
- Output trim



Certified to ISO 9001:2000

### Ordering Information

Standard Model Number	Input Voltage	Output Voltage	Max Current
G2PW5V030*	48V	5.0V	30A

\* **Options:** E = 0.18" Pins ( $\pm .01"$ ) R = Heat Sink Ready  
 P = Positive Logic Version; M = 0.145" Pins ( $\pm .01"$ ) T = Tuned model\*\*  
 High = On S = 0.12" Pins ( $\pm .01"$ )

### Pisces II Heat Sink Part Numbers

Part Number	Height	Typical Thermal Performance	
		Natural Convection Power Dissipation†	Forced Convection Thermal Resistance‡
001	0.25"	5W	5.8° C/W
002	0.50"	7W	3.2° C/W
003	1.00"	11W	2.0° C/W
004	0.13"	TBD	TBD
005	0.70"	TBD	TBD

† @ 60° C rise heat sink to ambient      ‡ @ 300'/min.

Example Part Number: (All options)

**G2PW5V030 PSRT 00X**

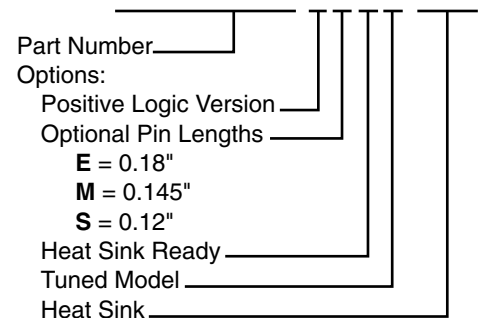

### \*\* T (Tuned Model) Option

Designed for higher di/dt and  $\Delta I$  applications, the transient response has been modified to take advantage of the capacitance on the customer's PCB. This unit requires a minimum load capacitance of 5600 $\mu$ F with an impedance magnitude of less than 0.005 $\Omega$  at 15kHz. It offers a minimum 3X improvement in the peak response compared to a standard unit. Consult factory.

G2PW5V030

### Input Specifications

Parameter	Min	Typical	Max	Units
Operating Input Voltage	36	48	75	V <sub>DC</sub>
Input Current			6	A
Input Capacitance		4		μF
Input Hysteresis, Low Line		2		V <sub>DC</sub>

V<sub>IN</sub> = 48V<sub>DC</sub>, T<sub>A</sub> @ 25° C, 300 LFM Airflow, V<sub>OUT</sub> = 5.0V<sub>DC</sub>, I<sub>OUT</sub> = Full load unless otherwise noted.  
 Available output power depends on ambient temperature and good thermal management.  
 (See application graphs for limits.)

### Output Specifications

Parameter	Min	Typical	Max	Units
Regulation Over Line, Load & Temperature	98		102	%V <sub>NOM</sub>
Voltage Ripple			25	mV <sub>RMS</sub>
Voltage Ripple, 20MHz BW			85	mV <sub>P-P</sub>
Current Range	0		30	A
Current Limit Inception	103		140	%I <sub>OUT</sub>
Short Circuit Current, Peak <sup>1</sup>			45	A
Output Transient Response, 50% to 75% Load Change, 1A/μsec			5	%V <sub>OUT</sub>
Settling Time to ± 1%			200	μS
Turn-on Time to 98% Vnom			35	mS
Output Overshoot at Turn-on		0		%V <sub>OUT</sub>
Trim Range	70		110	%V <sub>OUT</sub>
Over Voltage Protection, Latching		130		%V <sub>OUT</sub>

1. During short circuit, converter will shut down and attempt to restart once per second. The average current during this condition will be very low and the device can be safely left in this condition continuously.

# PISCES II DC/DC CONVERTERS

## 48V Input – 5.0VDC – 30A Output



G2PW5V030

### Isolation Specifications

Parameter	Min	Typical	Max	Units
Isolation Test Voltage, Input/Output (Basic)	2250			V <sub>DC</sub>
Isolation Test Voltage, Input/Case	2000			V <sub>DC</sub>
Isolation Test Voltage, Output Case	500			V <sub>DC</sub>
Isolation Resistance	10			MΩ

### Features

Parameter	Min	Typical	Max	Units
Over Temperature Protection, Thermal Sensor, Latching <sup>2</sup>			110	° C
Switching Frequency, Fixed		250		kHz

2. PCB less than 130° C.

### General Specifications

Operating Temperature	-40° C to + 100° C
Storage Temperature	-55° C + 125° C
Relative Humidity	10% to 95% RH, Non-condensing
Vibration	2 to 9 Hz, 3mm disp., 9 to 200 Hz, 1g
Material Flammability	UL V-0
Weight	35 grams
MTBF Telcordia (Bellcore)	1.6 million hours

### Approvals and Standards

UL and c-UL Recognized Component, TUV\*\*,  
UL60950, CSA 22.2 No. 950, IEC/EN 60950

#### EMC Characteristics:

Designed to meet emission and immunity requirements per EN55022, CISPR 22, Class B, and CISPR 24.

\*\* An external fuse shall be used to comply with the requirements.

**Application Notes**

**CoolConverter™**

**Bel Power’s Proprietary CoolConverter™**

- Patented single-stage power conversion architecture, control and magnetic design allow unprecedented power density and efficiency in an isolated power supply.
- An advanced microcontroller reduces parts count while adding features, performance and flexibility in the design.
- Low common-mode noise results from lower capacitance in the transformer from balanced winding design.

**Protection and Control**

**Valid Input Voltage Range**

The converter measures the input voltage and will not allow operation outside of the input voltage specification. As shown by the graphs, hysteresis is added to both the high and low voltage to prevent the converter from turning on and off repeatedly when the voltage is held near either voltage extreme. At low line, this assures the maximum input current is not exceeded; at high line, this assures the semiconductor devices in the converter are not damaged by excessive voltage stress.

**ON/OFF Logic Option**

The ON/OFF control logic can be either Negative (standard) or Positive to enable the converter. For Negative logic, the ON/OFF pin is brought to below 1.0V with respect to the –INPUT pin to enable the converter. The pull-down must be able to sink 100µA. For Positive logic, the ON/OFF pin is brought to greater than 4.0V with respect to the –INPUT pin and be limited to less than 10V. To request the Positive logic version, add the suffix (P) to the standard part number. The ON/OFF pin has a built-in pull-up resistor of approximately 100kΩ to +5V.

**Output Over Voltage Protection**

The output voltage is constantly monitored by the microprocessor with a redundant secondary-side measurement circuit that both shuts down the duty cycle and triggers the microprocessor to shut down. If the output voltage exceeds the over voltage specification, the microprocessor will latch the converter off. To turn the converter on required either cycling the ON/OFF pin or power to the converter. This advanced feature prevents the converter from damaging the load if there is a converter failure or application error. If non-latching is required, consult factory.

**Over Voltage Hysteresis**

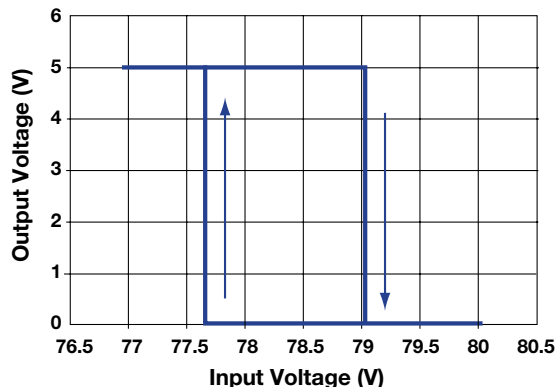

**Under Voltage Hysteresis**

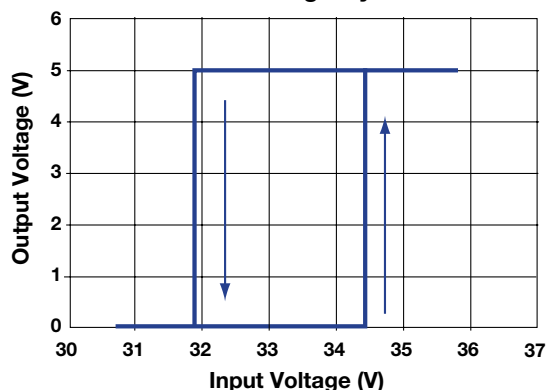

# PISCES II DC/DC CONVERTERS

48V Input – 5.0VDC – 30A Output



G2PW5V030

## CoolConverter™

### Protection and Control

#### Thermal Shutdown

The printed circuit board temperature is measured using a semiconductor sensor. If the maximum rated temperature is exceeded, the converter is latched off. To re-enable the converter requires cycling the ON/OFF pin or power to the converter. If non-latching is required, consult factory.

#### Control Options

As the behavior of the circuit is determined by firmware in the microcontroller, specific requirements, such as:

- non-latching thermal protection
- custom valid input voltage range
- controlled delay from initiating an ON/OFF signal for power sequencing

can be accomplished with no change to hardware. The standard behavior was chosen based on system design experience, but customers may have their own requirements. Please contact Bel Power for any special needs.

#### Remote Sense

The output voltage is regulated at the point where the sense pins connect to the power output pins. Total sense compensation should not exceed 0.4V or 10% of Vout, whichever is greater.

#### Safety

An external input fuse must always be used to meet these safety requirements.

#### External Output Trimming

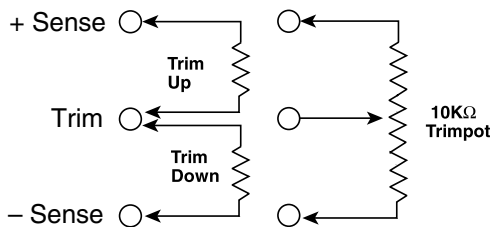

#### Trim

To trim the output voltage higher, connect the required trim resistor from the Trim pin to the +Sense pin. To trim the output voltage lower, connect the required trim resistor from the Trim pin to the -Sense pin.

#### Trim-up

$$R_{\text{TRIM-UP}} = \left\{ \frac{5.0 (100+\Delta\%)}{1.225\Delta\%} - \frac{(100+2\Delta\%)}{\Delta\%} \right\} 5.11\text{k}\Omega$$

#### 5.0V Trim-up

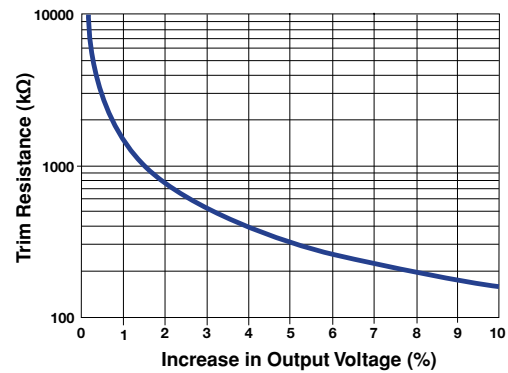

#### Trim-down

$$R_{\text{TRIM-DOWN}} = \left\{ \frac{100}{\Delta\%} - 2 \right\} 5.11\text{k}\Omega$$

#### Trim-down

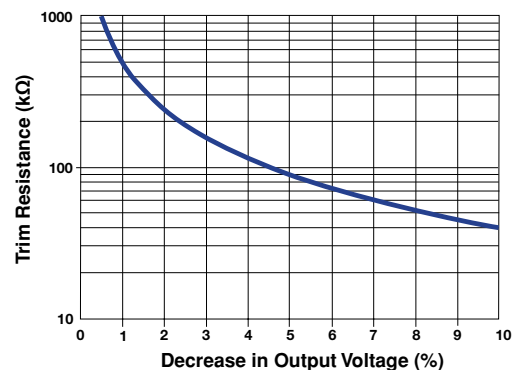

G2PW5V030

### Efficiency Data

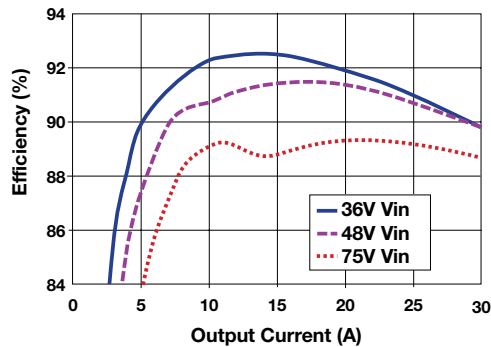

### Power Dissipation

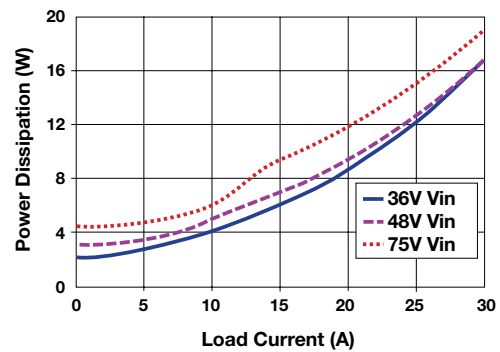

### Start Up

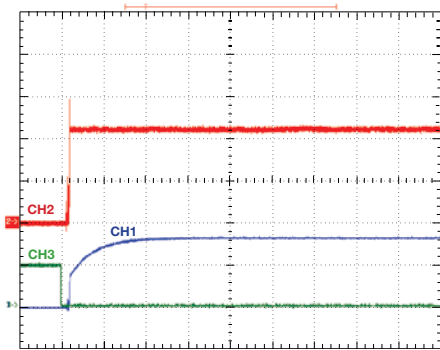

1. V<sub>OUT</sub> 2V/div 10ms/div
2. I<sub>OUT</sub> 10A/div
3. Enable 5V/div

### Voltage Ripple

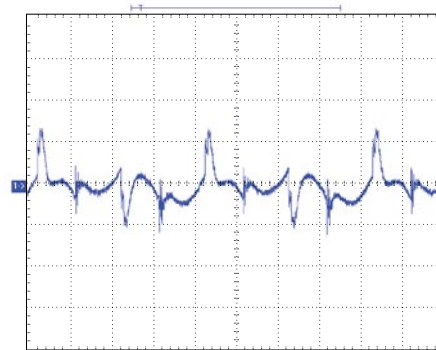

1. V<sub>OUT</sub> 50mV/div 2μs/div
- 10μF ext cap 2MHz BW

### Line/Load Regulation

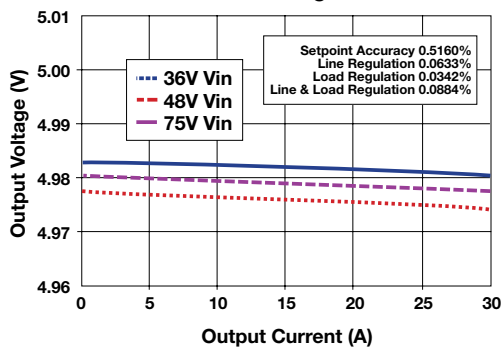

### Transient Response

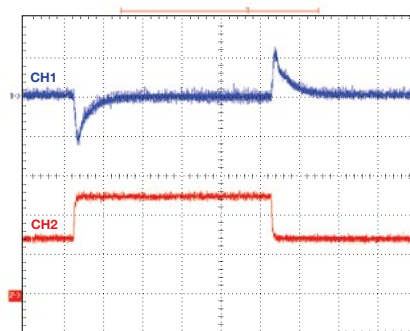

1. V<sub>OUT</sub> 500mV/div 200μs/div
2. I<sub>OUT</sub> 10A/div

# PISCES II DC/DC CONVERTERS

48V Input – 5.0VDC – 30A Output



G2PW5V030

## Back Bias

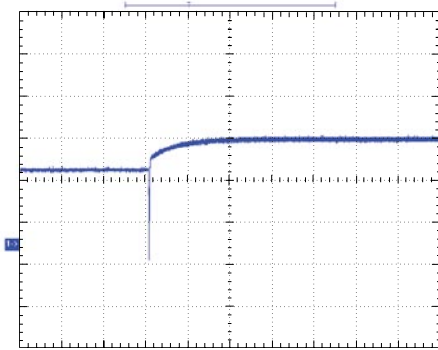

1.  $V_{OUT}$  2V/div 10mS/div

## Over Current Protection

Note: Over current protection is blip-mode (aka hiccup).

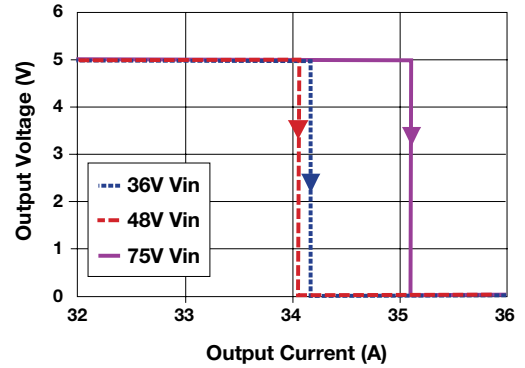

## Over Voltage Protection

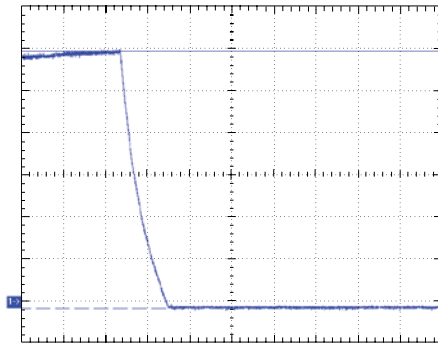

1.  $V_{OUT}$  1V/div 2mS/div

## Thermal Derating

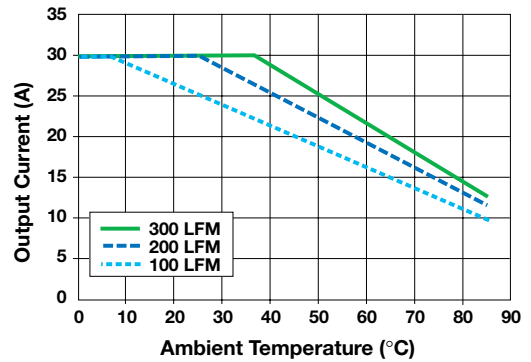

# PISCES II DC/DC CONVERTERS

48V Input – 5.0VDC – 30A Output



G2PW5V030

## Mechanical

G2PW5V030

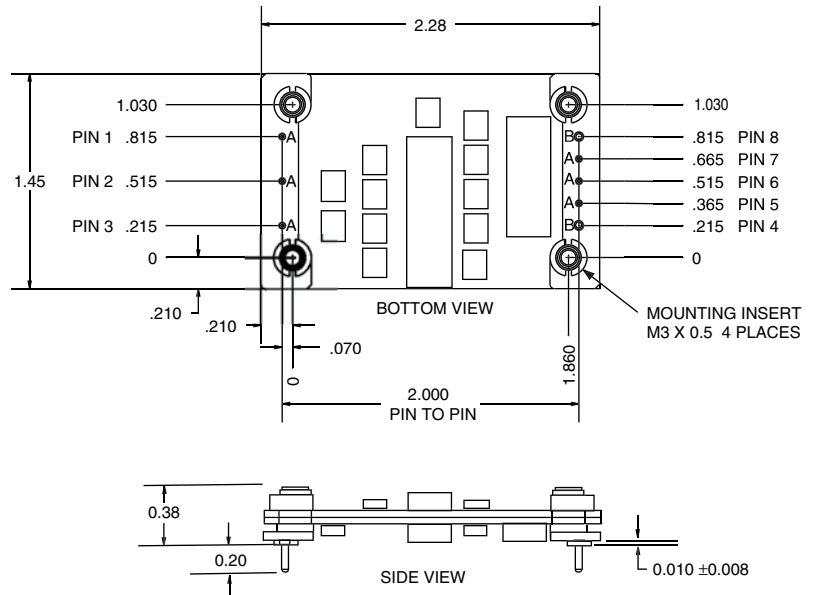

### Pin Configuration – Bottom View

Pin	Function	Pin Dia. (In.)
1	– Input	0.040
2	On/Off	0.040
3	+ Input	0.040
4	+ Output	0.060
5	+ Sense	0.040
6	Trim	0.040
7	– Sense	0.040
8	– Output	0.060

#### Notes:

- Mechanical tolerances  
x.xxx in. = ± 0.005 in.  
x.xx in = ± 0.01 in.
- Pin material: Brass with tin/lead plating over nickel
- Workmanship: Meets or exceeds IPC-A-610B Class II
- "A" = 0.040" dia. pins
- "B" = 0.060" dia. pins
- Min. screw length for heat sink attachment  
= 4.5mm + heat sink flange + locking hardware

### RoHS Compliance

Complies with the European Directive 2002/95/EC, calling for the elimination of lead and other hazardous substances from electronic products. These parts are not however compatible with the higher temperatures associated with lead free solder processes and must be soldered using a reflow profile with a peak temperature of no more than 240°C.



©2006 Bel Fuse Inc. Specifications subject to change without notice. 11.06

#### CORPORATE

**Bel Fuse Inc.**  
206 Van Vorst Street  
Jersey City, NJ 07302  
Tel 201-432-0463  
Fax 201-432-9542  
www.belfuse.com

#### FAR EAST

**Bel Fuse Ltd.**  
8F / 8 Luk Hop Street  
San Po Kong  
Kowloon, Hong Kong  
Tel 852-2328-5515  
Fax 852-2352-3706  
www.belfuse.com

#### EUROPE

**Bel Fuse Europe Ltd.**  
Preston Technology Management Centre  
Marsh Lane, Suite G7, Preston  
Lancashire, PR1 8UD, U.K.  
Tel 44-1772-556601  
Fax 44-1772-888366  
www.belfuse.com