

### Description

The ACE3401 is the P-Channel logic enhancement mode power field effect transistors are produced using high cell density, DMOS trench technology.

This high density process is especially tailored to minimize on-state resistance.

These devices are particularly suited for low voltage application such as cellular phone and notebook computer power management and Battery powered circuits, and low in-line power loss are needed in a very small outline surface mount package.

### Features

- -30V/-4.0A,  $R_{DS(ON)}=55m\Omega @V_{GS}=-10V$
- -30V/-3.2A,  $R_{DS(ON)}=65m\Omega @V_{GS}=-4.5V$
- -30V/-1.2A,  $R_{DS(ON)}=75m\Omega @V_{GS}=-2.5V$
- Super high density cell design for extremely low  $R_{DS(ON)}$
- Exceptional on-resistance and maximum DC current capability
- SOT-23-3L package design

### Application

- Power Management in Note book
- Portable Equipment
- Battery Powered System
- Load Switch
- DSC
- LCD Display inverter

### Absolute Maximum Ratings

( $T_A=25^\circ C$  Unless otherwise noted)

Parameter	Symbol	Typical	Unit
Drain-Source Voltage	$V_{DSS}$	-30	V
Gate-Source Voltage	$V_{GSS}$	$\pm 12$	V
Continuous Drain Current ( $T_J=150^\circ C$ )	$I_D$	$T_A=25^\circ C$	-40
		$T_A=70^\circ C$	-3.2
Pulsed Drain Current	$I_{DM}$	-15	A
Continuous Source Current (Diode Conduction)	$I_S$	-1.0	A
Power Dissipation	$P_D$	$T_A=25^\circ C$	1.25
		$T_A=70^\circ C$	0.8
Operating Junction Temperature	$T_J$	150	$^\circ C$
Storage Temperature Range	$T_{STG}$	-55/150	$^\circ C$
Thermal Resistance-Junction to Ambient	$R_{\theta JA}$	120	$^\circ C/W$

### Packaging Type

SOT-23-3

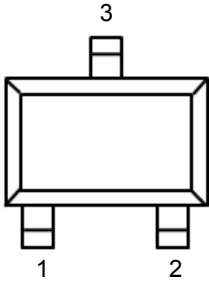

Pin	Description
1	Gate
2	Source
3	Drain

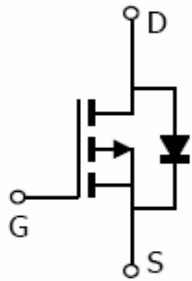

### Ordering information

#### Selection Guide

ACE3401 XX + H

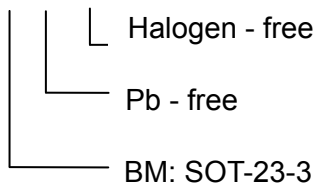

### Electrical Characteristics

(TA=25°C, Unless otherwise noted)

Parameter	Symbol	Conditions	Min.	Typ	Max.	Unit
<b>Static</b>						
Drain-Source Breakdown Voltage	$V_{(BR)DSS}$	$V_{GS}=0V, I_D=-250\mu A$	-30			V
Gate Threshold Voltage	$V_{GS(th)}$	$V_{DS}=V_{GS}, I_D=-250\mu A$	-0.4		-1.0	
Gate Leakage Current	$I_{GSS}$	$V_{DS}=0.V, V_{GS}=\pm 12V$			$\pm 100$	nA
Zero Gate Voltage Drain Current	$I_{DSS}$	$V_{DS}=-24V, V_{GS}=0V$			-1	uA
		$V_{DS}=-24V, V_{GS}=0V, T_J=55^\circ C$			-10	
On-State Drain Current	$I_{D(ON)}$	$V_{DS} \leq -5V, V_{GS}=-10V$	-10			A
Drain-Source On-Resistance	$R_{DS(ON)}$	$V_{GS}=-10V, I_D=-4.0A$		0.045	0.055	Ω
		$V_{GS}=-4.5V, I_D=-3.2A$		0.050	0.065	
		$V_{GS}=-2.5V, I_D=-1.2A$		0.060	0.075	
Forward Transconductance	$G_{fs}$	$V_{DS}=-5.0V, I_D=-4.0A$		10		S
Diode Forward Voltage	$V_{SD}$	$I_S=-1.0A, V_{GS}=0V$		-0.8	-1.2	V
<b>Dynamic</b>						
Total Gate Charge	$Q_g$	$V_{DS}=-15V, V_{GS}=-10V, I_D=-4.0A$		14	21	nC
Gate-Source Charge	$Q_{gs}$			1.9		
Gate-Drain Charge	$Q_{gd}$			3.7		
Input Capacitance	$C_{iss}$	$V_{DS}=-15V, V_{GS}=0V, f=1MHz$		540		pF
Output Capacitance	$C_{oss}$			131		
Reverse Transfer Capacitance	$C_{rss}$			105		
Turn-On Time	$t_{d(on)}$	$V_{DD}=-15V, R_L=15\Omega, I_D=-1.0A, V_{GEN}=-10V, R_G=6\Omega$		10	15	ns
	$t_r$			15	25	
Turn-Off Time	$t_{d(off)}$			31	50	
	$t_f$			20	30	

### Typical Characteristics

Output Characteristics

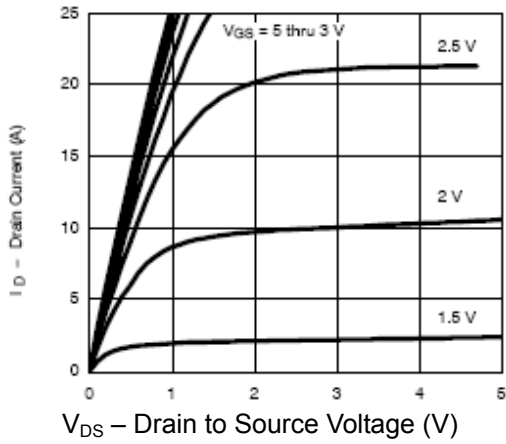

Transfer Characteristics

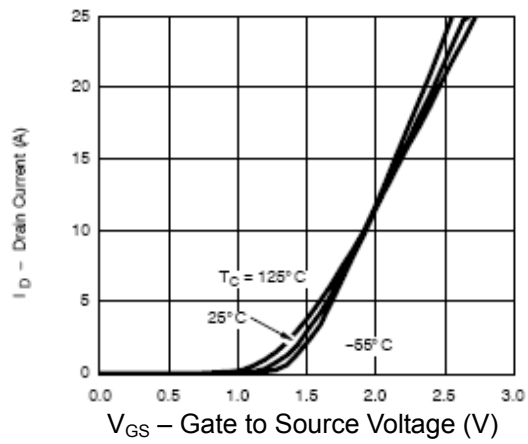

On-Resistance vs. Drain Current

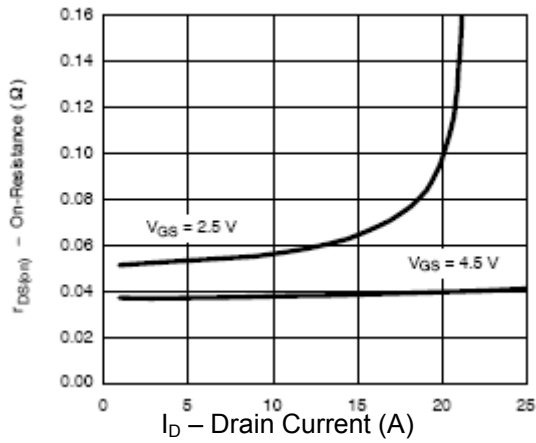

Capacitance

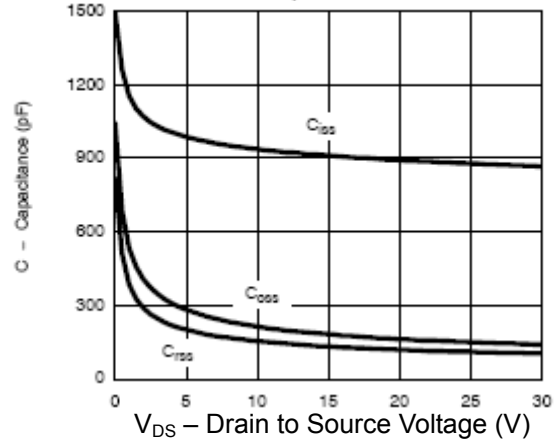

### Typical Characteristics

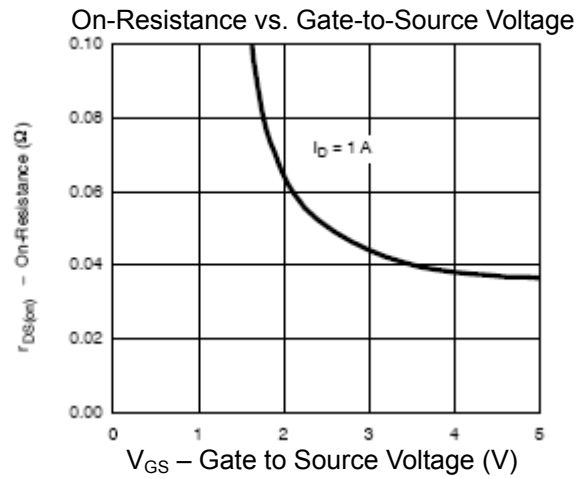
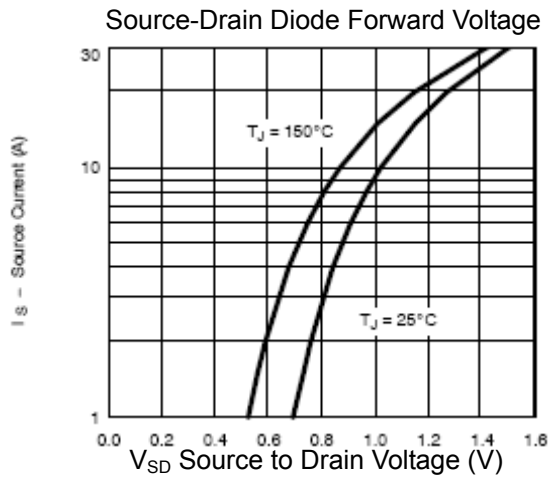
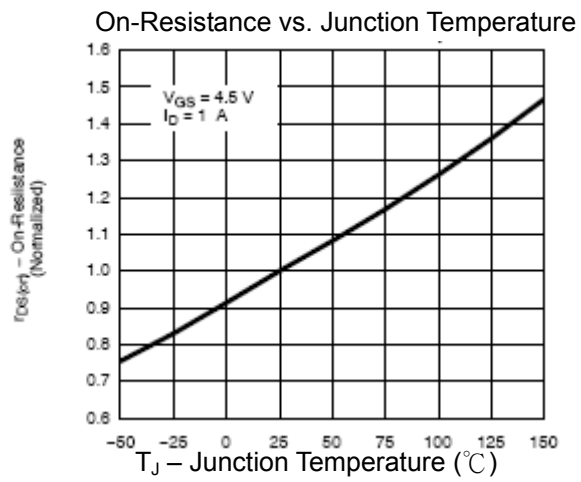
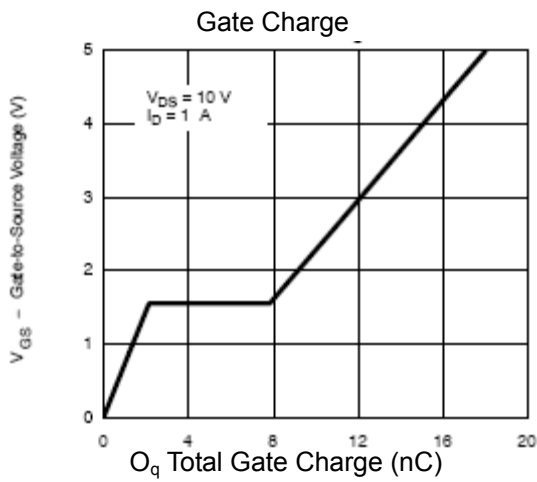

## Typical Characteristics

Threshold Voltage

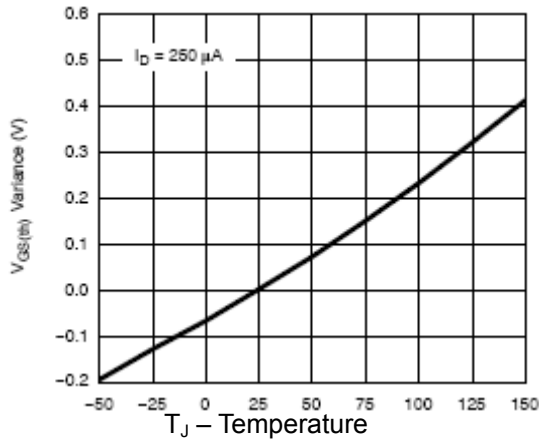

Single Pulse Power, Junction-To-Ambient

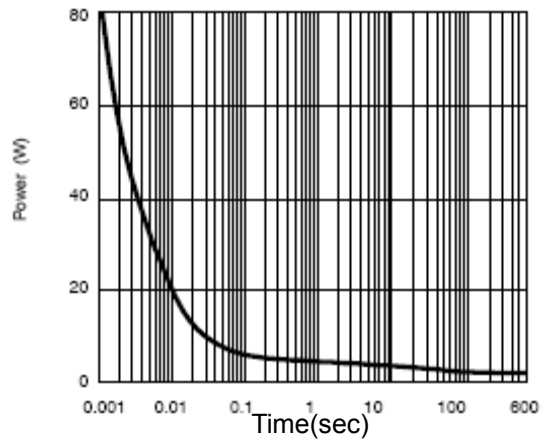

Normalized Thermal Transient Impedance, Junction-to-Foot

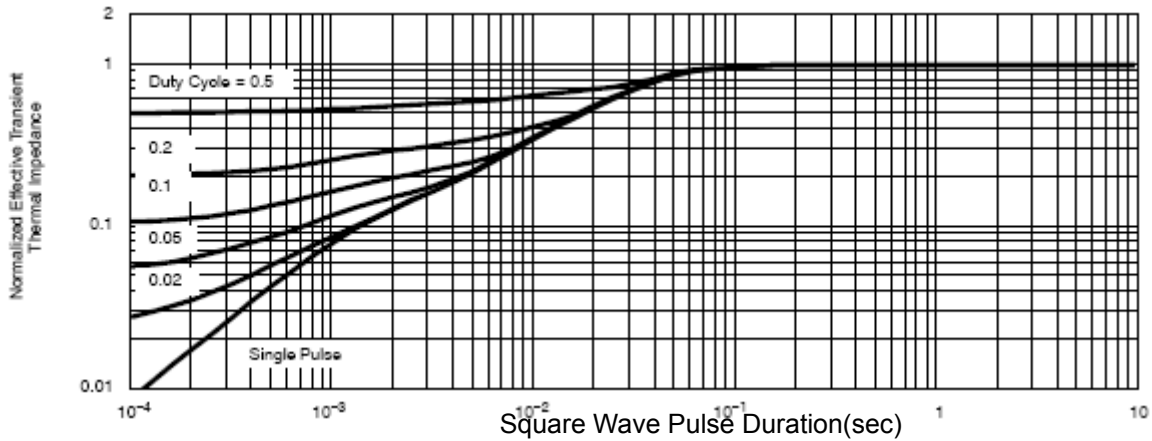

## Packing Information

SOT-23-3

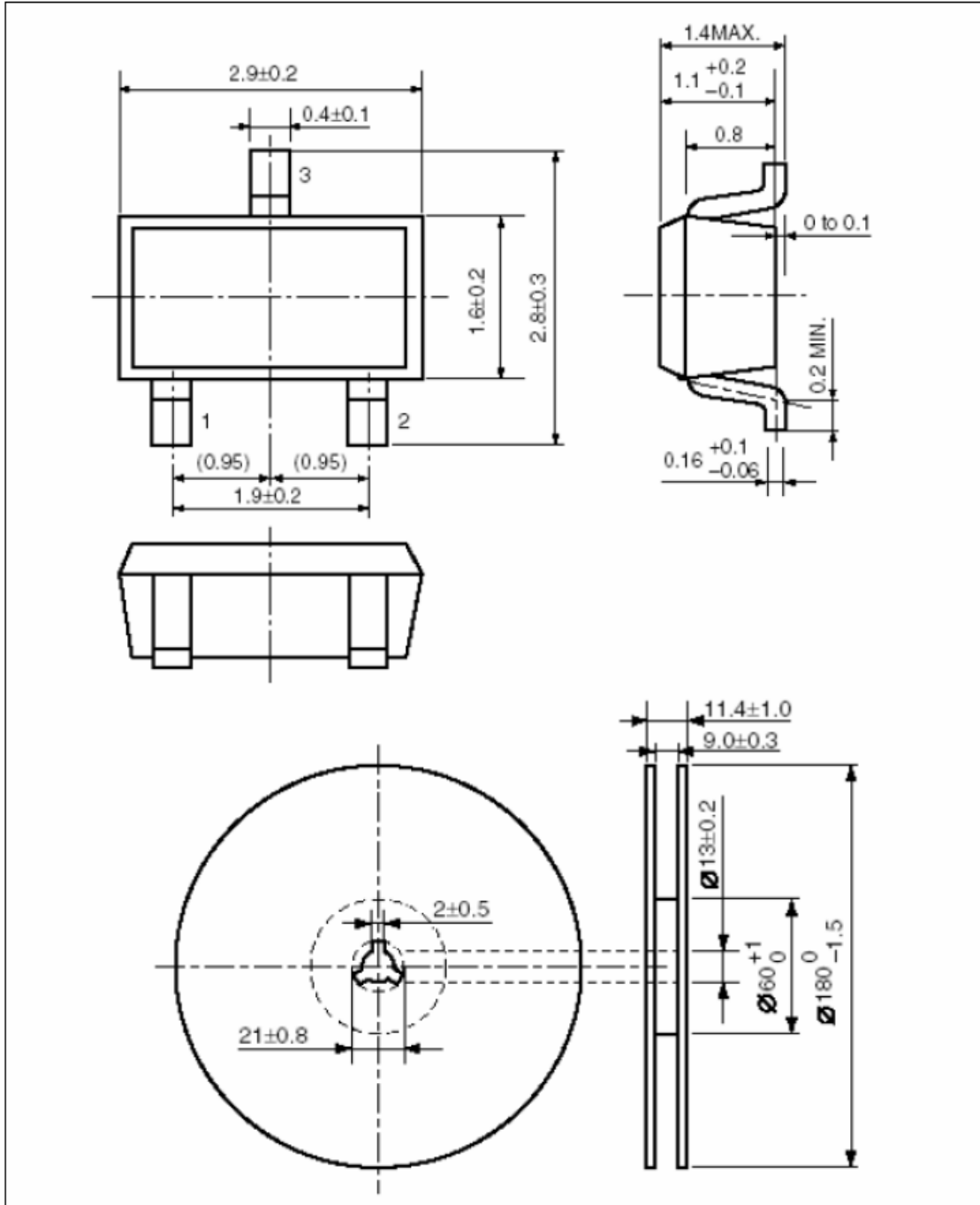

## Notes

ACE does not assume any responsibility for use as critical components in life support devices or systems without the express written approval of the president and general counsel of ACE Electronics Co., LTD. As sued herein:

1. Life support devices or systems are devices or systems which, (a) are intended for surgical implant into the body, or (b) support or sustain life, and whose failure to perform when properly used in accordance with instructions for use provided in the labeling, can be reasonably expected to result in a significant injury to the user.
2. A critical component is any component of a life support device or system whose failure to perform can be reasonably expected to cause the failure of the life support device or system, or to affect its safety or effectiveness.