



FAN5362

3MHz, 500mA / 750mA Synchronous Buck Regulator

Features

- 3MHz Fixed-Frequency Operation
- 45µA Typical Quiescent Current
- 1.80 to 3.6V Fixed Output Voltage
- 500mA or 750mA Output Current Capability
- 2.7V to 5.5V Input Voltage Range
- Smooth Transitions to/from 100% Duty Cycle when V_{IN} Drops
- PFM Mode for High Efficiency in Light Load
- Best-in-Class Load Transient Response
- Best-in-Class Efficiency
- Forced PWM and External Clock Synchronization
- Internal Soft-Start
- Input Under-Voltage Lockout (UVLO)
- Thermal Shutdown and Overload Protection
- 6-Bump WLCSP, 0.4mm Pitch or 6-Lead 2 x 2mm Ultrathin Molded Leadless Package

Applications

- SD Flash Memory Power Supply
- RF Transceiver Power
- Cell Phones, Smart Phones
- Tablets, Netbooks®, Ultra-Mobile PCs
- 3G, LTE, WiMAX™, WiBro®, and WiFi® Data Cards
- Gaming Devices, Digital CamerasDC/DC Micro Modules

Description

The FAN5362 is a 500mA or 705mA, step-down, switching voltage regulator that delivers a fixed output voltage from an input voltage supply of 2.7V to 5.5V. Using a proprietary architecture with synchronous rectification, the FAN5362 is capable of delivering a peak efficiency of 96%, while maintaining efficiency over 90% with load currents as low as 1mA.

This regulator transitions seamlessly into and out of 100% duty cycle operation when the supply dips to or below the regulation setpoint and smoothly recovers full regulation without overshoot when the supply recovers.

The regulator operates at a nominal fixed frequency of 3MHz, which reduces the value of the external components to 1µH for the output inductor and 4.7µF for the output capacitor. The PWM modulator can be synchronized to an external frequency source.

At moderate and light loads, pulse frequency modulation is used to operate the device in power-save mode with a typical quiescent current of 45µA. Even with such a low quiescent current, the part exhibits excellent transient response during large load swings. At higher loads, the system automatically switches to fixed-frequency control, operating at 3MHz. In shutdown mode, the supply current drops below 1µA, reducing power consumption. For applications that require minimum ripple or fixed frequency, PFM mode can be disabled using the MODE pin.

The FAN5362 is available in 6-bump, 0.4mm pitch, Wafer-Level Chip-Scale Package (WLCSP) and 6-Lead 2 x 2mm Ultrathin Molded Leadless Package (UMLP).

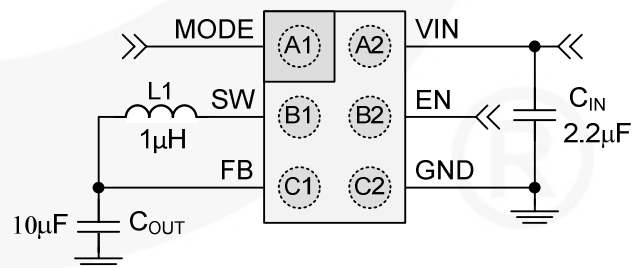

Figure 1. Typical Application

Trademarks are the property of their respective owners.

Ordering Information

Part Number	Output Voltage ⁽¹⁾	Operating Temperature Range	Package	Packing Method
FAN5362UC21X ⁽²⁾	2.1	-40 to 85°C	WLCSP-6, 0.4mm Pitch	Tape and Reel
FAN5362UC25X ⁽²⁾	2.5			
FAN5362UC27X ⁽²⁾	2.7			
FAN5362UC29X	2.9			
FAN5362UC33X	3.3			
FAN5362UMP29X	2.9		6-Lead, 2 x 2mm UMLP	
FAN5362UMP33X	3.3			

Note:

- Other voltage options available on request. Contact a Fairchild representative.
- Preliminary; not full production release at this time. Contact a Fairchild representative for information.

Table 1. Recommended Components for Circuit in Figure 1

Component	Description	Example Part	Typical
L1	1μH, 2012, 190mΩ, 800mA	Murata LQM21PN1R0MC0	1μH
C _{IN}	2.2μF, 6.3V, X5R, 0402	Murata GRM155R60J225ME15	2.2μF
	2.2μF, 6.3V, X5R, 0603	GRM188R60J225KE19D	
C _{OUT}	4.7μF, X5R, 0603	Murata GRM188R60J475M	4.7μF
	10μF, X5R, 0603	Murata GRM188R60J106ME47D	10.0μF

Pin Configuration

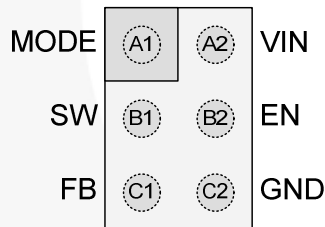

Figure 2. WLCSP, Bumps Facing Down

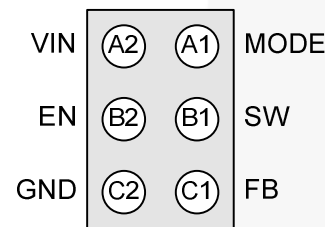

Figure 3. WLCSP, Bumps Facing Up

Pin Definitions

Pin #	Name	Description
A1	MODE	Logic 1 on this pin forces the IC to stay in PWM mode. A logic 0 allows the IC to automatically switch to PFM during light loads. The regulator also synchronizes its switching frequency to two times the frequency provided on this pin. Do not leave this pin floating.
B1	SW	Switching Node. Connect to output inductor.
C1	FB	Feedback / V_{OUT}. Connect to output voltage.
C2	GND	Ground. Power and IC ground. All signals are referenced to this pin.
B2	EN	Enable. The device is in shutdown mode when voltage to this pin is <0.4V and enabled when >1.2V. Do not leave this pin floating.
A2	VIN	Input Voltage. Connect to input power source.

Absolute Maximum Ratings

Stresses exceeding the absolute maximum ratings may damage the device. The device may not function or be operable above the recommended operating conditions and stressing the parts to these levels is not recommended. In addition, extended exposure to stresses above the recommended operating conditions may affect device reliability. The absolute maximum ratings are stress ratings only.

Symbol	Parameter	Min.	Max.	Unit
V_{IN}	Input Voltage	-0.3	6.5	V
V_{SW}	Voltage on SW Pin	-0.3	$V_{IN} + 0.3^{(3)}$	V
V_{CTRL}	EN and MODE Pin Voltage	-0.3	$V_{IN} + 0.3^{(3)}$	V
V_{FB}	FB Pin	-0.3	4	V
ESD	Electrostatic Discharge Protection Level	Human Body Model per JESD22-A114	3.0	kV
		Charged Device Model per JESD22-C101	1.5	
T_J	Junction Temperature	-40	+150	°C
T_{STG}	Storage Temperature	-65	+150	°C
T_L	Lead Soldering Temperature, 10 Seconds		+260	°C

Note:

3. Lesser of 6.5V or $V_{IN}+0.3V$.

Recommended Operating Conditions

The Recommended Operating Conditions table defines the conditions for actual device operation. Recommended operating conditions are specified to ensure optimal performance to the datasheet specifications. Fairchild does not recommend exceeding them or designing to Absolute Maximum Ratings.

Symbol	Parameter	Min.	Typ.	Max.	Unit
V_{CC}	Supply Voltage Range	2.7 ⁽⁴⁾		5.5	V
I_{OUT}	Output Current for 2.1V	0		750	mA
	Output Current for 2.5V, 2.7V, 2.9V, 3.3V	0		500	
L	Inductor		1		μH
C_{IN}	Input Capacitor		2.2		μF
C_{OUT}	Output Capacitor		10	24	μF
T_A	Operating Ambient Temperature	-40		+85	°C
T_J	Operating Junction Temperature	-40		+125	°C

Note:

4. Minimum $V_{IN} = V_{OUT} + 200mV$ or 2.7V, whichever is greater.

Thermal Properties

Junction-to-ambient thermal resistance is a function of application and board layout. This data is measured with four-layer 1s2p boards in accordance to JEDEC standard JESD51. Special attention must be paid not to exceed junction temperature $T_{J(max)}$ at a given ambient temperature T_A .

Symbol	Parameter	Typical	Unit
θ_{JA}	Junction-to-Ambient Thermal Resistance	WLSCP	150
		UMLP	49

Electrical Characteristics

Minimum and maximum values are at $V_{IN} = V_{EN} = 2.7V$ to $5.5V$, $V_{MODE} = 0V$ (AUTO Mode), $T_A = -40^\circ C$ to $+85^\circ C$; circuit of Figure 1, unless otherwise noted. Typical values are at $T_A = 25^\circ C$, $V_{IN} = V_{EN} = 3.6V$, $V_{MODE} = 0V$, $C_{OUT} = 10\mu F$.

Symbol	Parameter	Conditions	Min.	Typ.	Max.	Unit	
Power Supplies							
I_Q	Quiescent Current	No Load, Not Switching, $V_{IN} > 3V$		45	75	μA	
		PWM Mode		5		mA	
$I_{(SD)}$	Shutdown Supply Current	EN = GND		0.05	1.00	μA	
V_{UVLO}	Under-Voltage Lockout Threshold	Rising V_{IN}		2.5	2.6	V	
V_{UVHYS}	Under-Voltage Lockout Hysteresis			175		mV	
$V_{(ENH)}$	Enable HIGH-Level Input Voltage		1.05			V	
$V_{(ENL)}$	Enable LOW-Level Input Voltage				0.4	V	
$I_{(EN)}$	Enable Input Leakage Current	EN to V_{IN} or GND		0.01	1.00	μA	
$V_{(MH)}$	MODE HIGH-Level Input Voltage		1.05			V	
$V_{(ML)}$	MODE LOW-Level Input Voltage				0.4	V	
$I_{(M)}$	MODE Input Leakage Current	MODE to V_{IN} or GND		0.01	1.00	μA	
Switching and Synchronization							
f_{SW}	Switching Frequency ⁽⁵⁾	$V_{IN} = 3.6V$, $T_A = 25^\circ C$	2.7	3.0	3.3	MHz	
f_{SYNC}	MODE Synchronization Range ⁽⁵⁾	Square Wave at MODE Input	1.3	1.5	1.7	MHz	
Regulation							
V_O	Output Voltage Accuracy	2.10V	$I_{LOAD} = 0$ to 750mA	2.037 (-3%)	2.100	2.163 (+3%)	V
		2.50V	$I_{LOAD} = 0$ to 400mA, $V_{IN} \geq V_{OUT} + 200mV$	2.375 (-5%)	2.500	2.575 (+3%)	
			$I_{LOAD} = 0$ to 500mA, $V_{IN} \geq V_{OUT} + 300mV$	2.425 (-3%)	2.500	2.575 (+3%)	
		2.70V, 2.90V, 3.30V	$I_{LOAD} = 0$ to 400mA, $V_{IN} \geq V_{OUT} + 150mV$	-5%		+3%	
$I_{LOAD} = 0$ to 500mA, $V_{IN} \geq V_{OUT} + 300mV$	-3%			+3%			
t_{SS}	Soft-Start	From EN Rising Edge		180	300	μs	
Output Driver							
$R_{DS(on)}$	PMOS On Resistance	$V_{IN} = V_{GS} = 3.6V$		330		m Ω	
	NMOS On Resistance	$V_{IN} = V_{GS} = 3.6V$		300		m Ω	
$I_{LIM(OL)}$	PMOS Peak Current Limit ⁽⁵⁾	$V_{OUT} = 2.1V$		1375		mA	
		$V_{OUT} = 2.5V, 2.7V, 2.9V, 3.3V$	800	1000	1150	mA	
T_{TSD}	Thermal Shutdown			150		$^\circ C$	
T_{HYS}	Thermal Shutdown Hysteresis			15		$^\circ C$	

Notes:

- Limited by the effect of t_{OFF} minimum (see Figure 7 in Typical Performance Characteristics).
- The Electrical Characteristics table reflects open-loop data. Refer to the Operation Description and Typical Characteristics for closed-loop data.

Typical Characteristics

Unless otherwise noted, $V_{IN}=V_{EN}=3.6V$, $V_{MODE}=0$ (AUTO), $V_{OUT}=2.9V$, $C_{OUT}=10\mu F$, and $T_A=25^\circ C$.

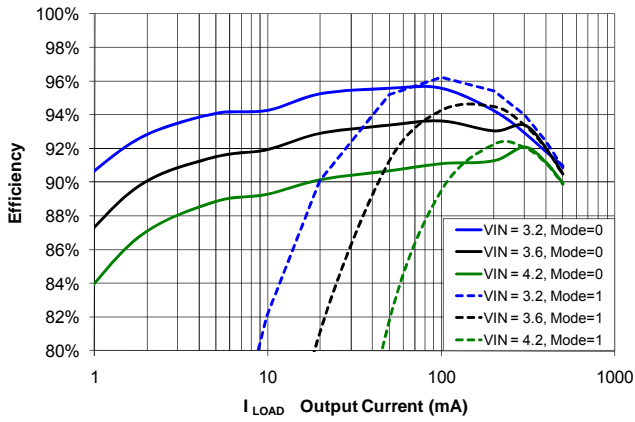

Figure 4. Efficiency vs. Load Current and Input Supply

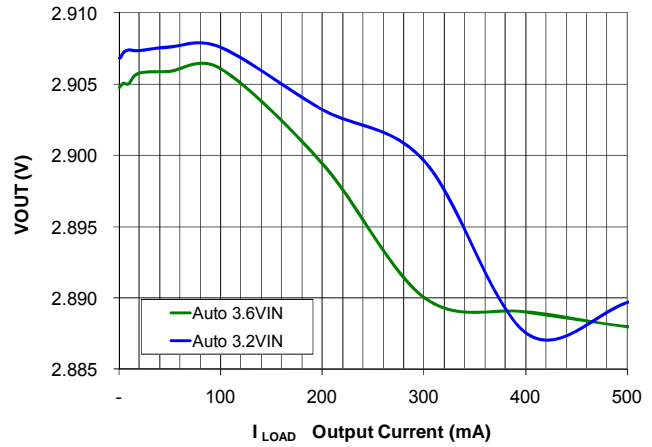

Figure 5. Load Regulation

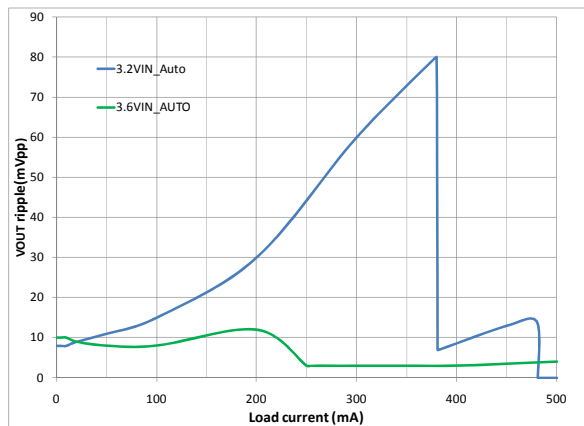

Figure 6. Ripple

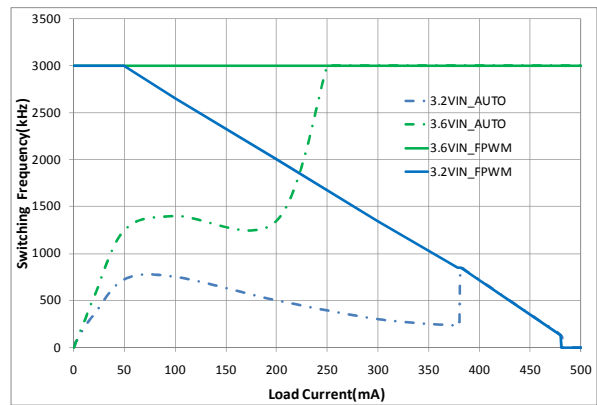

Figure 7. Effect of $t_{OFF(MIN)}$ on Reducing Switching Frequency

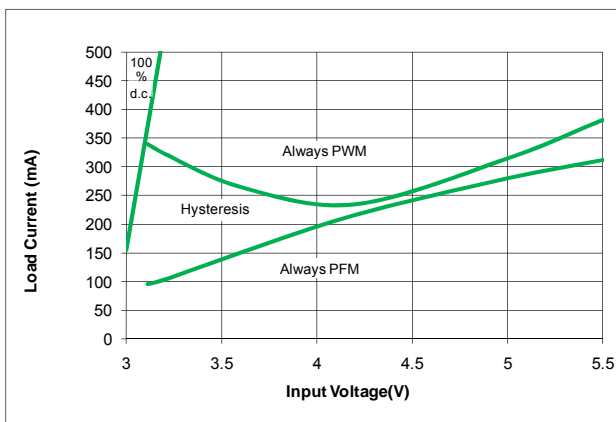

Figure 8. PFM / PWM Boundaries

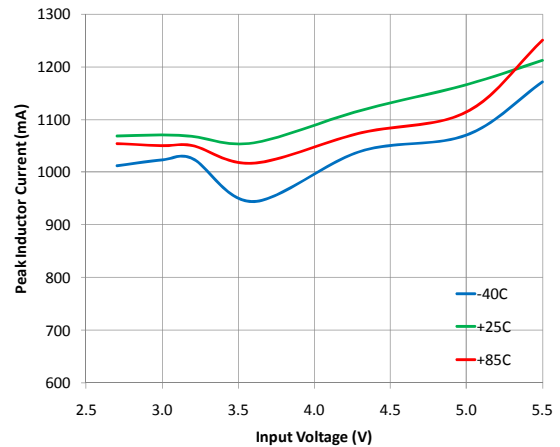

Figure 9. Peak Inductor Current

Typical Characteristics

Unless otherwise noted, $V_{IN}=V_{EN}=3.6V$, $V_{MODE}=0$ (AUTO), $V_{OUT}=2.9V$, $C_{OUT}=10\mu F$, and $T_A=25^\circ C$.

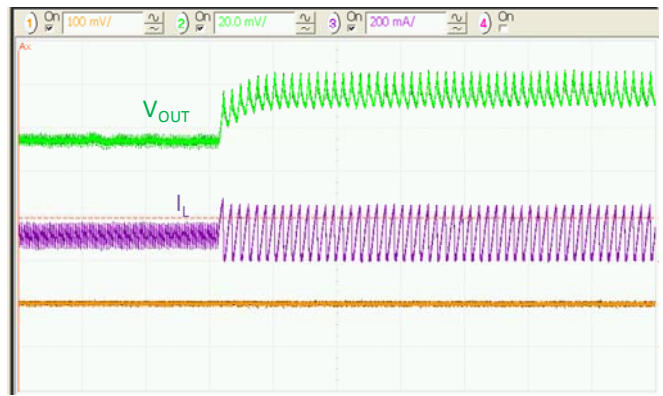
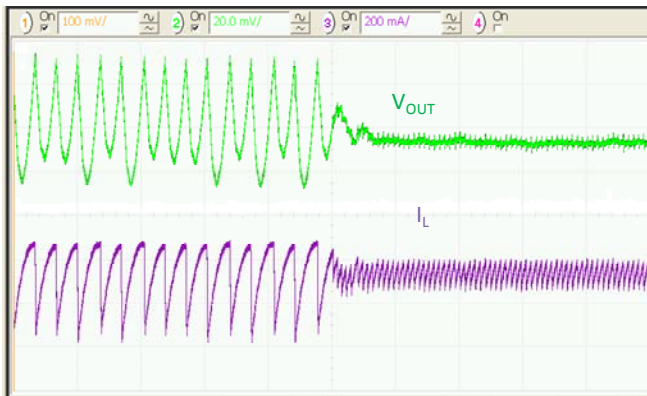

Figure 10. PFM to PWM Transition at $V_{IN}=3.2V$, $10\mu s/div$. Figure 11. PWM to PFM Transition at $V_{IN}=3.2V$, $10\mu s/div$.

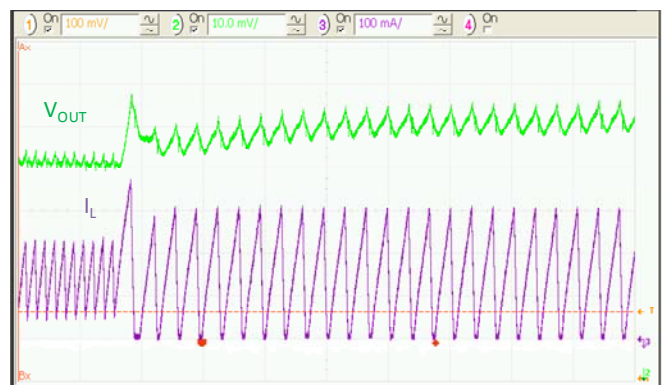
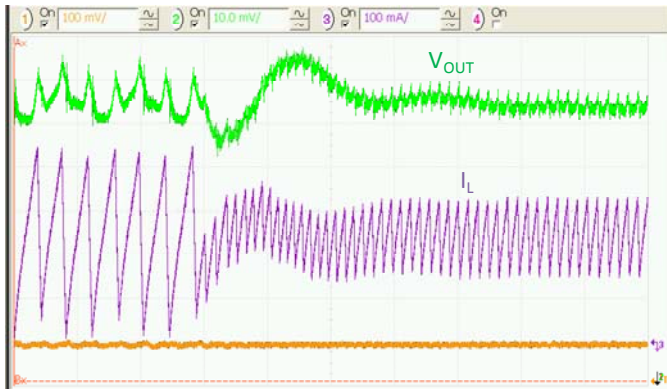

Figure 12. PFM to PWM Transition at $V_{IN}=3.6V$, $2\mu s/div$. Figure 13. PWM to PFM Transition at $V_{IN}=3.6V$, $2\mu s/div$.

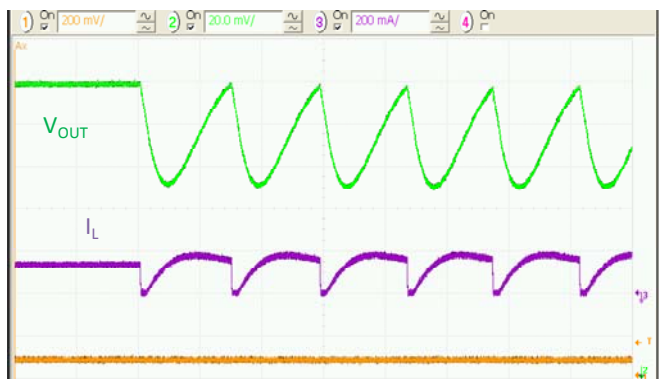
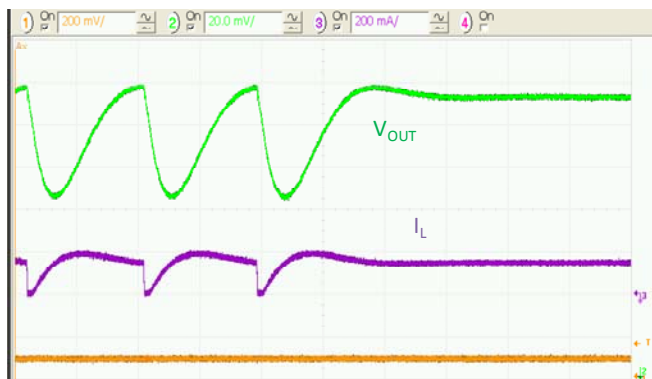

Figure 14. Regular Switching to 100% Duty Cycle Transition at $V_{IN}=3.2V$, $5\mu s/div$.

Figure 15. 100% Duty Cycle to Regular Switching Transition at $V_{IN}=3.2V$, $5\mu s/div$.

Typical Characteristics

Unless otherwise noted, $V_{IN}=V_{EN}=3.6V$, $V_{MODE}=0$ (AUTO), $V_{OUT}=2.9V$, $C_{OUT}=10\mu F$, and $T_A=25^\circ C$.

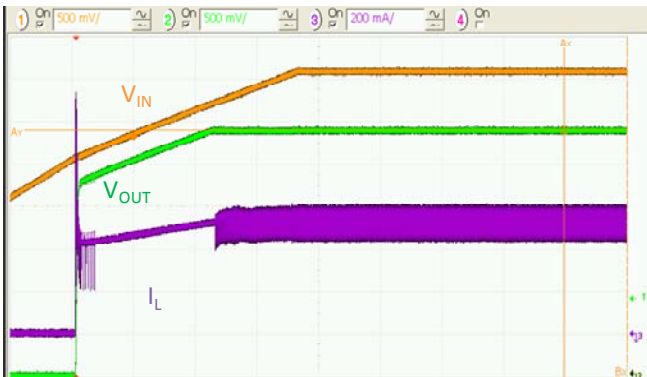

Figure 16. Startup Ramping $V_{IN}=V_{EN}$ with 500mA Load, 1ms/div.



Figure 17. Startup and Shutdown through V_{EN} with 500mA Load, 50µs/div.

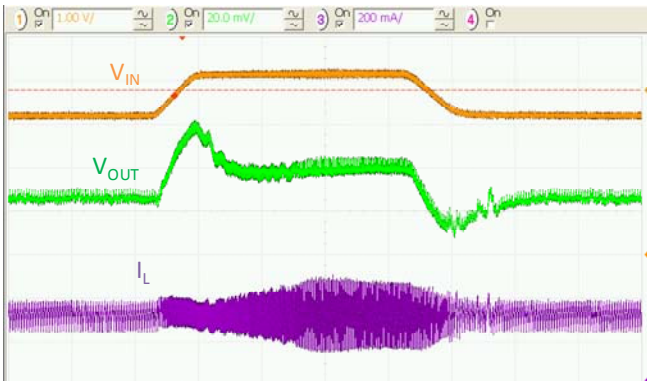

Figure 18. Line Transient at $V_{IN}=3.2V$ to $4.2V$, 300mA Load, $t_{RISE}=t_{FALL}=10\mu s$, 20µs/div.

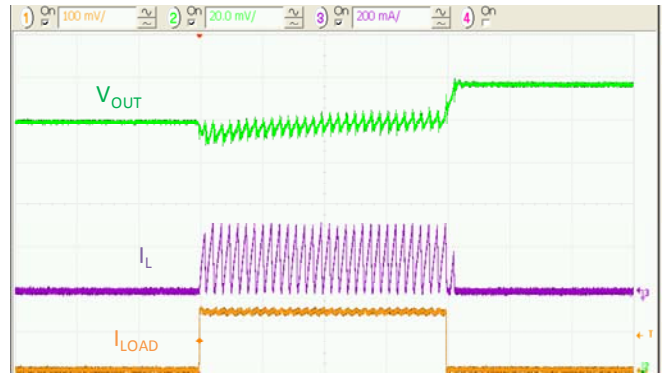

Figure 19. Load Transient 0mA to 150mA, $V_{IN}=3.6V$, $t_{RISE}=t_{FALL}=100ns$, 5µs/div.

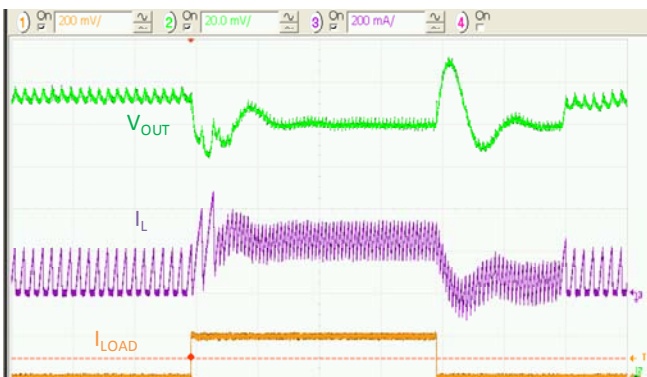

Figure 20. Load Transient 50mA to 250mA, $V_{IN}=3.6V$, $t_{RISE}=t_{FALL}=100ns$, 5µs/div.



Figure 21. Load Transient 150mA to 400mA, $V_{IN}=3.6V$, $t_{RISE}=t_{FALL}=100ns$, 5µs/div.

Typical Characteristics

Unless otherwise noted, $V_{IN}=V_{EN}=3.6V$, $V_{MODE}=0$ (AUTO), $V_{OUT}=2.9V$, $C_{OUT}=10\mu F$, and $T_A=25^\circ C$.

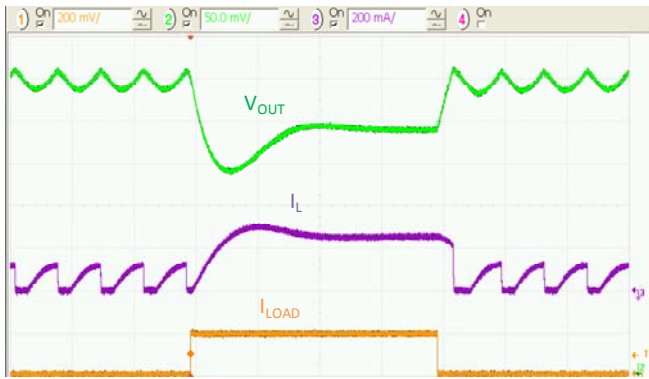

Figure 22. Load Transient 50mA to 250mA, $V_{IN}=3V$, $t_{RISE}=t_{FALL}=100ns$, $5\mu s/div$.



Figure 23. Load Transient 150mA to 400mA, $V_{IN}=3V$, $t_{RISE}=t_{FALL}=100ns$, $5\mu s/div$.

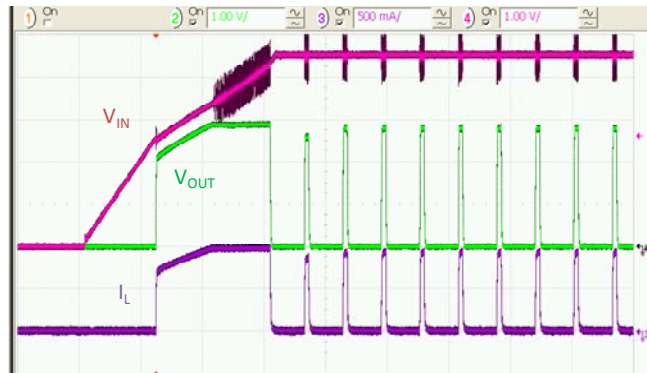

Figure 24. Startup Ramping $V_{IN}=V_{EN}$, into Overload, Load= 3Ω , $5ms/div$.

Operation Description

FAN5362 is a 500mA or 750mA, step-down switching voltage regulator that delivers a fixed output voltage from an input voltage supply up to 5.5V. Using a proprietary architecture with synchronous rectification, FAN5362 is capable of delivering a peak efficiency above 96%, while maintaining efficiency above 90% at load currents as low as 1mA. The regulator operates at a nominal frequency of 3MHz at full load, which reduces the value of the external components to 1μH for the inductor and 4.7μF for the output capacitor. High efficiency is maintained at light load with single-pulse PFM mode.

Control Scheme

The FAN5362 uses a proprietary, non-linear, fixed-frequency PWM modulator to deliver a fast load transient response, while maintaining a constant switching frequency over a wide range of operating conditions. The regulator performance is independent of the output capacitor ESR, allowing for the use of ceramic output capacitors. Although this type of operation normally results in a switching frequency that varies with input voltage and load current, an internal frequency loop holds the switching frequency constant over a large range of input voltages and load currents.

For very light loads, the FAN5362 operates in discontinuous current (DCM) single-pulse PFM mode, which produces low output ripple compared with other PFM architectures. Transition between PWM and PFM is seamless, with a glitch of less than 18mV at V_{OUT} during the transition between DCM and CCM modes.

Combined with exceptional transient response characteristics, the very low quiescent current of the controller (45μA) maintains high efficiency, even at very light loads, while preserving fast transient response for applications requiring tight output regulation.

100% Duty Cycle Operation

When V_{IN} approaches V_{OUT} , the regulator increases its duty cycle until 100% duty cycle is reached. As the duty cycle approaches 100%, the switching frequency declines due to the minimum off-time ($t_{OFF(MIN)}$) of about 35ns imposed by the control circuit. When 100% duty cycle is reached, V_{OUT} follows V_{IN} with a drop-out voltage ($V_{DROPOUT}$) determined by the total resistance between V_{IN} and V_{OUT} :

$$V_{DROPOUT} = I_{LOAD} \cdot (PMOS R_{DS(ON)} + DCR_L) \quad (1)$$

To calculate the worst-case $V_{DROPOUT}$, use the maximum PMOS $R_{DS(ON)}$ at high temperature from Figure 5.

Enable and Soft Start

When the EN pin is LOW, the IC is shut down and the part draws very little current. In addition, during shutdown, FB is actively discharged to ground through a 230Ω path. Raising EN above its threshold voltage activates the part and starts the soft-start cycle. During soft-start, the internal reference is ramped using an exponential RC shape to prevent any overshoot of the output voltage. Current limiting minimizes inrush during soft-start.

Synchronous rectification is inhibited during soft-start, allowing the IC to start into a pre-charged load.

The IC may fail to start if heavy load is applied during startup and/or if excessive C_{OUT} is used. This is due to the current-limit fault response, which protects the IC in the event of an over-current condition present during soft-start.

The current required to charge C_{OUT} during soft-start is commonly referred to as “displacement current” and given as:

$$I_{DISP} = C_{OUT} \cdot \frac{dV}{dt} \quad (2)$$

where $\frac{dV}{dt}$ refers to the soft-start slew rate.

To prevent shutdown during soft-start, the following condition must be met:

$$I_{DISP} + I_{LOAD} < I_{MAX(DC)} \quad (3)$$

where $I_{MAX(DC)}$ is the maximum load current the IC is guaranteed to support (500mA or 750mA).

MODE Pin

Logic 1 on this pin forces the IC to stay in PWM mode. A logic 0 allows the IC to automatically switch to PFM during light loads. If the MODE pin is toggled, the converter synchronizes its switching frequency to four times the frequency on the mode pin (f_{MODE}).

At startup, the mode pin must be held LOW or HIGH for at least 10μs to ensure that the converter does not attempt to synchronize to this pin.

Under-Voltage Lockout

When EN is HIGH, the under-voltage lockout keeps the part from operating until the input supply voltage rises high enough to properly operate. This ensures no misbehavior of the regulator during startup or shutdown.

Current Limiting

A heavy load or short circuit on the output causes the current in the inductor to increase until a maximum current threshold is reached in the high-side switch. Upon reaching this point, the high-side switch turns off, preventing high currents from causing damage. 16 consecutive PWM cycles in current limit causes the regulator to shut down and stay off for about 2900μs before attempting a restart.

In the event of a short circuit, the soft-start circuit attempts to restart at 240μs, which results in a duty cycle of less than 10%, providing current into a short.

The closed-loop peak-current limit, $I_{LIM(PK)}$, is not the same as the open-loop tested current limit, $I_{LIM(OL)}$, in the Electrical Characteristics table. This is primarily due to the effect of propagation delays of the IC current limit comparator.

Thermal Shutdown

When the die temperature increases, due to a high load condition and/or a high ambient temperature, the output switching is disabled until the temperature on the die has fallen sufficiently. The junction temperature at which the thermal shutdown activates is nominally 150°C with a 20°C hysteresis.

Minimum Off-Time Effect on Switching Frequency

$t_{OFF(MIN)}$ is 35ns. This imposes constraints on the maximum $\frac{V_{OUT}}{V_{IN}}$ that the FAN5362 can provide, or the maximum output voltage it can provide at low V_{OUT} while maintaining a fixed switching frequency in PWM mode.

When V_{IN} is high, fixed switching is maintained as long as $\frac{V_{OUT}}{V_{IN}} \leq 1 - t_{OFF(MIN)} \cdot f_{SW} \approx 0.7$.

The switching frequency drops when the regulator cannot provide sufficient duty cycle at 3MHz to maintain regulation. This occurs when V_{IN} is below 3.3V at nominal load currents.

The calculation for switching frequency is given by:

$$f_{SW} = \min\left(\frac{1}{t_{SW(MAX)}}, 3\text{MHz}\right) \quad (4)$$

where:

$$t_{SW(MAX)} = 35\text{ns} \cdot \left(1 + \frac{V_{OUT} + I_{OUT} \cdot R_{OFF}}{V_{IN} - I_{OUT} \cdot R_{ON} - V_{OUT}}\right) \quad (5)$$

where:

$$R_{OFF} = R_{DSON_N} + DCR_L$$

$$R_{ON} = R_{DSON_P} + DCR_L$$

Applications Information

Selecting the Inductor

The output inductor must meet both the required inductance and the energy handling capability of the application.

The inductor value affects the average current limit, the PWM-to-PFM transition point, the output voltage ripple, and the efficiency.

The ripple current (ΔI) of the regulator is:

$$\Delta I \approx \frac{V_{OUT}}{V_{IN}} \cdot \left(\frac{V_{IN} - V_{OUT}}{L \cdot f_{SW}}\right) \quad (6)$$

The maximum average load current, $I_{MAX(Load)}$ is related to the peak current limit, $I_{LIM(PK)}$ by the ripple current:

$$I_{MAX(Load)} = I_{LIM(PK)} - \frac{\Delta I}{2} \quad (7)$$

The FAN5362 is optimized for operation with $L=1\mu\text{H}$, but is stable with inductances up to 1.5 μH (nominal) and down to 470nH. The inductor should be rated to maintain at least 80% of its value at $I_{LIM(PK)}$. Failure to do so lowers the amount of DC current that the IC can deliver.

Efficiency is affected by the inductor DCR and inductance value. Decreasing the inductor value for a given physical size typically decreases the DCR; but since ΔI increases, the RMS current increases, as do the core and skin effect losses.

$$I_{RMS} = \sqrt{I_{OUT(DC)}^2 + \frac{\Delta I^2}{12}} \quad (8)$$

The increased RMS current produces higher losses through the $R_{DS(ON)}$ of the IC MOSFETs as well as the inductor ESR.

Increasing the inductor value produces lower RMS currents, but degrades transient response. For a given physical inductor size, increased inductance usually results in an inductor with lower saturation current and higher DCR.

Inductor Current Rating

The FAN5362's current limit circuit can allow a peak current of 1.25A to flow through L1 under worst-case conditions. If it is possible for the load to draw that much continuous current, the inductor should be capable of sustaining that current or failing in a safe manner.

Output Capacitor

While 4.7 μF capacitors are available in 0402 package size, 0603 capacitors are recommended due to the severe DC voltage bias degradation in capacitance value that the 0402 exhibits.

Increasing C_{OUT} has no effect on loop stability and can therefore be increased to reduce output voltage ripple or to improve transient response. Output voltage ripple, ΔV_{OUT} , is:

$$\Delta V_{OUT} = \Delta I \cdot \left(\frac{1}{8 \cdot C_{OUT} \cdot f_{SW}} + ESR\right) \quad (9)$$

If values greater than 24 μF of C_{OUT} are used, the regulator may fail to start. See the sections on *Enable and Soft Start* for more information.

Input Capacitor

The 2.2 μF ceramic input capacitor should be placed as close as possible to the V_{IN} pin and GND to minimize the parasitic inductance. If a long wire is used to bring power to the IC, additional "bulk" capacitance (electrolytic or tantalum) should be placed between C_{IN} and the power source lead to reduce ringing that can occur between the inductance of the power source leads and C_{IN} .

PCB Layout Guidelines

There are only three external components: the inductor, input capacitor, and the output capacitor. For any buck switcher IC, including the FAN5362, it is important to place a low-ESR input capacitor very close to the IC, as shown in Figure 25. The input capacitor ensures good input decoupling, which helps reduce noise appearing at the output terminals and ensures that the control sections of the IC do not behave erratically due to excessive noise. This reduces switching cycle jitter and ensures good overall performance. It is important to place the common GND of C_{IN} and C_{OUT} as close as possible to the C2 terminal. There is some flexibility in moving the inductor further away from the IC; in that case, V_{OUT} should be considered at the C_{OUT} terminal.

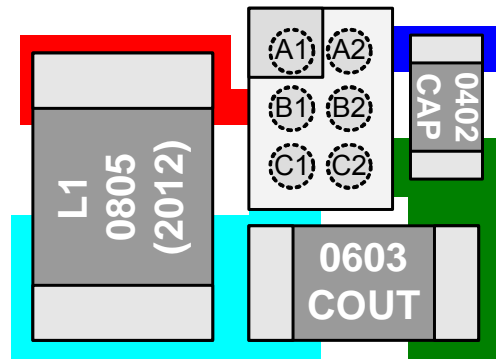

Figure 25. PCB Layout Recommendation



Physical Dimensions

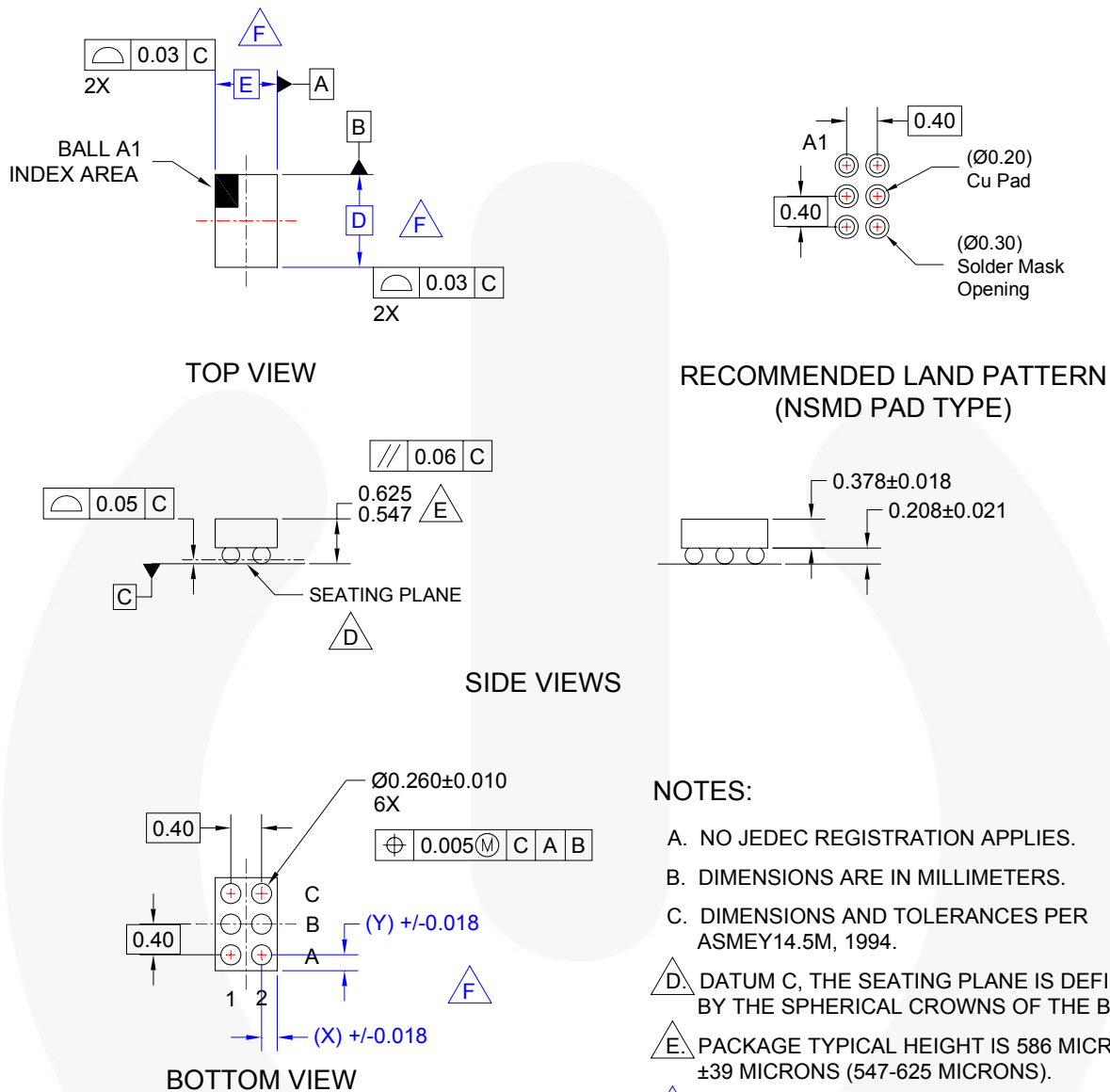

Figure 26. 6-Ball, Wafer-Level Chip-Scale Package (WLCSP), 2x3 Array, 0.4mm Pitch, 250µm Ball

Product-Specific Dimensions

Product	D	E	X	Y
FAN5362UCX	1.310 +/-0.030	0.960 +/-0.030	0.280	0.255

Package drawings are provided as a service to customers considering Fairchild components. Drawings may change in any manner without notice. Please note the revision and/or date on the drawing and contact a Fairchild Semiconductor representative to verify or obtain the most recent revision. Package specifications do not expand the terms of Fairchild's worldwide terms and conditions, specifically the warranty therein, which covers Fairchild products.

Always visit Fairchild Semiconductor's online packaging area for the most recent package drawings:
<http://www.fairchildsemi.com/packaging/>.

Physical Dimensions

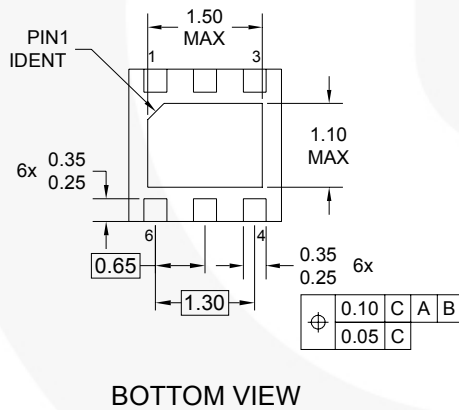
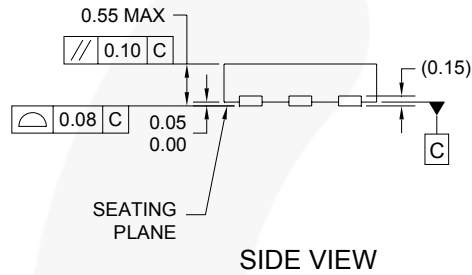
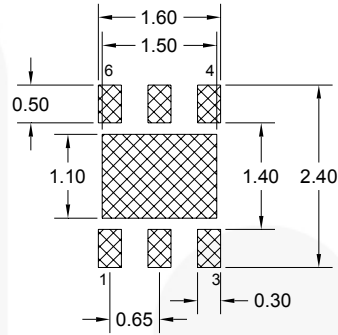
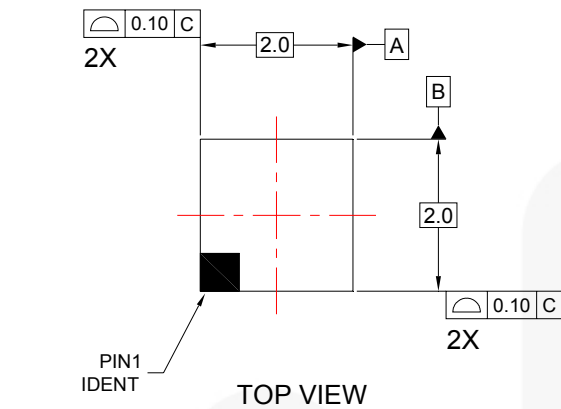

NOTES:

- A. OUTLINE BASED ON JEDEC REGISTRATION MO-229, VARIATION VCCC.
- B. DIMENSIONS ARE IN MILLIMETERS.
- C. DIMENSIONS AND TOLERANCES PER ASME Y14.5M, 1994.
- D. DRAWING FILENAME: MKT-UMLP06Crev1

6-Lead, 2 x 2mm, Ultra-Thin Molded Leadless Package (UMLP)





Package drawings are provided as a service to customers considering Fairchild components. Drawings may change in any manner without notice. Please note the revision and/or date on the drawing and contact a Fairchild Semiconductor representative to verify or obtain the most recent revision. Package specifications do not expand the terms of Fairchild's worldwide terms and conditions, specifically the warranty therein, which covers Fairchild products.

Always visit Fairchild Semiconductor's online packaging area for the most recent package drawings:
<http://www.fairchildsemi.com/packaging/>



TRADEMARKS

The following includes registered and unregistered trademarks and service marks, owned by Fairchild Semiconductor and/or its global subsidiaries, and is not intended to be an exhaustive list of all such trademarks.

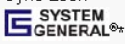
- | | | | |
|---|---|---|---|
| AccuPower™ | F-PFS™ | PowerTrench® | The Power Franchise® |
| Auto-SPM™ | FRFET® | PowerXS™ | The Right Technology for Your Success™ |
| Build it Now™ | Global Power Resource™ | Programmable Active Droop™ | the power franchise |
| CorePLUS™ | Green FPS™ | QFET® | TinyBoost™ |
| CorePOWER™ | Green FPS™ e-Series™ | QS™ | TinyBuck™ |
| CROSSVOLT™ | Gmax™ | Quiet Series™ | TinyCalc™ |
| CTL™ | GTO™ | RapidConfigure™ | TinyLogic® |
| Current Transfer Logic™ | IntelliMAX™ |  | TINYOPTO™ |
| DEUXPEED® | ISOPLANAR™ | Saving our world, 1mW/W/kW at a time™ | TinyPower™ |
| Dual Cool™ | MegaBuck™ | SignalWise™ | TinyPWM™ |
| EcoSPARK® | MICROCOUPLER™ | SmartMax™ | TinyWire™ |
| EfficientMax™ | MicroFET™ | SMART START™ | TriFault Detect™ |
| ESBC™ | MicroPak™ | SPM® | TRUECURRENT™* |
|  | MicroPak2™ | STEALTH™ | μSerDes™ |
| Fairchild® | MillerDrive™ | SuperFET® |  |
| Fairchild Semiconductor® | MotionMax™ | SuperSOT™-3 | UHC® |
| FACT Quiet Series™ | Motion-SPM™ | SuperSOT™-6 | Ultra FRFET™ |
| FACT® | OptoHIT™ | SuperSOT™-8 | UniFET™ |
| FAST® | OPTOLOGIC® | SupreMOS® | VCX™ |
| FastvCore™ | OPTOPLANAR® | SyncFET™ | VisualMax™ |
| FETBench™ |  | Sync-Lock™ | XS™ |
| FlashWriter® | PDP SPM™ |  | |
| FPS™ | Power-SPM™ | | |

* Trademarks of System General Corporation, used under license by Fairchild Semiconductor.

DISCLAIMER

FAIRCHILD SEMICONDUCTOR RESERVES THE RIGHT TO MAKE CHANGES WITHOUT FURTHER NOTICE TO ANY PRODUCTS HEREIN TO IMPROVE RELIABILITY, FUNCTION, OR DESIGN. FAIRCHILD DOES NOT ASSUME ANY LIABILITY ARISING OUT OF THE APPLICATION OR USE OF ANY PRODUCT OR CIRCUIT DESCRIBED HEREIN; NEITHER DOES IT CONVEY ANY LICENSE UNDER ITS PATENT RIGHTS, NOR THE RIGHTS OF OTHERS. THESE SPECIFICATIONS DO NOT EXPAND THE TERMS OF FAIRCHILD'S WORLDWIDE TERMS AND CONDITIONS, SPECIFICALLY THE WARRANTY THEREIN, WHICH COVERS THESE PRODUCTS.

LIFE SUPPORT POLICY

FAIRCHILD'S PRODUCTS ARE NOT AUTHORIZED FOR USE AS CRITICAL COMPONENTS IN LIFE SUPPORT DEVICES OR SYSTEMS WITHOUT THE EXPRESS WRITTEN APPROVAL OF FAIRCHILD SEMICONDUCTOR CORPORATION.

As used herein:

1. Life support devices or systems are devices or systems which, (a) are intended for surgical implant into the body or (b) support or sustain life, and (c) whose failure to perform when properly used in accordance with instructions for use provided in the labeling, can be reasonably expected to result in a significant injury of the user.
2. A critical component in any component of a life support, device, or system whose failure to perform can be reasonably expected to cause the failure of the life support device or system, or to affect its safety or effectiveness.

ANTI-COUNTERFEITING POLICY

Fairchild Semiconductor Corporation's Anti-Counterfeiting Policy. Fairchild's Anti-Counterfeiting Policy is also stated on our external website, www.fairchildsemi.com, under Sales Support.

Counterfeiting of semiconductor parts is a growing problem in the industry. All manufacturers of semiconductor products are experiencing counterfeiting of their parts. Customers who inadvertently purchase counterfeit parts experience many problems such as loss of brand reputation, substandard performance, failed applications, and increased cost of production and manufacturing delays. Fairchild is taking strong measures to protect ourselves and our customers from the proliferation of counterfeit parts. Fairchild strongly encourages customers to purchase Fairchild parts either directly from Fairchild or from Authorized Fairchild Distributors who are listed by country on our web page cited above. Products customers buy either from Fairchild directly or from Authorized Fairchild Distributors are genuine parts, have full traceability, meet Fairchild's quality standards for handling and storage and provide access to Fairchild's full range of up-to-date technical and product information. Fairchild and our Authorized Distributors will stand behind all warranties and will appropriately address any warranty issues that may arise. Fairchild will not provide any warranty coverage or other assistance for parts bought from Unauthorized Sources. Fairchild is committed to combat this global problem and encourage our customers to do their part in stopping this practice by buying direct or from authorized distributors.

PRODUCT STATUS DEFINITIONS

Definition of Terms

Datasheet Identification	Product Status	Definition
Advance Information	Formative / In Design	Datasheet contains the design specifications for product development. Specifications may change in any manner without notice.
Preliminary	First Production	Datasheet contains preliminary data; supplementary data will be published at a later date. Fairchild Semiconductor reserves the right to make changes at any time without notice to improve design.
No Identification Needed	Full Production	Datasheet contains final specifications. Fairchild Semiconductor reserves the right to make changes at any time without notice to improve the design.
Obsolete	Not In Production	Datasheet contains specifications on a product that is discontinued by Fairchild Semiconductor. The datasheet is for reference information only.

Rev. I51