

Spezifikation für Freigabe / specification for release

Kunde / customer :

Artikelnummer / part number : **744272121**



Bezeichnung : **STROMKOMP. SMD LINE FILTER WE-SL5**
 description : **COMMON MODE SMD LINE FILTER WE-SL5**

DATUM/DATE: 2008-01-14

A Mechanische Abmessungen / dimensions:

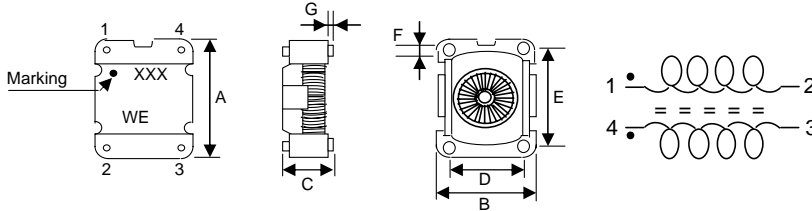

A	10,0 ± 0,3	mm
B	8,70 ± 0,3	mm
C	6,50 max.	mm
D	6,22 ± 0,1	mm
E	7,62 ± 0,1	mm
F	1,25 ± 0,1	mm
G	0,30 min.	mm

B Elektrische Eigenschaften / electrical properties:

Eigenschaften / properties	Testbedingungen / test conditions		Wert / value	Einheit / unit	tol.
Induktivität / inductance	0,1V / 100KHz	L _{1-2,4-3}	120	μH	±40%
DC-Widerstand / DC-resistance		R _{DC}	0,025	Ω	max.
Nennstrom / rated current	ΔT= 40K	I _{DC}	2500	mA	max.
Impedanz / impedance		Z _{com}	460	Ω	max.
Nennspannung / rated voltage		U _{DC}	80	V	max.

C Lötpad / soldering spec.:

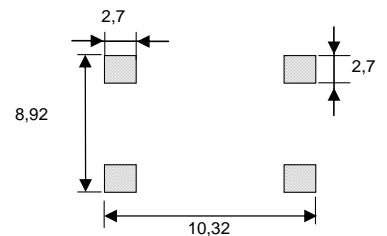

D Prüfgeräte / test equipment:

HP 4191 B für/for Z und/and material
HP 34401 A für/for R_{DC} und/and IDC

E Testbedingungen / test conditions:

Luftfeuchtigkeit / humidity: **33%**
 Umgebungstemperatur / temperature: **+20°C**
 Spannungsfestigkeit / High-Pot Test (60Hz;1mA;1min.) **1000VAC**

F Werkstoffe & Zulassungen / material & approvals:

Basismaterial / base material: **Ferrit/ ferrite**
 Draht / wire: **2-SFBW / 155°C**
 Gehäuse / Housing: **UL94-V0**

G Eigenschaften / general specifications:

Betriebstemp. / operating temperature: **-40°C - +125°C**
 Umgebungstemp. / ambient temperature: **-40°C - +85°C**
 It is recommended that the temperature of the part does not exceed 125°C under worst case operating conditions.

Freigabe erteilt / general release:	Kunde / customer		
Datum / date	Unterschrift / signature		
Geprüft / checked	Würth Elektronik		
	Name	Änderung / modification	Datum / date
	SSt	Version 4	08-01-14
	MST	Version 3	06-05-09
	MST	Version 2	04-10-11
	ME	Version 1	04-04-26

Würth Elektronik eiSos GmbH & Co. KG

D-74638 Waldenburg · Max-Eyth-Strasse 1 - 3 · Germany · Telefon (+49) (0) 7942 - 945 - 0 · Telefax (+49) (0) 7942 - 945 - 400
<http://www.we-online.com>

Spezifikation für Freigabe / specification for release

Kunde / customer : _____
 Artikelnummer / part number : **744272121**
 Bezeichnung : **STROMKOMP. SMD LINE FILTER WE-SL5**
 description : **COMMON MODE SMD LINE FILTER WE-SL5**



DATUM/DATE: 2008-01-14

H Impedanzverlauf / impedance curve:

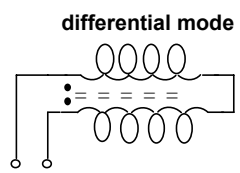
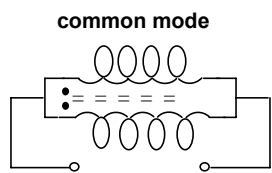
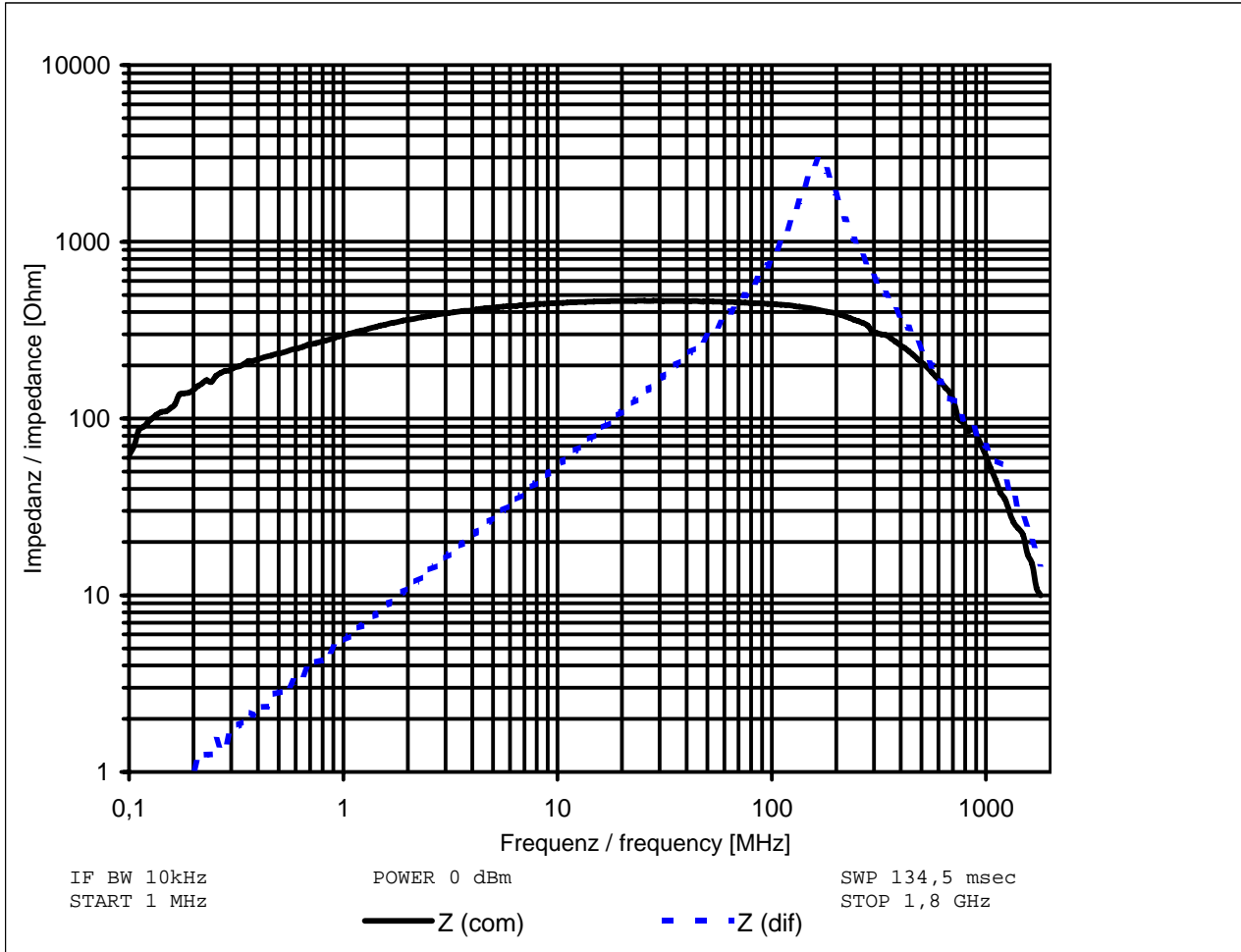

Freigabe erteilt / general release:	Kunde / customer			
.....			
Datum / date	Unterschrift / signature	SSt	Version 4	08-01-14
	Würth Elektronik	MST	Version 3	06-05-09
.....	MST	Version 2	04-10-11
Geprüft / checked	Kontrolliert / approved	ME	Version 1	04-04-26
		Name	Änderung / modification	Datum / date

Würth Elektronik eiSos GmbH & Co. KG

D-74638 Waldenburg · Max-Eyth-Strasse 1 - 3 · Germany · Telefon (+49) (0) 7942 - 945 - 0 · Telefax (+49) (0) 7942 - 945 - 400
<http://www.we-online.com>

Spezifikation für Freigabe / specification for release

Kunde / customer : _____
 Artikelnummer / part number : **744272121**
 Bezeichnung : **STROMKOMP. SMD LINE FILTER WE-SL5**
 description : **COMMON MODE SMD LINE FILTER WE-SL5**



DATUM/DATE: 2008-01-14

I Rollenspezifikation / tape and reel specification:

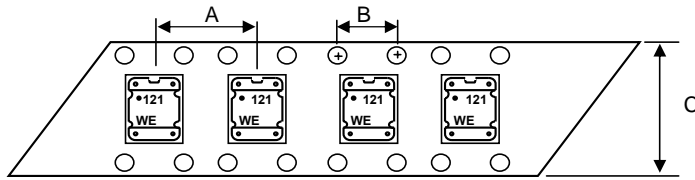

Gurtspezifikation / Tape specification:

A	12	mm
B	4	mm
C	24	mm
D		mm
E		mm
F		mm
G		mm
H		mm
I		mm
J		mm
T		mm

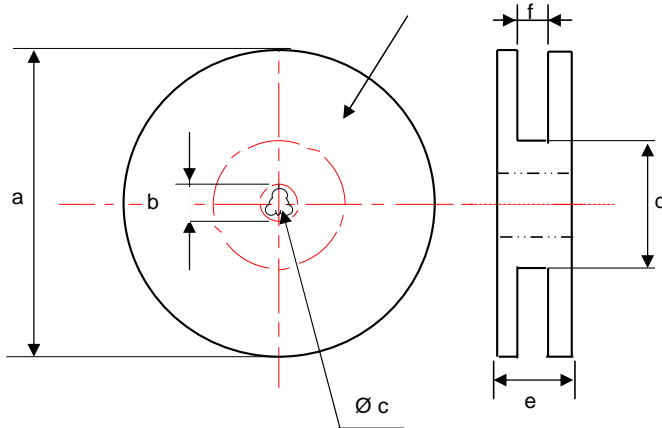

Rollenspezifikation / Reel specification:

a	330 ± 2,0	mm
b	21 ± 0,8	mm
c	13 ± 0,5	mm
d	50 ± 1,0	mm
e	30,4	mm
f	26	mm

165 to 180°

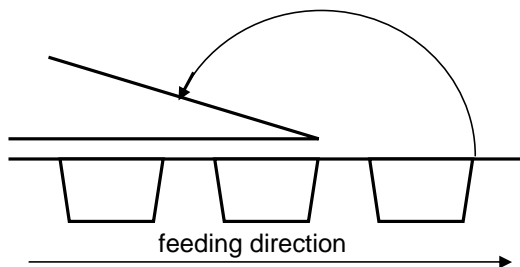

The force for tearing off cover tape is 10 to 130 grams in arrow direction

Freigabe erteilt / general release:	Kunde / customer		
Datum / date	Unterschrift / signature		
	Würth Elektronik		
Geprüft / checked	Kontrolliert / approved		
	Name	Änderung / modification	Datum / date

This electronic component has been designed and developed for usage in general electronic equipment. Before incorporating this component into any equipment where higher safety and reliability is especially required or if there is the possibility of direct damage or injury to human body, for example in the range of aerospace, aviation, nuclear control, submarine, transportation, (automotive control, train control, ship control), transportation signal, disaster prevention, medical, public information network etc, Würth Elektronik eiSos GmbH must be informed before the design-in stage. In addition, sufficient reliability evaluation checks for safety must be performed on every electronic component which is used in electrical circuits that require high safety and reliability functions or performance.

Würth Elektronik eiSos GmbH & Co. KG

D-74638 Waldenburg · Max-Eyth-Strasse 1 - 3 · Germany · Telefon (+49) (0) 7942 - 945 - 0 · Telefax (+49) (0) 7942 - 945 - 400
<http://www.we-online.com>