

**PLEASE CHECK WWW.MOLEX.COM FOR LATEST PART INFORMATION**

**Part Number:** [0749525006](#)  
**Status:** **Active**  
**Overview:** vhdm\_hsd  
**Description:** 2.00mm (.079") Pitch 5-Row VHDM-HSD™ Backplane Header, Polarizing Pin Module, Code Key F, 40 Circuits

**Documents:**

[Drawing \(PDF\)](#) [RoHS Certificate of Compliance \(PDF\)](#)  
[Product Specification PS-74031-999 \(PDF\)](#)

**General**

Product Family	Backplane Connectors
Series	<a href="#">74952</a>
Application	Backplane
Application Tooling Documents	<a href="http://www.molex.com/pdm_docs/ats/TM-622010999.pdf">Tooling Manual</a>
Comments	Position F, PCB Thickness 1.80mm (.070") to 4.00mm (.157")
Component Type	PCB Header
Overview	<a href="#">vhdm_hsd</a>
Product Name	VHDM-HSD™
Style	N/A

**Physical**

Circuits (Loaded)	N/A
Durability (mating cycles max)	200
First Mate / Last Break	No
Guide to Mating Part	Yes
Keying to Mating Part	Yes
Material - Metal	Stainless Steel
Number of Columns	6
Number of Pairs	Open Pin Field
Number of Rows	0
Orientation	Vertical
PCB Locator	No
PCB Retention	None
PCB Thickness Recommended (in)	0.071 In
PCB Thickness Recommended (mm)	1.80 mm
Packaging Type	Bag
Pitch - Mating Interface (in)	0.000 In
Pitch - Mating Interface (mm)	0.00 mm
Polarized to PCB	Yes
Surface Mount Compatible (SMC)	Yes
Temperature Range - Operating	N/A

**Electrical**

Current - Maximum per Contact	N/A
Data Rate	5.0 Gbps
Shield Type	N/A
Shielded	No
Voltage - Maximum	N/A

**Material Info**

**Reference - Drawing Numbers**

Product Specification	PS-74031-999
Sales Drawing	SD-74952-002

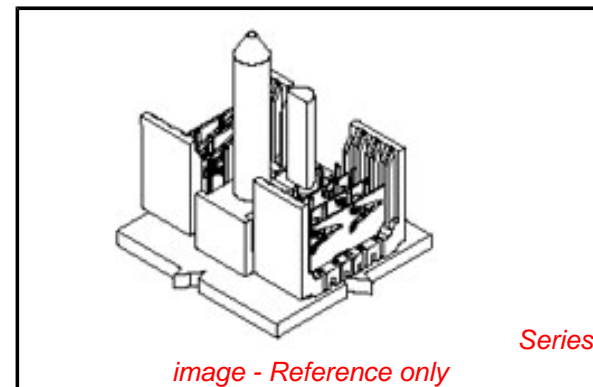

*image - Reference only*

**EU RoHS** **China RoHS**

**Compliance Status**

**Not Reviewed**

**REACH SVHC**

Not Reviewed

**Halogen-Free**

**Status**

**Not Reviewed**

**Need more information on product environmental compliance?**

Email [productcompliance@molex.com](mailto:productcompliance@molex.com)  
 For a multiple part number RoHS Certificate of Compliance, [click here](#)

Please visit the [Contact Us](#) section for any non-product compliance questions.

**Search Parts in this Series**









[74952Series](#)

| VHDM-HSD is a trademark of Amphenol Corporation

This document was generated on 05/28/2010

**PLEASE CHECK [WWW.MOLEX.COM](http://WWW.MOLEX.COM) FOR LATEST PART INFORMATION**

20 19 18 17 16 15 14 13 12 11 10 9 8 7 6 5 4 3 2 1

MATERIAL NUMBER PCB THICKNESS >4.0 - 9.0	MATERIAL NUMBER PCB THICKNESS 18 - 4.0	BUSHING CLOCK POSITION
74952-5901	74952-5001	A 
74952-5902	74952-5002	B 
74952-5903	74952-5003	C 
74952-5904	74952-5004	D 
74952-5905	74952-5005	E 
74952-5906	74952-5006	F 
74952-5907	74952-5007	G 
74952-5908	74952-5008	H 

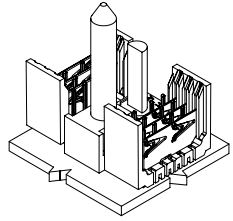
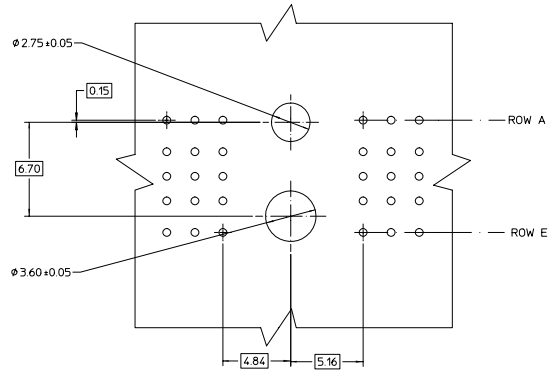
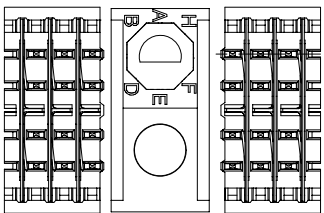

**BILL OF MATERIAL FOR 74952-50\*\***

ITEM	DESCRIPTION	QTY.
1	GUIDE PIN	1
2	GUIDANCE & POLARIZING MODULE	1
3	KEYING PIN	1
4	SCREW & WASHER (PCB 18-4.0)	1

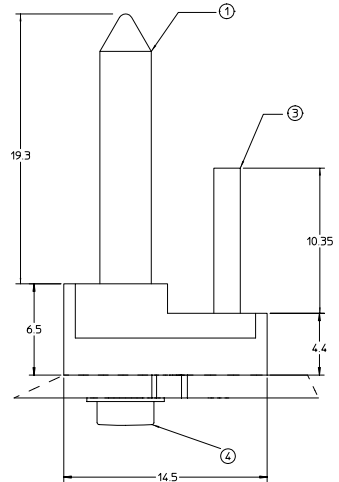
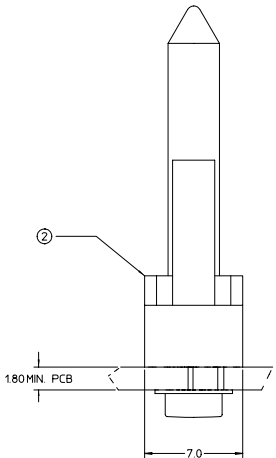

**BILL OF MATERIAL FOR 74952-59\*\***

ITEM	DESCRIPTION	QTY.
1	GUIDE PIN	1
2	GUIDANCE & POLARIZING MODULE	1
3	KEYING PIN	1
4	SCREW & WASHER (PCB >4.0-9.0)	1

- NOTES:
- MATERIAL:  
HOUSING: LIQUID CRYSTAL POLYMER (LCP),  
COLOR: BLACK  
GUIDE PIN / KEYING PIN: STAINLESS STEEL
  - THIS PART CONFORMS TO MOLEX PRODUCT SPECIFICATION PS-74031-999.
  - PACKAGING: STANDARD BULK PACK, 100 PER BAG PACKAGE SCREW SEPARATELY.

EC NO. UDT2002-0216 DRWN: LMSLEY 2001/12/19 CHKD: SREED 2001/12/19 APPR: CBIXLER 2001/12/20	QUALITY SYMBOLS 0 0	GENERAL TOLERANCES (UNLESS SPECIFIED)		SCALE 6:1	DESIGN UNITS METRIC	THIRD ANGLE PROJECTION	REVISE ON CAD ONLY	
		4 PLACES ± --- ± --- 3 PLACES ± --- ± --- 2 PLACES ± --- ± --- 1 PLACE ± --- ± ---	DIMENSION STYLE MM ONLY	DRAWN BY NMARTIN DATE 01/12/11	TITLE BACKPLANE GUIDANCE AND POLARIZING MODULE 5 ROW HSD SALES DRAWING			
		ANGULAR ± 2 °	CHECKED BY SREED DATE 01/12/11	MOLEX MOLEX INCORPORATED				
		DRAFT WHERE APPLICABLE MUST REMAIN WITHIN DIMENSIONS	APPROVED BY CBIXLER DATE 01/12/11	MATERIAL NO. SEE CHART	DOCUMENT NO. SD-74952-002	SHEET NO. 1 OF 1		