

PLEASE CHECK WWW.MOLEX.COM FOR LATEST PART INFORMATION

Part Number: [0436501112](#)
Status: **Active**
Overview: [microfit_30](#)
Description: 3.00mm (.118") Pitch Micro-Fit 3.0™ Header, Surface Mount Compatible, Single Row, Right Angle, with Solder Tab, 11 Circuits, Tin (Sn) Plating, Glow Wire Compatible

Documents:

[3D Model](#) [Product Specification PS-43650 \(PDF\)](#)
[Drawing \(PDF\)](#) [RoHS Certificate of Compliance \(PDF\)](#)

Agency Certification

CSA LR19980
TUV R72081037
UL E29179

General

Product Family PCB Headers
Series [43650](#)
Application Wire-to-Board
Comments High Temperature|Square Pin|Solder Type
Overview [microfit_30](#)
Product Literature Order No USA-106
Product Name Micro-Fit 3.0™

Physical

Breakaway No
Circuits (Loaded) 11
Circuits (maximum) 11
Color - Resin Black
Durability (mating cycles max) 30
Flammability 94V-0
Glow-Wire Compliant Yes
Mated Height (in) 0.275 In
Mated Height (mm) 6.98 mm
Material - Metal Brass
Material - Plating Mating Tin
Material - Plating Termination Tin
Material - Resin High Temperature Thermoplastic
Number of Rows 1
Orientation Right Angle
PCB Locator Yes
PCB Retention Yes
PCB Thickness Recommended (in) 0.062 In
PCB Thickness Recommended (mm) 1.60 mm
Packaging Type Embossed Tape on Reel
Pitch - Mating Interface (in) 0.118 In
Pitch - Mating Interface (mm) 3.00 mm
Plating min: Mating (µin) 100
Plating min: Mating (µm) 2.50
Plating min: Termination (µin) 100
Plating min: Termination (µm) 2.50
Polarized to PCB Yes
Shrouded Fully
Stackable No
Temperature Range - Operating -40°C to +105°C
Termination Interface: Style Surface Mount

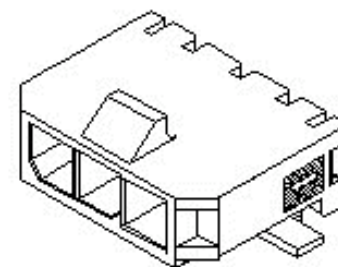

Series

image - Reference only

EU RoHS

ELV and RoHS Compliant
REACH SVHC Contains SVHC: No
Halogen-Free Status
Not Reviewed

China RoHS



Need more information on product environmental compliance?

Email productcompliance@molex.com
For a multiple part number RoHS Certificate of Compliance, [click here](#)

Please visit the [Contact Us](#) section for any non-product compliance questions.

Search Parts in this Series

[43650Series](#)

Mates With

[43645 Micro-Fit 3.0™ Receptacle Housing](#)

Electrical

Current - Maximum per Contact	5A
Voltage - Maximum	250V

Solder Process Data

Duration at Max. Process Temperature (seconds)	30
Lead-free Process Capability	Reflow Capable (SMT only)
Max. Cycles at Max. Process Temperature	3
Process Temperature max. C	260

Material Info**Reference - Drawing Numbers**

Packaging Specification	PK-70873-07**
Product Specification	PS-43650
Sales Drawing	SD-43650-005

This document was generated on 05/24/2010

PLEASE CHECK WWW.MOLEX.COM FOR LATEST PART INFORMATION

13 12 11 10 9 8 7 6 5 4 3 2 1

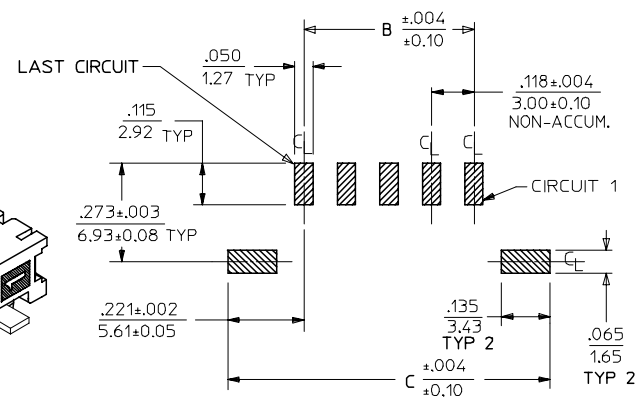
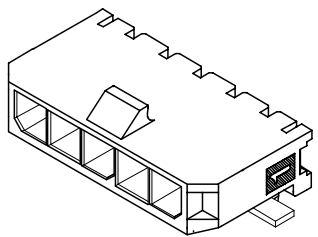
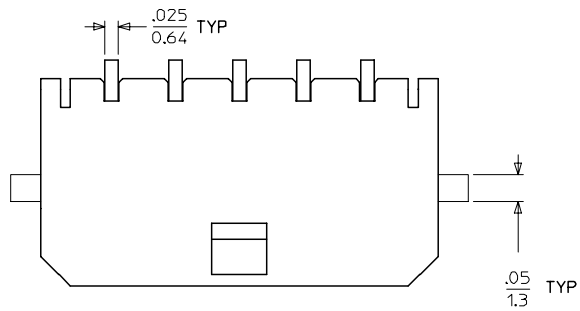

CKTS	A	B	C
2	.380 9.65	.118 3.00	.559 14.20
3	.498 12.65	.236 6.00	.677 17.20
4	.616 15.65	.354 9.00	.795 20.20
5	.734 18.64	.472 12.00	.913 23.20
6	.852 21.64	.591 15.00	1.031 26.20
7	.970 24.64	.709 18.00	1.150 29.20
8	1.088 27.64	.827 21.00	1.268 32.20
9	1.206 30.63	.945 24.00	1.386 35.20
10	1.325 33.66	1.063 27.00	1.504 38.20
11	1.443 36.65	1.181 30.00	1.622 41.20
12	1.561 39.65	1.299 33.00	1.740 44.20

PCB LAYOUT: COMPONENT SIDE

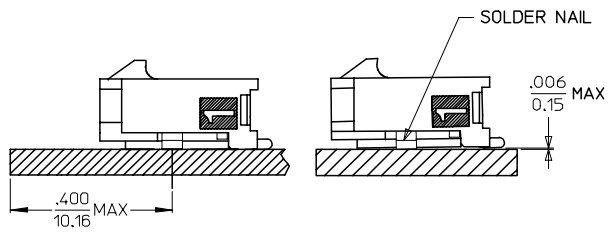
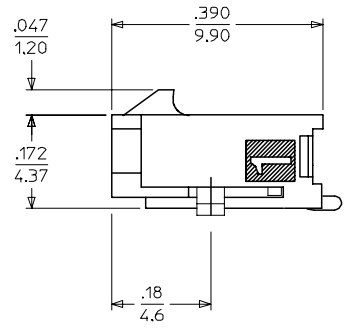
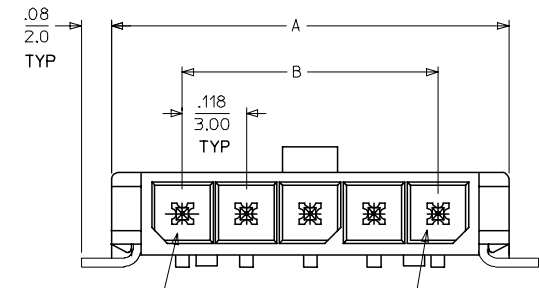

LOCATION DETAIL
SEE NOTE #7

COPLANARITY DETAIL
SEE NOTE #6

NOTES:

CIRCUIT 1

- HOUSING MATERIAL: LIQUID CRYSTAL POLYMER, GLASS FILLED, UL94V-0, COLOR: BLACK
TERMINAL MATERIAL: BRASS ALLOY
- FINISH: A = .000100/(0.00254) MIN. BRIGHT TIN OVER .000050/(0.00127) MIN. NICKEL
B = .000015/(0.00038) MIN. SELECT GOLD IN CONTACT AREA .000100/(0.00254) MIN. SELECT MATTE TIN ON SOLDER TAILS BOTH OVER .000050/(0.00127) NICKEL OVERALL
C = .000030/(0.00076) MIN. SELECT GOLD IN CONTACT AREA .000100/(0.00254) MIN. SELECT MATTE TIN ON SOLDER TAILS BOTH OVER .000050/(0.00127) NICKEL OVERALL
- * THE PRIMARY SHIPPING CARTON WILL BE LABELED "COMPLIANT TO RoHS DIRECTIVE 2002/95/EC AND ELV ANNEX II OF DIRECTIVE 2000/53/EC." CARTONS WITHOUT THIS LABEL MAY CONTAIN PRODUCT WITH TIN/LEAD IN THE PC TAIL AREA.
- PRODUCT SPECIFICATION: PS-43650
- TAPE AND REEL PACKAGED : SEE MOLEX DRAWING PK-70873-07**
- MATES WITH MICRO FIT (3.0) RECEPTACLE SERIES 43645
- THE COPLANARITY DIMENSION IS ESTABLISHED BY PLACING THE ASSEMBLY ON A FLAT SURFACE. THE DISTANCE FROM THAT SURFACE TO THE BOTTOM OF ANY TERMINAL OR NAIL MUST NOT EXCEED .006/0.15
- TO AVOID INTERFERENCE BETWEEN RECEPTACLE AND PCB, HEADER MUST BE PLACED WITHIN .400/(10.16) MAX. FROM EDGE OF PCB, AS SHOWN IN LOCATION DETAIL.
- A HIGHER TEMPERATURE GRADE MATERIAL (260C MAX. REFLOW TEMPERATURE) IS BEING PHASED-IN BEGINNING AUGUST 2007. PARTS WILL BE TEMPORARILY IDENTIFIED WITH A BLUE DOT ON THE PRIMARY SHIPPING CARTON LABEL UNTIL ALL CIRCUIT SIZES ARE CONVERTED. AT WHICH TIME A FULL-CONVERSION DATE WILL BE IDENTIFIED IN PS-43650.

CKTS	FINISH A	FINISH B	FINISH C
	MATERIAL NO:	MATERIAL NO:	MATERIAL NO:
02	43650-0212	43650-0213	43650-0214
03	43650-0312	43650-0313	43650-0314
04	43650-0412	43650-0413	43650-0414
05	43650-0512	43650-0513	43650-0514
06	43650-0612	43650-0613	43650-0614
07	43650-0712	43650-0713	43650-0714
08	43650-0812	43650-0813	43650-0814
09	43650-0912	43650-0913	43650-0914
10	43650-1012	43650-1013	43650-1014
11	43650-1112	43650-1113	43650-1114
12	43650-1212	43650-1213	43650-1214

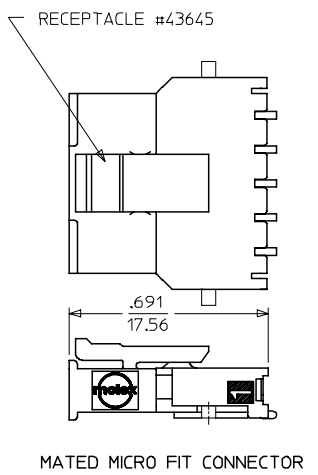

ADD NOTES 7 AND 8 EC NO: UCP2008-0037 DRAWN BY: IPPER 2007/09/06 CHKD: SSOUSEK 2007/09/11 APPR: FSM TH 2007/09/12	QUALITY SYMBOLS ▽=0 ▽=0	GENERAL TOLERANCES (UNLESS SPECIFIED)		DIMENSION STYLE IN/MM		SCALE ---	DESIGN UNITS METRIC	THIRD ANGLE PROJECTION
		4 PLACES ± --- ± --- 3 PLACES ± --- ± .010 2 PLACES ± 0.25 ± .014 1 PLACE ± 0.36 ± ---		DRAWN BY: SAMIEC DATE: 2000/07/07 CHECKED BY: MUELLER DATE: 2000/07/07 APPROVED BY: EDGLEY DATE: 2000/07/07				
		ANGULAR ±1/2°		MATERIAL NO. SEE CHART				
		DRAFT WHERE APPLICABLE MUST REMAIN WITHIN DIMENSIONS		DOCUMENT NO. SD-43650-005				

MICRO FIT (3.0)
SINGLE ROW / RIGHT ANGLE
SMT / NAILS / REELS
MOLEX INCORPORATED
SHEET NO. 1 OF 1

12 11 10 9 8 7 6 5 4 3 2 1